

SALAMANDER
DESIGNS

REFERENCE GUIDE





FURNITURE
SHAPED BY YOUR NEEDS®



SALAMANDER DESIGNS

For over 25 years, Salamander Designs has been designing and manufacturing high-quality, customizable AV furniture.

"Salamander furniture is shaped by your needs"

We specialize in offering exceptional choice when shopping for functional products that integrate technology with your lifestyle.

We take pride that we build best-of-class AV furniture. Our Design Your Own concept allows Salamander customers to bring their personal visions to life.

Our approach to furniture manufacturing blends a specific design philosophy that fuses visual design, engineering and craftsmanship.

"Salamander systems start with a strong foundation"

And our products are Engineered to Perform, designed to enhance and evolve with changing technology needs and preferences.

Salamander Designs ... Elevating the Furniture Experience.



Sustainability is part of our DNA. We build things to last a lifetime. And we strive to tread lightly on our environment, from the materials we select, to manufacturing processes we employ, to our **100% solar powered factory**.



Throughout our history, we have been committed to building as many of our products as possible in the USA.



For 16 years straight Salamander leads the furniture category, according to CE Pro Magazine.



Our business is fueled by a passionate commitment to create the highest quality AV furniture on the market, shaped by the needs of our customers.

Salvatore Carrabba - Founder





6 AV Furniture

- 14 Chameleon Collection (C-Frame)
 - 32 Barcelona
 - 36 Berlin
 - 38 Chicago
 - 40 Corsica
 - 42 Denver
 - 46 Elba
 - 48 Hampton
 - 50 Lancaster
 - 52 Miami
 - 54 Milan
 - 56 Oslo
 - 58 Seattle
 - 60 Sonoma
 - 62 Venice
 - 64 Zurich

- 66 Synergy System (S-Frame)
- 82 Synergy Solutions
- 85 Synergy Pro Audio Racks
- 90 Archetype System (A-Frame)

93 AV Furniture Accessories

- 94 TV Integration
- 95 Speaker Integration
- 96 Interior Storage
- 97 Shelves
- 97 In-Cabinet Refrigerator
- 99 Pro Rack Mounting
- 100 Active Cooling & Rear Panels
- 101 Integrated Power
 - Power Conditioner
 - Power Distributor Unit
- 102 Footing
- 103 Wall Mount Kits
- 104 Accent Lighting
- 104 IR Repeater
- 104 Security Locks & Rears

105 Saddle iPad Holder

106 Custom Seating

- 114 Luca
- 116 Lilliana
- 118 Isabella
- 120 Olivia
- 122 Talia
- 124 Matteo
- 126 Alex
- 128 Tables, Ottomans & Accessories

130 AV Basics

- 132 AV Cabinets
- 134 Theater Seating

136 TV Mounts

- 137 Projector Mount
- 137 Motorized Mounts
- 137 Wall Mounts
- 94 Cabinet Integrated Mount

138 Office Collaboration Workspace Solutions

141 Product Warranties

LUCA & LILLIANA SEATING



NOW AVAILABLE IN
PREMIUM ALABASTER
LUXE LEATHER



Lilliana Seating in Luxe Premium Leather, Onyx with Oyster Piping

AV FURNITURE

Audio Video cabinets are essentially the control center for any media room's AV components. At Salamander, we don't build custom cabinets just to house and support your TV—but everything that comes with it. Every facet of our design process serves a purpose, from vibration damping construction and cabinet ventilation to cable management and storage options.



Corisca 339

DESIGN YOUR OWN

YOUR FURNITURE HELPS DEFINE YOUR SPACE



You may prefer a sleek contemporary look, or something more traditional. Having choices - being able to Design Your Own - is essential in finding the perfect furniture to match your decor. That is why we offer a wide range of style options and features, like exotic Wenge finish, textured natural wood doors, or high-gloss black glass for dramatic effect. And whether your cabinet is wall-mounted or “grounded” with stylish footings, you’ll find the perfect AV furniture solution.



Seattle 237

ON-WALL

The wall hanging cabinet is the ultimate way to create the look of custom cabinetry. It creates the illusion that your cabinet is floating above the floor. Best of all, installation is simple. Just remove the standard cabinet feet, install the specialized wall hanging brackets and presto. See wall bracket on Page 103.



Elba 247



Zurich 245



Chicago 245

FIT YOUR STYLE & SPACE

Decorator feet and wheels fine tune the style and functional.



Miami 247 on Tube Base



ENGINEERED TO PERFORM

THE ESSENTIAL FUNCTION

Salamander produces specialized AV furniture and accessories that are Engineered To Perform - designed to satisfy the functional requirements of both professional AV integrators and AV enthusiasts. Keen attention to the smallest details result in a heightened audio visual experience.

Thoughtful technology solutions such as our cabinet cooling features increase the performance and longevity of electronic components. Additionally, all cabinets feature Interior **Storage options, Cooling, IR Passing, Removable Rears** and **Interior Cable Raceways, Integrating TV's or Speakers** into the cabinet.

SPEAKER INTEGRATION

AV Cabinets accommodate a wide range of speaker types and sizes. Salamander has partnered with Leon Speakers to offer custom-made premium soundbars to fit most Salamander cabinets. These center channel and LCR speakers are designed specifically to fit any cabinet.



Synergy 236, Cherry/Black



Synergy 329, Cherry/Black



BUILT TO LAST

NOBODY BUILDS FURNITURE LIKE WE DO

At Salamander, we build things to last a lifetime, utilizing the finest, **sustainable materials** and **cutting edge construction** methods. We pay close attention to each component for its balance of function, durability, comfort and style. The **structural integrity** and **flexibility** of our systems are of utmost importance, and nowhere is this better illustrated than looking inside to the heart of each custom cabinet - a **precision-engineered** aluminium frame that puts us in a class by ourselves. All finished customized AV furniture is **built-to-order in the USA** and carries a **lifetime warranty**.



TECH RACK

Now, for the first time, it is possible to own Pro Audio Rack Mount cabinets that look like furniture.

All rack mount cabinets are constructed of premium components with exceptional attention to detail, reliability and durability. Mounting rails are compatible with industry EIA 19" component standards and include lacing bars to help manage wires.





CHAMELEON SYSTEM

Chameleon combines art and technology in sophisticated designs to fit in almost any decor.

CHAMELEON SYSTEM STYLES



*MULTIPLE TOP
OPTIONS AVAILABLE



FABRICATE YOUR OWN SKINS
Ask about our frame only option.



BARCELONA GLASS
Natural Walnut, Black Glass
Doors, Beveled Edge Top



BARCELONA WHITE
Natural Walnut, Warm White
Doors, Beveled Edge Top



BERLIN*
Wenge, Wave-Texture Doors,
with Black, Glass Top



CHICAGO*
Black Oak, Grass-Textured
with Black, Glass Top



CORSICA
American Cherry, Wood Rail &
Stile, Smoke Glass Door
with Hidden Finger Pull



DENVER - OAK*
Natural Oak, Bark-Textured
with Black, Glass Top



DENVER - WALNUT*
Medium Walnut, Bark-Textured
with Black, Glass Top



ELBA
American Cherry
Rail & Stile, Smoke Glass Door



HAMPTON
Distressed Black, Raised
Panel with Wood Knob



LANCASTER
Textured Barn Board Top,
Doors, and Side Panel



MIAMI*
Gloss Warm White Door,
with Black, Glass Top



MILAN*
Geometric Three-Dimensional,
Diamond Pattern, Black Glass Top



OSLO*
Wenge Sides, Black, Glass
Doors with Black, Glass Top



SEATTLE*
Alpi Gray Oak, Vertical Grass
Textured with Black, Glass Top



SONOMA
American Cherry
Mullions & Black Perf. Metal Door



VENICE
Antique Cherry, Miter Frame
and Panel Doors with Aged
Brass Knobs



ZURICH*
Opium Brown, Linear Textured
with Black, Glass Top



CHAMELEON AV CABINETS

Underneath the hood is the C-frame, a unique aluminum chassis that provides a strong and flexible furniture platform. Expertly finished furniture panels are attached to the C-frame to create various styles, and the internal chassis permits a wide variety of bolt-on options and accessories.



Denver Oak 247

Pinch-Out Rears
permit fast, easy access to components and wiring.

Customize Interiors



Extruded Aluminum Frame
create a support skeleton.

Ventilation
Built-in louvers for better air flow to keep equipment cool.



Soft-Close Doors

Infinitely Adjustable Shelves

Customize
with designer feet,
wheels or mount on wall

Wire Management

CHAMELEON AV CABINETS

A - Single-Width Compartment

19.75"W x 19.5"D x 17.75"H

A1 - Subwoofer Compartment

19.75"W x 19.5"D x 17.75"H

B - Single-Width Compartment

19.75"W x 19.5"D x 27.75"H

C - Media Drawer

18.625"W x 18"D x 7.75"H
holds 75 DVD's and or 111 CD's

D - Single-Width Center Speaker / Multi-Functional Compartment

19.75"W x 19.5"D x 9"H

G - Double-Width Center Speaker / Multi-Functional Compartment

40.5"W x 19.5"D x 9"H

F - Triple-Width Center Speaker / Multi-Functional Compartment

61.25"W x 19.5"D x 9"H

H - Double-Width Center Speaker / Multi-Functional Compartment

40.5"W x 19.5"D x 8.15"H

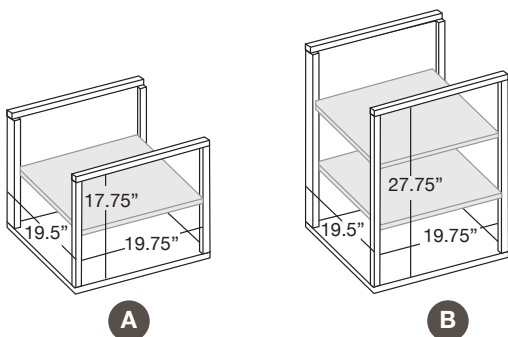

AUDIO CABINETS



217



317



517



617

AUDIO VIDEO CABINETS



221

*TV Size: up to 50"



323

*TV Size: up to 50"



237

*TV Size: up to 75"



337

*TV Size: up to 75"



247

*TV Size: up to 90"



347

*TV Size: up to 90"

SPEAKER INTEGRATED AV CABINETS – Includes Speaker Grill



329

*TV Size: up to 50"



326

*TV Size: up to 75"

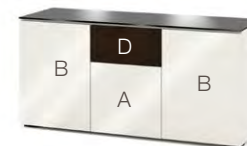

336

*TV Size: up to 75"



339

*TV Size: up to 75"



217

SUBWOOFER ENCLOSURE



245

*TV Size: up to 90"



345

*TV Size: up to 90"



CHAMELEON PROJECTOR CABINETS

A simple installation with no need to open the wall or ceiling to run cables. All supporting components including a speaker system can be enclosed in the credenza to provide a beautiful and simple solution.

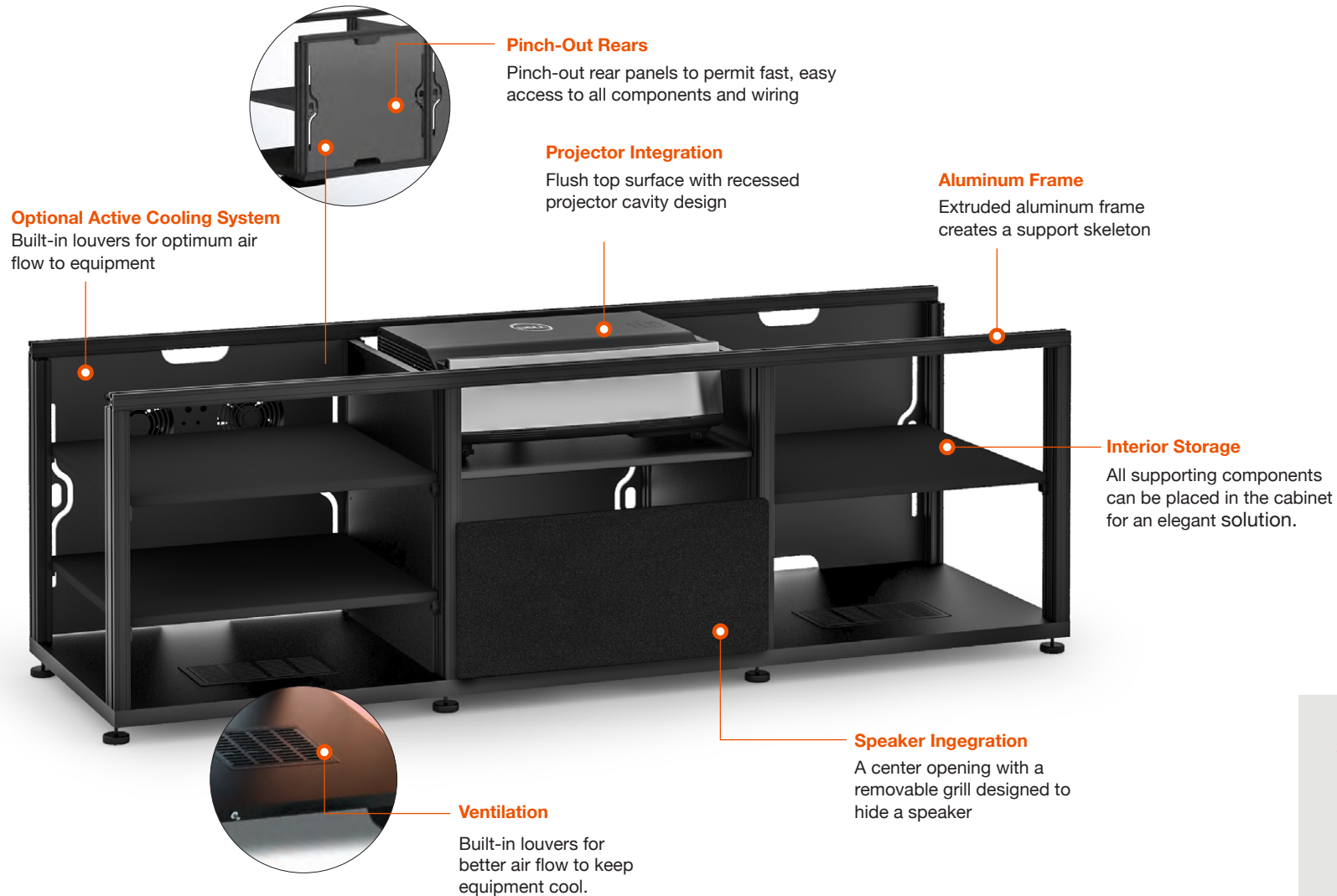

Optional Active Cooling System
Built-in louvers for optimum air flow to equipment

Pinch-Out Rears

Pinch-out rear panels to permit fast, easy access to all components and wiring

Projector Integration

Flush top surface with recessed projector cavity design

Aluminum Frame

Extruded aluminum frame creates a support skeleton

Interior Storage

All supporting components can be placed in the cabinet for an elegant solution.

Speaker Ingegration

A center opening with a removable grill designed to hide a speaker

Ventilation

Built-in louvers for better air flow to keep equipment cool.

Advanced Accessories

- IR repeater system required to control projector
- Variety of bolt-on options and accessories are also available

SEAMLESS INTEGRATION FOR EVERY BRAND AND PROJECT

SONY



* SONY Projector Cabinet is available in Miami, Oslo and Chicago only.

Hisense

Model: 100L8D, 100L10E, 120L10E, 150L10E



EPSON

Model: LS100



vivitek
Vivid Color. Vivid Life

Model: DH765Z-UST, DW763Z-UST



DESIGNER STYLES

We select the finest materials and finishes. Choose from sleek, hand-polished, high-gloss finishes to richly textured real wood fronts with a mix of materials.



OSLO*

Wenge Sides, Black, Glass Doors with Glass Top



CHICAGO*

Black Oak, Grass-Textured with Glass Top



MILAN

Geometric Three-Dimensional, Diamond Pattern, Glass Top



MIAMI*

Gloss Warm White Door, with Brown, Glass Top



SEATTLE*

Alpi Gray Oak, Vertical Grass Textured with Black, Glass Top



BERLIN

Wenge, Wave-Texture Doors, with Glass Top



ZURICH

Opium Brown, Linear Textured with Glass Top



DENVER - WALNUT

Medium Walnut, Bark-Textured with Glass Top



DENVER - OAK

Natural Oak, Bark-Textured with Glass Top



CHAMELEON PRO AUDIO RACKS

All rack mount cabinets are constructed of premium components with exceptional attention to detail, reliability and durability. Mounting rails are compatible with industry EIA 19" component standards and include lacing bars to help manage wires.

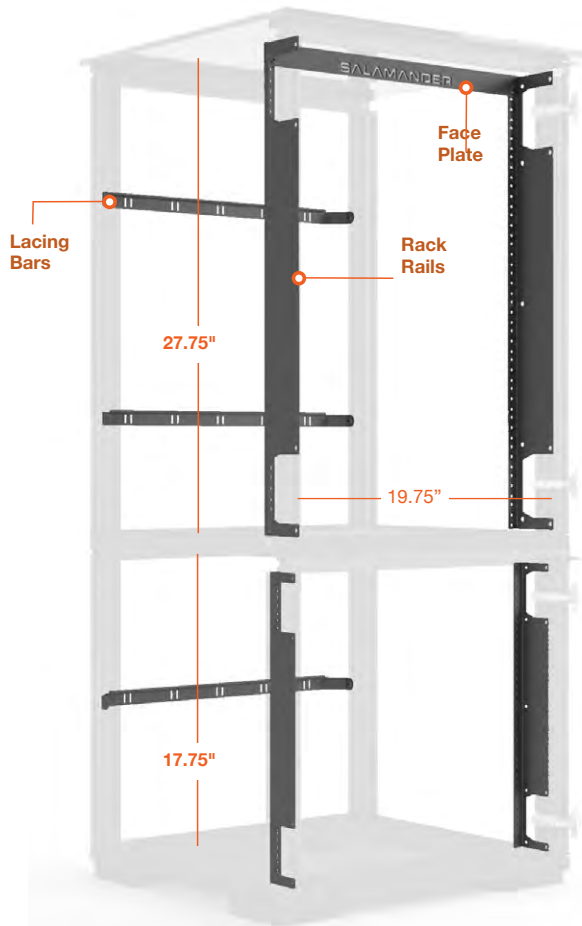

323RM
30 Rack Units
4 Lacing Bars



317RM
15 Rack Units
2 Lacing Bars



517RM
25 Rack Units
3 Lacing Bars



617RM
30 Rack Units
4 Lacing Bars

A2 19.75"W x 17.75"D x 17.75"H

B2 19.75"W x 19.5"D x 27.75"H

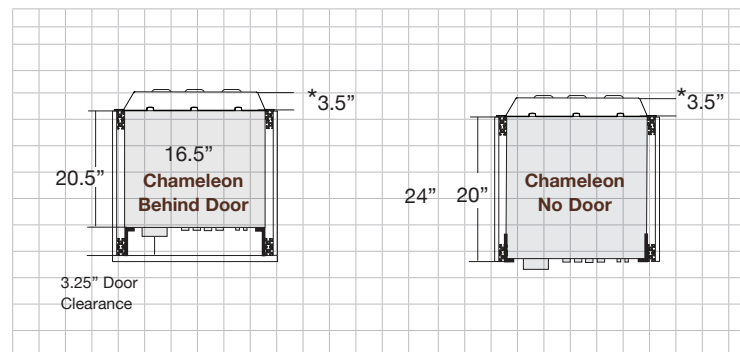

RETRO-FIT RAILS

Choose a dedicated Pro Audio Rack or retro-fit rails (Page 98) with adjustable shelves.





CHAMELEON CORNER AV CABINETS

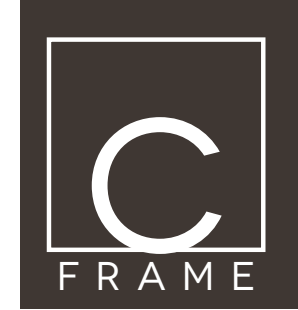

Accommodating smaller spaces, our Corner Cabinets open up possibilities in a variety of living spaces. Corner Units available in three configurations and all Chameleon Styles.



221 CORNER
Rec. TV Size: up to 50"



323 CORNER
Rec. TV Size: up to 50"



329 CORNER
Rec. TV Size: up to 50"
Includes Speaker Grill

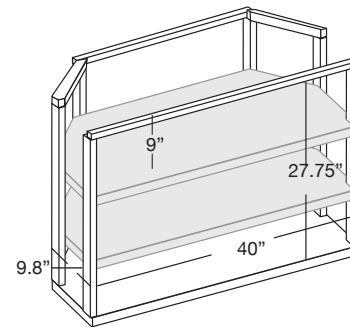
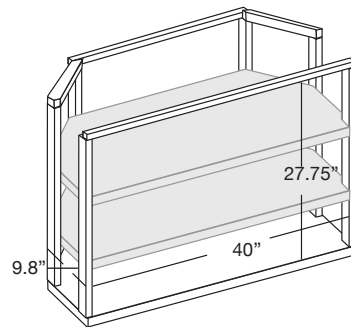
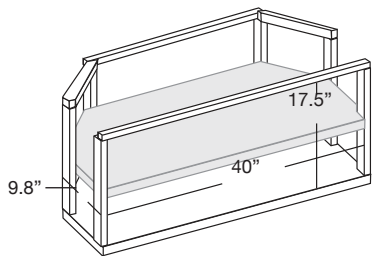

*CORNER INTERIOR

- 40" wide x 10" deep
- 32" wide x 14" deep
- 19" wide x 20" deep

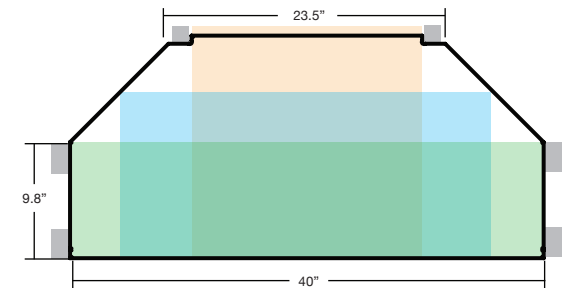

*CORNER EXTERIOR

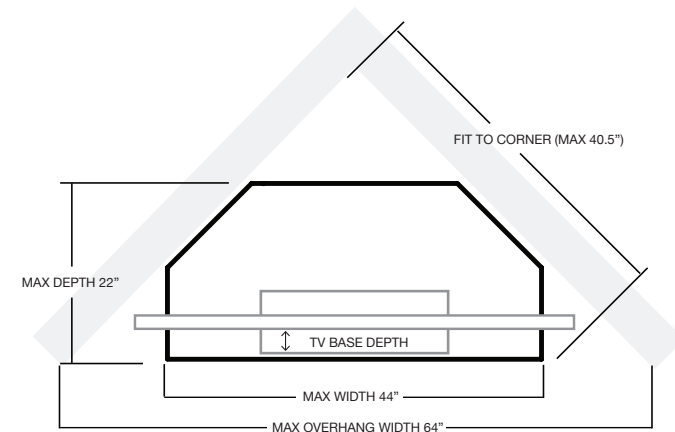

TV SIZING:

For every 1" of depth required by the TV base, subtract 1.8 from 64. This is the MAX TV width at the required depth. Note: Minor gains can be had by moving cabinet forward. This will cause a gap but will produce 1.8" in width per inch moved forward.

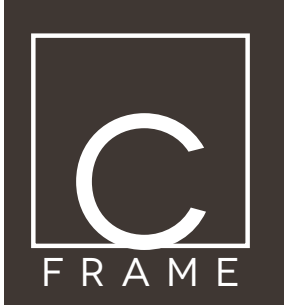

CHAMELEON LOW PROFILE AV CABINETS

Low-profile, shallow depth cabinets are sleek, streamlined solutions for supporting AV technology. Our innovative design conceals all equipment and cables, and simple installation allows them to be affixed to any wall without special preparation.

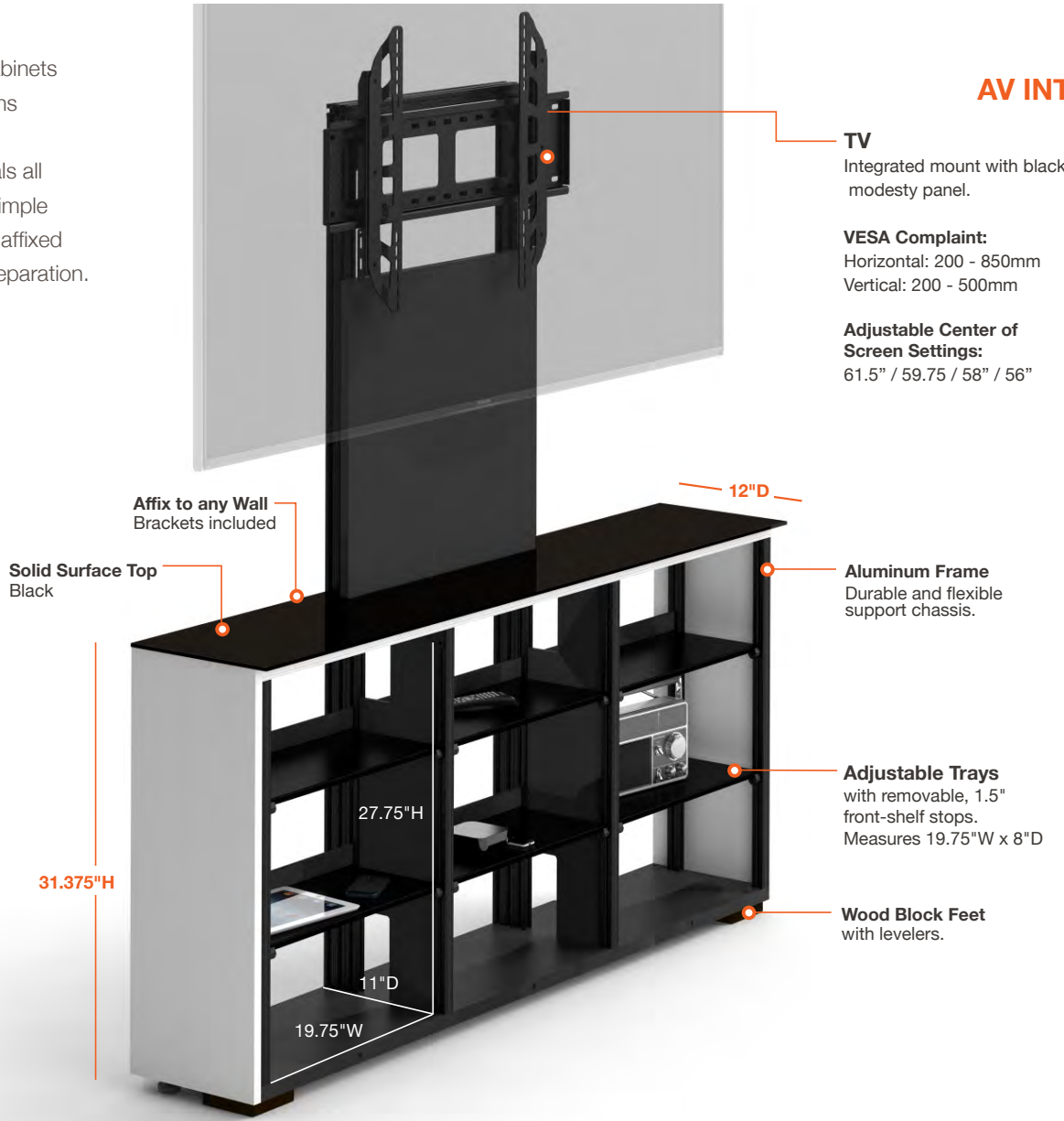

AV INTEGRATION

TV
Integrated mount with black modesty panel.

VESA Compliant:
Horizontal: 200 - 850mm
Vertical: 200 - 500mm

Adjustable Center of Screen Settings:
61.5" / 59.75" / 58" / 56"

Speaker
Model 345 features a center opening with a removable, grill designed to hide a speaker.



See our integrated Premium Soundbars (page 95)

Affix to any Wall Brackets included

Solid Surface Top Black

12"D

Aluminum Frame
Durable and flexible support chassis.

31.375"H

27.75"H

Adjustable Trays
with removable, 1.5" front-shelf stops. Measures 19.75"W x 8"D

11"D

19.75"W

Wood Block Feet
with levelers.

3-U VERTICAL RACK

Optional Vertical Rack mounts (Page 99) to cabinet frame, for industry standard 19"



CHAMELEON LOW PROFILE AV CABINETS

Simple installation. Affix to wall with toggle bolts.

Interior Dimensions

A3 19.75"W x 11"D x 17.75"H

B3 19.75"W x 11"D x 27.75"H

G3 40.5"W x 11"D x 9"H



Low Profile 337

64.75"W x 31.375"H x 12"D



Low Profile 347

88"W x 31.375"H x 12"D



Low Profile 345

88"W x 31.375"H x 12"D

Speaker Compartment: 40"W x 11"D x 9"H



Low Profile 337 With TV Mount

64.75"W x 31.375"H x 12"D

Holds 50-70" TV's, 175 lbs (80kg)



Low Profile 347 With TV Mount

85.5"W x 31.375"H x 12"D

Holds 50-103" TV's, 175 lbs (80kg)



Low Profile 345 with TV Mount

85.5"W x 31.375"H x 12"D

Holds 50-103" TV's, 175 lbs (80kg)

Speaker Compartment: 40"W x 11"D x 9"H



CHAMELEON CUSTOM INTERIORS



STORING

Our personal electronics storage is a great all-in-one organizational space storing remotes and other media devices.

MULTI-FUNCTION

Solidly built, these multi-functional pull-out shelves are specifically designed to support turntables and other heavy equipment.

CHARGING

Conveniently charge and store your mobile devices in our pull-out trays. Now there really is a place for everything.

PRO AUDIO

Cabinets can be outfitted with Rack Mounting Rails that allows integration of professional equipment, conforming to EIA 19" rack standards.

CHAMELEON ACCESSORIES



All of our advanced accessories have been designed to enhance the functional or aesthetic aspects of our furniture systems. Each one has been built to our exacting standards for quality, reliability and durability to provide years of trouble-free operation.



Top Panel Surfaces

choose between tempered glass and solid surface in a variety of colors



Decorator Feet and Wheels

fine tune the style and function



Active Cooling

system protects delicate electronics



Power Conditioning

delivers better picture and sound



IR Repeater

allows remote controls to operate through solid doors



Accent Light

sets the mood and adds light just where you need it





**BARCELONA
WHITE**



**BARCELONA
BLACK GLASS**



BERLIN



CHICAGO



CORSICA



**DENVER
NATURAL OAK**



**DENVER
NATURAL WALNUT**



ELBA

LOW PROFILE CABINETS - See interior dimensions on page 23.

337 Low-Profile Cabinet			C1/BL337/WE 64.75"W x 31.375"H x 12"D	C1/CH337/BO 64.75"W x 31.375"H x 12"D		C1/DV337/NO 64.75"W x 31.375"H x 12"D	C1/DV337/MW 64.75"W x 31.375"H x 12"D	
337 Low-Profile Cabinet with TV Mount			C1/BL337M/WE 64.75"W x 31.375"H x 12"D	C1/CH337M/BO 64.75"W x 31.375"H x 12"D		C1/DV337M/NO 64.75"W x 31.375"H x 12"D	C1/DV337M/MW 64.75"W x 31.375"H x 12"D	
345 Low-Profile, Wall Cabinet			C1/BL345/WE 85.5"W x 31.375"H x 12"D	C1/CH345/BO 85.5"W x 31.375"H x 12"D		C1/DV345/NO 85.5"W x 31.375"H x 12"D	C1/DV345/MW 85.5"W x 31.375"H x 12"D	
345 Low-Profile Cabinet with TV Mount			C1/BL345M/WE 85.5"W x 31.375"H x 12"D	C1/CH345M/BO 85.5"W x 31.375"H x 12"D		C1/DV345M/NO 85.5"W x 31.375"H x 12"D	C1/DV345M/MW 85.5"W x 31.375"H x 12"D	
347 Low-Profile Cabinet			C1/BL347/WE 85.5"W x 31.375"H x 12"D	C1/CH347/BO 85.5"W x 31.375"H x 12"D		C1/DV347/NO 85.5"W x 31.375"H x 12"D	C1/DV347/MW 85.5"W x 31.375"H x 12"D	
347 Low-Profile Cabinet with TV Mount			C1/BL347M/WE 85.5"W x 31.375"H x 12"D	C1/CH347M/BO 85.5"W x 31.375"H x 12"D		C1/DV347M/NO 85.5"W x 31.375"H x 12"D	C1/DV347M/MW 85.5"W x 31.375"H x 12"D	

AUDIO & AV CABINET - See interior dimensions on page 17.

217 Audio Cabinet	C/BA217/NW/GW 24.25"W x 24.75"H x 22"D	C/BA217/NW/BG 24.25"W x 24.75"H x 22"D	C/BL217/WE 23.25"W x 21.5"H x 21.25"D	C/CH217/BO 25.75"W x 22.5"H x 21.25"D	C/CO217/AC 23.25"W x 21.5"H x 21.25"D	C/DV217/NO 23.25"W x 21.5"H x 21.25"D	C/DV217/MW 23.25"W x 21.5"H x 21.25"D	C/EL217/AC 23.25"W x 24.5"H x 21.25"D
317 Audio Cabinet	C/BA317/NW/GW 24.25"W x 34.5"H x 22"D	C/BA317/NW/BG 24.25"W x 34.5"H x 22"D	C/BL317/WE 23.25"W x 31.25"H x 21.25"D	C/CH317/BO 25.75"W x 32"H x 21.25"D	C/CO317/AC 23.25"W x 31.25"H x 21.25"D	C/DV317/NO 23.25"W x 31.25"H x 21.25"D	C/DV317/MW 23.25"W x 31.25"H x 21.25"D	
517 Audio Cabinet	C/BA517/NW/GW 24.25"W x 54.75"H x 22"D	C/BA517/NW/BG 24.25"W x 54.75"H x 22"D	C/BL517/WE 23.25"W x 50.875"H x 21.25"D	C/CH517/BO 25.75"W x 50.875"H x 21.25"D	C/CO517/AC 23.25"W x 50.875"H x 21.25"D	C/DV517/NO 23.25"W x 50.875"H x 21.25"D	C/DV517/MW 23.25"W x 50.875"H x 21.25"D	C/EL517/AC 23.25"W x 53.625"H x 21.25"D
617 Audio Cabinet	C/BA617/NW/GW 24.25"W x 64.5"H x 22"D	C/BA617/NW/BG 24.25"W x 64.5"H x 22"D	C/BL617/WE 23.25"W x 60.625"H x 21.25"D	C/CH617/BO 25.75"W x 60.625"H x 21.25"D	C/CO617/AC 23.25"W x 60.625"H x 21.25"D	C/DV617/NO 23.25"W x 60.625"H x 21.25"D	C/DV617/MW 23.25"W x 60.625"H x 21.25"D	C/EL617/AC 23.25"W x 63.25"H x 21.25"D
221 AV Cabinet	C/BA221/NW/GW 45"W x 24.75"H x 22"D	C/BA221/NW/BG 45"W x 24.75"H x 22"D	C/BL221/WE 44"W x 21.5"H x 21.25"D	C/CH221/BO 46.5"W x 22.5"H x 21.25"D	C/CO221/AC 44"W x 21.5"H x 21.25"D	C/DV221/NO 44"W x 21.5"H x 21.25"D	C/DV221/MW 44"W x 21.5"H x 21.25"D	C/EL221/AC 44"W x 24.5"H x 21.25"D
323 AV Cabinet	C/BA323/NW/GW 45"W x 34.5"H x 22"D	C/BA323/NW/BG 45"W x 34.5"H x 22"D	C/BL323/WE 44"W x 31.375"H x 21.25"D	C/CH323/BO 44"W x 31.375"H x 21.25"D	C/CO323/AC 44"W x 31.25"H x 21.25"D	C/DV323/NO 44"W x 31.375"H x 21.25"D	C/DV323/MW 44"W x 31.375"H x 21.25"D	C/EL323/AC 44"W x 33.75"H x 21.25"D
237 AV Cabinet	C/BA237/NW/GW 65.75"W x 24.75"H x 22"D	C/BA237/NW/BG 65.75"W x 24.75"H x 22"D	C/BL237/WE 64.75"W x 21.5"H x 21.25"D	C/CH237/BO 67.25"W x 22.5"H x 21.25"D	C/CO237/AC 64.75"W x 21.5"H x 21.25"D	C/DV237/NO 64.75"W x 21.5"H x 21.25"D	C/DV237/MW 64.75"W x 21.5"H x 21.25"D	C/EL237/AC 64.75"W x 24.5"H x 21.25"D
247 AV Cabinet	C/BA247/NW/GW 86.5"W x 24.75"H x 22"D	C/BA247/NW/BG 85.5"W x 24.75"H x 22"D	C/BL247/WE 85.5"W x 21.5"H x 21.25"D	C/CH247/BO 88"W x 22.5"H x 21.25"D	C/CO247/AC 85.5"W x 21.5"H x 21.25"D	C/DV247/NO 85.5"W x 21.5"H x 21.25"D	C/DV247/MW 85.5"W x 21.5"H x 21.25"D	C/EL247/AC 85.5"W x 24.5"H x 21.25"D
337 AV Cabinet	C/BA337/NW/GW 65.75"W x 34.5"H x 22"D	C/BA337/NW/BG 65.75"W x 34.5"H x 22"D	C/BL337/WE 64.75"W x 31.375"H x 21.25"D	C/CH337/BO 67.25"W x 32"H x 21.25"D	C/CO337/AC 64.75"W x 31.375"H x 21.25"D	C/DV337/NO 64.75"W x 31.375"H x 21.25"D	C/DV337/MW 64.75"W x 31.375"H x 21.25"D	C/EL337/AC 64.75"W x 33.75"H x 21.25"D
347 AV Cabinet	C/BA347/NW/GW 86.5"W x 34.5"H x 22"D	C/BA347/NW/BG 85.5"W x 34.5"H x 22"D	C/BL347/WE 85.5"W x 31.375"H x 21.25"D	C/CH347/BO 88"W x 32"H x 21.25"D	C/CO347/AC 85.5"W x 31.375"H x 21.25"D	C/DV347/NO 85.5"W x 31.375"H x 21.25"D	C/DV347/MW 85.5"W x 31.375"H x 21.25"D	C/EL347/AC 85.5"W x 33.75"H x 21.25"D



HAMPTON LANCASTER MIAMI MILAN OLSO SEATTLE SONOMA VENICE ZURICH

	C1/LA337/BBO 64.75"W x 31.75"H x 12"D	C1/MM337/GW/BK 64.75"W x 31.375"H x 12"D		C1/OS337/BG 64.75"W x 31.375"H x 12"D	C1/SE337/GO 64.75"W x 31.375"H x 12"D			C1/ZU337/OB 64.75"W x 31.375"H x 12"D
	C1/LA337M/BBO 64.75"W x 31.75"H x 12"D	C1/MM337M/GW/BK 64.75"W x 31.375"H x 12"D		C1/OS337M/BG 64.75"W x 31.375"H x 12"D	C1/SE337M/GO 64.75"W x 31.375"H x 12"D			C1/ZU337M/OB 64.75"W x 31.375"H x 12"D
	C1/LA345/BBO 85.5"W x 31.75"H x 12"D	C1/MM345/GW/BK 85.5"W x 31.375"H x 12"D		C1/OS345/BG 85.5"W x 31.375"H x 12"D	C1/SE345/GO 85.5"W x 31.375"H x 12"D			C1/ZU345/OB 85.5"W x 31.375"H x 12"D
	C1/LA345M/BBO 85.5"W x 31.75"H x 12"D	C1/MM345M/GW/BK 85.5"W x 31.375"H x 12"D		C1/OS345M/BG 85.5"W x 31.375"H x 12"D	C1/SE345M/GO 85.5"W x 31.375"H x 12"D			C1/ZU345M/OB 85.5"W x 31.375"H x 12"D
	C1/LA347/BBO 85.5"W x 31.75"H x 12"D	C1/MM347/GW/BK 85.5"W x 31.375"H x 12"D		C1/OS347/BG 85.5"W x 31.375"H x 12"D	C1/SE347/GO 85.5"W x 31.375"H x 12"D			C1/ZU347/OB 85.5"W x 31.375"H x 12"D
	C1/LA347M/BBO 85.5"W x 31.75"H x 12"D	C1/MM347M/GW/BK 85.5"W x 31.375"H x 12"D		C1/OS347M/BG 85.5"W x 31.375"H x 12"D	C1/SE347M/GO 85.5"W x 31.375"H x 12"D			C1/ZU347M/OB 85.5"W x 31.375"H x 12"D
	C/LA217/BBO 23.25"W x 21.75"H x 21.25"D	C/MM217/GW/BK 23.25"W x 21.5"H x 21.25"D	C/ML217/WH/BK 23.25"W x 21.5"H x 21.25"D	C/OS217/BG 23.25"W x 21.5"H x 21.25"D	C/SE217/GO 23.25"W x 21.5"H x 21.25"D	C/SO217/AC 23.25"W x 24.5"H x 21.25"D		C/ZU217/OB 23.25"W x 21.5"H x 21.25"D
	C/LA317/BBO 23.25"W x 31.75"H x 21.25"D	C/MM317/GW/BK 23.25"W x 31.25"H x 21.25"D	C/ML317/WH/BK 23.25"W x 31.25"H x 21.25"D	C/OS317/BG 23.25"W x 31.25"H x 21.25"D	C/SE317/GO 23.25"W x 31.25"H x 21.25"D	C/SO317/AC 23.25"W x 33.75"H x 21.25"D		C/ZU317/OB 23.25"W x 31.25"H x 21.25"D
	C/LA517/BBO 23.25"W x 51.25"H x 21.25"D	C/MM517/GW/BK 23.25"W x 50.875"H x 21.25"D	C/ML517/WH/BK 23.25"W x 50.875"H x 21.25"D	C/OS517/BG 23.25"W x 50.875"H x 21.25"D	C/SE517/GO 23.25"W x 50.875"H x 21.25"D	C/SO517/AC 23.25"W x 53.625"H x 21.25"D		C/ZU517/OB 23.25"W x 50.875"H x 21.25"D
	C/LA617/BBO 23.25"W x 61"H x 21.25"D	C/MM617/GW/BK 23.25"W x 60.625"H x 21.25"D	C/ML617/WH/BK 23.25"W x 60.625"H x 21.25"D	C/OS617/BG 23.25"W x 60.625"H x 21.25"D	C/SE617/GO 23.25"W x 60.625"H x 21.25"D	C/SO617/AC 23.25"W x 63.25"H x 21.25"D		C/ZU617/OB 23.25"W x 60.625"H x 21.25"D
C/HA221/DB 45.25"W x 24.5"H x 21.75"D	C/LA221/BBO 44"W x 21.75"H x 21.25"D	C/MM221/GW/BK 44"W x 21.5"H x 21.25"D	C/ML221/WH/BK 44"W x 21.5"H x 21.25"D	C/OS221/BG 44"W x 21.5"H x 21.25"D	C/SE221/GO 44"W x 21.5"H x 21.25"D	C/SO221/AC 44"W x 24.5"H x 21.25"D		C/ZU221/OB 44"W x 21.5"H x 21.25"D
	C/LA323/BBO 44"W x 31.75"H x 21.25"D	C/MM323/GW/BK 44"W x 31.375"H x 21.25"D	C/ML323/WH/BK 44"W x 31.375"H x 21.25"D	C/OS323/BG 44"W x 31.375"H x 21.25"D	C/SE323/GO 44"W x 31.375"H x 21.25"D	C/SO323/AC 44"W x 33.75"H x 21.25"D		C/ZU323/OB 44"W x 31.375"H x 21.25"D
C/HA237/DB 66"W x 24.5"H x 21.75"D	C/LA237/BBO 64.75"W x 21.75"H x 21.25"D	C/MM237/GW/BK 64.75"W x 21.5"H x 21.25"D	C/ML237/WH/BK 64.75"W x 21.5"H x 21.25"D	C/OS237/BG 64.75"W x 21.5"H x 21.25"D	C/SE237/GO 64.75"W x 21.5"H x 21.25"D	C/SO237/AC 64.75"W x 24.5"H x 21.25"D		C/ZU237/OB 64.75"W x 21.5"H x 21.25"D
	C/LA247/BBO 85.5"W x 21.88"H x 21.25"D	C/MM247/GW/BK 85.5"W x 21.5"H x 21.25"D	C/ML247/WH/BK 85.5"W x 21.5"H x 21.25"D	C/OS247/BG 85.5"W x 21.5"H x 21.25"D	C/SE247/GO 85.5"W x 21.5"H x 21.25"D	C/SO247/AC 85.5"W x 24.5"H x 21.25"D		C/ZU247/OB 85.5"W x 21.5"H x 21.25"D
	C/LA337/BBO 64.75"W x 31.75"H x 21.25"D	C/MM337/GW/BK 64.75"W x 31.375"H x 21.25"D	C/ML337/WH/BK 64.75"W x 31.375"H x 21.25"D	C/OS337/BG 64.75"W x 31.375"H x 21.25"D	C/SE337/GO 64.75"W x 31.375"H x 21.25"D	C/SO337/AC 64.75"W x 33.75"H x 21.25"D		C/ZU337/OB 64.75"W x 31.375"H x 21.25"D
	C/LA347/BBO 85.5"W x 31.75"H x 21.25"D	C/MM347/GW/BK 85.5"W x 31.375"H x 21.25"D	C/ML347/WH/BK 85.5"W x 31.375"H x 21.25"D	C/OS347/BG 85.5"W x 31.375"H x 21.25"D	C/SE347/GO 85.5"W x 31.375"H x 21.25"D	C/SO347/AC 85.5"W x 33.75"H x 21.25"D		C/ZU347/OB 85.5"W x 31.375"H x 21.25"D



**BARCELONA
WHITE**



**BARCELONA
BLACK GLASS**



BERLIN



CHICAGO



CORSICA



**DENVER
NATURAL OAK**



**DENVER
NATURAL WALNUT**



ELBA

SPEAKER INTEGRATED AV CABINETS - See interior dimensions on page 17.

217 Subwoofer Enclosure	C/BA217SE/NW/GW 24.25"W x 24.25"H x 21.25"D	C/BA217SE/NW/BG 24.25"W x 24.25"H x 21.25"D	C/BL217SE/WE 23.25"W x 21.5"H x 21.25"D	C/CH217SE/BO 23.25"W x 21.5"H x 21.25"D	C/CO217SE/AC 25.75"W x 22.5"H x 21.25"D	C/DV217SE/NO 23.25"W x 21.5"H x 21.25"D	C/DV217SE/MW 23.25"W x 21.5"H x 21.25"D	C/EL217SE/AC 23.25"W x 24.5"H x 21.25"D
236 AV Cabinet	C/BA236/NW/GW 65.75"W x 24.25"H x 21.25"D	C/BA236/NW/BG 65.75"W x 24.25"H x 21.25"D	C/BL236/WE 64.75"W x 21.5"H x 21.25"D	C/CH236/BO 64.75"W x 21.5"H x 21.25"D	C/CO236/AC 67.25"W x 22.5"H x 21.25"D	C/DV236/NO 64.75"W x 21.5"H x 21.25"D	C/DV236/MW 64.75"W x 21.5"H x 21.25"D	C/EL236/AC 64.75"W x 24.5"H x 21.25"D
245 AV Cabinet	C/BA245/NW/GW 86.5"W x 24.25"H x 21.25"D	C/BA245/NW/BG 86.5"W x 24.25"H x 21.25"D	C/BL245/WE 85.5"W x 21.5"H x 21.25"D	C/CH245/BO 85.5"W x 21.5"H x 21.25"D	C/CO245/AC 88"W x 22.5"H x 21.25"D	C/DV245/NO 85.5"W x 21.5"H x 21.25"D	C/DV245/MW 85.5"W x 21.5"H x 21.25"D	C/EL245/AC 85.5"W x 24.5"H x 21.25"D
329 AV Cabinet	C/BA329/NW/GW 45"W x 34.5"H x 21.25"D	C/BA329/NW/BG 45"W x 34.5"H x 21.25"D	C/BL329/WE 44"W x 31.25"H x 21.25"D	C/CH329/BO 44"W x 31.25"H x 21.25"D	C/CO329/AC 46.5"W x 32"H x 21.25"D	C/DV329/NO 44"W x 31.25"H x 21.25"D	C/DV329/MW 44"W x 31.25"H x 21.25"D	C/EL329/AC 44"W x 33.75"H x 21.25"D
336 AV Cabinet	C/BA336/NW/GW 65.75"W x 34.5"H x 21.25"D	C/BA336/NW/BG 65.75"W x 34.5"H x 21.25"D	C/BL336/WE 64.75"W x 31.25"H x 21.25"D	C/CH336/BO 64.75"W x 31.25"H x 21.25"D	C/CO336/AC 67.25"W x 32"H x 21.25"D	C/DV336/NO 64.75"W x 31.25"H x 21.25"D	C/DV336/MW 64.75"W x 31.25"H x 21.25"D	C/EL336/AC 64.75"W x 33.75"H x 21.25"D
339 AV Cabinet	C/BA339/NW/GW 65.75"W x 34.5"H x 21.25"D	C/BA339/NW/BG 65.75"W x 34.5"H x 21.25"D	C/BL339/WE 64.75"W x 31.25"H x 21.25"D	C/CH339/BO 64.75"W x 31.25"H x 21.25"D	C/CO339/AC 67.25"W x 32"H x 21.25"D	C/DV339/NO 64.75"W x 31.25"H x 21.25"D	C/DV339/MW 64.75"W x 31.25"H x 21.25"D	C/EL339/AC 64.75"W x 33.75"H x 21.25"D
345 AV Cabinet	C/BA345/NW/GW 86.5"W x 34.5"H x 21.25"D	C/BA345/NW/BG 86.5"W x 34.5"H x 21.25"D	C/BL345/WE 85.5"W x 31.25"H x 21.25"D	C/CH345/BO 85.5"W x 31.25"H x 21.25"D	C/CO345/AC 88"W x 32"H x 21.25"D	C/DV345/NO 85.5"W x 31.25"H x 21.25"D	C/DV345/MW 85.5"W x 31.25"H x 21.25"D	C/EL345/AC 85.5"W x 33.75"H x 21.25"D

CORNER & AV CABINETS - See interior dimensions on page 21.

221 Corner AV Cabinet	C/BA221CR/NW/GW 45"W x 24.25"H x 21.25"D	C/BA221CR/NW/BG 45"W x 24.25"H x 21.25"D	C/BL221CR/WE 44"W x 21.5"H x 21.25"D	C/CH221CR/BO 44"W x 21.5"H x 21.25"D	C/CO221CR/AC 46.5"W x 22.5"H x 21.25"D	C/DV221CR/NO 44"W x 21.5"H x 21.25"D	C/DV221CR/MW 44"W x 21.5"H x 21.25"D	C/EL221CR/AC 44"W x 24.5"H x 21.25"D
323 Corner AV Cabinet	C/BA323CR/NW/GW 45"W x 34.5"H x 21.25"D	C/BA323CR/NW/BG 45"W x 34.5"H x 21.25"D	C/BL323CR/WE 44"W x 31.25"H x 21.25"D	C/CH323CR/BO 44"W x 31.25"H x 21.25"D	C/CO323CR/AC 46.5"W x 32"H x 21.25"D	C/DV323CR/NO 44"W x 31.25"H x 21.25"D	C/DV323CR/MW 44"W x 31.25"H x 21.25"D	C/EL323CR/AC 44"W x 33.75"H x 21.25"D
329 Corner AV Cabinet	C/BA329CR/NW/GW 45"W x 34.5"H x 21.25"D	C/BA329CR/NW/BG 45"W x 34.5"H x 21.25"D	C/BL329CR/WE 44"W x 31.25"H x 21.25"D	C/CH329CR/BO 44"W x 31.25"H x 21.25"D	C/CO329CR/AC 46.5"W x 31.25"H x 21.25"D	C/DV329CR/NO 44"W x 31.25"H x 21.25"D	C/DV329CR/MW 44"W x 31.25"H x 21.25"D	C/EL329CR/AC 44"W x 33.75"H x 21.25"D

PRO AUDIO RACK - See interior dimensions on page 20.

317 Pro Audio Rack	C/BA317RM/NW/GW 24.25"W x 34.5"H x 21.25"D	C/BA317RM/NW/BG 24.25"W x 34.5"H x 21.25"D	C/BL317RM/WE 23.25"W x 31.25"H x 21.25"D	C/CH317RM/BO 23.25"W x 31.25"H x 21.25"D	C/CO317RM/AC 25.75"W x 32"H x 21.25"D	C/DV317RM/NO 23.25"W x 31.25"H x 21.25"D	C/DV317RM/MW 23.25"W x 31.25"H x 21.25"D	C/EL317RM/AC 23.25"W x 33.75"H x 21.25"D
323 Pro Audio Rack	C/BA323RM/NW/GW 45"W x 34.5"H x 21.25"D	C/BA323RM/NW/BG 45"W x 34.5"H x 21.25"D	C/BL323RM/WE 44"W x 31.25"H x 21.25"D	C/CH323RM/BO 44"W x 31.25"H x 21.25"D	C/CO323RM/AC 46.5"W x 32"H x 21.25"D	C/DV323RM/NO 44"W x 31.25"H x 21.25"D	C/DV323RM/MW 44"W x 31.25"H x 21.25"D	C/EL323RM/AC 44"W x 33.75"H x 21.25"D
517 Pro Audio Rack	C/BA517RM/NW/GW 24.25"W x 54.5"H x 21.25"D	C/BA517RM/NW/BG 24.25"W x 54.5"H x 21.25"D	C/BL517RM/WE 23.25"W x 50.875"H x 21.25"D	C/CH517RM/BO 23.25"W x 50.875"H x 21.25"D	C/CO517RM/AC 25.75"W x 51.75"H x 21.25"D	C/DV517RM/NO 23.25"W x 50.875"H x 21.25"D	C/DV517RM/MW 23.25"W x 50.875"H x 21.25"D	C/EL517RM/AC 23.25"W x 53.625"H x 21.25"D
617 Pro Audio Rack	C/BA617RM/NW/GW 24.25"W x 64.5"H x 21.25"D	C/BA617RM/NW/BG 24.25"W x 64.5"H x 21.25"D	C/BL617RM/WE 23.25"W x 60.625"H x 21.25"D	C/CH617RM/BO 23.25"W x 60.625"H x 21.25"D	C/CO617RM/AC 25.75"W x 61.25"H x 21.25"D	C/DV617RM/NO 23.25"W x 60.625"H x 21.25"D	C/DV617RM/MW 23.25"W x 60.625"H x 21.25"D	C/EL617RM/AC 23.25"W x 63.25"H x 21.25"D



HAMPTON

LANCASTER

MIAMI

MILAN

OLSO

SEATTLE

SONOMA

VENICE

ZURICH

	C/LA217SE/BBO 23.25"W x 21.75"H x 21.25"D	C/MM217SE/GW/BK 23.25"W x 21.5"H x 21.25"D	C/ML217SE/WH/BK 23.25"W x 21.5"H x 21.25"D	C/OS217SE/BG 23.25"W x 21.5"H x 21.25"D	C/SE217SE/GO 23.25"W x 21.5"H x 21.25"D	C/SO217SE/AC 23.25"W x 24.5"H x 21.25"D		C/ZU217SE/OB 23.25"W x 21.5"H x 21.25"D	
C/HA236/DB 66"W x 24.5"H x 21.25"D	C/LA236/BBO 64.75"W x 21.75"H x 21.25"D	C/MM236/GW/BK 64.75"W x 21.5"H x 21.25"D	C/ML236/WH/BK 64.75"W x 21.5"H x 21.25"D	C/OS236/BG 64.75"W x 21.5"H x 21.25"D	C/SE236/GO 64.75"W x 21.5"H x 21.25"D	C/SO236/AC 64.75"W x 24.5"H x 21.25"D		C/ZU236/OB 64.75"W x 21.5"H x 21.25"D	
	C/LA245/BBO 85.5"W x 21.75"H x 21.25"D	C/MM245/GW/BK 85.5"W x 21.5"H x 21.25"D	C/ML245/WH/BK 85.5"W x 21.5"H x 21.25"D	C/OS245/BG 85.5"W x 21.5"H x 21.25"D	C/SE245/GO 85.5"W x 21.5"H x 21.25"D	C/SO245/AC 85.5"W x 24.5"H x 21.25"D		C/ZU245/OB 85.5"W x 21.5"H x 21.25"D	
	C/LA329/BBO 44"W x 31.75"H x 21.25"D	C/MM329/GW/BK 44"W x 31.25"H x 21.25"D	C/ML329/WH/BK 44"W x 31.25"H x 21.25"D	C/OS329/BG 44"W x 31.25"H x 21.25"D	C/SE329/GO 44"W x 31.25"H x 21.25"D	C/SO329/AC 44"W x 33.75"H x 21.25"D	C/VE329/CA 45.25"W x 33.25"H x 21.75"D	C/ZU329/OB 44"W x 31.25"H x 21.25"D	
	C/LA336/BBO 64.75"W x 31.75"H x 21.25"D	C/MM336/GW/BK 64.75"W x 31.25"H x 21.25"D	C/ML336/WH/BK 64.75"W x 31.25"H x 21.25"D	C/OS336/BG 64.75"W x 31.25"H x 21.25"D	C/SE336/GO 64.75"W x 31.25"H x 21.25"D	C/SO336/AC 64.75"W x 33.75"H x 21.25"D		C/ZU336/OB 64.75"W x 31.25"H x 21.25"D	
	C/LA339/BBO 64.75"W x 31.75"H x 21.25"D	C/MM339/GW/BK 64.75"W x 31.25"H x 21.25"D	C/ML339/WH/BK 64.75"W x 31.25"H x 21.25"D	C/OS339/BG 64.75"W x 31.25"H x 21.25"D	C/SE339/GO 64.75"W x 31.25"H x 21.25"D	C/SO339/AC 64.75"W x 33.75"H x 21.25"D	C/VE339/CA 66"W x 33.25"H x 21.75"D	C/ZU339/OB 64.75"W x 31.25"H x 21.25"D	
	C/LA345/BBO 85.5"W x 31.75"H x 21.25"D	C/MM345/GW/BK 85.5"W x 31.25"H x 21.25"D	C/ML345/WH/BK 85.5"W x 31.25"H x 21.25"D	C/OS345/BG 85.5"W x 31.25"H x 21.25"D	C/SE345/GO 85.5"W x 31.25"H x 21.25"D	C/SO345/AC 85.5"W x 33.75"H x 21.25"D		C/ZU345/OB 85.5"W x 31.25"H x 21.25"D	
	C/HA221CR/DB 45.25"W x 24.5"H x 21.25"D	C/LA221CR/BBO 44"W x 21.75"H x 21.25"D	C/MM221CR/GW/BK 44"W x 21.5"H x 21.25"D	C/ML221CR/WH/BK 44"W x 21.5"H x 21.25"D	C/OS221CR/BG 44"W x 21.5"H x 21.25"D	C/SE221CR/GO 44"W x 21.5"H x 21.25"D	C/SO221CR/AC 44"W x 24.5"H x 21.25"D	C/VE221CR/CA 45.25"W x 24"H x 21.75"D	C/ZU221CR/OB 44"W x 21.5"H x 21.25"D
	C/LA323CR/BBO 44"W x 31.75"H x 21.25"D	C/MM323CR/GW/BK 44"W x 31.25"H x 21.25"D	C/ML323CR/WH/BK 44"W x 31.25"H x 21.25"D	C/OS323CR/BG 44"W x 31.25"H x 21.25"D	C/SE323CR/GO 44"W x 31.25"H x 21.25"D	C/SO323CR/AC 44"W x 33.75"H x 21.25"D	C/VE323CR/CA 45.25"W x 33.25"H x 21.75"D	C/ZU323CR/OB 44"W x 31.25"H x 21.25"D	
	C/LA329CR/BBO 44"W x 31.75"H x 21.25"D	C/MM329CR/GW/BK 44"W x 31.25"H x 21.25"D	C/ML329CR/WH/BK 44"W x 31.25"H x 21.25"D	C/OS329CR/BG 44"W x 31.25"H x 21.25"D	C/SE329CR/GO 44"W x 31.25"H x 21.25"D	C/SO329CR/AC 44"W x 33.75"H x 21.25"D	C/VE329CR/CA 45.25"W x 33.25"H x 21.75"D	C/ZU329CR/OB 44"W x 31.25"H x 21.25"D	
	C/LA317RM/BBO 23.25"W x 31.75"H x 21.25"D	C/MM317RM/GW/BK 23.25"W x 31.25"H x 21.25"D	C/ML317RM/WH/BK 23.25"W x 31.25"H x 21.25"D	C/OS317RM/BG 23.25"W x 31.25"H x 21.25"D	C/SE317RM/GO 23.25"W x 31.25"H x 21.25"D	C/SO317RM/AC 23.25"W x 33.75"H x 21.25"D		C/ZU317RM/OB 23.25"W x 31.25"H x 21.25"D	
	C/LA323RM/BBO 44"W x 31.75"H x 21.25"D	C/MM323RM/GW/BK 44"W x 31.25"H x 21.25"D	C/ML323RM/WH/BK 44"W x 31.25"H x 21.25"D	C/OS323RM/BG 44"W x 31.25"H x 21.25"D	C/SE323RM/GO 44"W x 31.25"H x 21.25"D	C/SO323RM/AC 44"W x 33.75"H x 21.25"D	C/VE323RM/CA 45.25"W x 33.25"H x 21.75"D	C/ZU323RM/OB 44"W x 31.25"H x 21.25"D	
	C/LA517RM/BBO 23.25"W x 51.25"H x 21.25"D	C/MM517RM/GW/BK 23.25"W x 50.875"H x 21.25"D	C/ML517RM/WH/BK 23.25"W x 50.875"H x 21.25"D	C/OS517RM/BG 23.25"W x 50.875"H x 21.25"D	C/SE517RM/GO 23.25"W x 50.875"H x 21.25"D	C/SO517RM/AC 23.25"W x 53.625"H x 21.25"D		C/ZU517RM/OB 23.25"W x 50.875"H x 21.25"D	
	C/LA617RM/BBO 23.25"W x 61"H x 21.25"D	C/MM617RM/GW/BK 23.25"W x 60.625"H x 21.25"D	C/ML617RM/WH/BK 23.25"W x 60.625"H x 21.25"D	C/OS617RM/BG 23.25"W x 60.625"H x 21.25"D	C/SE617RM/GO 23.25"W x 60.625"H x 21.25"D	C/SO617RM/AC 23.25"W x 63.25"H x 21.25"D		C/ZU617RM/OB 23.25"W x 60.625"H x 21.25"D	



**BARCELONA
WHITE**



**BARCELONA
BLACK GLASS**



BERLIN



CHICAGO



CORSICA



**DENVER
NATURAL OAK**



**DENVER
NATURAL WALNUT**



ELBA

PROJECTOR CABINETS

Epson LS100			X/EPS237BL/WE 64.75"W x 22.79"H x 21.28"D	X/EPS237CH/BO 64.75"W x 22.79"H x 21.28"D		X/EPS237DV/NO 64.75"W x 22.79"H x 21.28"D	X/EPS237DV/MW 64.75"W x 22.79"H x 21.28"D	
Vivitek DH765Z-UST, DW763Z-UST, DH768Z-UST			X/VIV237BL/WE 64.75"W x 21.5"H x 21.28"D	X/VIV237CH/BO 64.75"W x 21.5"H x 21.28"D		X/VIV237DV/NO 64.75"W x 21.5"H x 21.28"D	X/VIV237DV/MW 64.75"W x 21.5"H x 21.28"D	

SPEAKER INTEGRATED PROJECTOR CABINETS

Epson LS100			X/EPS236BL/WE 64.75"W x 22.79"H x 21.28"D	X/EPS236CH/BO 64.75"W x 22.79"H x 21.28"D		X/EPS236DV/NO 64.75"W x 22.79"H x 21.28"D	X/EPS236DV/MW 64.75"W x 22.79"H x 21.28"D	
Hisense 100L8E			X/HSE245BL/WE 85.5"W x 21.28"H x 21.28"D	X/HSE245CH/BO 85.5"W x 21.28"H x 21.28"D		X/HSE245DV/NO 85.5"W x 21.28"H x 21.28"D	X/HSE245DV/MW 85.5"W x 21.28"H x 21.28"D	
Hisense 100L10E, 120L10E, 150L10E			X/HSE10/245BL/WE 85.5"W x 21.28"H x 21.28"D	X/HSE10/245CH/BO 85.5"W x 21.28"H x 21.28"D		X/HSE10/245DV/NO 85.5"W x 21.28"H x 21.28"D	X/HSE10/245DV/MW 85.5"W x 21.28"H x 21.28"D	
Sony VPLVZ1000ES				X/SNY245CH/BO 85.5"W x 21.5"H x 21.28"D				
Vivitek DH765Z-UST, DW763Z-UST, DH768Z-UST			X/VIV236BL/WE 64.75"W x 21.5"H x 21.28"D	X/VIV236CH/BO 64.75"W x 21.5"H x 21.28"D		X/VIV236DV/NO 64.75"W x 21.5"H x 21.28"D	X/VIV236DV/MW 64.75"W x 21.5"H x 21.28"D	



HAMPTON

LANCASTER

MIAMI

MILAN

OLSO

SEATTLE

SONOMA

VENICE

ZURICH

		X/EPS237MM/GW/BK 64.75"W x 22.79"H x 21.28"D	X/EPS237ML/BK 64.75"W x 22.79"H x 21.28"D	X/EPS237OS/BG 64.75"W x 22.79"H x 21.28"D	X/EPS237SE/GO 64.75"W x 22.79"H x 21.28"D			X/EPS237ZU/OB 64.75"W x 22.79"H x 21.28"D
		X/VIV237MM/GW/BK 64.75"W x 21.5"H x 21.28"D	X/VIV237ML/BK 64.75"W x 21.5"H x 21.28"D	X/VIV237OS/BG 64.75"W x 21.5"H x 21.28"D	X/VIV237SE/GO 64.75"W x 21.5"H x 21.28"D			X/VIV237ZU/OB 44"W x 31.25"H x 21.25"D
		X/EPS236MM/GW/BK 64.75"W x 22.79"H x 21.28"D	X/EPS236ML/BK 64.75"W x 22.79"H x 21.28"D	X/EPS236OS/BG 64.75"W x 22.79"H x 21.28"D	X/EPS236SE/GO 64.75"W x 22.79"H x 21.28"D			X/EPS236ZU/OB 64.75"W x 22.79"H x 21.28"D
		X/HSE245MM/GW/BK 85.5"W x 21.28"H x 21.28"D	X/HSE245ML/BK 85.5"W x 21.28"H x 21.28"D	X/HSE245OS/BG 85.5"W x 21.28"H x 21.28"D	X/HSE245SE/GO 85.5"W x 21.28"H x 21.28"D			X/HSE245ZU/OB 85.5"W x 21.28"H x 21.28"D
		X/HSE10/245MM/GW/BK 85.5"W x 21.28"H x 21.28"D	X/HSE10/245ML/BK 85.5"W x 21.28"H x 21.28"D	X/HSE10/245OS/BG 85.5"W x 21.28"H x 21.28"D	X/HSE10/245SE/GO 85.5"W x 21.28"H x 21.28"D			X/HSE10/245ZU/OB 85.5"W x 21.28"H x 21.28"D
		X/SNY245MM/GW/BK/BK 85.5"W x 21.5"H x 21.28"D		X/SNY245OS/BG 85.5"W x 21.5"H x 21.28"D	X/SNY245SE/GO/BK 85.5"W x 21.5"H x 21.28"D			
		X/VIV236MM/GW/BK 64.75"W x 21.5"H x 21.28"D	X/VIV236ML/BK 64.75"W x 21.5"H x 21.28"D	X/VIV236OS/BG 64.75"W x 21.5"H x 21.28"D	X/SNY245SE/GO/BK 85.5"W x 21.5"H x 21.28"D			X/VIV236ZU/OB 64.75"W x 21.5"H x 21.28"D

built on



Triple-Width 237

BARCELONA

NATURAL WALNUT, WHITE

Clean, cutting-edge design with bevelled edges and precision miter joints.



BARCELONA

NATURAL WALNUT / WHITE

See Models & Dimensions on pages 26-31

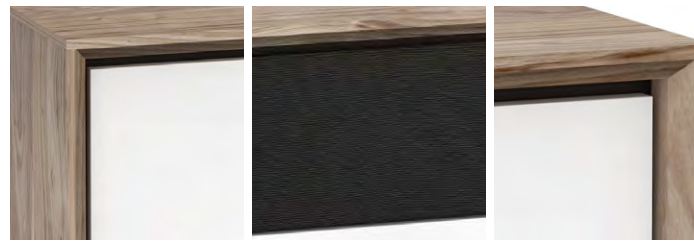

Gloss White Doors

Brown Speaker Grill
(Models 329, 236, 336 & 339)

Mitered Edges



217
Audio Cabinet
Subwoofer Enclosure



317
Audio Cabinet
Pro Audio Rack



517
Audio Cabinet
Pro Audio Rack



617
Audio Cabinet
Pro Audio Rack



221
AV Cabinet
Corner Cabinet



323
AV Cabinet
Pro Audio Rack
Corner Cabinet



329 - Speaker Integration
AV Cabinet
Corner Cabinet



236 - Speaker Integration
AV Cabinet



237
AV Cabinet



337
AV Cabinet



336 - Speaker Integration
AV Cabinet



339 - Speaker Integration
AV Cabinet



247
AV Cabinet



347
AV Cabinet



245 - Speaker Integration
AV Cabinet



345 - Speaker Integration
AV Cabinet

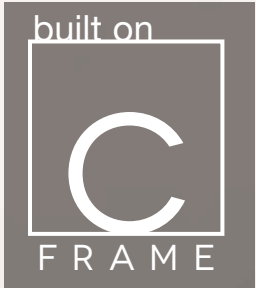

BARCELONA

NATURAL WALNUT, BLACK GLASS

Clean, cutting-edge design with bevelled edges and precision miter joints.





BARCELONA

NATURAL WALNUT / BLACK GLASS

See Models & Dimensions on pages 26-31

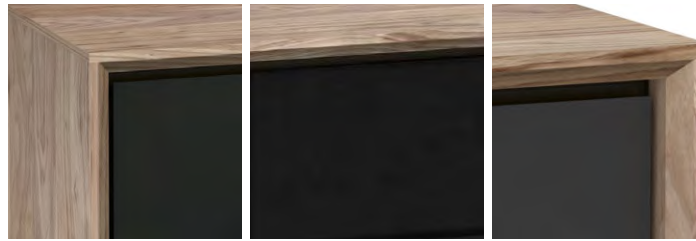

Black Glass Doors

Black Speaker Grill
(Models 329, 236, 336 & 339)

Mitered Edges



217
Audio Cabinet
Subwoofer Enclosure



317
Audio Cabinet
Pro Audio Rack



517
Audio Cabinet
Pro Audio Rack



617
Audio Cabinet
Pro Audio Rack



221
AV Cabinet
Corner Cabinet



323
AV Cabinet
Pro Audio Rack
Corner Cabinet



329 - Speaker Integration
AV Cabinet
Corner Cabinet



236 - Speaker Integration
AV Cabinet



237
AV Cabinet



337
AV Cabinet



336 - Speaker Integration
AV Cabinet



339 - Speaker Integration
AV Cabinet



247
AV Cabinet



347
AV Cabinet



245 - Speaker Integration
AV Cabinet



345 - Speaker Integration
AV Cabinet

Quad-Width 247 On-Wall
(Wall Kit Sold Separately)



BERLIN

WENGÉ, WAVE TEXTURE, BLACK GLASS

A distinctly European influence with its wave textured front.



***MULTIPLE TOP
OPTIONS AVAILABLE
CALL FOR DETAILS**

*Black Glass top
comes standard*

Custom fee will apply





236 - Projector and Speaker Integration
Epson and Vivitek models



237 - Projector Integration
Vivitek and Epson models



245 - Projector Integration
Hisense



217
Audio Cabinet
Subwoofer Enclosure



317
Audio Cabinet
Pro Audio Rack



517
Audio Cabinet
Pro Audio Rack



617
Audio Cabinet
Pro Audio Rack



221
AV Cabinet (Wall Mountable)
Corner Cabinet



323
AV Cabinet
Pro Audio Rack
Corner Cabinet



329 - Speaker Integration
AV Cabinet
Corner Cabinet



236 - Speaker Integration
AV Cabinet (Wall Mountable)



237
AV Cabinet (Wall Mountable)



337
AV Cabinet
Low Profile Cabinet



336 - Speaker Integration
AV Cabinet



339 - Speaker Integration
AV Cabinet



247
AV Cabinet (Wall Mountable)



347
AV Cabinet
Low Profile Cabinet



245 - Speaker Integration
AV Cabinet (Wall Mountable)



345 - Speaker Integration
AV Cabinet
Low Profile Cabinet

Quad-Width 245 On-Wall
(Wall Kit Sold Separately)



CHICAGO

BLACK OAK, GRASS TEXTURE, GLASS TOP

Black Oak finish with Tall Grass Texture & Black Glass top.



***MULTIPLE TOP
OPTIONS AVAILABLE
CALL FOR DETAILS**

*Black Glass top
comes standard*

Custom fee will apply





236 - Projector and Speaker Integration
Epson and Vivitek models



237 - Projector Integration
Vivitek and Epson models



245 - Projector and Speaker Integration
Sony and Hisense models



217
Audio Cabinet
Subwoofer Enclosure



317
Audio Cabinet
Pro Audio Rack



517
Audio Cabinet
Pro Audio Rack



617
Audio Cabinet
Pro Audio Rack



221
AV Cabinet (Wall Mountable)
Corner Cabinet



323
AV Cabinet
Pro Audio Rack
Corner Cabinet



329 - Speaker Integration
AV Cabinet
Corner Cabinet



236 - Speaker Integration
AV Cabinet (Wall Mountable)



237
AV Cabinet (Wall Mountable)



337
AV Cabinet
Low Profile Cabinet



336 - Speaker Integration
AV Cabinet



339 - Speaker Integration
AV Cabinet



247
AV Cabinet (Wall Mountable)



347
AV Cabinet
Low Profile Cabinet



245 - Speaker Integration
AV Cabinet (Wall Mountable)



345 - Speaker Integration
AV Cabinet
Low Profile Cabinet

built on
C
FRAME



CORSICA

AMERICAN CHERRY, BLACK GLASS

This easy going and laid back style is represented in a cherry finish, with extra-thick end panels.

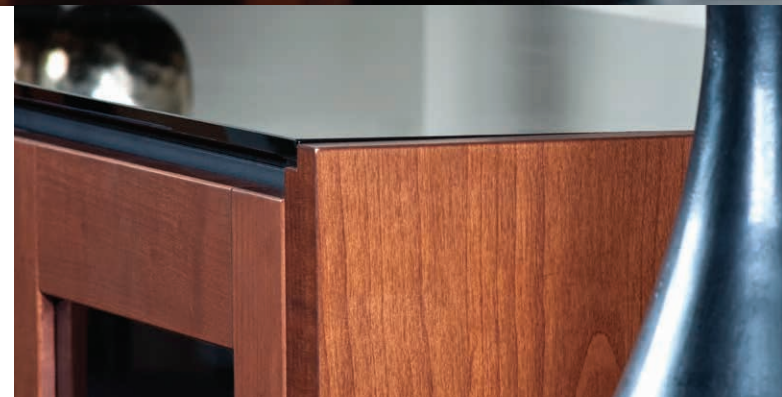



CORSICA

AMERICAN CHERRY, BLACK GLASS



American Cherry Finish,
Solid Wood Framed Smoked Glass
Door With Hidden Finger Pull



Black Speaker Grill
(Models 329, 236, 336 & 339)



Black Tempered Glass Top

See Models & Dimensions on pages 26-31



217
Audio Cabinet
Subwoofer Enclosure



317
Audio Cabinet
Pro Audio Rack



517
Audio Cabinet
Pro Audio Rack



617
Audio Cabinet
Pro Audio Rack



221
AV Cabinet
Corner Cabinet



323
AV Cabinet
Pro Audio Rack
Corner Cabinet



329 - Speaker Integration
AV Cabinet
Corner Cabinet



236 - Speaker Integration
AV Cabinet



237
AV Cabinet



337
AV Cabinet



336 - Speaker Integration
AV Cabinet



339 - Speaker Integration
AV Cabinet



247
AV Cabinet



347
AV Cabinet



245 - Speaker Integration
AV Cabinet



345 - Speaker Integration
AV Cabinet

built on



Triple-Width 236 On-Wall
(Wall Kit Sold Separately)



DENVER

MEDIUM WALNUT, BARK TEXTURE, GLASS TOP

Deeply embossed, horizontal grains- akin to wheat stalks, offer a rustic look.



***MULTIPLE TOP
OPTIONS AVAILABLE
CALL FOR DETAILS**

*Black Glass top
comes standard*

Custom fee will apply

Solid Surface - Black

*Glass - Black





DENVER

MEDIUM WALNUT,
BARK TEXTURE

See Models & Dimensions on pages 26-31



236 - Projector and Speaker Integration
Epson and Vivitek models



237 - Projector Integration
Vivitek and Epson models



245 - Projector and Speaker Integration
Hisense



217
Audio Cabinet
Subwoofer Enclosure



317
Audio Cabinet
Pro Audio Rack



517
Audio Cabinet
Pro Audio Rack



617
Audio Cabinet
Pro Audio Rack



221
AV Cabinet (Wall Mountable)
Corner Cabinet



323
AV Cabinet
Pro Audio Rack
Corner Cabinet



329 - Speaker Integration
AV Cabinet
Corner Cabinet



236 - Speaker Integration
AV Cabinet (Wall Mountable)



237
AV Cabinet (Wall Mountable)



337
AV Cabinet
Low Profile Cabinet



336 - Speaker Integration
AV Cabinet



339 - Speaker Integration
AV Cabinet



247
AV Cabinet (Wall Mountable)



347
AV Cabinet
Low Profile Cabinet



245 - Speaker Integration
AV Cabinet (Wall Mountable)



345 - Speaker Integration
AV Cabinet
Low Profile Cabinet

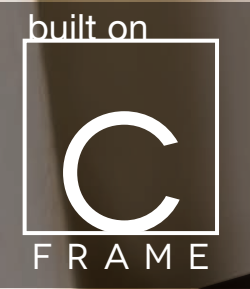

DENVER

NATURAL WALNUT, GLASS TOP

Deeply embossed, horizontal grains- akin to bark, offer a rustic look.



***MULTIPLE TOP
OPTIONS AVAILABLE
CALL FOR DETAILS**

*Black Glass top
comes standard*

Custom fee will apply





DENVER

NATURAL OAK, BARK TEXTURE

See Models & Dimensions on pages 26-31



236 - Projector and Speaker Integration
Epson and Vivitek models



237 - Projector Integration
Vivitek and Epson models



245 - Projector and Speaker Integration
Hisense



217
Audio Cabinet
Subwoofer Enclosure



317
Audio Cabinet
Pro Audio Rack



517
Audio Cabinet
Pro Audio Rack



617
Audio Cabinet
Pro Audio Rack



221
AV Cabinet (Wall Mountable)
Corner Cabinet



323
AV Cabinet
Pro Audio Rack
Corner Cabinet



329 - Speaker Integration
AV Cabinet
Corner Cabinet



236 - Speaker Integration
AV Cabinet (Wall Mountable)



237
AV Cabinet (Wall Mountable)



337
AV Cabinet
Low Profile Cabinet



336 - Speaker Integration
AV Cabinet



339 - Speaker Integration
AV Cabinet



247
AV Cabinet (Wall Mountable)



347
AV Cabinet
Low Profile Cabinet



245 - Speaker Integration
AV Cabinet (Wall Mountable)



345 - Speaker Integration
AV Cabinet
Low Profile Cabinet

built on



Quad-Width 247 On-Wall
(Wall Kit Sold Separately)

ELBA

AMERICAN CHERRY

Its essence is casual made unique by wide framed wood doors with smoked glass inserts.





Solid Wood Framed
Smoke Glass Doors

Brown Speaker Grill
(Models 329, 236, 336 & 339)

Black Tapered Solid Wood Feet
with Hidden Adjustable Leveler



217
Audio Cabinet
Subwoofer Enclosure



317
Audio Cabinet
Pro Audio Rack



517
Audio Cabinet
Pro Audio Rack



617
Audio Cabinet
Pro Audio Rack



221
AV Cabinet (Wall Mountable)
Corner Cabinet



323
AV Cabinet
Pro Audio Rack
Corner Cabinet



329 - Speaker Integration
AV Cabinet
Corner Cabinet



236 - Speaker Integration
AV Cabinet (Wall Mountable)



237
AV Cabinet (Wall Mountable)



337
AV Cabinet



336 - Speaker Integration
AV Cabinet



339 - Speaker Integration
AV Cabinet



247
AV Cabinet (Wall Mountable)



347
AV Cabinet



245 - Speaker Integration
AV Cabinet (Wall Mountable)



345 - Speaker Integration
AV Cabinet

built on



Twin-Width 221



HAMPTON

DISTRESSED BLACK

This finely crafted unit in distressed black finish is a charming and comfortable design that brings to mind a traditional English country home.





Distressed Black Finish, Raised Panel With Wood Knob



Black Speaker Grill
(Models 236)



Black, Tapered Solid Wood Feet With Hidden Levelers



221
AV Cabinet
Corner Cabinet



237
AV Cabinet



236 - Speaker Integration
AV Cabinet

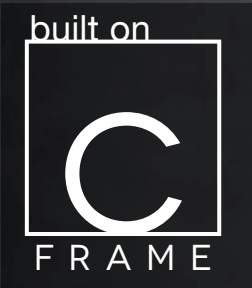

LANCASTER

ROUGH-SAWN BARN BOARD TEXTURE

A rustic, country atmosphere, Lancaster resembles rough-sawn barn board with a comfortable, yet stylish aged appearance.



LANCASTER

ROUGH-SAWN BARN BOARD TEXTURE

See Models & Dimensions on pages 26-31



Deep textured, barn board doors, top and end panels



Espresso, low-profile wood feet with hidden levelers



217
Audio Cabinet
Subwoofer Enclosure



317
Audio Cabinet
Pro Audio Rack



517
Audio Cabinet
Pro Audio Rack



617
Audio Cabinet
Pro Audio Rack



221
AV Cabinet (Wall Mountable)
Corner Cabinet



323
AV Cabinet
Pro Audio Rack
Corner Cabinet



329 - Speaker Integration
AV Cabinet
Corner Cabinet



236 - Speaker Integration
AV Cabinet (Wall Mountable)



237
AV Cabinet (Wall Mountable)



337
AV Cabinet
Low Profile Cabinet



336 - Speaker Integration
AV Cabinet



339 - Speaker Integration
AV Cabinet



247
AV Cabinet (Wall Mountable)



347
AV Cabinet
Low Profile Cabinet



245 - Speaker Integration
AV Cabinet (Wall Mountable)



345 - Speaker Integration
AV Cabinet
Low Profile Cabinet

Quad-Width 247 On-Wall
(Wall Kit Sold Separately)



MIAMI

WARM GLOSS WHITE

High-gloss, warm white side panels and doors beautifully offset the black glass top.



***MULTIPLE TOP
OPTIONS AVAILABLE
CALL FOR DETAILS**

*Black Glass top
comes standard*

Custom fee will apply





236 - Projector and Speaker Integration
Epson and Vivitek models



237 - Projector Integration
Vivitek and Epson models



245 - Projector and Speaker Integration
Sony and Hisense models



217
Audio Cabinet
Subwoofer Enclosure



317
Audio Cabinet
Pro Audio Rack



517
Audio Cabinet
Pro Audio Rack



617
Audio Cabinet
Pro Audio Rack



221
AV Cabinet (Wall Mountable)
Corner Cabinet



323
AV Cabinet
Pro Audio Rack
Corner Cabinet



329 - Speaker Integration
AV Cabinet
Corner Cabinet



236 - Speaker Integration
AV Cabinet (Wall Mountable)



237
AV Cabinet (Wall Mountable)



337
AV Cabinet
Low Profile Cabinet



336 - Speaker Integration
AV Cabinet



339 - Speaker Integration
AV Cabinet



247
AV Cabinet (Wall Mountable)



347
AV Cabinet
Low Profile Cabinet



245 - Speaker Integration
AV Cabinet (Wall Mountable)



345 - Speaker Integration
AV Cabinet
Low Profile Cabinet

built on



Quad-Width 247
On-Wall
(Wall Kit Sold Separately)



MILAN

3-DIMENSIONAL DIAMOND DOOR PATTERN, GLASS TOP

Finished in white, Milan is a sleek door design with a modern geometric three-dimensional, diamond pattern with black glass top.



***MULTIPLE TOP
OPTIONS AVAILABLE
CALL FOR DETAILS**

*Black Glass top
comes standard*

Custom fee will apply

Solid Surface - Black

Solid Surface - White

Glass - Black



236 - Projector and Speaker Integration
Epson and Vivitek models



237 - Projector Integration
Vivitek and Epson models



245 - Projector and Speaker Integration
Hisense



217
Audio Cabinet
Subwoofer Enclosure



317
Audio Cabinet
Pro Audio Rack



517
Audio Cabinet
Pro Audio Rack



617
Audio Cabinet
Pro Audio Rack



221
AV Cabinet (Wall Mountable)
Corner Cabinet



323
AV Cabinet
Pro Audio Rack
Corner Cabinet



329 - Speaker Integration
AV Cabinet
Corner Cabinet



236 - Speaker Integration
AV Cabinet (Wall Mountable)



237
AV Cabinet (Wall Mountable)



337
AV Cabinet
Low Profile Cabinet



336 - Speaker Integration
AV Cabinet



339 - Speaker Integration
AV Cabinet



247
AV Cabinet (Wall Mountable)



347
AV Cabinet
Low Profile Cabinet



245 - Speaker Integration
AV Cabinet (Wall Mountable)



345 - Speaker Integration
AV Cabinet
Low Profile Cabinet



OSLO

BLACK GLASS, BLACK OAK

Black beauty's ultra-sleek techno aesthetic with smoked glass doors and black glass top.



***MULTIPLE TOP
OPTIONS AVAILABLE
CALL FOR DETAILS**

*Black Glass top
comes standard*

Custom fee will apply



Solid Surface - Black

*Glass - Black



236 - Projector and Speaker Integration
Epson and Vivitek models



237 - Projector Integration
Vivitek and Epson models



245 - Projector and Speaker Integration
Sony and Hisense models



217
Audio Cabinet
Subwoofer Enclosure



317
Audio Cabinet
Pro Audio Rack



517
Audio Cabinet
Pro Audio Rack



617
Audio Cabinet
Pro Audio Rack



221
AV Cabinet (Wall Mountable)
Corner Cabinet



323
AV Cabinet
Pro Audio Rack
Corner Cabinet



329 - Speaker Integration
AV Cabinet
Corner Cabinet



236 - Speaker Integration
AV Cabinet (Wall Mountable)



237
AV Cabinet (Wall Mountable)



337
AV Cabinet
Low Profile Cabinet



336 - Speaker Integration
AV Cabinet



339 - Speaker Integration
AV Cabinet



247
AV Cabinet (Wall Mountable)



347
AV Cabinet
Low Profile Cabinet



245 - Speaker Integration
AV Cabinet (Wall Mountable)



345 - Speaker Integration
AV Cabinet
Low Profile Cabinet



Triple-Width 237

SEATTLE

ALPI GRAY OAK, GRASS TEXTURE, GLAS TOP

The light look and feel of tall grasses is finely set in a vertical textured pattern. Alpi gray oak with black glass top and black feet work in unison, creating the cabinet's hi-tech facade.



***MULTIPLE TOP
OPTIONS AVAILABLE
CALL FOR DETAILS**

*Black Glass top
comes standard*

Custom fee will apply



Solid Surface - Black

*Glass - Black



SEATTLE

ALPI GRAY OAK, GRASS
TEXTURE, BLACK GLASS

See Models & Dimensions on pages 26-31



236 - Projector and Speaker Integration
Epson and Vivitek models



237 - Projector Integration
Vivitek and Epson models



245 - Projector and Speaker Integration
Hisense and Sony models



217
Audio Cabinet
Subwoofer Enclosure



317
Audio Cabinet
Pro Audio Rack



517
Audio Cabinet
Pro Audio Rack



617
Audio Cabinet
Pro Audio Rack



221
AV Cabinet (Wall Mountable)
Corner Cabinet



323
AV Cabinet
Pro Audio Rack
Corner Cabinet



329 - Speaker Integration
AV Cabinet
Corner Cabinet



236 - Speaker Integration
AV Cabinet (Wall Mountable)



237
AV Cabinet (Wall Mountable)



337
AV Cabinet
Low Profile Cabinet



336 - Speaker Integration
AV Cabinet



339 - Speaker Integration
AV Cabinet



247
AV Cabinet (Wall Mountable)



347
AV Cabinet
Low Profile Cabinet



245 - Speaker Integration
AV Cabinet (Wall Mountable)



345 - Speaker Integration
AV Cabinet
Low Profile Cabinet

built on



Triple-Width 339 and
Single-Width 217



SONOMA

AMERICAN CHERRY

This elegantly crafted design is rendered in American cherry and includes vertical slatted doors with black micro-perforated steel inserts for an updated Mission Style.





American Cherry Finish, Solid Wood Framed Panel With Mullions And Micro-Perforated Steel Inserts With Black Pulls

Brown Speaker Grill
(Models 329, 236, 336 & 339)

Black, Tapered Solid Wood Feet With Hidden Levelers



217
Audio Cabinet
Subwoofer Enclosure



317
Audio Cabinet
Pro Audio Rack



517
Audio Cabinet
Pro Audio Rack



617
Audio Cabinet
Pro Audio Rack



221
AV Cabinet (Wall Mountable)
Corner Cabinet



323
AV Cabinet
Pro Audio Rack
Corner Cabinet



329 - Speaker Integration
AV Cabinet
Corner Cabinet



236 - Speaker Integration
AV Cabinet (Wall Mountable)



237
AV Cabinet (Wall Mountable)



337
AV Cabinet



336 - Speaker Integration
AV Cabinet



339 - Speaker Integration
AV Cabinet



247
AV Cabinet (Wall Mountable)



347
AV Cabinet



245 - Speaker Integration
AV Cabinet (Wall Mountable)



345 - Speaker Integration
AV Cabinet



VENICE

ANTIQUÉ CHERRY

The romance of a Tuscan villa is the inspiration for this cabinet with antique cherry glazed finish and brass hardware for a classic antique look.



Antique Cherry Finish, Miter Frame And Panel Doors With Aged Brass Knobs



Brown Speaker Grill
Model 329



Cherry, Tapered Solid Wood Feet With Hidden Levelers



221
AV Cabinet
Corner Cabinet



323
AV Cabinet
Pro Audio Rack
Corner Cabinet



329 - Speaker Integration
AV Cabinet
Corner Cabinet

built on



ZURICH

LINEAR TEXTURE, OPIUM BROWN

This sleek, streamlined design features a horizontal pattern on opium brown wood with a black glass or solid surface top and wood block feet



***MULTIPLE TOP
OPTIONS AVAILABLE
CALL FOR DETAILS**

*Black Glass top
comes standard*

Custom fee will apply

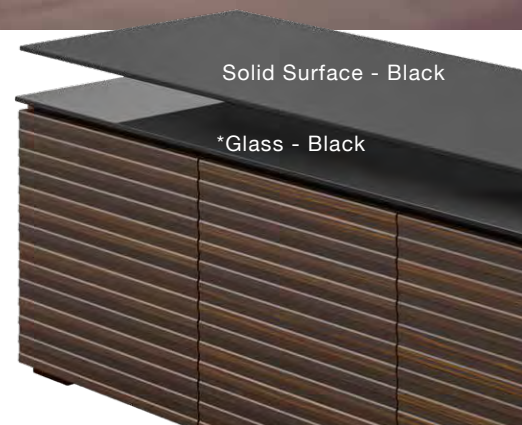

Solid Surface - Black

*Glass - Black



ZURICH

OPIUM BROWN, LINEAR TEXTURE

See Models & Dimensions on pages 26-31



236 - Projector and Speaker Integration
Epson and Vivitek models



237 - Projector Integration
Vivitek and Epson models



245 - Projector and Speaker Integration
Hisense



217
Audio Cabinet
Subwoofer Enclosure



317
Audio Cabinet
Pro Audio Rack



517
Audio Cabinet
Pro Audio Rack



617
Audio Cabinet
Pro Audio Rack



221
AV Cabinet (Wall Mountable)
Corner Cabinet

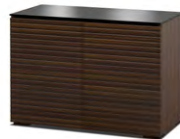

323
AV Cabinet
Pro Audio Rack
Corner Cabinet



329 - Speaker Integration
AV Cabinet
Corner Cabinet



236 - Speaker Integration
AV Cabinet (Wall Mountable)



237
AV Cabinet (Wall Mountable)



337
AV Cabinet
Low Profile Cabinet



336 - Speaker Integration
AV Cabinet

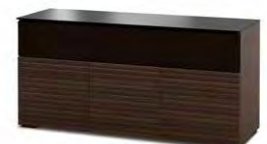

339 - Speaker Integration
AV Cabinet



247
AV Cabinet (Wall Mountable)



347
AV Cabinet
Low Profile Cabinet

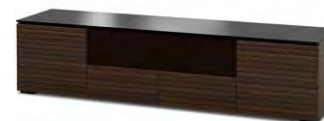

245 - Speaker Integration
AV Cabinet (Wall Mountable)



345 - Speaker Integration
AV Cabinet
Low Profile Cabinet

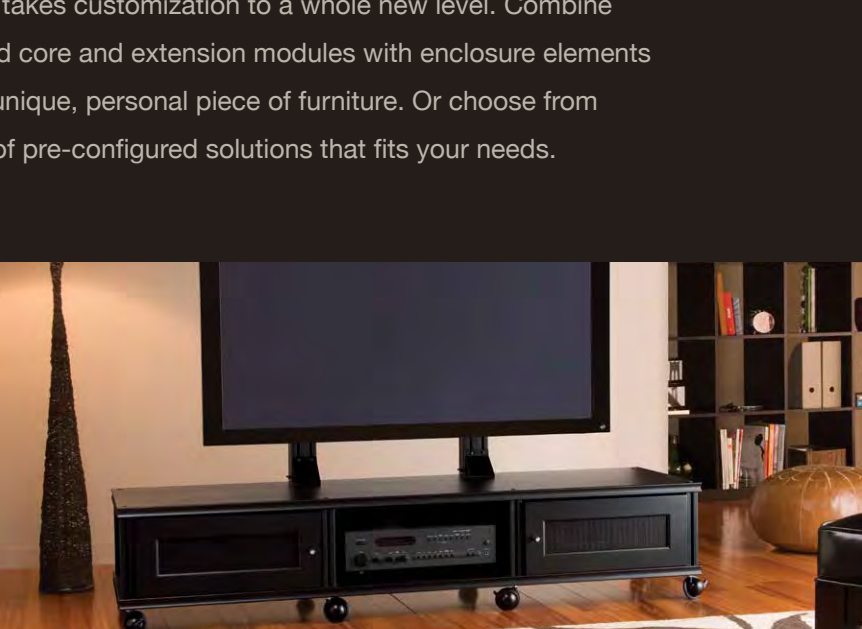
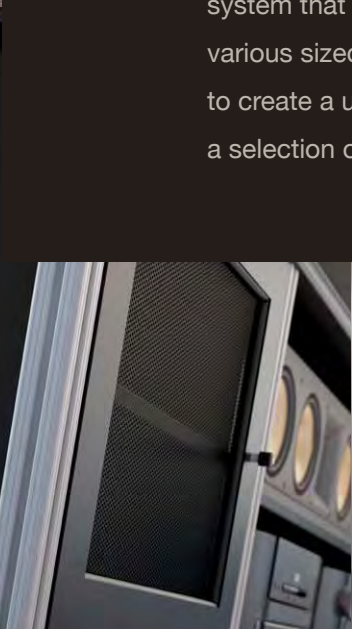
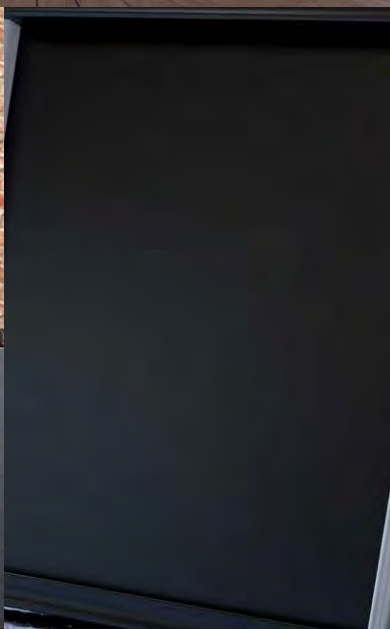

SYNERGY[®]

SYSTEM

Synergy is all about configurability. It is a fully modular furniture system that takes customization to a whole new level. Combine various sized core and extension modules with enclosure elements to create a unique, personal piece of furniture. Or choose from a selection of pre-configured solutions that fits your needs.



SYNERGY SYSTEM MODULAR



Removable Rear Panels
allow easy access to components.



Extension Modules
Straight forward additions that make it easy to extend Synergy cabinets.



Anodized Supports
are the core of the extremely durable modular system.

Core Modules
For use individually or with modules.

Side Panels
Panels slide neatly between support posts enclosing exterior and interior of units.



Snap-on hinges fully extend optional doors and remove easily for better in-cabinet access.



Doors
Enclose any cabinet, fully or partially. Doors can be attached both from the left or right. (Doors sold separately.)

Optional, perforated door permit IR signals, add ventilation and mask speakers.



Drawers
Enclose any cabinet, fully or partially.

VERSATILE

Our award-winning Synergy System™ is a real breakthrough. It is a fully modular furniture system that takes customization to a whole new level. There are so many possibilities, anyone can create a piece of furniture that is uniquely their own.



Synergy Triple-Width 237, Cherry/Black

SYNERGY SYSTEM

DESIGN YOUR OWN

Personalize the appearance of the Synergy System by combining the finest material options. Choose wood finishes, posts, door inserts and side panels. The selection is all up to you.

- 1. Select a Core Module** - Available in Single-Width (23.75"), Twin-Width (44"), Triple-Width (66.25") or Quad-Width (88") in 12", 21", 31" or 41" heights.
- 2. Add Extension Modules** - Available in Single-Width (23.75"), Twin-Width (44"), Triple-Width (66.25") in 9.625", 19", 29", or 39" heights.
- 3. Enclose with Side Panels** - Available in black, wood finishes, black perforated steel.
- 4. Outfit with Doors** - Solid wood framed with black perforated steel inserts.
- 5. Select Wood & Posts** - Solid real wood veneers such as dark cherry, natural maple, dark walnut or black on MDF.

Our unique "Design Your Own" process uses an online Custom "Configurator" tool to help people build their own unique pieces of AV furniture. The Configurator lets anyone select the configuration and functional features that match exactly with their desired use.

www.salamanderdesigns.com

Assembly Available



Natural Maple

Dark Cherry

Dark Walnut

Black

Perforated Steel Door Insert

Silver Post

Black Post



SYNERGY SYSTEM CUSTOM INTERIORS



STORING

Our personal electronics storage is a great all-in-one organizational space storing remotes and other media devices.

MULTI-FUNCTION

Solidly built, these multi-functional pull-out shelves are specifically designed to support turntables and other heavy equipment.

CHARGING

Conveniently charge and store your mobile devices in our pull-out trays. Now there really is a place for everything.

PRO AUDIO

Cabinets can be outfitted with Rack Mounting Rails that allows integration of professional equipment, conforming to EIA 19" rack standards.





SYNERGY SYSTEM ACCESSORIES

An extensive family of accessories allows customization of cabinets to meet specific needs and preferences. Integrated accessories enhance functionality and provide years of reliable service. Feel confident that you can retrofit and upgrade your furniture whenever your needs change.



Integrated TV and Speaker Mounts
combine directly with cabinets



Accent Light sets the mood and adds light just where you need it



Decorator Feet and Wheels fine tune the style and function



Power Conditioning delivers better picture and sound



IR Repeater allows remote controls to operate through solid doors



Active Cooling system protects delicate electronics

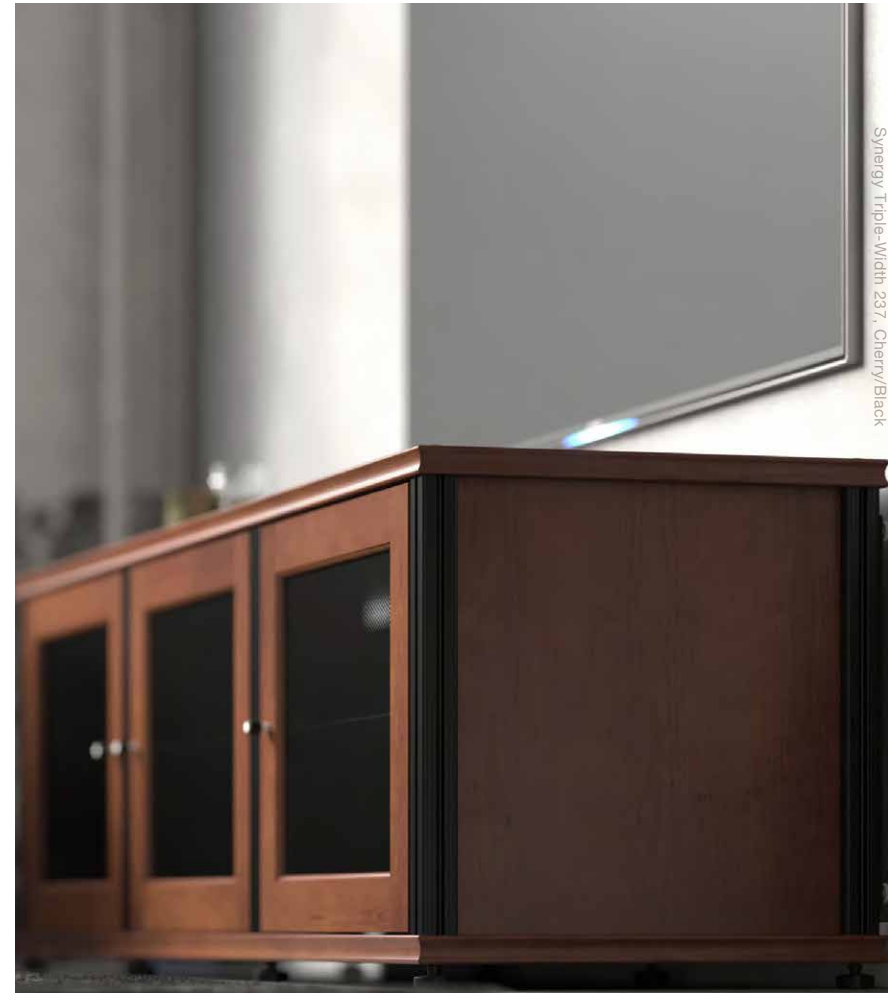

SYNERGY Triple-Width 237, Cherry/Black



Wall Mounting Kits

The wall hanging cabinet is the ultimate way to create the look of custom cabinetry. See Page 103.





SYNERGY SYSTEM SINGLE MODULES

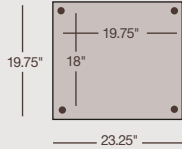

- Open Cabinets can be enclosed with Synergy Doors, Sides and Drawers.
- Infinitely Adjustable, Black Interior Shelves
- Removable Rear Panels provide easy component access.
- Heavy Duty, non-marking leveler feet are standard.
- Capacities:
Top (1.125" thick) holds 150 lbs.
Interior Shelves (3/4" thick) hold 75 lbs each
(Heavy Duty Shelf Brackets hold up to 150 lbs)



Hold TV's
up to 40"



Hold up to
500 lbs

RM Rack Mount Model
Available, See Page 98

W Wall Mountable,
see kit on Page 103

Speaker Integration



Single 20 - Core Module

Black/Black	SU20B/B
Black/Aluminum	SU20B/A
Cherry/Black	SU20C/B
Cherry/Aluminum	SU20C/A
Maple/Black	SU20M/B
Maple/Aluminum	SU20M/A
Walnut/Black	SU20W/B
Walnut/Aluminum	SU20W/A

- 1 Adjustable Shelf



Single 30 - Core Module

Black/Black	SU30B/B
Black/Aluminum	SU30B/A
Cherry/Black	SU30C/B
Cherry/Aluminum	SU30C/A
Maple/Black	SU30M/B
Maple/Aluminum	SU30M/A
Walnut/Black	SU30W/B
Walnut/Aluminum	SU30W/A

- 3 Adjustable Shelves with 1 Set of Heavy Duty Shelf Brackets (hold up to 150 lbs)



Single 40 - Core Module

Black/Black	SU40B/B
Black/Aluminum	SU40B/A
Cherry/Black	SU40C/B
Cherry/Aluminum	SU40C/A
Maple/Black	SU40M/B
Maple/Aluminum	SU40M/A
Walnut/Black	SU40W/B
Walnut/Aluminum	SU40W/A

- 4 Adjustable Shelves with 1 Set of Heavy Duty Shelf Brackets (hold up to 150 lbs)



Single 20 - Extension Module

Black/Black	SX20B/B
Black/Aluminum	SX20B/A
Cherry/Black	SX20C/B
Cherry/Aluminum	SX20C/A
Maple/Black	SX20M/B
Maple/Aluminum	SX20M/A
Walnut/Black	SX20W/B
Walnut/Aluminum	SX20W/A

- 1 Adjustable Shelf



Single 30 - Extension Module

Black/Black	SX30B/B
Black/Aluminum	SX30B/A
Cherry/Black	SX30C/B
Cherry/Aluminum	SX30C/A
Maple/Black	SX30M/B
Maple/Aluminum	SX30M/A
Walnut/Black	SX30W/B
Walnut/Aluminum	SX30W/A

- 2 Adjustable Shelves with 1 Set of Heavy Duty Shelf Brackets (hold up to 150 lbs)



Single 40 - Extension Module

Black/Black	SX40B/B
Black/Aluminum	SX40B/A
Cherry/Black	SX40C/B
Cherry/Aluminum	SX40C/A
Maple/Black	SX40M/B
Maple/Aluminum	SX40M/A
Walnut/Black	SX40W/B
Walnut/Aluminum	SX40W/A

- 4 Adjustable Shelves with 1 Set of Heavy Duty Shelf Brackets (hold up to 150 lbs)

SIDES

- Choose matching side panels or mix wood sides with black, perforated steel sides to help keep equipment cool.
- Segregate bays with interior side panels (Quads order 2 sets, Triples order 1 set).
- Sold in sets of 2.



Synergy 10 Sides

Black	SS10/B
Cherry	SS10/C
Maple	SS10/M
Walnut	SS10/W
Black Perforated Steel	SS10/P
Tan Suede Leather	SS10/L

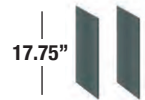

Synergy 20 Sides

Black	SS20/B
Cherry	SS20/C
Maple	SS20/M
Walnut	SS20/W
Black Perforated Steel	SS20/P
Tan Suede Leather	SS20/L

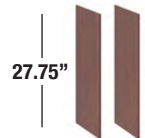

Synergy 30 Sides

Black	SS30/B
Cherry	SS30/C
Maple	SS30/M
Walnut	SS30/W
Black Perforated Steel	SS30/P
Tan Suede Leather	SS30/L



Synergy 40 Sides

Black	SS40/B
Cherry	SS40/C
Maple	SS40/M
Walnut	SS40/W
Black Perforated Steel	SS40/P
Tan Suede Leather	SS40/L

DOORS

- Can be attached to open from left or right.
- Permit Infra-red signals.
- Perforated steel panels keep equipment cool and conceal speakers.
- Door lock compatible with all doors.
- Solid hardwood frames with insert panels.
- Machined aluminum with black rubber door pull.



Synergy 10 Doors

Black/Perforated Steel	SD10B/P
Cherry/Perforated Steel	SD10C/P
Maple/Perforated Steel	SD10M/P
Walnut/Perforated Steel	SD10W/P



Synergy 20 Doors

Black/Perforated Steel	SD20B/P
Cherry/Perforated Steel	SD20C/P
Maple/Perforated Steel	SD20M/P
Walnut/Perforated Steel	SD20W/P



Synergy 30 Doors

Black/Perforated Steel	SD30B/P
Cherry/Perforated Steel	SD30C/P
Maple/Perforated Steel	SD30M/P
Walnut/Perforated Steel	SD30W/P



Synergy 40 Doors

Black/Perforated Steel	SD40B/P
Cherry/Perforated Steel	SD40C/P
Maple/Perforated Steel	SD40M/P
Walnut/Perforated Steel	SD40W/P

DRAWERS

- Metal sided with solid hardwood face.



Synergy Drawers

Black	SA/MD/B
Cherry	SA/MD/C
Maple	SA/MD/M
Walnut	SA/MD/W

• CANNOT BE PLACED BEHIND DOORS.

- Interior Dimensions: 18.375"W x 6"H x 15.75"D
- Exterior Dimensions: 19.5"W x 6.75"H x 17.5"D
- Load Capacity: 100 lbs.
- Capacity: 102 CD's or 52 DVD



Synergy Door Locks

DYI Door Lock Kit	SD/LOCK
Factory Installed Door Lock Kit	FI/SD/LOCK

- The Synergy Door Lock Kit allows you to add a lock to any Synergy Door.
- DYI kit requires drilling, bit included.



SYNERGY SYSTEM TWIN CORE MODULES

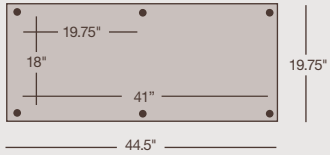

- Open Cabinets can be enclosed with Synergy Doors, Sides and Drawers.
- Infinitely Adjustable, Black Interior Shelves
- Removable Rear Panels provide easy component access.
- Heavy Duty, non-marking leveler feet are standard.
- Capacities:
 - Top (1.125" thick) holds 250 lbs.
 - Interior Shelves (3/4" thick) hold 75 lbs each (Heavy Duty Shelf Brackets hold up to 150 lbs)



Hold TV's
up to 50"



Hold up to
750 lbs

RM Rack Mount Model Available, See Page 98

W Wall Mountable, see kit on Page 103

S Speaker Integration



Twin 10 - Core Module

Black/Black	SN10B/B
Black/Aluminum	SN10B/A
Cherry/Black	SN10C/B
Cherry/Aluminum	SN10C/A
Maple/Black	SN10M/B
Maple/Aluminum	SN10M/A
Walnut/Black	SN10W/B
Walnut/Aluminum	SN10W/A

- DOES NOT include adjustable shelves.



Twin 20 - Core Module

Black/Black	SN20B/B
Black/Aluminum	SN20B/A
Cherry/Black	SN20C/B
Cherry/Aluminum	SN20C/A
Maple/Black	SN20M/B
Maple/Aluminum	SN20M/A
Walnut/Black	SN20W/B
Walnut/Aluminum	SN20W/A

- Includes 2 adjustable shelves.



Twin 30 - Core Module

Black/Black	SN30B/B
Black/Aluminum	SN30B/A
Cherry/Black	SN30C/B
Cherry/Aluminum	SN30C/A
Maple/Black	SN30M/B
Maple/Aluminum	SN30M/A
Walnut/Black	SN30W/B
Walnut/Aluminum	SN30W/A

- Includes 4 adjustable shelves with 2 Sets of Heavy Duty Shelf Brackets (hold up to 150 lbs)



Twin 40 - Core Module

Black/Black	SN40B/B
Black/Aluminum	SN40B/A
Cherry/Black	SN40C/B
Cherry/Aluminum	SN40C/A
Maple/Black	SN40M/B
Maple/Aluminum	SN40M/A
Walnut/Black	SN40W/B
Walnut/Aluminum	SN40W/A

- Includes 8 adjustable shelves with 2 sets of heavy duty shelf brackets (hold up to 150 lbs)



Twin 20 Open Center - Core Module

Black/Black	SNC20B/B
Black/Aluminum	SNC20B/A
Cherry/Black	SNC20C/B
Cherry/Aluminum	SNC20C/A
Maple/Black	SNC20M/B
Maple/Aluminum	SNC20M/A
Walnut/Black	SNC20W/B
Walnut/Aluminum	SNC20W/A

- Top Holds a Maximum of 200 lbs.
- Twin-Width Center Opening: 41"W x 8.5"H x 17.5"D
- Bottom 2 Bays: 19.75"W x 8.5"H x 18"D
- Bottom Bays accommodate Synergy 10 Doors (see page 75)



Twin 30 Open Center - Core Module

Black/Black	SNC30B/B
Black/Aluminum	SNC30B/A
Cherry/Black	SNC30C/B
Cherry/Aluminum	SNC30C/A
Maple/Black	SNC30M/B
Maple/Aluminum	SNC30M/A
Walnut/Black	SNC30W/B
Walnut/Aluminum	SNC30W/A

- Top Holds a Maximum of 200 lbs.
- Twin-Width Center Opening: 41"W x 8.5"H x 17.5"D
- Bottom 2 Bays: 19.75"W x 17.75"H x 18"D, 2 Adjustable Shelves
- Bottom Bays accommodate Synergy 20 Doors (see page 75)

SYNERGY SYSTEM TWIN RISERS & EXTENSIONS



Twin 20 - Extension Module

Black/Black	SNX20B/B
Black/Aluminum	SNX20B/A
Cherry/Black	SNX20C/B
Cherry/Aluminum	SNX20C/A
Maple/Black	SNX20M/B
Maple/Aluminum	SNX20M/A
Walnut/Black	SNX20W/B
Walnut/Aluminum	SNX20W/A

- Includes 2 adjustable shelves.



Twin 30 - Extension Module

Black/Black	SNX30B/B
Black/Aluminum	SNX30B/A
Cherry/Black	SNX30C/B
Cherry/Aluminum	SNX30C/A
Maple/Black	SNX30M/B
Maple/Aluminum	SNX30M/A
Walnut/Black	SNX30W/B
Walnut/Aluminum	SNX30W/A

- Includes 4 adjustable shelves with 2 Sets of Heavy Duty Shelf Brackets (hold up to 150 lbs)



Twin 40 - Extension Module

Black/Black	SNX40B/B
Black/Aluminum	SNX40B/A
Cherry/Black	SNX40C/B
Cherry/Aluminum	SNX40C/A
Maple/Black	SNX40M/B
Maple/Aluminum	SNX40M/A
Walnut/Black	SNX40W/B
Walnut/Aluminum	SNX40W/A

- Includes 8 adjustable shelves and 2 sets of heavy duty shelf brackets (hold up to 150 lbs.).



Twin 10 - Riser Module

Black with 8.5" Black Post	SNRB/B
Black with 8.5" Aluminum Post	SNRB/A
Cherry with 8.5" Black Post	SNRC/B
Cherry with 8.5" Aluminum Post	SNRC/A
Maple with 8.5" Black Post	SNRM/B
Maple with 8.5" Aluminum Post	SNRM/A
Walnut with 8.5" Black Post	SNRW/B
Walnut with 8.5" Aluminum Post	SNRW/A

- * Top Holds a Maximum of 200 lbs.
- Interior: 41"W x 8.5"H x 17.5"D



Twin Custom Cut - Riser Module

Black/Black	SNRXB/B
Black/Aluminum	SNRXB/A
Cherry/Black	SNRXC/B
Cherry/Aluminum	SNRXC/A
Maple/Black	SNRXM/B
Maple/Aluminum	SNRXM/A
Walnut/Black	SNRXW/B
Walnut/Aluminum	SNRXW/A

- * Top Holds a Maximum of 200 lbs.
- Includes custom cut rear panels.
- MUST specify a post height when ordering, 3 - 17.75" in increments of 1/4".
- Please allow for 1/16" tolerance.



Custom Cut Side Panels for Riser

Black	SSX20/B
Cherry	SSX20/C
Maple	SSX20/M
Walnut	SSX20/W
Tan Suede Leather	SSX20/L

- MUST specify a post height when ordering, 3 - 17.75" in increments of 1/4".
- Please allow for 1/16" tolerance.

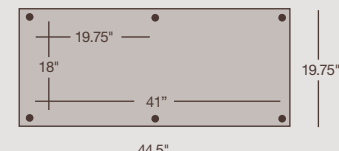

- Open Cabinets can be enclosed with Synergy Doors, Sides and Drawers.
- Infinitely Adjustable, Black Interior Shelves
- Attach to Any Synergy Twin Core Module
- Removable Rear Panels provide easy component access.
- Removable Rear Panels provide easy component access.
- Capacities:
Top (1.125" thick) holds 350 lbs.
Interior Shelves (3/4" thick) hold 75 lbs each



Hold TV's
up to 50"



Hold up to
750 lbs



Rack Mount Model
Available, See Page 98



Speaker Integration

built on





SYNERGY SYSTEM TRIPLE CORE MODULES

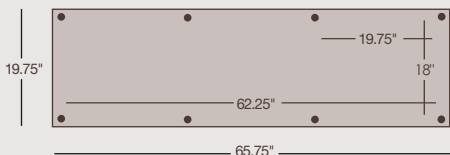

- Open Cabinets can be enclosed with Synergy Doors, Sides and Drawers.
- Removable Rear Panels provide easy component access.
- Heavy Duty, non-marking leveler feet are standard.
- Segregate Bays with 2 Interior Side Panels
- Capacities:
 - Top (1.125" thick) holds 350 lbs.
 - Interior Shelves (3/4" thick) hold 75 lbs each (Heavy Duty Shelf Brackets hold up to 150 lbs)



Hold TV's
up to 75"



Hold up to
1000 lbs

(RM) Rack Mount Model
Available, See Page 98

(W) Wall Mountable,
see kit on Page 103

(S) Speaker Integration



Triple 10 - Core Module

Black/Black	SL10B/B
Black/Aluminum	SL10B/A
Cherry/Black	SL10C/B
Cherry/Aluminum	SL10C/A
Maple/Black	SL10M/B
Maple/Aluminum	SL10M/A
Walnut/Black	SL10W/B
Walnut/Aluminum	SL10W/A

- DOES NOT include adjustable shelves.



Triple 20 - Core Module

Black/Black	SL20B/B
Black/Aluminum	SL20B/A
Cherry/Black	SL20C/B
Cherry/Aluminum	SL20C/A
Maple/Black	SL20M/B
Maple/Aluminum	SL20M/A
Walnut/Black	SL20W/B
Walnut/Aluminum	SL20W/A

- Includes 3 adjustable shelves.



Triple 30 - Core Module

Black/Black	SL30B/B
Black/Aluminum	SL30B/A
Cherry/Black	SL30C/B
Cherry/Aluminum	SL30C/A
Maple/Black	SL30M/B
Maple/Aluminum	SL30M/A
Walnut/Black	SL30W/B
Walnut/Aluminum	SL30W/A

- Includes 6 adjustable shelves with 3 Set of Heavy Duty Shelf Brackets (hold up to 150 lbs).



Triple 40 - Core Module

Black/Black	SL40B/B
Black/Aluminum	SL40B/A
Cherry/Black	SL40C/B
Cherry/Aluminum	SL40C/A
Maple/Black	SL40M/B
Maple/Aluminum	SL40M/A
Walnut/Black	SL40W/B
Walnut/Aluminum	SL40W/A

- Includes 9 adjustable shelves with 3 sets of heavy duty shelf brackets (hold up to 150 lbs)



Triple 20 Open Center - Core Module

Black/Black	SLC20B/B
Black/Aluminum	SLC20B/A
Cherry/Black	SLC20C/B
Cherry/Aluminum	SLC20C/A
Maple/Black	SLC20M/B
Maple/Aluminum	SLC20M/A
Walnut/Black	SLC20W/B
Walnut/Aluminum	SLC20W/A

- *Top Holds a Maximum of 150 lbs.
- Triple-Width Center Opening: 62.25"W x 7.5"H x 17.5"
- Bottom 3 Bays: 19.75"W x 8.5"H x 18"D
- Bottom Bays accommodate Synergy 10 Doors (see page 75)



Triple 30 Open Center - Core Module

Black/Black	SLC30B/B
Black/Aluminum	SLC30B/A
Cherry/Black	SLC30C/B
Cherry/Aluminum	SLC30C/A
Maple/Black	SLC30M/B
Maple/Aluminum	SLC30M/A
Walnut/Black	SLC30W/B
Walnut/Aluminum	SLC30W/A

- Top Holds a Maximum of 150 lbs.
- Triple-Width Center Opening: 62.25"W x 8.25"H x 17.5"
- Bottom 3 Bays: 19.75"W x 17.75"H x 18"D, 3 Adjustable Shelves
- Bottom Bays accommodate Synergy 20 Doors (see page 75)



Triple 20 - Extension Module

Black/Black	SLX20B/B
Black/Aluminum	SLX20B/A
Cherry/Black	SLX20C/B
Cherry/Aluminum	SLX20C/A
Maple/Black	SLX20M/B
Maple/Aluminum	SLX20M/A
Walnut/Black	SLX20W/B
Walnut/Aluminum	SLX20W/A

- Includes 3 adjustable shelves.



Triple 30 - Extension Module

Black/Black	SLX30B/B
Black/Aluminum	SLX30B/A
Cherry/Black	SLX30C/B
Cherry/Aluminum	SLX30C/A
Maple/Black	SLX30M/B
Maple/Aluminum	SLX30M/A
Walnut/Black	SLX30W/B
Walnut/Aluminum	SLX30W/A

- Includes 6 adjustable shelves with 3 sets of heavy duty shelf brackets (hold up to 150 lbs)



Triple 10 - Riser Module

Black/Black	SLRB/A
Black/Aluminum	SLRB/A
Cherry/Black	SLRC/B
Cherry/Aluminum	SLRC/A
Maple/Black	SLRM/B
Maple/Aluminum	SLRM/A
Walnut/Black	SLRW/B
Walnut/Aluminum	SLRW/A

- * Top Holds a Maximum of 125 lbs.
- Interior: 62.25"W x 8.5"H x 17.5"D



Triple Custom Cut - Riser Module

Black/Black	SLRXB/B
Black/Aluminum	SLRXB/A
Cherry/Black	SLRXC/B
Cherry/Aluminum	SLRXC/A
Maple/Black	SLRXM/B
Maple/Aluminum	SLRXM/A
Walnut/Black	SLRXW/B
Walnut/Aluminum	SLRXW/A

- * Top Holds a Maximum of 125 lbs.
- Includes custom cut rear panels.
- MUST specify a post height when ordering, 3 - 17.75" in increments of 1/4".
- Please allow for 1/16" tolerance.



Custom Cut Side Panels for Riser

Black	SSX20/B
Cherry	SSX20/C
Maple	SSX20/M
Walnut	SSX20/W
Tan Suede Leather	SSX20/L

- MUST specify a post height when ordering, 3 - 17.75" in increments of 1/4".
- Please allow for 1/16" tolerance.

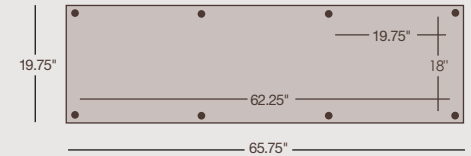

- Open Cabinets can be enclosed with Synergy Doors, Sides and Drawers.
- Infinitely Adjustable, Black Interior Shelves
- Attach to Any Synergy Triple Core Module
- Segregate Bays with 1 Interior Side Panel
- Removable Rear Panels provide easy component access.
- Capacities:
 Top (1.125" thick) holds 350 lbs.
 Interior Shelves (3/4" thick) hold 75 lbs each
 (Heavy Duty Shelf Brackets hold up to 150 lbs)



Hold TV's
up to 75"



Hold up to
1000 lbs



Rack Mount Model
Available, See Page 98



Speaker Integration

built on





SYNERGY SYSTEM QUAD MODULES

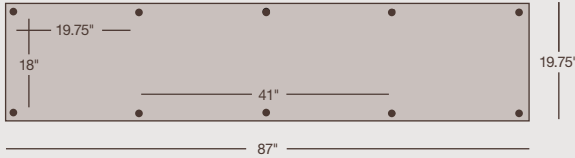

- Open Cabinets can be enclosed with Synergy Doors, Sides and Drawers.
- Removable Rear Panels provide easy component access.
- Heavy Duty, non-marking leveler feet are standard.
- Segregate Bays with 1 Interior Side Panel
- Capacities:
 - Top (1.125" thick) holds 350 lbs.
 - Interior Shelves (3/4" thick) hold 75 lbs each (Heavy Duty Shelf Brackets hold up to 150 lbs)



Hold TV's
up to 90"



Hold up to
1000 lbs



Quad 10 - Core Module

Black/Black	SQ10B/B
Black/Aluminum	SQ10B/A
Cherry/Black	SQ10C/B
Cherry/Aluminum	SQ10C/A
Maple/Black	SQ10M/B
Maple/Aluminum	SQ10M/A
Walnut/Black	SQ10W/B
Walnut/Aluminum	SQ10W/A

- DOES NOT include adjustable shelves.



Quad 20 - Core Module

Black/Black	SQ20B/B
Black/Aluminum	SQ20B/A
Cherry/Black	SQ20C/B
Cherry/Aluminum	SQ20C/A
Maple/Black	SQ20M/B
Maple/Aluminum	SQ20M/A
Walnut/Black	SQ20W/B
Walnut/Aluminum	SQ20W/A

- Includes 4 adjustable shelves.



Quad 20 Open Center - Core Module

Black/Black	SQC20B/B
Black/Aluminum	SQC20B/A
Cherry/Black	SQC20C/B
Cherry/Aluminum	SQC20C/A
Maple/Black	SQC20M/B
Maple/Aluminum	SQC20M/A
Walnut/Black	SQC20W/B
Walnut/Aluminum	SQC20W/A

- Includes 2 adjustable shelves.



Quad 30 - Core Module

Black/Black	SQ30B/B
Black/Aluminum	SQ30B/A
Cherry/Black	SQ30C/B
Cherry/Aluminum	SQ30C/A
Maple/Black	SQ30M/B
Maple/Aluminum	SQ30M/A
Walnut/Black	SQ30W/B
Walnut/Aluminum	SQ30W/A

- Includes 8 adjustable shelves with 4 sets of heavy duty shelf brackets (hold up to 150 lbs)



Quad 30 Open Center - Core Module

Black/Black	SQC30B/B
Black/Aluminum	SQC30B/A
Cherry/Black	SQC30C/B
Cherry/Aluminum	SQC30C/A
Maple/Black	SQC30M/B
Maple/Aluminum	SQC30M/A
Walnut/Black	SQC30W/B
Walnut/Aluminum	SQC30W/A

- Includes 8 adjustable shelves.

W Wall Mountable,
see kit on Page 103

Speaker Integration



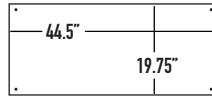

Synergy Bridge Three

Black	SB3/B
Cherry	SB3/C
Maple	SB3/M
Walnut	SB3/W

- Holds TV's Up To 46".
- Total Maximum Weight Capacity: 100 lbs.
- 46" Maximum Width with Brackets Fully Extended
- 1.125" Thick

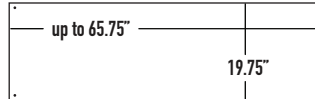

Synergy Custom Cut Bridge

Black	SBX/B
Cherry	SBX/C
Maple	SBX/M
Walnut	SBX/W

- Must provide actual TV width and we add 1" for clearance (67.75" Max.)
- Total Maximum Weight Capacity: 100 lbs.
- 1.125" Thick

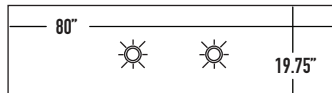

Synergy Plank Bridge with Lights

Black	SBP/B
Cherry	SBP/C
Maple	SBP/M
Walnut	SBP/W

- Rests on top of two Synergy towers and spans TV's up to 72".
- Includes recessed puck lights.
- Total Maximum Weight Capacity: 150 lbs.
- 2.5" Thick
- *While supplies last.*



Synergy Amplifier Stand

Black	SAMP/B
Cherry	SAMP/C
Maple	SAMP/M
Walnut	SAMP/W

- Total Maximum Weight Capacity: 250 lbs.
- Includes 3" Polished Aluminum Claw Feet
- 23.25" x 19.75" x 4.5"



SYNERGY™

PRE-CONFIGURED SOLUTIONS

AVAILABLE IN: WALNUT, BLACK, CHERRY & MAPLE
WITH BLACK PERFORATED STEEL DOORS



Synergy Single 303

Black/Black	SB303B/B
Black/Aluminum	SB303B/A
Cherry/Black	SB303C/B
Cherry/Aluminum	SB303C/A
Maple/Black	SB303M/B
Maple/Aluminum	SB303M/A
Walnut/Black	SB303W/B
Walnut/Aluminum	SB303W/A

23.25" w x 31" h x 19.75" d
• 3 Adjustable Shelves



Synergy Single 402

Black/Black	SB402B/B
Black/Aluminum	SB402B/A
Cherry/Black	SB402C/B
Cherry/Aluminum	SB402C/A
Maple/Black	SB402M/B
Maple/Aluminum	SB402M/A
Walnut/Black	SB402W/B
Walnut/Aluminum	SB402W/A

23.25" w x 41" h x 19.75" d
• 4 Adjustable Shelves



Synergy Single 603

Black/Black	603B/B
Black/Aluminum	603B/A
Cherry/Black	603C/B
Cherry/Aluminum	603C/A
Maple/Black	603M/B
Maple/Aluminum	603M/A
Walnut/Black	603W/B
Walnut/Aluminum	603W/A

23.25" w x 60" h x 19.75" d
• 4 Adjustable Shelves



Synergy Single 703

Black/Black	703B/B
Black/Aluminum	703B/A
Cherry/Black	703C/B
Cherry/Aluminum	703C/A
Maple/Black	703M/B
Maple/Aluminum	703M/A
Walnut/Black	703W/B
Walnut/Aluminum	703W/A

23.25" w x 70" h x 19.75" d
• 7 Adjustable Shelves



Synergy Twin 221

Black/Black	SB221B/B
Black/Aluminum	SB221B/A
Cherry/Black	SB221C/B
Cherry/Aluminum	SB221C/A
Maple/Black	SB221M/B
Maple/Aluminum	SB221M/A
Walnut/Black	SB221W/B
Walnut/Aluminum	SB221W/A

44.5" w x 21" h x 19.75" d
• 2 Adjustable Shelves



Synergy Twin 229

Black/Black	SB229B/B
Black/Aluminum	SB229B/A
Cherry/Black	SB229C/B
Cherry/Aluminum	SB229C/A
Maple/Black	SB229M/B
Maple/Aluminum	SB229M/A
Walnut/Black	SB229W/B
Walnut/Aluminum	SB229W/A

44.5" w x 21" h x 19.75" d
Center Opening 41" w x 18" d x 8.5" h



Synergy Twin 323

Black/Black	SB323B/B
Black/Aluminum	SB323B/A
Cherry/Black	SB323C/B
Cherry/Aluminum	SB323C/A
Maple/Black	SB323M/B
Maple/Aluminum	SB323M/A
Walnut/Black	SB323W/B
Walnut/Aluminum	SB323W/A

44.5" w x 31" h x 19.75" d
• 4 Adjustable Shelves



Synergy Twin 329

Black/Black	SB329B/B
Black/Aluminum	SB329B/A
Cherry/Black	SB329C/B
Cherry/Aluminum	SB329C/A
Maple/Black	SB329M/B
Maple/Aluminum	SB329M/A
Walnut/Black	SB329W/B
Walnut/Aluminum	SB329W/A

44.5" w x 31" h x 19.75" d
• 2 Adjustable Shelves



Synergy Triple 132

Black/Black	SB132B/B
Black/Aluminum	SB132B/A
Cherry/Black	SB132C/B
Cherry/Aluminum	SB132C/A
Maple/Black	SB132M/B
Maple/Aluminum	SB132M/A
Walnut/Black	SB132W/B
Walnut/Aluminum	SB132W/A

65.75" w x 12" h x 19.75" d
Center Opening 19.75" w x 18" d x 8.5" h



Synergy Triple 133

Black/Black	SB133B/B
Black/Aluminum	SB133B/A
Cherry/Black	SB133C/B
Cherry/Aluminum	SB133C/A
Maple/Black	SB133M/B
Maple/Aluminum	SB133M/A
Walnut/Black	SB133W/B
Walnut/Aluminum	SB133W/A

65.75" w x 12" h x 19.75" d



Synergy Triple 237

Black/Black	SB237B/B
Black/Aluminum	SB237B/A
Cherry/Black	SB237C/B
Cherry/Aluminum	SB237C/A
Maple/Black	SB237M/B
Maple/Aluminum	SB237M/A
Walnut/Black	SB237W/B
Walnut/Aluminum	SB237W/A

65.75" w x 21" h x 19.75" d
• 3 Adjustable Shelves

W Wall Mountable,
see kit on Page 103

S Speaker Integration



PRE-CONFIGURED SOLUTIONS

See Interior Specs on Page 84



Synergy Triple 236

Black/Black	SB236B/B
Black/Aluminum	SB236B/A
Cherry/Black	SB236C/B
Cherry/Aluminum	SB236C/A
Maple/Black	SB236M/B
Maple/Aluminum	SB236M/A
Walnut/Black	SB236W/B
Walnut/Aluminum	SB236W/A

65.75" w x 21" h x 19.75" d

- 2 Adjustable Shelves
- Center Speaker / Multi-Functional Compartment
- 1 Drawer



Synergy Triple 339

Black/Black	SB339B/B
Black/Aluminum	SB339B/A
Cherry/Black	SB339C/B
Cherry/Aluminum	SB339C/A
Maple/Black	SB339M/B
Maple/Aluminum	SB339M/A
Walnut/Black	SB339W/B
Walnut/Aluminum	SB339W/A

65.75" w x 31" h x 19.75" d

- 3 Adjustable Shelves
- Center Speaker / Multi-Functional Compartment



Synergy Triple 337

Black/Black	SB337B/B
Black/Aluminum	SB337B/A
Cherry/Black	SB337C/B
Cherry/Aluminum	SB337C/A
Maple/Black	SB337M/B
Maple/Aluminum	SB337M/A
Walnut/Black	SB337W/B
Walnut/Aluminum	SB337W/A

65.75" w x 31" h x 19.75" d

- 6 Adjustable Shelves



Synergy Quad 147

Black/Black	147B/B
Black/Aluminum	147B/A
Cherry/Black	147C/B
Cherry/Aluminum	147C/A
Maple/Black	147M/B
Maple/Aluminum	147M/A
Walnut/Black	147W/B
Walnut/Aluminum	147W/A

87" w x 12" h x 19.75" d



Synergy Quad 245

Black/Black	245B/B
Black/Aluminum	245B/A
Cherry/Black	245C/B
Cherry/Aluminum	245C/A
Maple/Black	245M/B
Maple/Aluminum	245M/A
Walnut/Black	245W/B
Walnut/Aluminum	245W/A

87" w x 21" h x 19.75" d

- 2 Adjustable Shelves
- Center Speaker / Multi-Functional Compartment



Synergy Quad 247

Black/Black	247B/B
Black/Aluminum	247B/A
Cherry/Black	247C/B
Cherry/Aluminum	247C/A
Maple/Black	247M/B
Maple/Aluminum	247M/A
Walnut/Black	247W/B
Walnut/Aluminum	247W/A

87" w x 21" h x 19.75" d

- 4 Adjustable Shelves



Synergy Quad 248

Black/Black	248B/B
Black/Aluminum	248B/A
Cherry/Black	248C/B
Cherry/Aluminum	248C/A
Maple/Black	248M/B
Maple/Aluminum	248M/A
Walnut/Black	248W/B
Walnut/Aluminum	248W/A

87" w x 21" h x 19.75" d

- 2 Adjustable Shelves
- Center Speaker / Multi-Functional Compartment



Synergy Quad 345

Black/Black	345B/B
Black/Aluminum	345B/A
Cherry/Black	345C/B
Cherry/Aluminum	345C/A
Maple/Black	345M/B
Maple/Aluminum	345M/A
Walnut/Black	345W/B
Walnut/Aluminum	345W/A

87" w x 31" h x 19.75" d

- 6 Adjustable Shelves
- Center Speaker / Multi-Functional Compartment



Synergy Quad 347

Black/Black	347B/B
Black/Aluminum	347B/A
Cherry/Black	347C/B
Cherry/Aluminum	347C/A
Maple/Black	347M/B
Maple/Aluminum	347M/A
Walnut/Black	347W/B
Walnut/Aluminum	347W/A

87" w x 31" h x 19.75" d

- 8 Adjustable Shelves

 Wall Mountable, see kit on Page 103

 Speaker Integration



SYNERGY[®]

SPECIFICATIONS



303

Rec. TV Size: up to 40"
Top Holds: 350 lbs

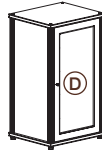

402

Rec. TV Size: up to 40"
Top Holds: 350 lbs



603

Top Holds: 350 lbs



703

Top Holds: 350 lbs

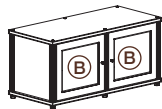

221

Rec. TV Size: up to 50"
Top Holds: 350 lbs



229

Rec. TV Size: up to 50"
Top Holds: 350 lbs

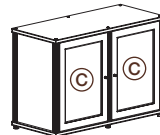

323

Rec. TV Size: up to 50"
Top Holds: 350 lbs

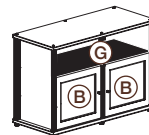

329

Rec. TV Size: up to 50"
Top Holds: 200 lbs

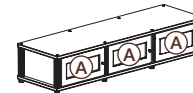

132 & 133

Rec. TV Size: up to 75"
Top Holds: 350 lbs

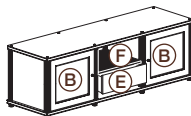

236

Rec. TV Size: up to 75"
Top Holds: 350 lbs

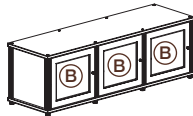

237

Rec. TV Size: up to 75"
Top Holds: 350 lbs

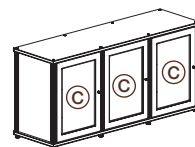

337

Rec. TV Size: up to 75"
Top Holds: 350 lbs

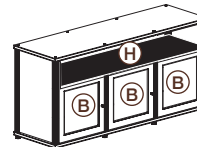

339

Rec. TV Size: up to 75"
Top Holds: 150 lbs

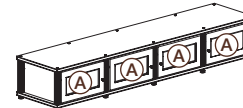

147

Rec. TV Size: up to 90"
Top Holds: 350 lbs

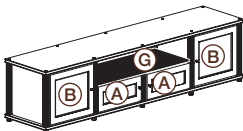

245

Rec. TV Size: up to 90"
Top Holds: 350 lbs

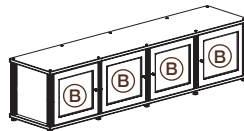

247

Rec. TV Size: up to 90"
Top Holds: 350 lbs

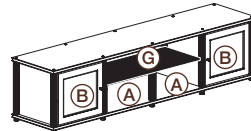

248

Rec. TV Size: up to 90"
Top Holds: 350 lbs

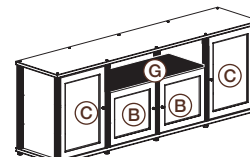

345

Rec. TV Size: up to 90"
Top Holds: 350 lbs

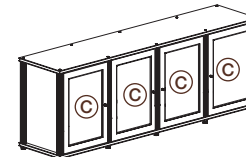

347

Rec. TV Size: up to 90"
Top Holds: 350 lbs

Single-Width Compartments

- A** 19.75"W x 18"D x 8.5"H
- B** 19.75"W x 18"D x 17.75"H
- C** 19.75"W x 18"D x 27.75"H
- D** 19.75"W x 18"D x 37.75"H

E Media Drawer

8.625"W x 18"D x 7.75"H
Holds 75 DVD's or 111 CD's

F Single-Width Center Speaker, Multi-Functional Compartment

19.75"W x 18"D x 8.5"H

G Double-Width Center Speaker, Multi-Functional Compartment

41"W x 18"D x 8.5"H

H Triple-Width Center Speaker, Multi-Functional Compartment

62.25"W x 17.5"D x 7.5"H

SYNERGY[®]

PRO AUDIO SYSTEM

A fully modular pro audio system that takes customization to a whole new level. A virtually limitless number of configurations and an extensive range of accessories allow you to create highly personalized Pro Audio racks and cabinets with premium components that will deliver exceptional reliability and durability. Mounts are compatible with industry standard, EIA 19" components.



SYNERGY™

PRO AUDIO MODULAR RACKS



The anodized aluminum supports are the core of the extremely durable modular system.

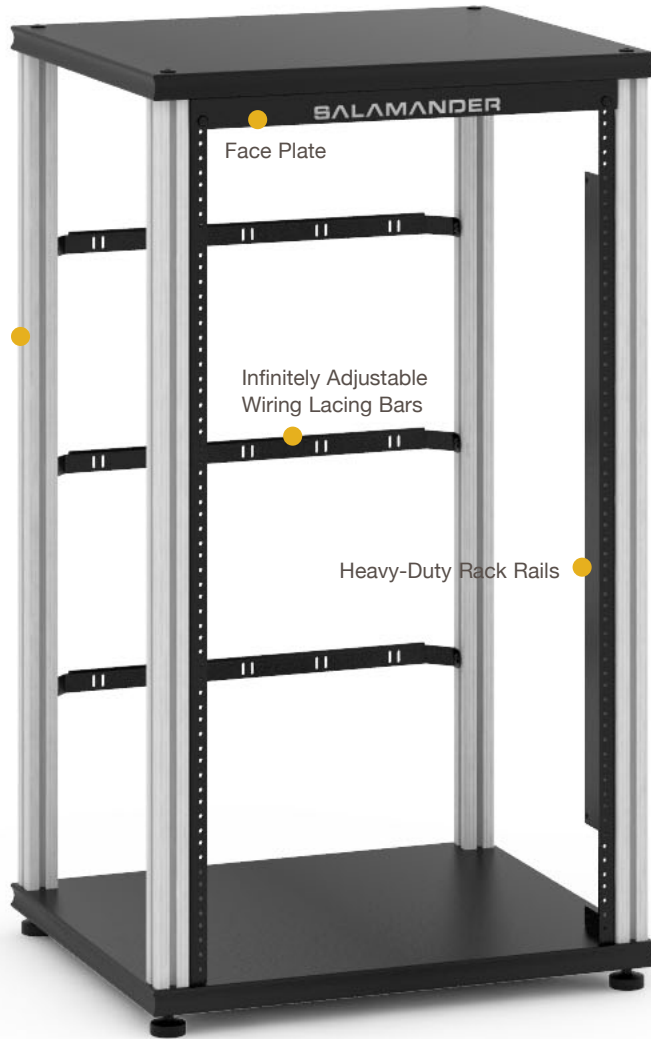
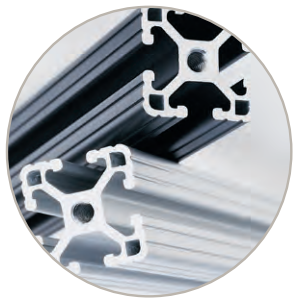

Model	Rack Units	Top Capacity	Maximum Capacity
SINGLE 20	10	150 lbs.	500 lbs.
SINGLE 30	15	150 lbs.	500 lbs.
SINGLE 40	21	150 lbs.	500 lbs.
TWIN 20	20	250 lbs.	750 lbs.
TWIN 30	30	250 lbs.	750 lbs.
TWIN 40	42	250 lbs.	750 lbs.
TRIPLE 20	30	350 lbs.	1000 lbs.
TRIPLE 30	45	350 lbs.	1000 lbs.
TRIPLE 40	63	350 lbs.	1000 lbs.

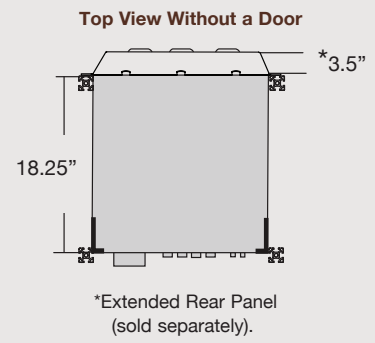
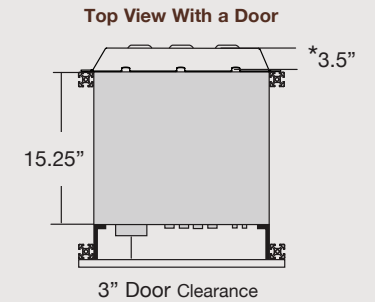



Single 20 Rack Mount - Core Module

Black/Black	SU20RMB/B
Black/Aluminum	SU20RMB/A
Cherry/Black	SU20RMC/B
Cherry/Aluminum	SU20RMC/A
Maple/Black	SU20RMM/B
Maple/Aluminum	SU20RMM/A
Walnut/Black	SU20RMW/B
Walnut/Aluminum	SU20RMW/A

- Holds up to 10 U's.
- Includes 1 Lacing Bar



Single 30 Rack Mount - Core Module

Black/Black	SU30RMB/B
Black/Aluminum	SU30RMB/A
Cherry/Black	SU30RMC/B
Cherry/Aluminum	SU30RMC/A
Maple/Black	SU30RMM/B
Maple/Aluminum	SU30RMM/A
Walnut/Black	SU30RMW/B
Walnut/Aluminum	SU30RMW/A

- Holds up to 15 U's.
- Includes 2 Lacing Bars



Single 40 Rack Mount - Core Module

Black/Black	SU40RMB/B
Black/Aluminum	SU40RMB/A
Cherry/Black	SU40RMC/B
Cherry/Aluminum	SU40RMC/A
Maple/Black	SU40RMM/B
Maple/Aluminum	SU40RMM/A
Walnut/Black	SU40RMW/B
Walnut/Aluminum	SU40RMW/A

- Holds up to 21 U's.
- Includes 3 Lacing Bars



Single 20 Rack Mount - Extension Module

Black/Black	SX20RMB/B
Black/Aluminum	SX20RMB/A
Cherry/Black	SX20RMC/B
Cherry/Aluminum	SX20RMC/A
Maple/Black	SX20RMM/B
Maple/Aluminum	SX20RMM/A
Walnut/Black	SX20RMW/B
Walnut/Aluminum	SX20RMW/A

- Holds up to 10 U's.
- Includes 1 Lacing Bar



Single 30 Rack Mount - Extension Module

Black/Black	SX30RMB/B
Black/Aluminum	SX30RMB/A
Cherry/Black	SX30RMC/B
Cherry/Aluminum	SX30RMC/A
Maple/Black	SX30RMM/B
Maple/Aluminum	SX30RMM/A
Walnut/Black	SX30RMW/B
Walnut/Aluminum	SX30RMW/A

- Holds up to 15 U's.
- Includes 2 Lacing Bars



Single 40 Rack Mount - Extension Module

Black/Black	SX40RMB/B
Black/Aluminum	SX40RMB/A
Cherry/Black	SX40RMC/B
Cherry/Aluminum	SX40RMC/A
Maple/Black	SX40RMM/B
Maple/Aluminum	SX40RMM/A
Walnut/Black	SX40RMW/B
Walnut/Aluminum	SX40RMW/A

- Holds up to 21 U's.
- Includes 3 Lacing Bars

built on



FRAME

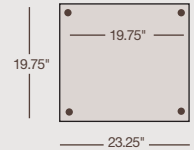

- Heavy duty rack rails.
- Open modules can be enclosed with Doors and Sides
- Rear wire lacing bars included. No rear panel.
- Heavy Duty, non-marking leveler feet are standard.
- Top (1.125" thick) holds 150 lbs.
- Faceplate included.
- Optional Rack Rails may be added to the rear.



Hold TV's
up to 40"



Hold up to
500 lbs

Wire Management See Page 99 for Accessories.





SYNERGY SYSTEM

TWIN PRO AUDIO MODULES

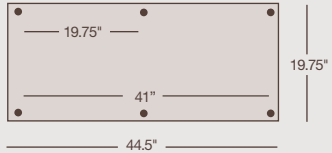

- Heavy duty rack rails.
- Open modules can be enclosed with Doors and Sides
- Rear wire lacing bars included. No rear panels.
- Heavy Duty, non-marking leveler feet are standard.
- Top (1.125" thick) holds 250 lbs.
- Faceplate included.



Hold TV's
up to 50"



Hold up to
750 lbs

Vented Rack Mount Shelves

See Page 99 for Accessories.



Twin 20 Rack Mount - Core Module

Black/Black	SN20RMB/B
Black/Aluminum	SN20RMB/A
Cherry/Black	SN20RMC/B
Cherry/Aluminum	SN20RMC/A
Maple/Black	SN20RMM/B
Maple/Aluminum	SN20RMM/A
Walnut/Black	SN20RMW/B
Walnut/Aluminum	SN20RMW/A

- Holds up to 20 U's.
- Includes 2 Lacing Bars



Twin 30 Rack Mount - Core Module

Black/Black	SN30RMB/B
Black/Aluminum	SN30RMB/A
Cherry/Black	SN30RMC/B
Cherry/Aluminum	SN30RMC/A
Maple/Black	SN30RMM/B
Maple/Aluminum	SN30RMM/A
Walnut/Black	SN30RMW/B
Walnut/Aluminum	SN30RMW/A

- Holds up to 30 U's.
- Includes 4 Lacing Bars



Twin 40 Rack Mount - Core Module

Black/Black	SN40RMB/B
Black/Aluminum	SN40RMB/A
Cherry/Black	SN40RMC/B
Cherry/Aluminum	SN40RMC/A
Maple/Black	SN40RMM/B
Maple/Aluminum	SN40RMM/A
Walnut/Black	SN40RMW/B
Walnut/Aluminum	SN40RMW/A

- Holds up to 42 U's.
- Includes 6 Lacing Bars



Twin 20 Rack Mount - Extension Module

Black/Black	SNX20RMB/B
Black/Aluminum	SNX20RMB/A
Cherry/Black	SNX20RMC/B
Cherry/Aluminum	SNX20RMC/A
Maple/Black	SNX20RMM/B
Maple/Aluminum	SNX20RMM/A
Walnut/Black	SNX20RMW/B
Walnut/Aluminum	SNX20RMW/A

- Holds up to 20 U's.
- Includes 2 Lacing Bars



Twin 30 Rack Mount - Extension Module

Black/Black	SNX30RMB/B
Black/Aluminum	SNX30RMB/A
Cherry/Black	SNX30RMC/B
Cherry/Aluminum	SNX30RMC/A
Maple/Black	SNX30RMM/B
Maple/Aluminum	SNX30RMM/A
Walnut/Black	SNX30RMW/B
Walnut/Aluminum	SNX30RMW/A

- Holds up to 30 U's.
- Includes 4 Lacing Bars



Twin 40 Rack Mount - Extension Module

Black/Black	SNX40RMB/B
Black/Aluminum	SNX40RMB/A
Cherry/Black	SNX40RMC/B
Cherry/Aluminum	SNX40RMC/A
Maple/Black	SNX40RMM/B
Maple/Aluminum	SNX40RMM/A
Walnut/Black	SNX40RMW/B
Walnut/Aluminum	SNX40RMW/A

- Holds up to 42 U's.
- Includes 6 Lacing Bars



TRIPLE PRO AUDIO MODULES



Triple 20 Rack Mount - Core Module

Black/Black	SL20RMB/B
Black/Aluminum	SL20RMB/A
Cherry/Black	SL20RMC/B
Cherry/Aluminum	SL20RMC/A
Maple/Black	SL20RMM/B
Maple/Aluminum	SL20RMM/A
Walnut/Black	SL20RMW/B
Walnut/Aluminum	SL20RMW/A

- Holds up to 30 U's.
- Includes 3 Lacing Bars



Triple 30 Rack Mount - Core Module

Black/Black	SL30RMB/B
Black/Aluminum	SL30RMB/A
Cherry/Black	SL30RMC/B
Cherry/Aluminum	SL30RMC/A
Maple/Black	SL30RMM/B
Maple/Aluminum	SL30RMM/A
Walnut/Black	SL30RMW/B
Walnut/Aluminum	SL30RMW/A

- Holds up to 45 U's.
- Includes 6 Lacing Bars



Triple 40 Rack Mount - Core Module

Black/Black	SL40RMB/B
Black/Aluminum	SL40RMB/A
Cherry/Black	SL40RMC/B
Cherry/Aluminum	SL40RMC/A
Maple/Black	SL40RMM/B
Maple/Aluminum	SL40RMM/A
Walnut/Black	SL40RMW/B
Walnut/Aluminum	SL40RMW/A

- Holds up to 63 U's.
- Includes 9 Lacing Bars



Triple 20 Rack Mount - Extension Module

Black/Black	SLX20RMB/B
Black/Aluminum	SLX20RMB/A
Cherry/Black	SLX20RMC/B
Cherry/Aluminum	SLX20RMC/A
Maple/Black	SLX20RMM/B
Maple/Aluminum	SLX20RMM/A
Walnut/Black	SLX20RMW/B
Walnut/Aluminum	SLX20RMW/A

- Holds up to 30 U's.
- Includes 3 Lacing Bars



Triple 30 Rack Mount - Extension Module

Black/Black	SLX30RMB/B
Black/Aluminum	SLX30RMB/A
Cherry/Black	SLX30RMC/B
Cherry/Aluminum	SLX30RMC/A
Maple/Black	SLX30RMM/B
Maple/Aluminum	SLX30RMM/A
Walnut/Black	SLX30RMW/B
Walnut/Aluminum	SLX30RMW/A

- Holds up to 45 U's.
- Includes 6 Lacing Bars



Triple 40 Rack Mount - Extension Module

Black/Black	SLX40RMB/B
Black/Aluminum	SLX40RMB/A
Cherry/Black	SLX40RMC/B
Cherry/Aluminum	SLX40RMC/A
Maple/Black	SLX40RMM/B
Maple/Aluminum	SLX40RMM/A
Walnut/Black	SLX40RMW/B
Walnut/Aluminum	SLX40RMW/A

- Holds up to 63 U's.
- Includes 9 Lacing Bars



- Heavy duty rack rails.
- Open modules can be enclosed with Doors and Sides
- Rear wire lacing bars included. No rear panels.
- Heavy Duty, non-marking leveler feet are standard.
- Top (1.125" thick) holds 350 lbs.
- Faceplate included.



Hold TV's
up to 75"



Hold up to
1000 lbs



Vented Rack Mount Face Plates

See Page 99 for Accessories.

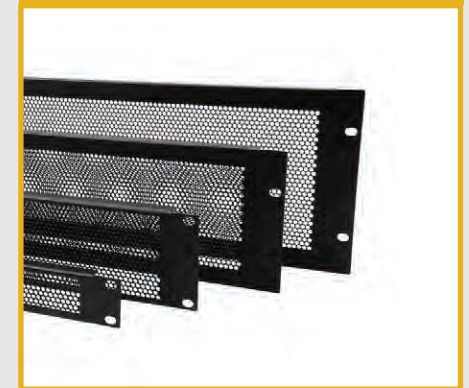



ARCHETYPE™

SYSTEM



ARCHETYPE™

MODULAR SYSTEM

The Archetype System™ is an innovative modular shelving system for audio/video equipment. Infinitely adjustable, it allows anyone to create a wide array of shelving possibilities.

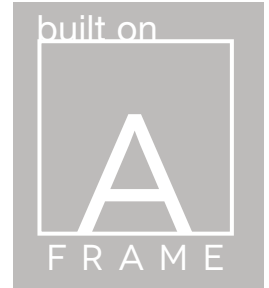

DESIGNING AN ARCHETYPE SYSTEM™

1. Determine Number of Shelves and Height

Audio stands are available in three standard heights (20, 28, 36") and can be extended by stacking units or building with rod and couplers.

2. Select Wood

Solid real woods such as Natural Cherry, Natural Maple, Natural Walnut or Black on MDF.

3. Accessorize

Storage options available.

4. Enhance Footing

Wheels for mobility and spikes to reduce vibration.

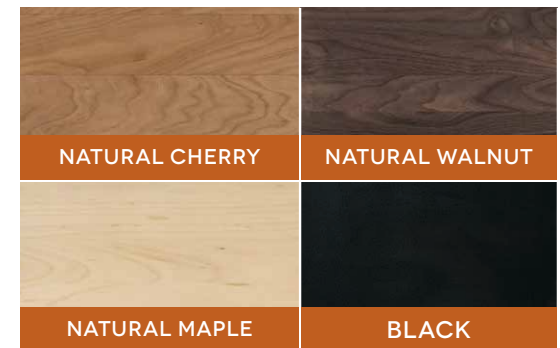

MODULAR

Threaded steel support rods and matching fasteners allow shelves to be fully adjustable while allowing customers to stack units or add individual shelves as needed.

FUNCTIONAL

An Audiophile favorite that has earned "Recommended Component" status from Stereophile magazine, the system includes accessories like Dual-Wheel Casters, Arched Bookends and Drawers that also make it suitable for general shelving.

SURFACE

The 3/4-inch shelves and solid steel posts are rigid and strong enough to support 150 pounds each. Metal and neoprene spacers sandwich shelf corners, further isolating contents from vibration. Select from three attractive, solid hardwood shelf panels (cherry, maple, walnut) or a black MDF panel.



ARCHETYPE SYSTEM

Archetype Shelf Dimensions

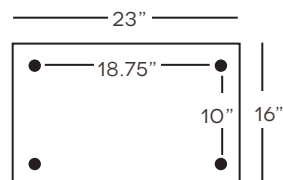

Archetype 2.0

Black	A2/B
Cherry	A2/C
Maple	A2/M
Walnut	A2/W

- Includes 2 shelves.



Archetype 3.0

Black	A3/B
Cherry	A3/C
Maple	A3/M
Walnut	A3/W

- Includes 3 shelves.



Archetype 5.0

Black	A5/B
Cherry	A5/C
Maple	A5/M
Walnut	A5/W

- Includes 5 shelves.



Shelves

Black	SS/B
Cherry	SS/C
Maple	SS/M
Walnut	SS/W

- Weight Capacity: 150 lbs.
- 23" x 16" x .75"
- Hardware Included

Amplifier Stand

Black	AMP/B
Cherry	AMP/C
Maple	AMP/M
Walnut	AMP/W

- Includes Solid Steel, Mega Spikes and floor protectors



Stacking Coupler Kit

Set of 4, Black	STACK
-----------------	-------

- Use to extend or stack any two Archetype units.



Drawer

Black	DRAWER
Silver	DRAWER/S

- Capacity: 100 CD's, 22 DVD's
- Load Capacity: 100 lbs.
- Interior Dimensions: 18"W x 6.75"H x 15.75"D



Saturn Wheels

Set of 4, Satin Chrome	SATURN/A
Set of 4, Satin Black	SATURN/B

- Weight Capacity: 400 lbs. per set.
- Adds 3.75" to height.
- Set includes locking wheels.



Dual Wheel Casters

Set of 4, Black	WHEEL
-----------------	-------

- CAUTION: Tall, top heavy units should not use wheels for frequent movement.
- Weight Capacity: 200 lbs. per set.
- Adds 3" to height.
- Set includes locking wheels.



Mega Spikes

Set of 4, Black	SPIKE
-----------------	-------

- Performance enhancing heavy duty, machined, solid steel.
- Weight Capacity: 800 lbs.
- Includes floor protector pads.
- Adds 2.25" to height.



Bookends

Set of 4, Black	ARCH
-----------------	------

- Easy way to support CD's/DVD's, LP's and books.



Threaded Rods

Archetype 2.0 - 20", Black	300-060
Archetype 3.0 - 28", Black	300-050
Archetype 5.0 - 36", Black	300-040

- Use with stacking kit to extend Archetype units.
- Sold individually.





AV FURNITURE ACCESSORIES

Integrated TV Mounts	94
Integrated Speakers	95
Interior Storage	96
In-Cabinet Refrigerator	97
Pro Rack Mounting	98
Active Cooling	100
Rear Panels	100
Integrated Power	101
Footing	102
Wall Mounting Kit	103
Accent Lighting	104
IR Repeater	104
Security Lock and Panels	104

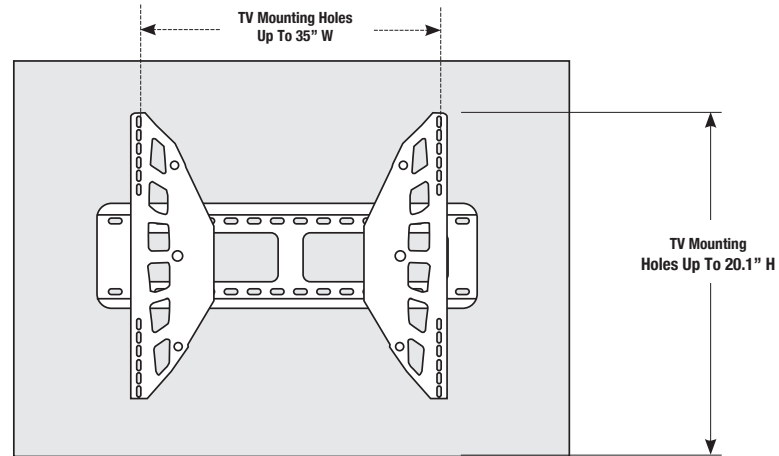

FX 100

FX100 series of integrated cabinet mount is designed to affix TVs to cabinets without the hassle of on-wall wiring and installation.

- Universal TV Mounts
- All TV mounts include cable managers.

Synergy	Vesa Pattern
Twin	min 100x100, 500x300 max
Triple	min 200x200, 800x500 max
Quad	min 300x300, 900x600 max
Chameleon	Vesa Pattern
Twin	min 200x200, 800x500 max
Triple	min 200x200, 800x500 max
Quad	min 300x300, 900x600 max



Synergy System - FX100 TV Mounts

For Twin Cabinet, Black	SN/PM2/B
For Triple Cabinet, Black	SL/PM2/B
For Quad Cabinet, Black	SQ/PM2/B

* Clearance Below TV - A = 23.5 minus 1/2 of TV Height (This assumes vertical brackets are centered on TV.)

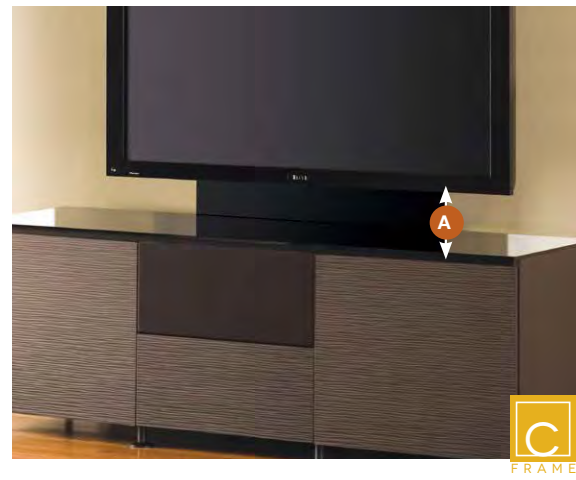

Chameleon Collection - FX100 TV Mounts

For Twin Cabinet, Black	CN/PM2/B
For Triple Cabinet, Black	CL/PM2/B
For Quad Cabinet, Black	CQ/PM2/B

* Clearance Below TV - A = 53.25 minus 1/2 of TV Height minus Cabinet Height (This assumes vertical brackets are centered on TV.)

- Black, panel measures 30"W x 16"H.
- Cannot be used with extended rear panels.

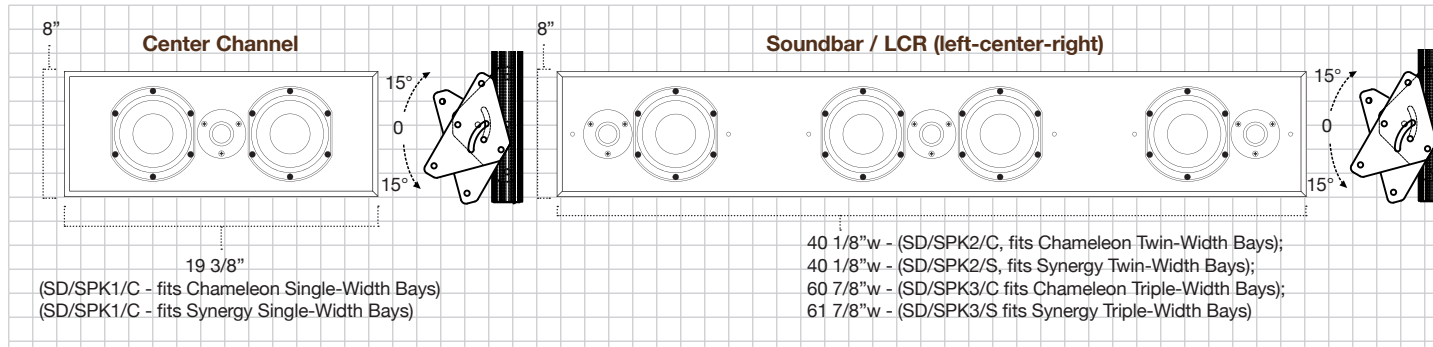

Components	5" midrange woofers; 1" audiophile-grade tweeters		Center Channel	LCR (left-center-right) Speaker
Model	SD/SPK1/C, SD/SPK1/S, SD/SPK2/C, SD/SPK2/S, SD/SPK3/C, SD/SPK3/S	Impedance	8Ω	6Ω
Height	8"	Rec. Power	50–250W	50–250W
Width	Varies, depending on model	Maximum Output	104 dB avg; 110 dB peak	101 dB avg; 107 dB peak
Depth	4"	Coverage	Hor: 110°; Vert: 140°	Hor: 110°; Vert: 140°
Material	Sealed MDF enclosure	Freq. Response	74–22kHz (+/- 3dB)	74–22kHz (+/- 3dB)
Weight	15–30 lbs (depending on configuration and width)	Sensitivity	88dB@2.83V/1m	88dB@2.83V/1m

Cabinets accommodate a range of speaker types and sizes. Salamander has partnered with Leon Speakers to offer custom-made premium soundbars to fit most of our cabinets. These center channel and LCR speakers are designed specifically to fit any single, twin or triple-wide speaker opening

- Custom built to seamlessly integrate with our Synergy and Chameleon AV cabinets
- Exclusive mounting brackets allow for articulation to optimize sound dispersion
- High-performance sound platform features world-class woofers and cloth-dome tweeters for exceptional sonic clarity
- Solid MDF construction, meticulously crafted by hand in the USA
- Cabinets accommodate center channel speakers Soundbars and subwoofers. Models: 229, 236, 245, 248, 329, 336, and 339.



In-Cabinet Center Channel

Single-Width (19 3/8") for Chameleon Collection	SD/SPK1/C
Single-Width (19 3/8") for Synergy System	SD/SPK1/S



In-Cabinet LCR Soundbar

Twin-Width (40 1/8") for Chameleon Collection	SD/SPK2/C
Twin-Width (40 1/8") for Synergy System	SD/SPK2/S
Triple-Width (60 7/8") for Chameleon Collection	SD/SPK3/C
Triple-Width (61 7/8") for Synergy System	SD/SPK3/S





Universal Storage Tray

Synergy Storage Tray, Black SA/UST

- Works well with laptops, tablets, personal media storage, gaming systems, cell phone charging station location, etc.
- Utilizes heavy duty ball bearing slides, black steel body with felt liner.
- Can be placed behind doors.
- Maximum Weight Capacity: 50 lbs
- Measures: 17.25" W x 16" D x 1.625" H with 3 locations to install 2 included dividers located at 4" 8.5" and 12.75" from the front edge.
- Compatible with Synergy System & Chameleon Cabinets



Media Trays

Synergy & Chameleon Media Tray 2, Black - Post Mounted	SA/UPT2
Chameleon Media Tray 2, Black - Bottom Mounted	CA/UPT

- Slotted to hold a selection of DVD's (75) and/or CD's (111) upright.
- Fits neatly behind a door.
- Metal construction, matte black finish.
- Interior Dimensions: 17.125"W x 15.875"D x 3.5"H
- CA/UPT are installed to the bottom shelf of a Chameleon cabinet (one per bay).
- Maximum Weight Capacity: 30 lbs
- Compatible with Synergy System & Chameleon Cabinets



Heavy Duty Pull-Out Shelf

Synergy & Chameleon, Black SA/PS2

- Full extension universal pull-out shelf
- Utilizes heavy duty ball bearing slides, 3/4" black MDF shelf
- Can be placed behind doors.
- Maximum Weight Capacity: 50 lbs
- Measures 18" w x 17.75" deep
- Compatible with Synergy System & Chameleon Cabinets



Synergy Drawer

Black	SA/MD/B
Cherry	SA/MD/C
Maple	SA/MD/M
Walnut	SA/MD/W

- **CANNOT BE PLACED BEHIND DOORS.**
- Interior Dimensions: 18.375"W x 6"H x 15.75"D
- Exterior Dimensions: 19.5"W x 6.75"H x 17.5"D
- Load Capacity: 100 lbs., 102 CD's or 52 DVD



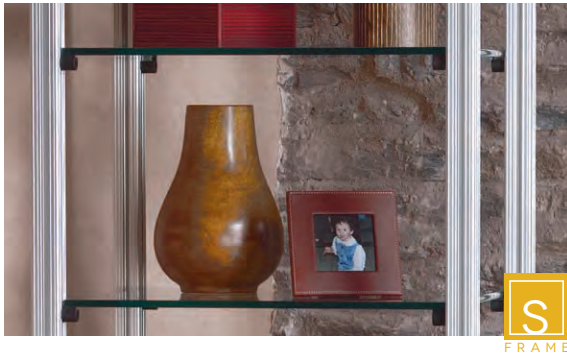

Synergy Tempered Glass Shelf

Standard Shelf, Clear Glass SA/G1

- Standard: Weight Capacity: 50 lbs.
- Measures: 19.75"W x 17.5"D x .375" TH.
- Constructed of 3/8" (10mm) clear tempered glass



Synergy Single-Width Shelf

Standard Shelf, Black SA/S1

- Standard: Weight Capacity: 75 lbs.
- Measures: 19.75"W x 17.5"D x .75" TH.
- Includes heavy-duty shelf brackets (150 lbs capacity).



Synergy Double-Width Shelf

Black Shelf with 8.5" Aluminum Post	SA/DS10/A
Black Shelf with 8.5" Black Post	SA/DS10/B

Black Shelf with 17.75" Aluminum Post	SA/DS20/A
Black Shelf with 17.75" Black Post	SA/DS20/B

Black Shelf with 27.75" Aluminum Post	SA/DS30/A
Black Shelf with 27.75" Black Post	SA/DS30/B

- Weight Capacity: 75 lbs.
- Inside Dimensions: 41"W x 17.5"D x 3/4
- Includes heavy-duty shelf brackets (150 lbs capacity).



Synergy Triple-Width Shelf

Black Shelf with 8.5" Aluminum Post	SA/TS10/A
Black Shelf with 8.5" Black Post	SA/TS10/B

Black Shelf with 17.75" Aluminum Post	SA/TS20/A
Black Shelf with 17.75" Black Post	SA/TS20/B

- Weight Capacity: 75 lbs.
- Inside Dimensions: 62.25"W x 17.5"D x 3/4



Chameleon In-Cabinet Refrigerator

Factory Installed X1/C-Frame 30 Refrigeration FI/C30/RGK/A

- Compatible with 317, 323, 329, 336, 337, 345, 347, 517 (top bay only) and 617.
- Built into a cabinet bay and hidden to create a first class refreshment center.
- 2.5 Cubic feet capacity.
- Factory Installed



LIGHT UP INTERIORS

See Accent Lighting Systems on page 104

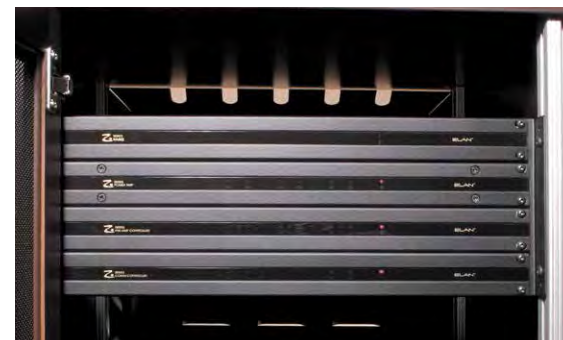

Pull-Out Rack Cartridge

7 U Cartridge for 20" Cabinets	CR7U/F
13 U Cartridge for 30" Cabinets	CR13U/F

- Integrates with cabinet frame and is easily removable for service.
- Compatible with Synergy and Chameleon cabinets.
- 19" rack with rails front and back of the rack 14" deep.
- Available in two standard heights: 7U configured to fit in a 20" height bay or in a 30" unit utilizing an upper speaker grill opening; 13U configured to fit within a 30" cabinet.
- Cabinet guide rails and in-line caster base provide simple use and transport.
- Tool-less removal / installation for service.
- Flexible cable management wire loom.
- Can be coupled with road cases for off-site service applications.
- Weight capacity 200 lb.
- Threaded for 10-32 screws.
- Rugged 12-gauge powder coated steel construction.

Post Mounted Rack Rail - Full Height

10 U Rails for Chameleon 20"H Cabinets	CA/DRM10U
15 U Rails for Chameleon 30"H Cabinets	CA/DRM15U
10 U Rails for Synergy 20"H Cabinets	SA/DRM10U
15 U Rails for Synergy 30"H Cabinets	SA/DRM15U
21 U Rails for Synergy 40"H Cabinets	SA/DRM21U

- Attaches to cabinet frame posts.
- Compatible with Synergy and Chameleon cabinets.
- Rack rails can be positioned for use with or without a door.
- Threaded for 10-32 screws.
- Includes two, black, powder coated rails per set.

Post Mounted Rack Rail - Component Height

1U Rails, 1.75"H	SA/RM1U
2U Rails, 3.5"H	SA/RM2U
3U Rails, 5.25"H	SA/RM3U
4U Rails, 7"H	SA/RM4U

- Attaches to front or rear cabinet posts.
- Compatible with Synergy and Chameleon cabinets.
- Doors can be used with component length rails, placed away from hinges.
- Allow for 1.5" clearance for each hinge.
- Includes two, black, powder coated rails per set. Threaded for 10-32 screws.

Rack Cartridge

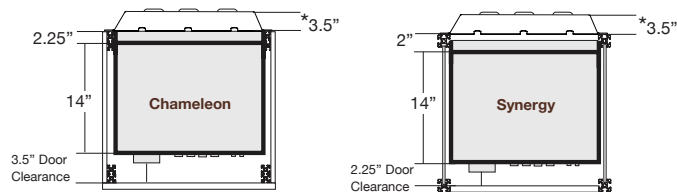

Synergy Post Mounted Rack Rails

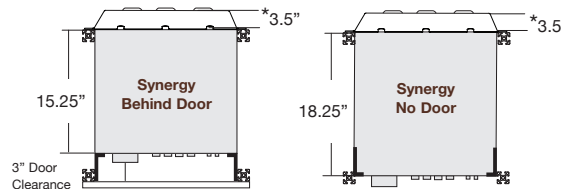

Chameleon Post Mounted Rack Rails

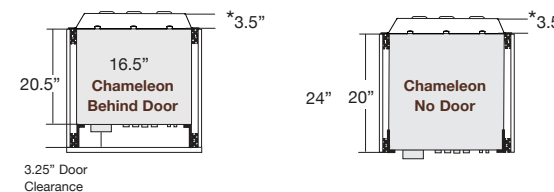

* When using optional Extended Rear Panel, see page 100.



Standard Rack Lacing Bars

Set of 2 RM/LB

- Mounts to Pull-Out Rack Cartridge and any 19" standard rack.
- Black powder coated steel.



Post Mounted Lacing Bar

Lacing Bar, Black - Set of 3 SA/RMLB

- Mounts to vertical cabinet posts.
- Infinitely adjustable wire management.
- Includes one velcro wrap strap.
- Compatible with Chameleon and Synergy cabinets.
- Black powder coated steel.



Rack Mount Vented Shelf

Vented Shelf - 2U	RM/VS/2U
Vented Shelf - 3U	RM/VS/3U
Vented Shelf - 4U	RM/VS/4U

- Mounts to Pull-Out Rack Cartridge and any 19" standard rack.
- 19" EIA standard rack mount, 14" deep, vented shelf.
- Black powder coated steel.
- Max weight capacity of 75lbs

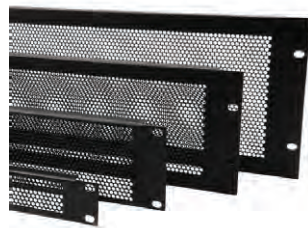

Rack Mount Face Plate

Vented Face Plate - 1U	RM/FP/1U
Vented Face Plate - 2U	RM/FP/2U
Vented Face Plate - 3U	RM/FP/3U
Vented Face Plate - 4U	RM/FP/4U

- Mounts to Pull-Out Rack Cartridge and any 19" standard rack.
- Features round perforated vent holes.
- Black powder coated perforated steel.



3U Vertical Rack Mount Bracket

3U Vertical Rack Mount Bracket, Wall or Post Fixing RM/VR/3U

- Mounts to vertical cabinet posts.
- 19" EIA standard rack mount.
- Black powder coated steel.
- See cabinet interior dimensions for usable space



Heavy Duty, Fine Floor Casters

Set of Four, Black	SA/HDC/4
Set of Six, Black	SA/HDC/6
Set of Eight, Black	SA/HDC/8
Set of Ten, Black	SA/HDC/10

- Adds 4" to height of cabinet.
- Capacity: 250 lbs. each wheel.
- Dual Wheel swivel casters with brakes.
- Compatible with Chameleon and Synergy cabinets.

Rack Mount Screws

10-32 x 3/4 Mounting Screws (100 Pack) SA/RM/S

- Button Head Cap screw, Black oxide finish.
- Uses 1/8" Allen socket wrench.
- Use with Pull-Out Rack Cartridge and any 19" standard rack.

ACTIVE COOLING & REAR PANELS



Chameleon Bottom In-Take Vent

Active Cooling - Bottom Vent SA/BVAC

- Designed for wall hanging cabinets & compatible with some floor standing cabinets, (clearance required: 2.5" from cabinet bottom to floor.)
- Forced air intake of cool air through cabinet bottom.
- Replaces standard cabinet bottom vent.
- Uses Thermal Trigger*



Chameleon Locking Rear Panels

Factory Installed, Chameleon 30 Locking Rear Panel	FI/C30/LRP
Factory Installed, Synergy 30 Locking Rear Panel	FI/S30/LRP

- Compatible with 317, 323, 336, 337, 345, 347, 517 (top bay only) and 617
- Sold separately.



Extended Rear Panels

17.75" Extended Rear Panel Black	SA/XR20
27.75" Extended Rear Panel, Black	SA/XR30
37.75" Extended Rear Panel, Black	SA/XR40

- Add 3.5 inches to cabinet depth - extended Chameleon cabinets to 23.5" and Synergy to 21.5".
- Compatible with Synergy System & Chameleon Cabinets
- **CANNOT BE USED IN CONJUNCTION WITH CHAMELEON TV MOUNTS**

Active Cooling Systems

Automatic, thermostatically controlled operation prevents heat build-up, protecting delicate electronics.



Chameleon Active Cooling Rear Panels

17.75" Panel, Black	CA/AC20
27.75" Panel, Black	CA/AC30

- Quiet (22 dBA) quad 120 mm fans exhaust warm air.
- Replace standard Chameleon rear panels.
- Includes Thermal Trigger*



*Thermal Trigger for All Active Cooling

- Aluminum back plate for mounting onto walls or cabinets.
- 6 foot water resistant thermal probe
- 4 Temperature settings (84°, 88°, 92°, 96°) plus one always on setting.



Chameleon Extended Rear Panels with Active Cooling

17.75" Active Cooling Panel, Black	SA/XR20/AC
27.75" Active Cooling Panel, Black	SA/XR30/AC

- Quiet (22 dBA) quad 120 mm fans exhaust warm air.
- Add 3.5 inches (23.5") inside depth to Chameleon cabinets.
- Includes Thermal Trigger*
- **CANNOT BE USED IN CONJUNCTION WITH CHAMELEON TV MOUNTS**



Synergy System Extended Rear Panels with Active Cooling

17.75" Active Cooling Panel, Black	SA/XR20/AC
27.75" Active Cooling Panel, Black	SA/XR30/AC
37.75" Active Cooling Panel, Black	SA/XR40/AC

- Quiet (22 dBA) quad 120 mm fans exhaust warm air.
- Add 3.5 inches (21.5") inside depth to Synergy cabinets.
- Includes Thermal Trigger*



Power Conditioner Kit

Power Conditioner with Bracket	CA/PCK	119
Mounting Bracket for Chameleon & Synergy Cabinets	CA/PCM	24

- Filters AC current to deliver better quality sound and picture.
- Panamax Model # M8AV.
- 8 AC outlets, 2 CATV connectors, 2 pair of satellite connectors, in/out telco connectors with phone line splitter, 8' power cord, accepts add-on signal line modules.
- Bracket Measures: 12"W x 5"H x .125"TH
- Mounts to cabinet interior or exterior.
- Compatible with Synergy System & Chameleon Cabinets



Power Distribution Unit

1-U Rack Mounted Power Distribution Unit	SA/RM/PDU
--	-----------

- Requires Rack Rails, see Page 98.
- 8 Filtered & Protected Outlets (Rear) + 1 Front Panel Convenience Outlet
- Power Distribution Unit with surge protection
- Maximum Output Current: 15 Amps
- Line Cords: 6 ft. captive, 14 AWG, with 3-conductor Edison Plug
- Operating Voltage: 120VAC 60Hz
- Spike Protection Mode: Line to neutral
- Energy Dissipation: 170 Joules
- Peak Impulse Current: 12,000 Amps
- Maximum Continuous Operating Voltage: 130 VAC RMS
- Let Through Voltage (@ 125 amps, 8/20uS waveform): 400 volts
- Noise Attenuation (Transverse Mode): Greater than 23db, 200Khz to 10MHz
- Dimensions: 1.75" H x 19" W x 3.75" D
- Weight: 4.9 lbs. (2.2 kg)
- Safety Agency Listing: cTUVus
- Three Year Limited Warranty: Covering defects in materials and workmanship
- Compatible with Synergy System & Chameleon Cabinets



Chameleon Power & USB Ports

Factory Installed 1 AC Power Outlet, 2 USB - Black	FI/PWR/USB
Factory Installed 2 AC Power Outlet - Black	FI/PWR/AC

- Can be installed on any Chameleon cabinet.
 - USB Power Rating: 5V DC/CC 700mA
 - Cable is pre-wired and requires no electrical wiring by the installer
 - ETL listed, UL Rated 817D, CSA STD 22.2 42.1-00
- | | |
|---|---|
| <ul style="list-style-type: none"> • Receptacle - UL Listed Receptacle 351B - ETL Listed Assembly - Tamper Resistant - Power Rating: 15A-125V | <ul style="list-style-type: none"> • USB - Easily charge cell phones/ MP3 player - Save space-no adapter required - USB Power Rating: 5V DC/CC 700mA - Indicator light confirms charging status |
|---|---|
- Includes 3ft. Pre-wired Power Cord and Décor Wall Plate



Saturn Wheels

Satin Black, Set of 4	SA/C/4/BK
Satin Black, Set of 6	SA/C/6/BK
Satin Black, Set of 8	SA/C/8/BK
Satin Black, Set of 10	SA/C/10/BK

Satin Chrome, Set of 4	SA/C/4
Satin Chrome, Set of 6	SA/C/6
Satin Chrome, Set of 8	SA/C/8
Satin Chrome, Set of 10	SA/C/10

- Adds 3" to height of cabinet.
- Capacity: 100 lbs. each wheel.
- Wheels rotate 360° and include brake.
- Metal wheel with non-marking rubber ring.



Heavy Duty Casters

Set of 4, Black	SA/HDC/4
Set of 6, Black	SA/HDC/6
Set of 8, Black	SA/HDC/8
Set of 10, Black	SA/HDC/10

- Adds 4" to height of cabinet.
- Capacity: 250 lbs. each wheel.
- Dual Wheel swivel casters with brakes.



Chameleon Tapered Wood Feet

Set of 4, Black	CA/BF/4/BK
Set of 5, Black	CA/BF/5/BK
Set of 6, Black	CA/BF/6/BK

- Adds 3.25" to height of cabinet.
- Solid hardwood with adjustable levelers.
- Capacity: 125 lbs. each foot.



Chameleon Low Profile Wood Feet

Set of 4, Espresso	CA/BF2/4/E
Set of 5, Espresso	CA/BF2/5/E
Set of 6, Espresso	CA/BF2/6/E
Set of 4, Black	CA/BF2/4/B
Set of 5, Black	CA/BF2/5/B
Set of 6, Black	CA/BF2/6/B

- Adds 1.25" to height of cabinet.
- Solid hardwood with adjustable levelers.
- Capacity: 125 lbs. each foot.



Stiletto Feet

Matte Black, Set of 4	SA/SFB/4
Matte Black, Set of 6	SA/SFB/6
Matte Black, Set of 8	SA/SFB/8

Matte Silver, Set of 4	SA/SFA/4
Matte Silver, Set of 6	SA/SFA/6
Matte Silver, Set of 8	SA/SFA/8

- Adds 6" to height of cabinet.
- Capacity: 150 lbs. each foot.
- Machined anodized aluminum.



Claw Feet

Set of 4, Polished Aluminum	SA/AF/4
Set of 6, Polished Aluminum	SA/AF/6
Set of 8, Polished Aluminum	SA/AF/8

- Adds 3" to height of cabinet.
- Capacity: 150 lbs. each foot.
- Hand polished cast aluminum.



Robot Feet

Set of 4, Black	SA/RFB/4
Set of 6, Black	SA/RFB/6
Set of 8, Black	SA/RFB/8

- Adds 3" to height of cabinet.
- Capacity: 150 lbs. each foot.
- Machined anodized aluminum.



Chameleon Steel Tube Core

For Twin Cabinets, Matte Black	CA/TB/N/B
For Triple Cabinets, Matte Black	CA/TB/L/B
For Quad Cabinets, Matte Black	CA/TB/Q/B

- Adds 5" to height of cabinet.
- Features adjustable levelers.
- Capacity: 600 lbs.
- Powder-coated welded steel tube.

Decorator Feet and Wheels fine-tune the style and function. We offer a variety of cabinet feet and casters to replace standard cabinet feet.

ORDERING FOOTING

Chameleon Single-Width	Set of 4
Chameleon Twin-Width	Set of 4
Chameleon Triple-Width	Set of 8
Chameleon Quad-Width	Set of 6
Synergy Single-Width	Set of 4
Synergy Twin-Width	Set of 6
Synergy Triple-Width	Set of 8
Synergy Quad-Width	Set of 10



• **Wheels, Feet, & Bases are NOT compatible with Barcelona and Corsica styles.**



Leveler Feet

Set of 4, Black	CA/LF/4
-----------------	---------

- Adds 1.25 - 1.75" to height.
- Capacity: 150 lbs. each foot.
- Steel with polyethylene pad.



Chameleon Wall Mounting Kits

For Single 217 Cabinets	CU/WK1
For Twin 221 Cabinets	CN/WK1
For Triple 236 & 237 Cabinets	CL/WK1
For Quad 247 & 245 Cabinets	CQ/WK1

- Simple DIY Installation mounts to wood or masonry wall construction.
- Replaces standard feet and allows cabinet to hang from wall.
- Powder-coated steel brackets.

! Not compatible with 30" Cabinets or Barcelona & Corsica styles.

Synergy Wall Mounting Kits

For Single 217 Cabinets	SU/WK1
For Twin 221 Cabinets	SN/WK1
For Triple 132, 133, 236 & 237 Cabinets	SL/WK1
For Quad 147 & 247 Cabinets	SQ/WK1

- Simple DIY Installation mounts to wood or masonry wall construction.
- Replaces standard feet and allows cabinet to hang from wall.
- Powder-coated steel brackets.

Compatible Models



217

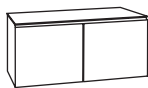

221

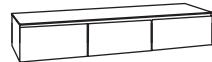

132 & 133

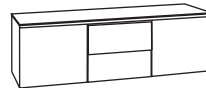

236

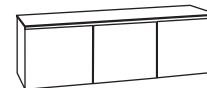

237

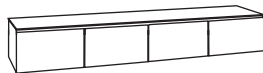

147

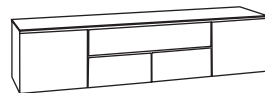

245

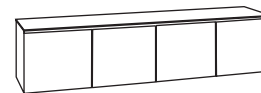

247

Wall hanging cabinets are the ultimate way to create the look of custom cabinetry, with the illusion that your cabinet is floating above the floor. Best of all, installation is simple. Just remove the standard cabinet feet, install the specialized wall hanging brackets and presto!

- Powder-coated steel brackets.
- Replaces standard feet and allows cabinet to hang from wall.
- Simple DIY Installation mounts to wood or masonry wall construction.



Load Capacity

Models	Equipment Load Capacity
CU/WK1 & SU/WK1	50 lbs.
CN/WK1 & SN/WK1	50 lbs.
CL/WK1 & SL/WK1	150 lbs.
CQ/WK1 & SQ/WK1	200 lbs.



LIGHTING, IR REPEATERS & SECURITY LOCKS



Accent Lighting System

Lighting System with Two 15" Bars SD/LS2/W

- Adjustable Color Temperature: Cool to Warm 3200-6500K
- Expandable hub for up to 4 additional LED light bars
- 15" & 24" LED light bars also available
- Full dimming and brightness control
- Breath and sleep modes
- Infrared remote control
- Up to 3 memory settings
- Compatible with Synergy System & Chameleon Cabinets

Lighting Expansion

15" Light Bar Expansion Kit SD/LSX15/W

24" Light Bar Expansion Kit SD/LSX24/W



All In One IR Repeater

IR Repeater Kit SD/IR

- Allows Infrared remote to control electronics behind closed wooden doors
- Complete kit includes; 2 plugs / 4 IR Emitters, wire management accessory, power supply and mounting hardware for Chameleon, Synergy and other wood cabinets



IR Flasher, Dual-Head Emitter

Black SD/IRX2

- Increases the capacity of the SD/IR by splitting two emitters from one plug



Chameleon Locking Rear Panels

Factory Installed Chameleon 30 Locking Rear Panel FI/C30/LRP

- Compatible with 317, 323, 329, 336, 337, 345, 347, 517 (top bay only) and 617
- Sold separately

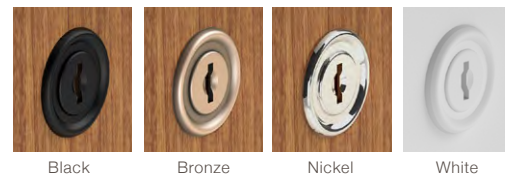

Door Locks

Factory Installed Chameleon Door Lock- Black	FI/C/DL/BK
Factory Installed Chameleon Door Lock- Bronze	FI/C/DL/BZ
Factory Installed Chameleon Door Lock- Nickel	FI/C/DL/NK
Factory Installed Chameleon Door Lock- White	FI/C/DL/WH
Factory Installed Synergy Door Lock - Black/Nickel	FI/SD/LOCK
DIY Synergy Door Lock Kit - Black/Nickel	SD/LOCK

- Locks CANNOT be added to Glass front doors.

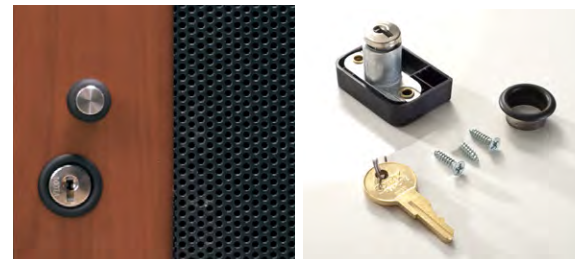

DIY Synergy Door Lock Kit (SD/LOCK)

SADDLE

IPAD HOLDER



The innovative iPad Bean Bag Stand features a convenient mounting interface. The handmade, real leather bag easily conforms to any flat or irregular surface to provide a leveled viewing angle.

- Luxurious / Premium handmade leather bean bag
- Soft and non-marring so it's great for kids and furniture
- Stable in any position on virtually any surface
- Filled with eco-friendly, recycled pellets
- Visit SalamanderDesigns.com for the latest models and compatibility.



Creme Pearl
TS1/L/CM



Charcoal Pearl
TS1/L/CL



Graphite
TS1/L/GT



Mushroom
TS1/L/MR



Parquet
TS1/L/PQ



Red
TS1/L/RD



Creme/Charcoal
TS1/L/CMCL



Parquet / Mushroom
TS1/L/PQMR



Red/Graphite
TS1/L/RDGT

CUSTOM SEATING

Entertainment seating is one of the most critical elements of a media room. That is why every piece of Salamander seating is constructed with the highest degree of strength, style and comfort. Our seating collections reflect a love of modern design, with simple, refined lines and functional forms. Salamander's advanced, flexible seating solutions more than measure up.

Our bench made home theater seating is **hand built & shipped in 30 business days**, enabling you to enjoy your furniture sooner than later.



BUILT TO LAST

RELAX...IT'S BUILT TO LAST

Our unique suspension system provides comfort and long-lasting support. It combines traditional springs and modern elastic webbing with the highest quality resilient virgin polyurethane foam. Cushions are cut to shape, wrapped with a layer of memory foam and covered with a layer of polyester padding before covering. This prevents cushions from packing down and losing their shape over time.

Seating frames are constructed of top-grade plywood that flexes and recovers without cracking. Joints are crafted with mortise-and-tenon construction for greater strength and durability. Only American-made, commercial-grade mechanisms are used, and higher gauge steel assures exceptional durability and reliability. Powered chairs have quiet motorized controls and infinitely variable stops to find the perfect position. No shortcuts...no compromises.

The key to seating ergonomics is to have the right support in the right place. Watching a movie can be an hours long experience, so proper support is essential.



DESIGN YOUR OWN



THE PERFECT SEATING SOLUTION

The innovative modular design of all Salamander seating styles means your options are endless.

Suit your space, taste and needs to enhance the comfort and enjoyment of your home theater experience in just a few steps.

Custom design your home theater room with our user-friendly DESIGN YOUR OWN configurator,

SalamanderDesigns.com/DYO.

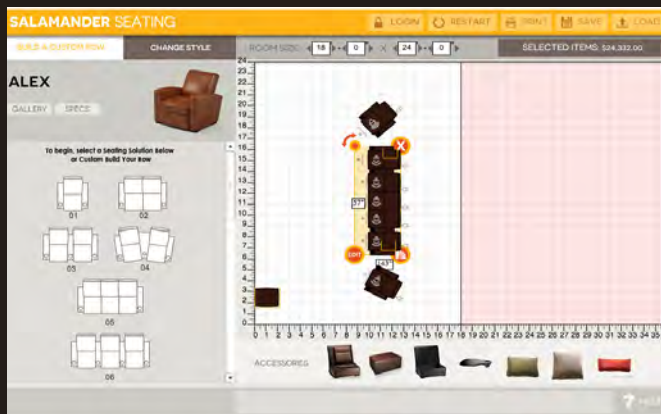

STYLE

Choose yours.

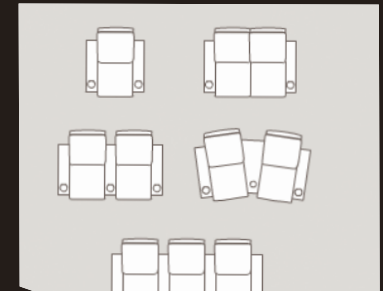

MODULAR

Configure loveseats, straight or curved rows of seating by combining chair modules.



MECHANISM

Opt for a quiet powered or manual mechanism and recline in ultimate comfort.

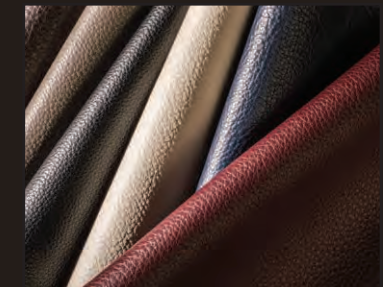

COVERS

Select from a wide selection of premium leathers and durable fabrics with stitching options.



Supply Your Own
Cover Material
Call for Details

PREMIUM SEATING MATERIALS

Choose the Salamander Seating material that fits your style, room and lifestyle like a glove. Our durable, premium, top grain leathers and fabrics are intensely pleasing to the eye and touch.

Go to SalamanderDesigns.com to request swatch samples.

CUSTOM DETAILS



CONTRAST PIPING

Perfect for creating a refined, sophisticated and personalized look. Available on some styles (color combinations must be within the same leather group).

CONTRAST STITCHING

Accentuate the fine detail on your custom handmade seating. Available on some styles (ivory or gray stitch, dependant on color selected).



SURFACE

Swivel tablets easily install into cup holders to provide handy surfaces.



PILLOWS

Matching lumbar pillows provide additional support, available in any leather or Microsuede.



CUP HOLDER

Recessed, with option for black or silver anodized aluminum. 2-7/8 Diameter



VIBRATION

Experience the natural percussive impact of movie sounds with Sound Transducers that produce a full range of frequency vibrations.

PREMIUM LEATHER LUSTRA

Full hides of supple, top-grain steer leather are carefully selected, dyed and top coated for added protection. Lustra's soft hand and classic character are reminiscent of Old English bridle.

PREMIUM LEATHER ROYAL

Fine Italian, aniline dyed leather with a soft and supple hand. Fine graining enhances Royal's beauty and gives it a warm, cozy appeal.



PREMIUM LEATHER

VINTAGE

Full-grain, aniline-dyed steer hides are selected for an excellent soft hand and drape. The age-distressed look, natural markings and color variants give each Vintage chair a unique, authentically rustic look.

PREMIUM LEATHER

LUXE

American dairy cowhide is meticulously selected for a natural, even, pebbled grain. Luxurious looking with excellent durability, Luxe is recommended for the contract, hospitality and residential markets.

Acorn

Bark

Hazelnut

Oatmeal

Pewter

Oyster

Adirondack

Merlot

Mushroom

Go to SalamanderDesigns.com
to request swatch samples.

Onyx

Mariner

Alabaster

TOP GRAIN LEATHER EARTH

Ultra-supple, top-grain cowhide with excellent durability, deep color and incredibly soft touch. Easy to clean, Earth leathers are an ideal choice for families with children or pets. Available in a range of colors.

Snow
(Piping Only)

Canyon

Chocolate

Redrock

Desert

Sand

Terrain

Stout

Cabernet

Eclipse

Ruby

Limestone

Charcoal

Pistachio

Fog

Anchor

FABRIC SERENE

Serene offers the best of all worlds a soft to the touch, durable fabric that drapes well and wears even better. 100% Polyester, Serene is an easily cleaned seating material that has the wear resistance you'll appreciate. Competitively priced and available in a wide range of stylish, on trend colors, Serene is one of our customers favorite textile seating materials.

FABRIC

VELUTO

Soft to the touch, like modern day velvet. Reminiscent of old time theaters, Veluto takes a classic style and amps it up with a contemporary look and feel for a perfect blend of comfort and style.

Veluto only available for Olivia and Jumpseat

FABRIC

MICROSUEDE

Exceptional value, attractive looks and growing in popularity. This 100% Micro denier fabric's soft feel, smooth nap, durability and easy cleaning make it an ideal choice for today's busy lifestyles.

Slate

Root Beer

Flax

Mocha

Espresso

Stone

Moss

Putty

Go to SalamanderDesigns.com
to request swatch samples.

Brandy

Black

Sage



Royal Iron Gate with Contrasting Stitch



DIAMOND PATTERN

LUCA

With its distinctly European style, Luca features transitional design with **diamond-shaped pattern** and double-needle stitching. Elegant, roomy, and comfortable, Luca Theater Seating is perfect for your home theater.



MODULES

End chairs combine with chair connectors or armless chairs for straight or wedge shaped rows.
Two armless Luca modules can be joined without arm connectors.

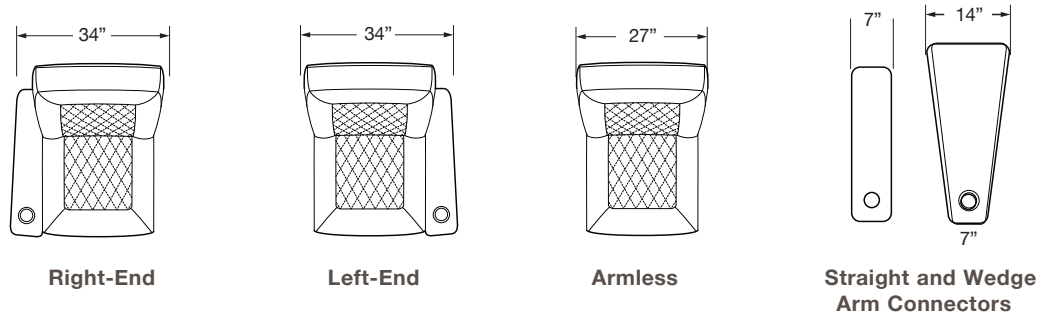

SPECIFICATIONS

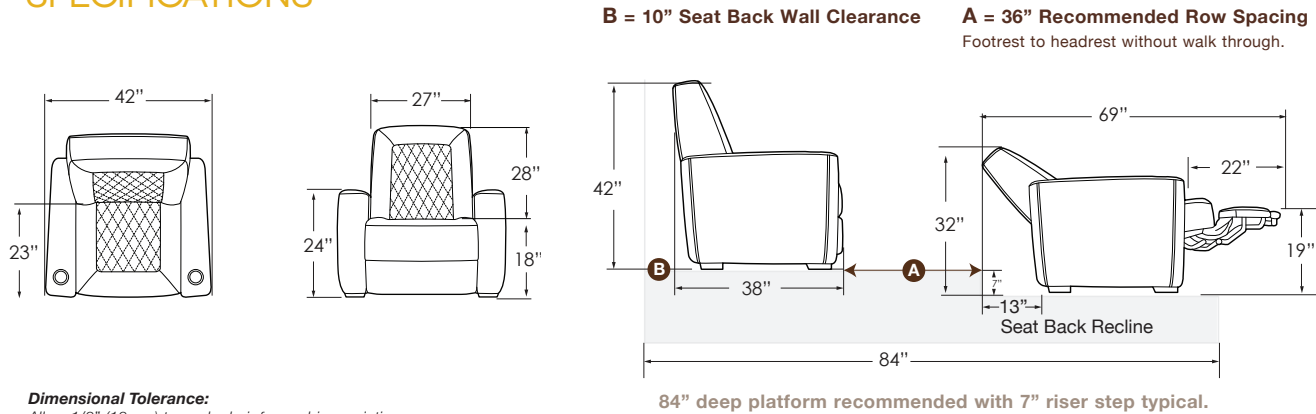

Dimensional Tolerance:
Allow 1/2" (12mm) to each chair for cushion variation.

MODULAR SOLUTIONS

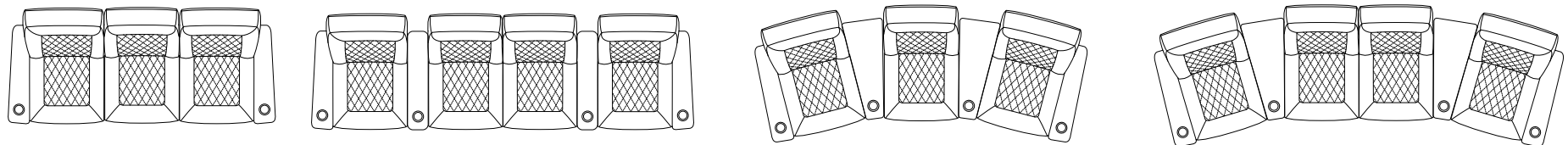

- Wall-away recliner mechanism allows close-to-wall positioning
- Fully-adjustable, motorized* recliner or 3-position manual recliner mechanism
- Leather or microsuede covers
- Tailored, optional contrast double needle stitch
- Black, silver or no cup holder

* Power Mechanism Electrical Specifications: 110 V AC, 2.0 amps nominal load, 5.0 amps max load, thermally protected



Design & Quote Custom Theater Seating Online with our **Custom Configurator**
SalamanderDesigns.com



HORIZONTAL PATTERN

LILLIANA

Large and comfortable, Lilliana theater seating combines transitional style with a distinctive retro flair. Lilliana theater seating -- with generous cushioning and large arms -- invites you to be seated in lavish comfort.



MODULES

End chairs combine with chair connectors or armless chairs for straight or wedge shaped rows.
Two armless Lilliana modules can be joined without arm connectors.

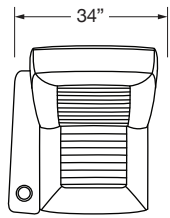

Right-End

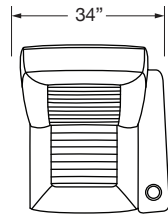

Left-End

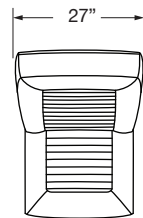

Armless

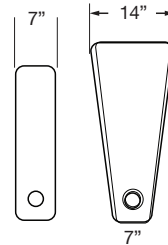

Straight and Wedge
Arm Connectors

SPECIFICATIONS

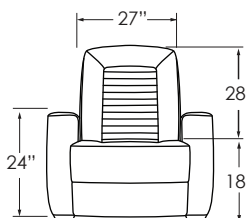
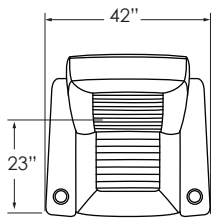

B = 10" Seat Back Wall Clearance

A = 36" Recommended Row Spacing
Footrest to headrest without walk through.

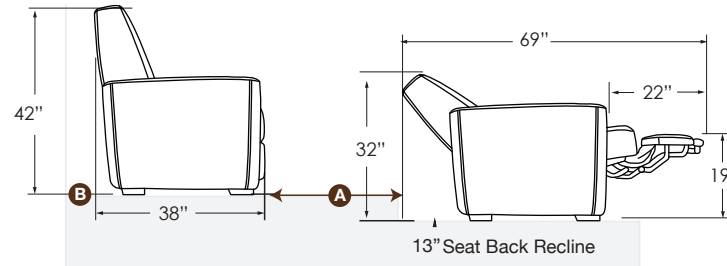

84" deep platform recommended with 7" riser step typical.

Dimensional Tolerance:

Allow 1/2" (12mm) to each chair for cushion variation.

MODULAR SOLUTIONS

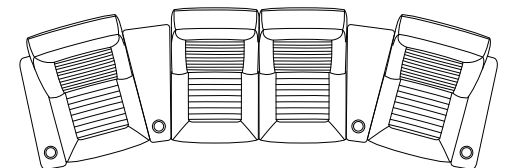
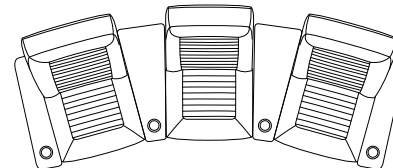
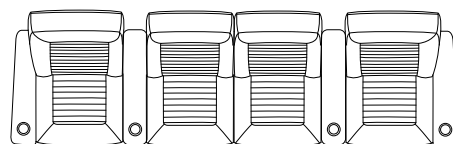
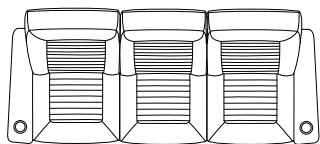

- Wall-away recliner mechanism allows close-to-wall positioning
- Fully-adjustable, motorized* recliner or 3-position manual recliner mechanism
- Leather or Microsuede covers
- Tailored, piping with optional contrast piping
- Black, silver or no cup holder

* Power Mechanism Electrical Specifications: 110 V AC, 2.0 amps nominal load, 5.0 amps max load, thermally protected



Design & Quote Custom
Theater Seating Online with
our **Custom Configurator**
SalamanderDesigns.com



Foyal Cognac with Cashmere Piping

ISABELLA

Heads turn when Isabella's in the room. Updated, traditional style with fine tailoring and subtle curves beckon from all angles. Obsessive attention to detail shows in the precise stitching, tailored piping, handsome roll arms and advanced ergonomics.



MODULES

End chairs combine with chair connectors or armless chairs for straight or wedge shaped rows.
Two armless Isabella modules can be joined without arm connectors.

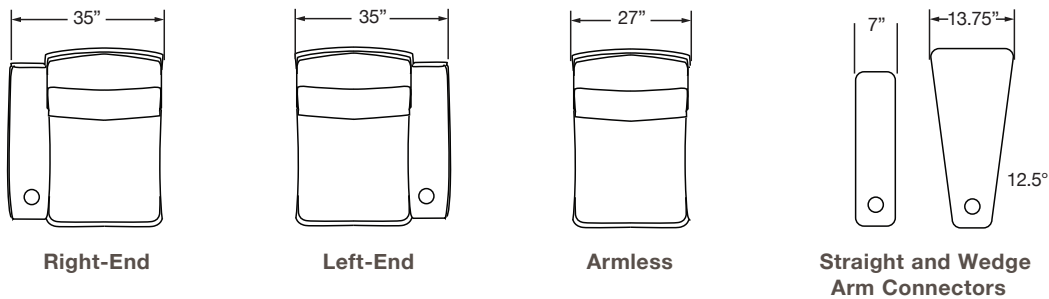

SPECIFICATIONS

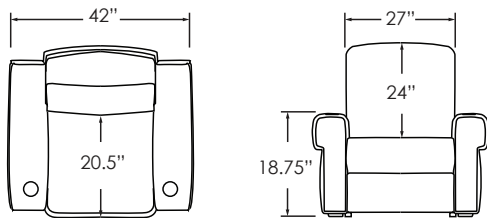

B = 10" Seat Back Wall Clearance **A = 36" Recommended Row Spacing**
Footrest to headrest without walk through.

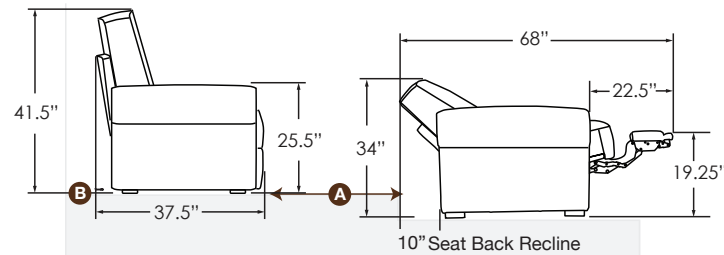

83.5" deep platform recommended with 7" riser step typical.

Dimensional Tolerance:
Allow 1/2" (12mm) to each chair for cushion variation.

MODULAR SOLUTIONS



- Wall-away recliner mechanism allows close-to-wall positioning
- Fully-adjustable, motorized* recliner or 3-position manual recliner or non-reclining mechanism
- Leather or Microsuede covers
- Tailored, piping with optional contrast piping
- Black, silver or no cup holder

* Power Mechanism Electrical Specifications: 110 V AC, 2.0 amps nominal load, 5.0 amps max load, thermally protected



Design & Quote Custom Theater Seating Online with our **Custom Configurator**
SalamanderDesigns.com



Chocolate Earth and Putty Microsuede

OLIVIA

More than the ideal choice for a dedicated home theater, Olivia is perfect for today's media room, family room or great room. Chaise and corner connectors easily create cozy "L"-shaped sectionals while straight connector arms allow typical theater rows. Stylish two-tone covers provide even greater design personalization.



MODULES

End chair, chaise or corner modules combine with chair connectors or armless chairs for straight rows or sectionals.
Two armless or chaise Olivia modules can be joined without arm connectors.

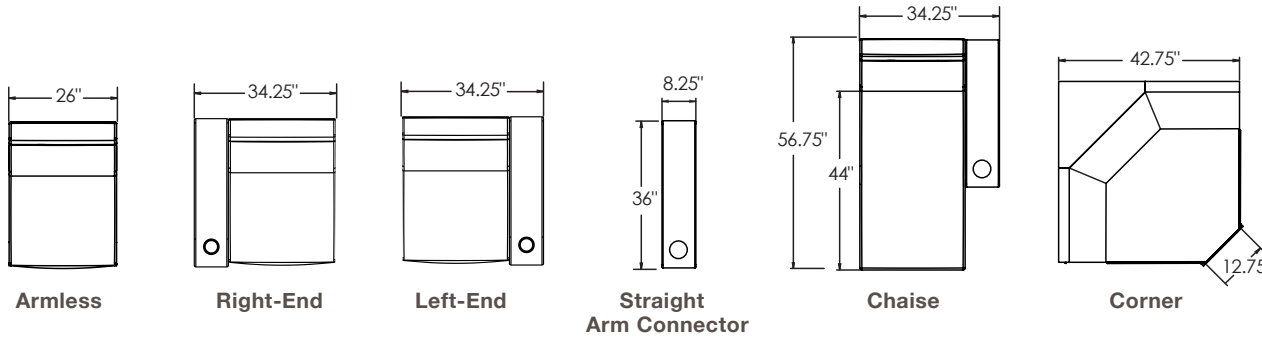

SPECIFICATIONS

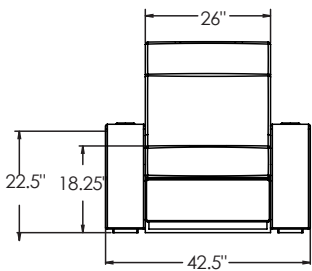

Dimensional Tolerance:
Allow 1/2" (12mm) to each chair for cushion variation.

B = 4" Seat Back Wall Clearance

A = 37" Recommended Row Spacing
Footrest to headrest without walk through.

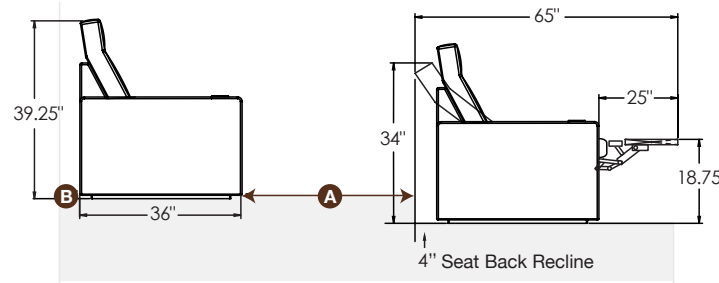

77" deep platform recommended with 7" riser step typical.

MODULAR SOLUTIONS

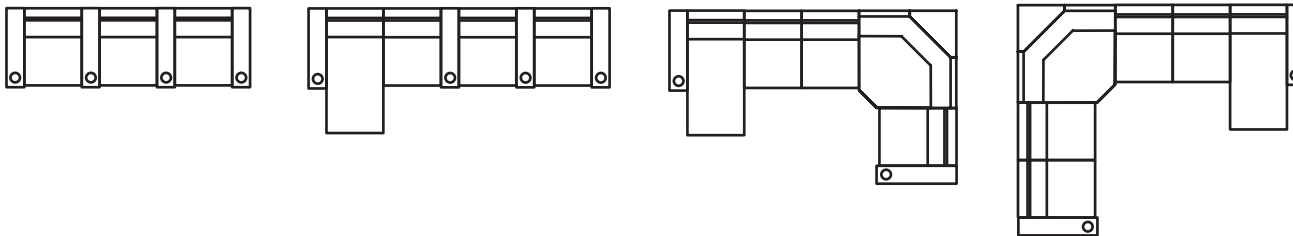

- Wall-away recliner mechanism allows close-to-wall positioning
- Fully-adjustable, motorized* recliner or 3-position manual recliner or non-reclining mechanism
- Corner section is non-reclining and includes 3 loose pillows
- Chaise section is non-reclining
- Personalize by choosing between stylish two-tone leather & Veluto fabric seats or full fabric in Veluto or Serene.
- Tailored, double-needle stitch with optional contrast stitching
- Black, silver or no cup holder

* Power Mechanism Electrical Specifications: 110 V AC, 2.0 amps nominal load, 5.0 amps max load, thermally protected



Design & Quote Custom Theater Seating Online with our **Custom Configurator**
SalamanderDesigns.com

Now available in full fabric
Choose from Veluto or Serene



TALIA

Generous cushioning and graceful, Modern-inspired curves invite you to be seated while the reclining back and hidden footrest support you in lavish comfort.



MODULES

End chairs combine with chair connectors or armless chairs for straight or wedge shaped rows.
Two armless Talia modules can be joined without arm connectors.

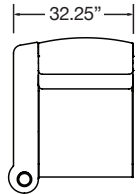

Right-End

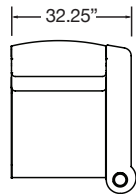

Left-End

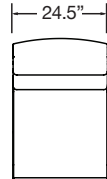

Armless

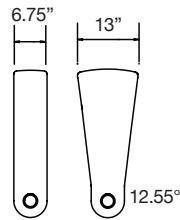

Straight & Wedge
Arm Connectors

SPECIFICATIONS

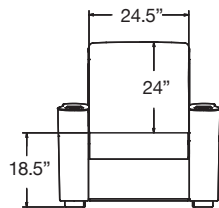
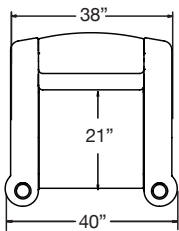

B = 3" Seat Back Wall Clearance **A = 36" Recommended Row Spacing**
Footrest to headrest without walk through.
(Measured with chair in upright position)

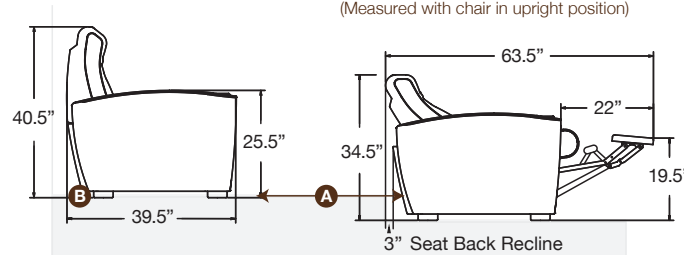

78.5" deep platform recommended with 7" riser step typical.

Dimensional Tolerance:
Allow 1/2" (12mm) to each chair for cushion variation.

- Wall-away recliner mechanism allows close-to-wall positioning
- Fully-adjustable, motorized* recliner or 3-position manual recliner or non-reclining mechanism
- Leather, Serene, or Microsuede covers
- Tailored, piping with optional contrast piping
- Black, silver or no cup holder

* Power Mechanism Electrical Specifications: 110 V AC, 2.0 amps nominal load, 5.0 amps max load, thermally protected



Design & Quote Custom
Theater Seating Online with our
Custom Configurator
SalamanderDesigns.com

MODULAR SOLUTIONS

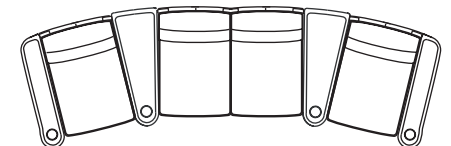
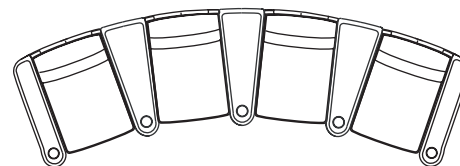
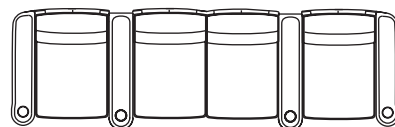
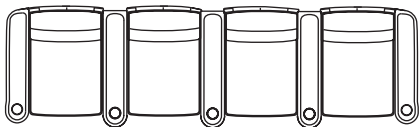



MATTEO

Matteo provides the comfort of a large, embracing chair on a relatively small footprint. This is a great benefit in applications where a large number of seats must fit into a limited space.



MODULES

End chairs combine with chair connectors or armless chairs for straight or wedge shaped rows.
Two armless Matteo modules can be joined without arm connectors.

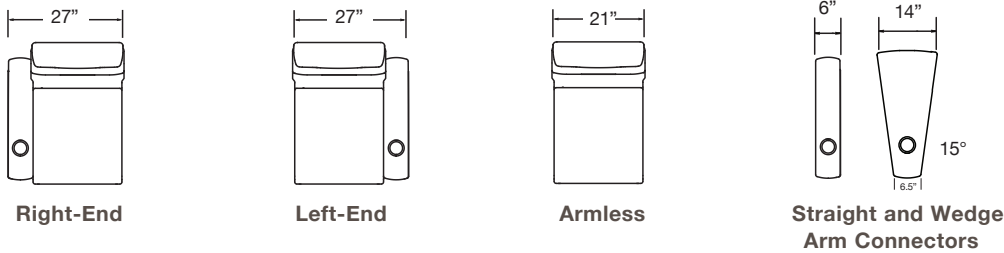

SPECIFICATIONS

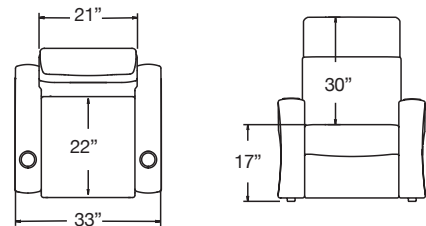

B = 24" Seat Back Wall Clearance

A = 44" Recommended Row Spacing
Footrest to headrest without walk through.

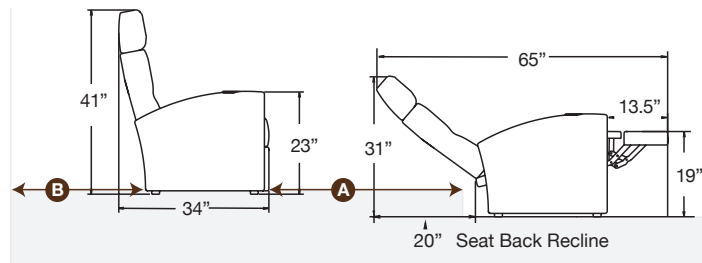

98" deep platform recommended with 7" riser step typical.

Dimensional Tolerance:
Allow 1/2" (12mm) to each chair for cushion variation.

- Small footprint with premium comfort
- Adjustable headrest for just-right support
- Fully-adjustable, motorized* recliner or 3-position manual recliner or push on arm non-reclining recliner
- Leather, Serene, or Microsuede covers
- Tailored, double-needle stitch with optional contrast stitching
- Black, silver or no cup holder

* Power Mechanism Electrical Specifications: 110 V AC, 2.0 amps nominal load, 5.0 amps max load, thermally protected



Design & Quote Custom Theater Seating Online with our Custom Configurator
SalamanderDesigns.com

MODULAR SOLUTIONS





Earth - Ruby Leather

Hazelnut - Vintage Leather

ALEX

Inspired by the classic club chair, the Alex's swooping arms and low-slung profile give it a sensuous style with timeless appeal. It's low seat back enables a full surround sound experience, making this the perfect audiophile listening chair. A unique incline mechanism provides elevated leg support, while maintaining an upright seat back position. This thoughtful design ensures a heightened sensory experience.



MODULES

End chairs combine with chair connectors or armless chairs for straight or wedge shaped rows.
Two armless Alex modules can be joined without arm connectors.

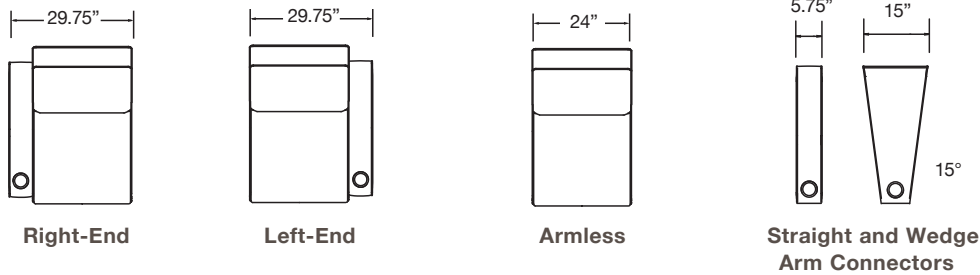

SPECIFICATIONS

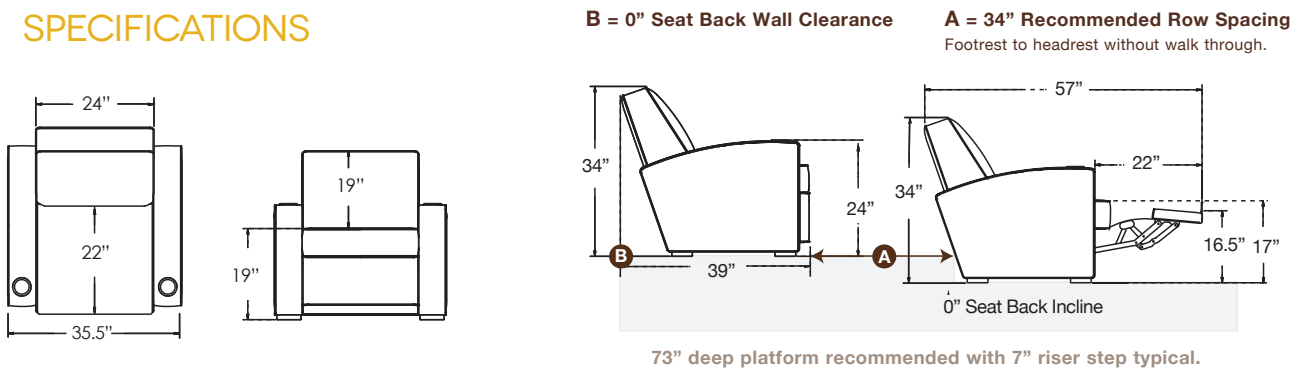

Dimensional Tolerance:
Allow 1/2" (12mm) to each chair for cushion variation.

MODULAR SOLUTIONS

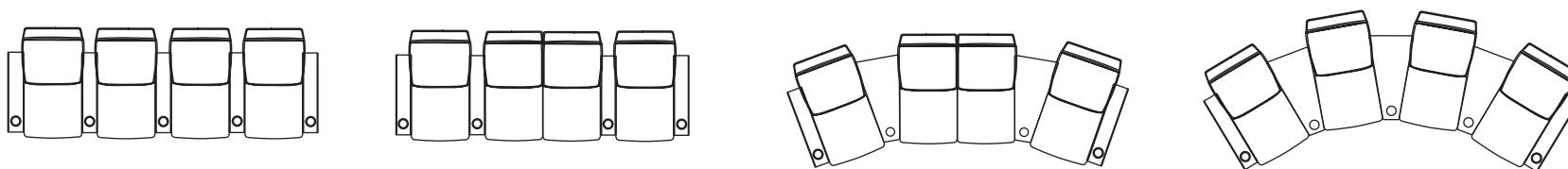

- Wall-away incline manual or powered mechanism* provides elevated leg support, while maintaining an upright seat back position
- Leather, Serene, or Microsuede covers
- Tailored, piping with optional contrast piping
- Black, silver or no cup holder

* Power Mechanism Electrical Specifications: 110 V AC, 2.0 amps nominal load, 5.0 amps max load, thermally protected



Design & Quote Custom Theater Seating Online with our Custom Configurator
SalamanderDesigns.com



OTTOMANS, TABLES, PILLOWS & MORE



Custom Jumpseat Ottoman

- One minute it's an ottoman, but open it up and it becomes a comfortable, fully cushioned seat with storage compartment.
- Customize with your choice of leather or Veluto exterior with a Veluto interior seat with or without silver or black cupholders.
- Seat measures: 22"W x 17"D

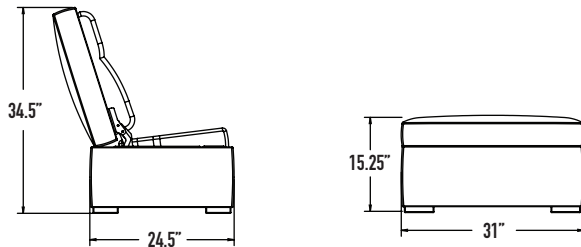

Custom and Standard Jumpseat Specifications.



Clark Synthesis Tactile Sound Transducer

Clark Synthesis #239, Black

TST239

- Requires an amplifier.
- Produces a full range of frequency vibrations, allowing you to experience the natural percussive impact of movie sounds.
- Simple installation, mounting stud pre installed in seat.
- 8" in diameter.
- Continuous Power Handling: 100 watts, Impedance: 4 ohms, Overload Protection: Polyswitch, Frequency Response: 15Hz to 17kHz
- Recommended amp 150 - 250 watts



Storage Ottoman

- One minute it's an ottoman, but open it up and it becomes a roomy storage container.
- Dark Gray Interior
- Interior Storage Measures: 24.5"W x 20.5"D

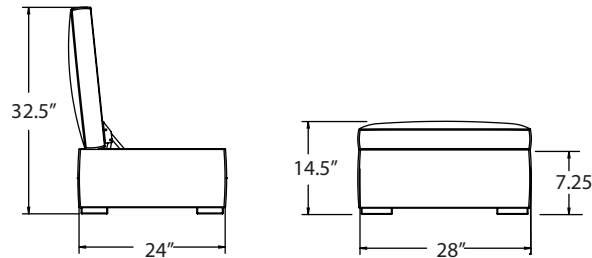

Cache End-Table

- Dark Gray Interior
- Dark Walnut Wood Veneer Top with Leather Pull
- Dark Solid wood feet

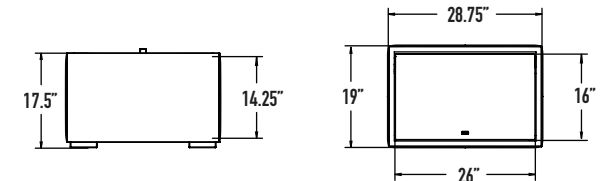

Swivel Tablet

Black

STB/B

- Removable tablet that simply installs into any cup holder to serve as a personal surface.
- Measures 20"W x 12.5"D x .75"TH.
- Capacity of 7 lbs.
- Not compatible with AV Basics Seating



Powered Chair Battery Pack

Battery Pack

BP1

- 24 Volt Nickel-metal hydride rechargeable battery
- Enables powered chairs to be used in areas without outlets
- 200 Open / Close cycles

Lumbar Pillows

- Pillow One Measures 22"W x 22"H
- Pillow Two Measures 22"W x 16"H.
- Pillow Three Measures 24.5"W x 9.5"H



Pillow One

Pillow Two

Pillow Three



AV BASICS

CABINETS



QUALITY & VALUE

Based on twenty years of experience, we defined a line that combines popular styles with features we know will enhance the performance of most audio/video systems.

These are high quality pieces of furniture in enough styles that everyone will find something to fit their décor. The performance is built in, and best of all, they quick ship to you fully assembled.



QUALITY CONSTRUCTION

Solid, high-quality, fully assembled cabinets with premium hardware.



IR PASS-THRU

Remote-friendly glass doors allow pass-thru for remote control of electronics.



WIRE MANAGEMENT

Removable rear panels and cable raceways make managing and concealing cables easy.



VENTILATION

Built-in ventilation louvers keep gear cool to ensure optimal performance.



QUICK SHIP

Ships fully assembled within 3-5 days.





SDAV1

This classic American style in Matte Black or Warm Cherry fits comfortably in almost any decor. Framed wooden doors with integrated mullions and glass panes complete the aesthetic.



TRADITIONAL



SDAV1 5031

50"W x 31"H x 22.5"D

Black

SDAV1/B

Interior: includes two adjustable shelves

Upper Opening: 43"W x 6.8"H x 19.3"D

Door (each bay): 19.25"W x 16.6"H x 18"D

Capacities: TVs up to 55"

Top: 100 lbs.

Upper opening: 75 lbs.

Each Interior Shelf: 50 lbs.



SDAV1 6626

66"W x 26"H x 20"D

Black with Glass Doors

SDAV1/6626/B

Interior: includes six adjustable shelves

Outer Doors (each bay): 19.3"W x 20.75"H x 16.5"D

Center Door: 19"W x 20.75"H x 16.5"D

Capacities: TVs up to 75"

Top: 200 lbs.

Each Interior Shelf: 50 lbs.

SDAV2

This sleek, sophisticated design features recessed glass top and cabinet door fronts complemented by thick, wooden side panels in a Wenge Espresso finish.



SDAV5



Subdued, with nice character and details. Finger pulls add to a very clean look, and wide center opening accommodates large speakers. Medium Walnut or Black Oak finish.



SDAV2 7224

72"W x 24"H x 20"D

Wenge Espresso with Black Glass Doors

SDAV2/7224/W

Interior: includes two adjustable shelves
 Center Opening: 28"W x 8"H x 18.8"D
 Center Flip-Down Door: 28"W x 9.75"H x 18.8"D
 Outer Door (each bay): 20"W x 19"H x 18"D

Capacities: TVs up to 80"

Top: 200 lbs.
 Upper Opening: 50 lbs.
 Each Interior Shelf: 50 lbs.



SDAV5 7225

72"W x 25"H x 21"D

Black Oak with Smoked Glass Doors

SDAV5/7225/BO

Medium Walnut with Smoked Glass Doors

SDAV5/7225/MW

Interior: includes two adjustable shelves
 Doors (each bay): 20.7"W x 17"H x 18.5"D
 Center Opening: 26.4"W x 8.2"H x 17.1"D
 Center Drawer: 22.87"W x 6.77"H x 15.43"D

Capacities: TVs up to 80"

Top: 80 lbs.
 Center Opening: 30 lbs.
 Each Interior Shelf: 20 lbs.



AV BASICS

THEATER SEATING



MECHANISM

Electric Motorized Recliner.
In-arm control on end arm seats
and between seats on center seats.



COVER MATERIAL

Construct™ by Salamander Designs, a manufactured leather engineered for upholstery, is available in an attractive, durable and easily cleaned textured black grain finish. Construct™ is designed for regular, everyday use.



USB Charging Port

All TC3 chairs features an in-arm USB port (5V at 2A) and controls for power recline.



QUICK SHIP & ASSEMBLY

Enjoy your furniture sooner than later. AV Basics Seating are in stock and ready to ship from Connecticut. Easy Clip Assembly.



WARRANTY

Limited three year non-transferable warranty on frame, springs & recline mechanism, one year on electrical components and all cover material.

The TC3 offers comfort, style and value. Proper ergonomic design, generous padding and quality materials ensure maximum comfort that performs over time. This motorized recliner will please every member of the family, ensuring total comfort hour after hour spent enjoying favorite movies and sporting events. The cup holders add a convenient place for any beverage.

TC3 MODELS

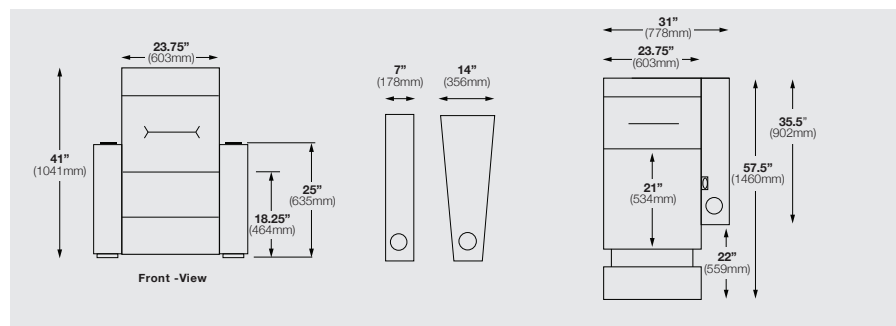
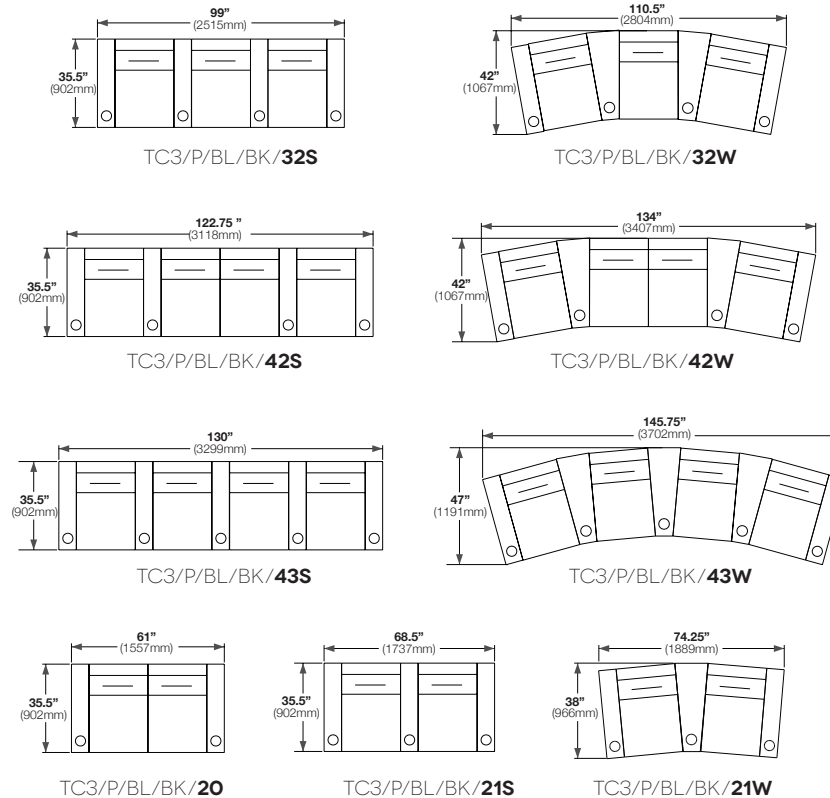

* Power Mechanism
Electrical Specifications:
110 V AC, 2.0 amps nominal
load, 5.0 amps max load,
thermally protected

MOUNTS

Salamander mounts are crafted like individual works of art, and the premium quality of their design ensures years of reliable operation.

Description	Screen Size		Max Weight Capacity	Universal Mounting	VESA Compliant	Distance From Wall	Tilt		Swivel	Rotation	Mounting
	min	max					up	down			
PLANO - Flat Wall Solutions	min	max	lbs	width x height	width x height						
Plano 100 Medium	23	47	100	min 3.9 x 3.9 - max 16.5 x 12.1"	min 100 x 100 - max 400 x 300	1.2"					Single Stud
Plano 100 Large	32	70	175	min 7.9 x 7.9 - max 32.3 x 20"	min 200 x 200 - max 800 x 500	1.2"					Double Stud
Plano/Flexo Combo 100 XL	50	90	175	min 11.8 x 11.8 - max 36 x 24"	min 300 x 300 - max 900 x 600	1.5" or 3.75"	15°	15°			Double Stud
FLEXO -Tilt Wall Solutions	min	max	lbs	width x height	width x height						
Flexo 100 Medium	23	47	100	min 3.9 x 3.9 - max 19.7 x 12.1"	min 100 x 100 - max 500 x 300	2.6"	15°	15°			Single Stud
Flexo 100 Large	32	70	175	min 7.9 x 7.9 - max 35 x 20.1"	min 200 x 200 - max 800 x 500	3.3	15°	15°			Double Stud
Flexo/Plano Combo 100 XL	50	90	175	min 11.8 x 11.8 - max 36 x 24"	min 300 x 300 - max 900 x 600	1.5" or 3.75"	15°	15°			Double Stud
DYNO - Articulating Wall Solutions	min	max	lbs	width x height	width x height						
Dyno 102 Small*	13	37	45		min 75 x 75 - max 200 x 200	3.5 - 18"	15°	15°	180°	360°	Single Stud
Dyno 102 Medium*	23	50	100		min 100 x 100 - max 200 x 200	3.5 - 17.6"	30°	30°	90°		Single Stud
Dyno 102 Medium Universal Adapter	32	50	100	min 7.9 x 7.9 - max 31.5 x 18.7"	min 200 x 200 - max 800 x 400						
ZOOM -Desk Solutions	min	max	lbs		width x height	height adj.					
Zoom 102 Dual	13	24	33		min 75 x 75 - max 100 x 100	11 - 14.8"	15°	15°	360°	360°	Desk
LUNA - Ceiling Solutions	min	max	lbs	width x height	width x height	height adj.					
Luna 200 Projector			30	3 or 4 hole mounting			45°	45°		360°	Ceiling
SYNCHRO - Integrated Solutions	min	max	lbs	width x height	width x height						
Synchro 100 Cable Manager Small, 20"				dims: 2.7"W x 19.7"H x 1.2"D							Single Stud
Synchro 100 Cable Manager Large, 41"				dims: 2.7"W x 41.3"H x 1.2"D							Single Stud



WALL & SPECIALTY MOUNTS



Dyno Articulating 102 Small

Silver	DY102/S
Graphite Black	DY102/S/BK



Flexo Tilt 100 Medium

Silver	FX100/M
Graphite Black	FX100/M/BK



Plano Fixed 100 Medium

Silver	PL100/M
Graphite Black	PL100/M/BK



Dyno Articulating 102 Medium

Silver	DY102/M
--------	---------



Flexo Tilt 100 Large

Silver	FX100/L
Graphite Black	FX100/L/BK



Plano Fixed / Flexo Tilt 100 X-Large

Silver	FX100/XL
Graphite Black	FX100/XL/BK

- Includes Both Fixed and Tilt TV Brackets



Dyno 102 Medium Universal Adapter

Black	MA/UA1/BK
-------	-----------

- Extends Dyno 102 Medium Mounting Pattern: min 7.9 x 7.9 - max 31.5 x 18.7"
- Maximum Weight Capacity: 88 lbs.

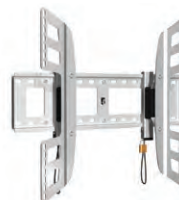

Flexo Tilt / Plano Fixed 100 X-Large

Silver	FX100/XL
Graphite Black	FX100/XL/BK

- Includes Both Fixed and Tilt TV Brackets.



Luna Ceiling 200 Projector

Silver	LU200/PJ
--------	----------



Hollow Wall Anchor

Set of 2	MA/ST2
Set of 4	MA/ST4

- Remedies steel stud, hollow block and other applications where conventional lag screws are not functional.



Zoom Desk 102 Dual

Silver	ZM102/D
--------	---------



OFFICE COLLABORATION **WORKPLACE** SOLUTIONS

Businesses today operate in fluid, dynamic environments. Salamander builds furniture that defines and shapes today's office – and tomorrow's. We help create adaptable, collaborative, enduring furniture that is built to perform and to last.

MOTORIZED & FIXED HEIGHT MOBILE STANDS

Fully adjustable, electric lift, mobile stands offer convenience and flexibility with designer style. A sleek and compact design moves easily between spaces. Designed for touch screen in working, drafting, collaboration and presentation positions.

For more information on our commercial offerings,
visit: salamandercommercial.com
or email: custom@salamanderdesigns.com



Electric Lift & Tilt
Mobile Stand



Fixed Height
Mobile Stand



Electric Lift
Wall Stand



PRODUCT WARRANTIES

Salamander is proud to stand behind our products with industry-leading warranties. Should you ever encounter any problem with your Salamander product, let us know. We are here to make it right. For full warranty details see:

<http://www.salamanderdesigns.com/customerservice/warranty>

CUSTOM AV FURNITURE

Lifetime Limited Warranty

Chameleon Collection
Synergy System
Archetype System
Accessories (Non-Electronic)

ELECTRONIC ACCESSORIES

Two (2) Year Limited Warranty

AV BASICS

CABINETS - Two Year Limited Warranty

SEATING - Three (3) Year Limited Warranty on frame, springs & recline mechanism and one (1) year on all cover material.

CUSTOM SEATING

Lifetime Limited Warranty

Alex, Isabella, Matteo, Olivia, Luca, Lilliana, & Talia

- Frame / Suspension: Lifetime
- Reclining Mechanism, Frame & Suspension: Lifetime Limited Warranty
- Seat Cushions: Two (2) Year Warranty
- Upholstery Fabric, Leather, Electronic and Powered Components:

TV MOUNTS

MOTORIZED - Two (2) year Limited Warranty

MANUAL - Five (5) year Limited Warranty

To receive your **Lifetime Warranty** please be sure to Register your purchase at www.salamanderdesigns.com/customerservice/warrantyform.





TRADE PROGRAM

All qualified interior designers, decorators and architects are invited to join the Salamander's Trade Program. As a member, you'll have access to special sales, promotions, and discounts that fit the needs of your unique project. Our highly customizable collections of furniture and seating will help you create innovative furniture concepts that satisfy business needs, delighting customers and clients

Dealer/Designer Program Benefits

- Trade Discounts
- White Glove delivery options available
- Access to Salamander Factory Design Consultants
- Granted full Showroom Access
- Delivery & Installation Services
- Designer Resources
- Build-To-Order and Quick-Ship-Capability

Contact your Salamander Sales Rep for more details.

www.salamanderdesigns.com/designers



Visit [SalamanderDesigns.com](https://www.salamanderdesigns.com) for the latest products and discover which material will look best in your home by requesting swatches.



Salamander Designs Ltd.

For Sales Inquiries:
800.535.9910 or 860.761.9500
sales@salamanderdesigns.com

Download Digital Copy
www.salamanderdesigns.com/downloads/referenceguide.pdf

501-110 V7.19

