

IMPORTANT

Carefully remove all the parts from the carton and place them individually on a soft cloth to prevent scratches or other damage.

Carefully and strictly follow these assembly instructions to ensure a completed product as designed.

Do not use power tools above 8 volts to assemble.

Part List

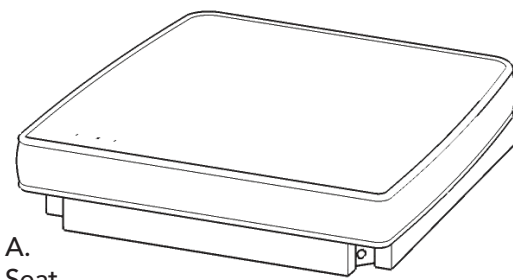

A.
Seat
1 pc.

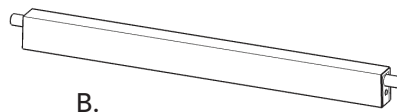

B.
Stretcher
1 pc.

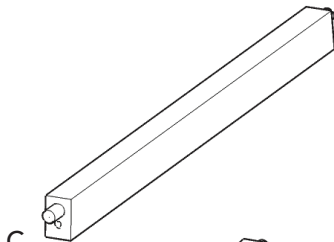

C.
Stretcher
1 pc.

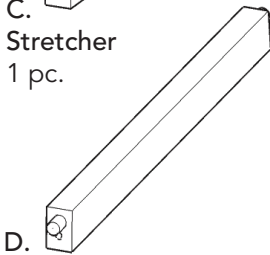

D.
Stretcher
1 pc.



E.
Leg
1 pc.



F.
Leg
1 pc.

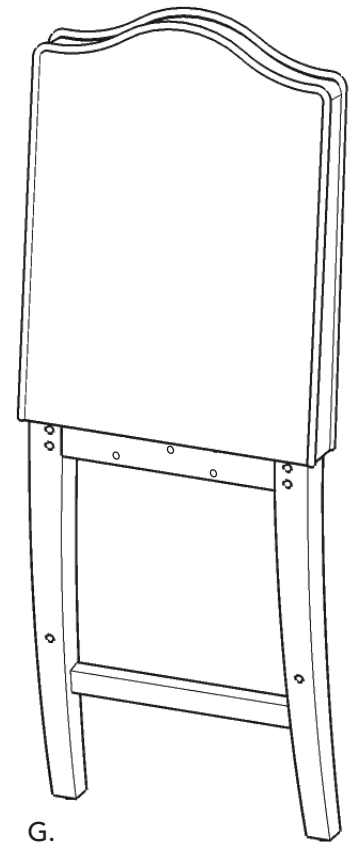

G.
Back Frame
1 pc.

Hardware List



Hex Wrench
1 pc.



M3.5x40
Wood Screw
6 pcs. (+1 extra)



M8x40
Head Cap Bolt (short)
3 pcs. (+1 extra)



Flat Washer
11 pcs. (+1 extra)



Small
Hex Wrench
1 pc.



M8x76
Head Cap Bolt (long)
4 pcs. (+1 extra)



M8x50
Head Cap Bolt
4 pcs. (+1 extra)



Spring Washer
11 pcs. (+1 extra)

Tool(s) required for assembly: Phillips screwdriver

Assembly Instructions 2/2

IMPORTANT

Use a soft cloth between these parts and the floor.
 Do not use power tools above 8 volts to assemble.
 Do not tighten all the bolts until each part is properly assembled.
 Keep Hex Wrench in a safe place as the bolts may need to be tightened up in the future.

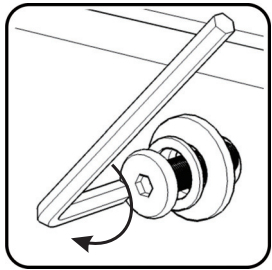

Figure 1

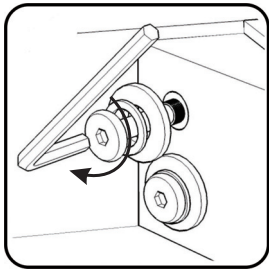
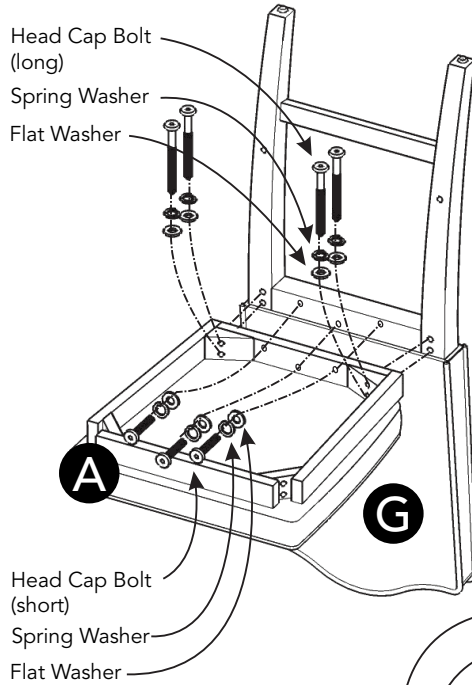

Figure 2



STEP 1

Attach Seat (A) to Back Frame (G) with Flat Washers, Spring Washers, Head Cap Bolts (long) and Head Cap Bolts (short).
 (See Figures 1 and 2)

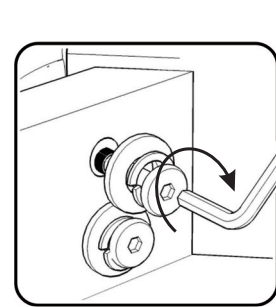

Figure 3

STEP 2

Put end of Stretcher (C) into hole in Back Frame.

Slide Leg (E) into position on the unit with other end of Stretcher (C) in hole in Leg (E).

Attach Leg (E) to unit with Flat Washers, Spring Washers and Head Cap Bolts.
 (See Figure 3)

Attach Stretcher (C) to unit with Wood Screws.
 (See Figure 4)

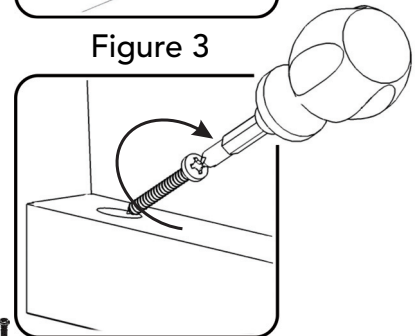
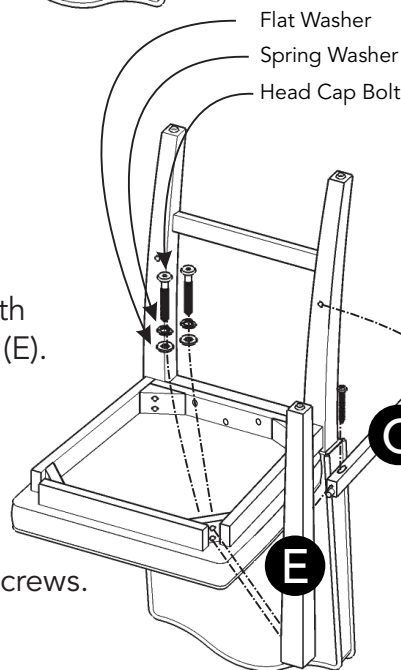
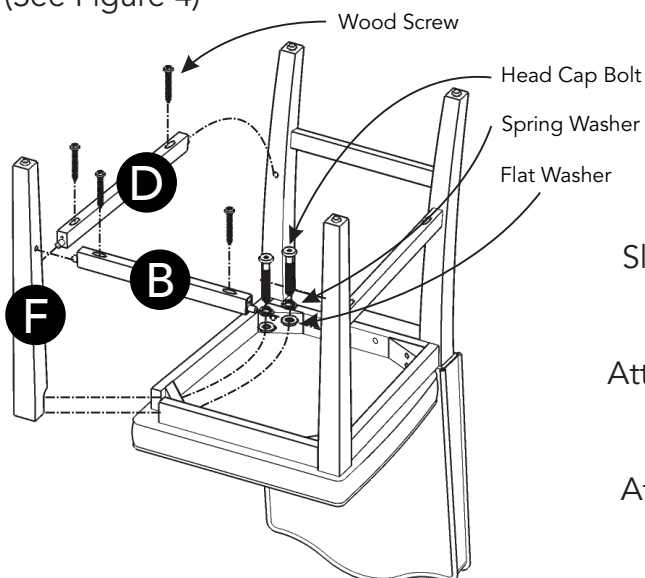

Figure 4



STEP 3

Put end of Stretcher (D) into hole in Back Frame and end of Stretcher (B) into hole in Leg (F).

Slide Leg (F) into position on the unit with other end of Stretchers (B) and (D) in holes in Leg (F).

Attach Leg (F) to unit with Flat Washers, Spring Washers and Head Cap Bolts.

Attach Stretchers (B) and (D) to unit with Wood Screws.

Tighten all Head Cap Bolts and Wood Screws.

CARE INSTRUCTIONS

NEVER

allow liquids to remain on furniture.
Absorption causes parts to warp
and split and finishes to delaminate.

NEVER

use glass cleaners on
finished furniture. Ammonia
chemically attacks the finish.



Do not use power tools
above 8 volts to assemble.

**PREVENT
CRACKING**



Do not place
in direct sunlight.

**PREVENT
FADING**



Do not write
directly on surface.

**PREVENT
MARKING**



Do not place hot
objects on surface.

**PREVENT
FINISH DAMAGE**

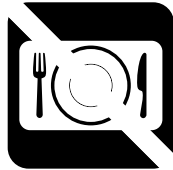

Do not use rubber
based placemats.

**PREVENT
DISCOLORING**



Do not use commercial
waxes and polishes.

**PREVENT
YELLOWING**

CLEAN

with a soft cloth moistened
in lukewarm soap and water.
Buff with a dry clean cloth.



Home Styles will provide replacements free of charge for missing or damaged hardware or parts within 30 days of purchase. Digital images of the defective parts may be required. If the product was not purchased from an authorized retail affiliate, Home Styles is under no obligation to provide replacement parts. Parts are not available for fully assembled items nor are parts available for sale. Replacements for missing or damaged hardware or parts may be requested at:

www.homestyles-furniture.com/customer-service/replacement-parts

Home Styles Customer Service: www.homestyles-furniture.com,
servicedesk@homestyles-furniture.com, 888-680-7460, 877-831-0319