



Stealthbox®

INSTALLATION GUIDE
for the

SB-J-JL4DDR/10TW1-2

SB-J-JL4DDR/10TW1-4

SKU# 94664 (2 Ω) & 94665 (4 Ω)

SB-J-JL4DPAS/10TW1-2

SB-J-JL4DPAS/10TW1-4

SKU# 94666 (2 Ω) & 94667 (4 Ω)

2018-Up Jeep Wrangler (JL) 4-Door

Enclosure Type: Sealed

Driver Type: 10TW1

Nominal Impedance: 2 or 4 ohms

Continuous Power Handling: 300 watts (RMS method)

! IMPORTANT

If you choose to perform the installation yourself, it is absolutely vital that the Stealthbox® be properly mounted to the vehicle according to these instructions. Failure to mount the enclosure properly presents two problems:

- 1) The sub-bass performance will suffer due to the movement of the enclosure caused by the force exerted by the woofer(s).
- 2) A loose enclosure presents a serious safety hazard in the event of a collision or sudden deceleration.

INSTALLATION
DIFFICULTY:

4 ^{OUT}
OF **5**

ESTIMATED TIME:
2-3 HOURS



Thank you for choosing a JL Audio Stealthbox® for your automotive sound system. With proper installation, your new vehicle-specific enclosed subwoofer system will deliver years of listening pleasure.

We strongly recommend that you have your new Stealthbox® installed by your authorized JL Audio dealer. The installation professionals employed by your dealer have the necessary tools and experience to disassemble and reassemble your vehicle properly. If you prefer to perform your own installation, please read this installation guide completely before beginning the process.

INCLUDED HARDWARE

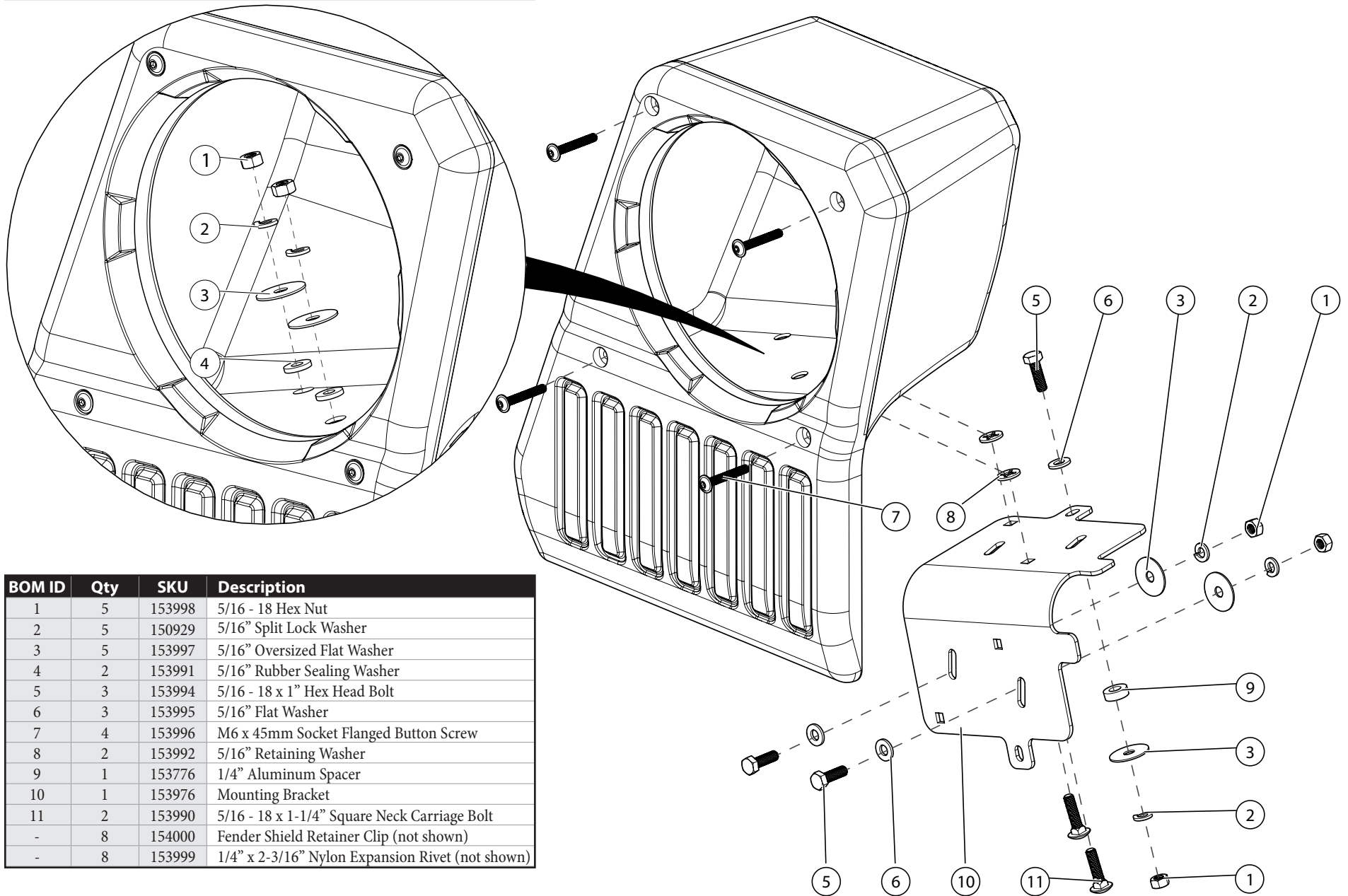

POWER RECOMMENDATION

JL Audio recommends high quality amplifiers such as the JL Audio XD300/1v2. The diagram below shows the recommended crossover settings for the XD300/1v2. For a detailed description of the amplifier settings, consult the owner's manual for the amplifier. If another amplifier is being used, please reference this illustration and use similar settings on that amplifier.

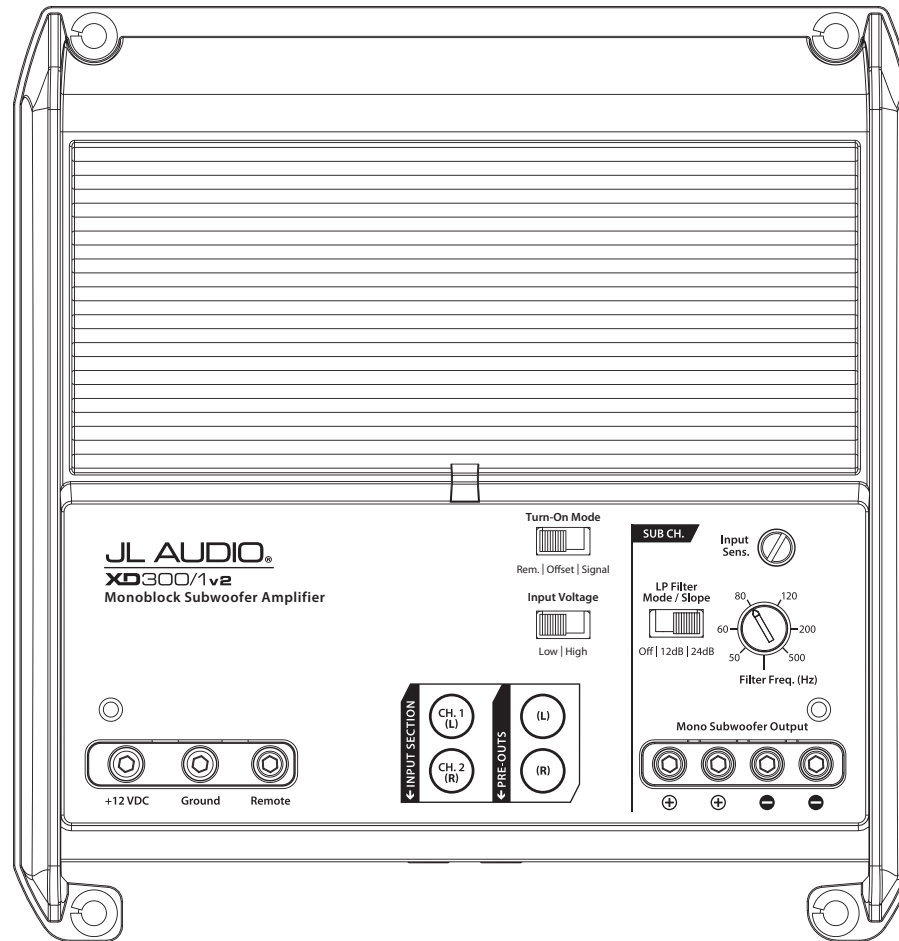

CONNECTIONS

Using quality power, signal, and speaker wire is essential in ensuring the performance of your Stealthbox®. JL Audio recommends using a 4 AWG power kit such as the XD-PCS4-1B for your Stealthbox® amplifier. Other kits are available should you be using more than one amplifier. Signal wire such as the JL Audio Premium Audio Interconnect Cables should be used to provide signal for both channels of the amplifier. JL Audio recommends using 12 AWG speaker wire for subwoofers such as our XC-BCS12-25.



STEP 1

NOTE: This manual illustrates the installation of the passenger side Stealthbox®. The installation procedure for the driver side Stealthbox® will be the same.

The rear wheel has been removed for illustrative purposes only. It will not be necessary to remove the wheel in most instances.

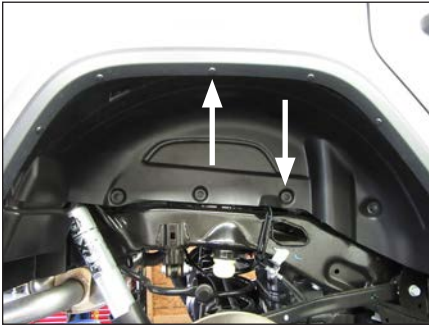

STEP 2

Locate the eight shield retainer clips and six nylon rivets that secure the inner fender liner to the vehicle.



STEP 3

Unclip and remove the eight shield retainer clips.



STEP 4

Using a utility knife or diagonal cutters, carefully cut through the six nylon rivets between the inner fender liner and the plastic fender trim.

Note: Do not cut the two outermost nylon rivets. They do not need to be removed.

Remove the inner fender liner from the vehicle.



STEP 5

Empty the cargo area of the vehicle.



STEP 6

Fold the seat back forward.



STEP 7

Unclip and remove the carpet retainer clip. This will not be reinstalled.



STEP 8

Pull the carpet away from the wheel well.



STEP 9

Position the Mounting Bracket as shown. The curved surface will rest on the contoured wheel well, and the indicated tab should be flush with the front edge of the raised rib.



STEP 10

With the Mounting Bracket held in position, mark the location of the two indicated slots. Keep the Mounting Bracket in position for the next step.

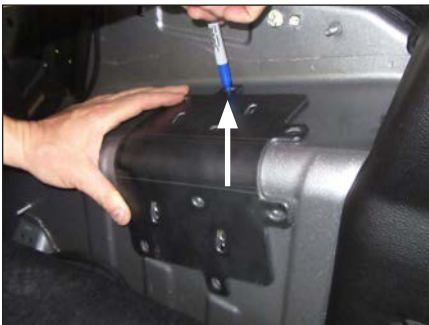

STEP 11

With the Mounting Bracket in position, mark the location of the indicated hole. Remove the Mounting Bracket.



STEP 12

Using a step drill bit, carefully drill through the top ends of the marks made in **Step 10**, and enlarge the holes to 3/8".

Carefully drill through the mark made in **Step 11**, and enlarge the hole to 3/8".

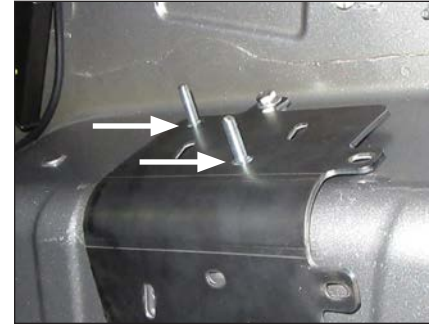

STEP 13

Pass a 5/16 - 18 x 1-1/4" Square Neck Carriage Bolt through the bottom of each of the square holes in the Mounting Bracket, as shown. Push a 5/16" Retaining Washer over each of the 5/16 - 18 x 1-1/4" Square Neck Carriage Bolts.

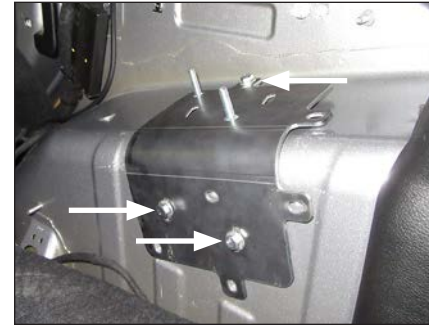

STEP 14

Slide a 5/16" Flat Washer over a 5/16 - 18 x 1" Hex Head Bolt, and pass the assembly through the upper hole in the Mounting Bracket, through a 1/4" Aluminum Spacer, and through the hole drilled in the wheel well.

Repeat the process for the lower holes, except without the spacers.



STEP 15

From outside the vehicle, slide a 5/16" Oversized Flat Washer, a 5/16" Split Lock Washer, and a 5/16 - 18 Hex Nut over the upper 5/16 - 18 x 1" Hex Head Bolt, and hand tighten.



STEP 16

Slide a 5/16" Oversized Flat Washer, a 5/16" Split Lock Washer, and a 5/16 - 18 Hex Nut each of the lower 5/16 - 18 x 1" Hex Head Bolts, and hand tighten.

Fully tighten the upper 5/16 - 18 Hex Nut installed in the previous step, then fully tighten the two lower 5/16 - 18 Hex Nuts.



STEP 17

Push the carpet back down to the wheel well. Locate the locations of the two 5/16 - 18 x 1-1/4" Square Neck Carriage Bolts. Cut a small "X" in the carpet to allow the hardware to pass through.

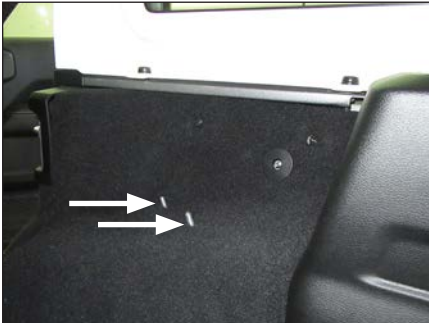

STEP 18

Pass the 5/16 - 18 x 1-1/4" Square Neck Carriage Bolts through the cuts in the carpet, as shown.



STEP 19

Remove the four M6 x 45mm Socket Flanged Button Screws from the front of the Stealthbox®.



STEP 20

Remove the trim panel from the enclosure.



STEP 21

Remove the eight subwoofer mounting screws. Disconnect the subwoofer, and remove it from the enclosure. Remove the batting from the enclosure.

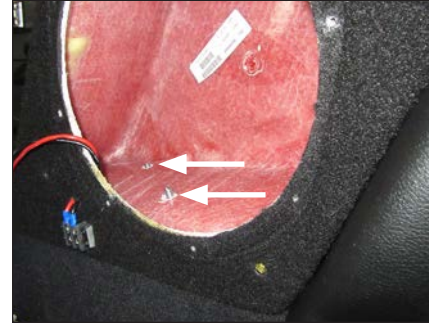

STEP 22

Place the enclosure onto the wheel well, allowing the two 5/16 - 18 x 1-1/4" Square Neck Carriage Bolts to pass through the holes in the bottom of the enclosure.



STEP 23

Slide a 5/16" Oversized Flat Washer and a 5/16 - 18 Hex Nut over each of the 5/16 - 18 x 1-1/4" Square Neck Carriage Bolts, and fully tighten. This allows the enclosure to seat properly over the Mounting Bracket.

Remove the 5/16 - 18 Hex Nut and 5/16" Oversized Flat Washer from only one of the 5/16 - 18 x 1-1/4" Square Neck Carriage Bolts.



STEP 24

Slide a 5/16" Rubber Sealing Washer, the 5/16" Oversized Flat Washer, a 5/16" Split Lock Washer, and the 5/16 - 18 Hex Nut over the empty 5/16 - 18 x 1-1/4" Square Neck Carriage Bolt, and fully tighten.

Repeat the process for the other 5/16 - 18 x 1-1/4" Square Neck Carriage Bolt.



STEP 25

Reinstall the batting. Connect and reinstall the subwoofer and eight subwoofer mounting screws.

Connect speaker cable to the barrier strip on the front of the enclosure, and route the cable as necessary.



STEP 26

Reinstall the trim panel and four M6 x 45mm Socket Flanged Button Screws.

Fold the seat back up.



STEP 27

Reinstall the inner fender liner, and secure the inner portion with eight Fender Shield Retainer Clips.



STEP 28

Using a poly hand riveter, secure the outer portion of the inner fender liner with six 1/4" x 2-3/16" Nylon Expansion Rivets.

CONGRATULATIONS!

You have completed the installation for this model! Enjoy your new Stealthbox®!



MID/HIGH FREQUENCY DRIVER FITMENT

A variety of JL Audio coaxial and component systems will fit in the factory speaker locations of your vehicle.

Location / OEM Speaker Size	Suggested JL Audio Speaker Models		
	Coaxial Models	Component Models	
Dash	Upper / 3-1/2-inch	C2-350x	C7-350cm
	Lower / 4-inch	C1-400x, C2-400x	C5-400cm
Roll Bar	Outer / 3-1/2-inch	C2-350x	C7-350cm
	Inner / 4-inch	C1-400x, C2-400x	C5-400cm

JL AUDIO | How we play.®    

(954) 443-1100

www.jlaudio.com

All specifications are subject to change without notice. "JL Audio" and "How we play" are registered trademarks of JL Audio, Inc. "Ahead of the Curve" and its respective logo are trademarks of JL Audio, Inc.

Printed in USA • ©2018 JL Audio, Inc. • For more detailed information please visit us online at www.jlaudio.com.

JLA-SKU# 011510 • ver. 11.29.2018 • 10369 NORTH COMMERCE PARKWAY • MIRAMAR, FLORIDA • 33025 • USA



011510