

# 50" HYBRID GRILL

Model No. C1HY50



## Charcoal Side Features:

- Adjustable fuel tray
- 600 sq. in. cooking area
- For use with charcoal or wood chips
- Adjustable dampers for controlling air flow

## Gas Grill Features:

- Two high performance Coyote iBurners™
- 600 sq. in. cooking area
- Up to 40,000 BTU
- Complete 304 stainless steel construction
- Interior grill lighting
- Integrated wind guard

## Dimensions:

- Cutout: (H) 12 1/2" X (W) 47 3/4" X (D) 20 1/2"
- Overall: (H) 25 1/2" X (W) 50" X (D) 25 1/2"

## Accessories:

- Laser-Cut Signature Grates (CSIGRATE12)
- 14" stainless steel griddle (C1GRDL)
- Stainless steel cart available
- Custom fit, weather resistant cover
- Gas conversion kit

# C1HY50 PRODUCT SPECS

## DIMENSIONAL RENDERINGS

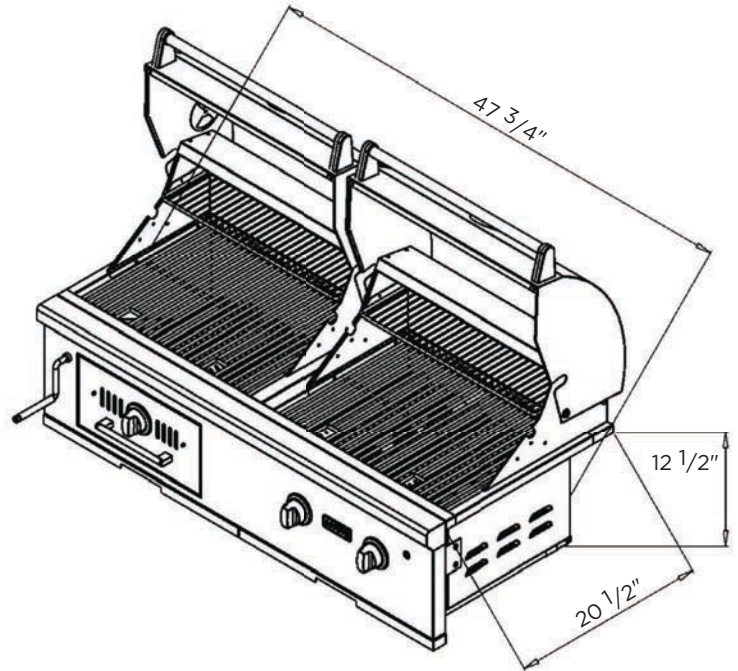
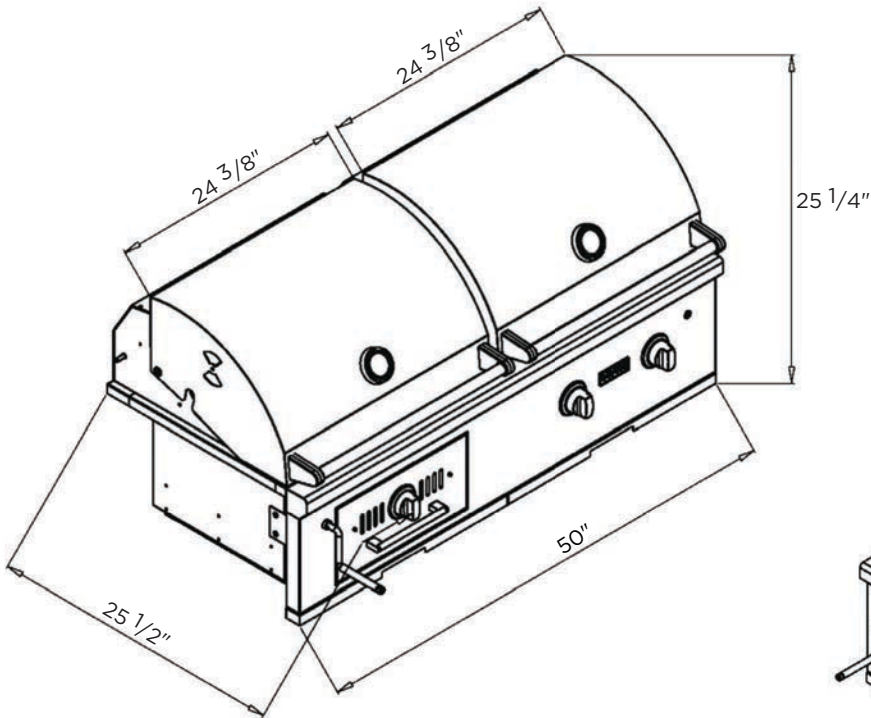

Overall Product Dimensions			
Model No.	Height	Width	Depth
C1HY50	25 1/4"	50"	25 1/2"

Cutout Dimensions for Island			
Model No.	Height	Width	Depth
C1HY50	12 1/2"	47 3/4"	20 1/2"

✓ Due to the C1HY50 grills ability to cook with charcoal, this grill can NOT be built into a combustible material island and there is no insulated jacket available.

Model No.	Gas Supply	BTU's	Regulator	WC Pressure	Max PSI	Electrical Requirements
C1HY50LP	Propane	40,000	20 lb Tank Regulator	11"	.5 PSI	Qty 1 - 120 VAC 60 Hz Grounded Plug
C1HY50NG	Natural Gas	40,000	1/2" Female Pipe	4"	.5 PSI	Qty 1 - 120 VAC 60 Hz Grounded Plug

**Important Note to Installer:** This file is not intended to replace your Owners' Manual which contains specific safety requirements and consumer guidelines. Please refer to your Owners' Manual prior to installing or operating your built-in grill.