

# OWNER'S MANUAL



## MediaMaster® 50

*Thank you for purchasing a JL Audio MediaMaster®  
Source Unit for your sound system.*

*This product has been designed and manufactured to exacting standards in order to deliver years of musical enjoyment. For maximum performance, we highly recommend that you have your MM50 installed by an authorized JL Audio dealer. Your authorized dealer has the training, expertise and installation equipment to ensure optimum performance from this product. Due to the complexity of modern vehicle systems, we do not recommend self-installation unless you have extensive experience in automotive and marine electrical systems. Should you decide to install this product yourself, please take the time to read this manual thoroughly to familiarize yourself with its installation requirements and setup procedures.*

*If you have any questions regarding the instructions in this manual or any aspect of the product's operation, please contact your authorized JL Audio dealer for assistance. If you need further assistance, please contact the JL Audio Technical Support Department at [technical@jlaudio.com](mailto:technical@jlaudio.com) or call (954) 443-1100 during business hours.*



### **Protect Your Hearing!**

We value you as a long-term customer. For that reason, we urge you to practice restraint in the operation of this product so as to not damage your hearing and that of others in your vehicle. Studies have shown that continuous exposure to high sound pressure level can lead to permanent (irreparable) hearing loss. Mobile sound systems are capable of producing such high sound pressure levels. Please limit your continuous exposure at high volumes. While driving, operate your audio system in a manner that still allows you to hear necessary noises to operate your vehicle/vessel safely (horns, sirens, etc.).

### **FCC Compliance Statement**

This equipment has been tested and found to comply with the limits of Part 15 of the FCC Rules. These limits are designed to provide reasonable protection against harmful interference in a residential installation. This equipment generates, uses and can radiate radio frequency energy and, if not installed in accordance with the instructions, may cause harmful interference to radio communications. However, there is no guarantee that interference will not occur in a particular installation. If this equipment does cause harmful interference to radio or television reception, the user is encouraged to try to correct the interference by one or more of the following measures:

- Reorient or relocate the receiving antenna.
- Increase separation between the equipment and the receiver.
- Connect the equipment to an outlet on a circuit different from that to which the receiver is connected.
- Consult the dealer or an experienced radio/TV technician for help.

Any changes or modifications not expressly approved by the party responsible for compliance could void the user's authority to operate this equipment.

## **Safety Considerations**

- Install this product in a dry, well-ventilated location that does not interfere with your factory-installed systems. If a dry environment is not available, a location that is not exposed to heavy splashing may be used.
- While this product is designed to be water-resistant, it should never be submerged under water or subjected to high-pressure water spray.
- Do not mount this product in an engine compartment or areas of extreme heat. Areas exposed to a heater or hot air should also be avoided.
- Securely mount this product so that it does not come loose in the event of a collision, sudden jolt or as a result of repeated vibrations during normal use.
- Check before drilling to make sure that you will not be drilling into an exterior panel/hull, fuel tank, gas/brake line, wiring harness or other vital system.
- Do not run system wiring outside or underneath the vehicle/vessel. This is an extremely dangerous practice, which can result in severe damage/injury.
- Protect all system wires from sharp edges and wear by carefully routing them, tying them down and using grommets and loom where appropriate. Secure all wiring using cable ties or wire clamps, as needed.
- Do not replace the power wire fuse with one of a different value. Never bypass the fuse.
- Never make power connections with a "live" wire. Failure to make safe, tight, high-integrity connections can result in fire and extensive damage.

## **Installation Applications**

This product is designed for operation with 12 volt, negative-ground electrical systems. Using this product in systems with positive ground and/or voltages other than 12 volts may result in damage to the product and will void the warranty. This product is not certified or approved for use in aircraft.

## **What Is Included**

- (1) MediaMaster® MM50 Source Unit
- (1) Power Connections Wire Harness
- (1) Speaker Outputs Wire Harness
- (1) Mounting gasket
- (1) Mounting template
- (4) Mounting screws
- (1) Protective Sun Cover
- (1) Owner's manual

## **Product Description**

The MediaMaster® MM50 is a weather-resistant source unit designed for marine and powersports applications.

## The MM50 includes the following features:

- Water-resistant chassis and display (IP66 rated) is built to withstand the elements
- Intuitive interface with easy-to-read, high-brightness, 2.8-inch full-color LCD display with large controls
- Programmable day/night lighting modes for display, buttons and remote, plus a dedicated Day/Night toggle button
- Digital AM/FM tuner with RDS (Radio Data System) to display extended FM program info, where available
- Quick access to 18 of your favorite AM/FM stations
- USB direct-digital connection accesses music files on your USB storage device or iPhone®
- Bluetooth® v2.1 receives top-quality audio from compatible devices with playback control, up to 35 ft. (11 m) away
- 2.1A USB output conveniently charges your phone or portable music player
- Auxiliary inputs accept audio signals from any source with line-level outputs
- NMEA 2000® Certified - MFD (Multi-Function Display) control functionality via vessel networks (Refer to MFD manufacturer for device compatibility.)
- User customizable naming for display on Bluetooth® devices and MFDs
- Built-in amplifier generates 100 watts of high-fidelity power (25W RMS x 4)
- Two sets of 4V RMS line-level outputs deliver crystal-clear audio signals to your amplifiers, plus dedicated subwoofer outputs
- Both Zone 1 and 2 output types (speaker and line-level) feature onboard high-pass crossover with frequency selection (off/60/80/100/150 Hz)
- Subwoofer zone outputs equipped with a 500 Hz low-pass crossover
- Configurable zone feature/control options include:
  - Level Control Mode** options for on-the-fly volume adjustments of all zones, together or individually. Each zone can be independently configured as:
    - **Variable:** The volume knob adjusts all zones simultaneously, with independent control of each zone's relative offset level.
    - **Fixed:** Sets the output level of selected zones at a specific output voltage (4V, 2V or 1V RMS) that is not affected by the volume control.
    - **Off:** Disables the output level of selected zones.
  - Tone Control Mode** options allow customization of treble, midrange, bass and balance settings as:
    - **Same as Zone 1:** Links the controls of with Zone 1.
    - **Independent Tone Control** maintains separate control.
  - Volume Limit** allows you to set a custom, maximum allowable volume level for each zone.
  - Rename Zone** permits the creation of custom names for each zone, or choose from a list of preset location names.
  - Subwoofer zone's** level and tone controls can be linked to proportionally track (follow) Zone 1 or 2 or disabled. The offset level of volume for each zone is independently adjustable
- Three remote controller options available: (each sold separately)
  - MMR-10W Wireless, Waterproof Remote Controller (key-fob style)
  - MMR-20-BE Wired Remote Controller
  - MMR-40 Full-Function NMEA 2000® Network Controller with LCD display

## MOUNTING AND INSTALLATION

The diagram below shows a typical mounting procedure into a fiberglass panel. **Always follow proper safety procedures. Wear eye-protection at all times with a dust mask and gloves when cutting.** A mounting template is included to aid in measuring and marking the mounting surface before cutting or drilling.

1. Press along the perforation to remove the center section of the mounting template. (Discard the center section.) The template can be used to verify there is sufficient flat surface area for mounting and as a guide for cutting the opening. Tape the template to the mounting location and mark the surface for cutting the opening and drilling pilot holes.
2. Use a jigsaw or rotary tool to cut an opening in the mounting surface. If necessary, use a file or sandpaper to adjust the opening for proper fitment and smooth the edges.
3. Place the MM50 into the opening and check that the mounting holes remain aligned with the pilot hole marks taken from the template. If not, adjust and mark new holes as necessary.
4. Remove the MM50 and drill four (4) pilot holes in the mounting surface at the pilot hole marks.
5. Peel the adhesive backing from the mounting gasket and affix to the rear of the bezel. Connect all wiring and place the MM50 into the opening.
6. Secure the MM50 using the four (4) mounting screws. Press the trim ring onto the front of the MM50.

### ! IMPORTANT

**Before drilling or cutting, make sure there is adequate space behind the mounting surface to fit the MM50, including its wire harness.**

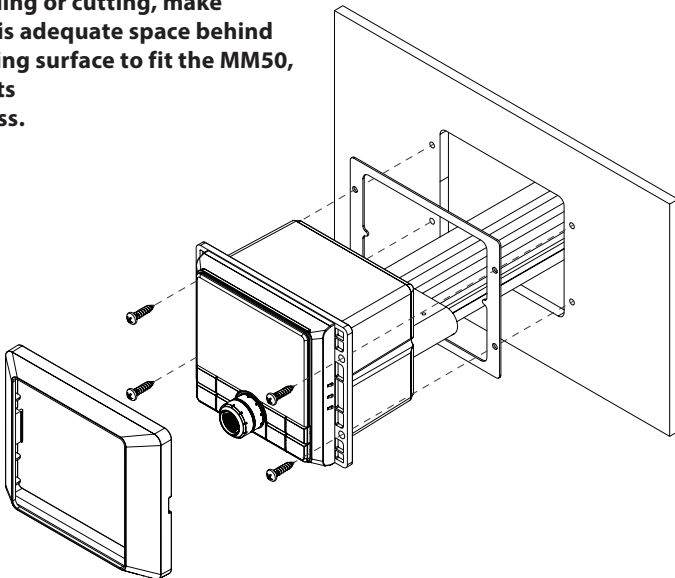

# GENERAL CONNECTIONS

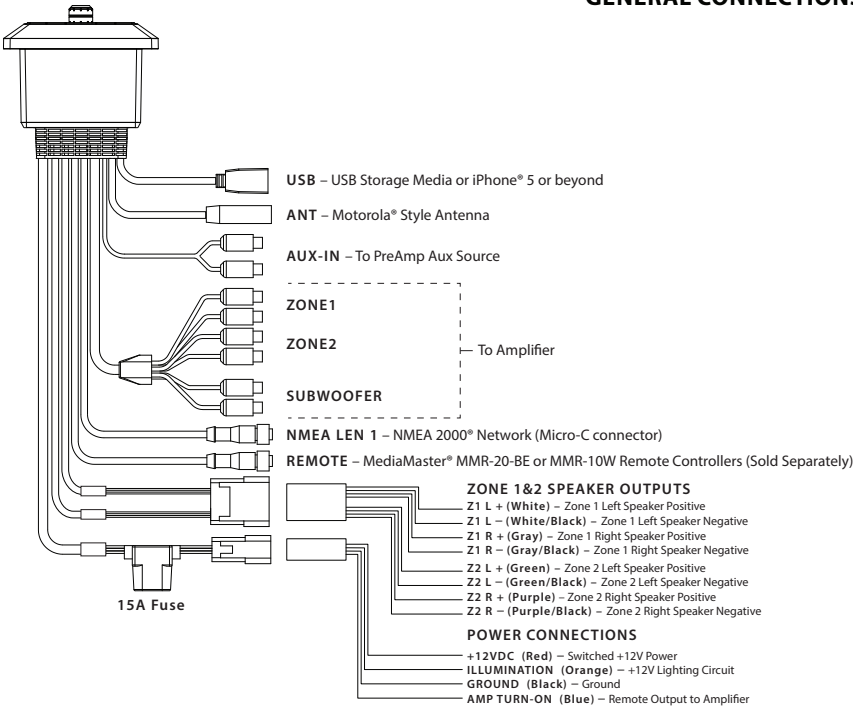

## WIRING HARNESS CONNECTIONS

Harnesses exiting the rear of the unit are used to connect to speakers, aftermarket amplifiers/equipment and media devices. Depending on your specific equipment, you may or may not use all of the connections. **Make sure to plan the layout of your system prior to routing wires and making connections.** Refer to the table at right for details.

## ! IMPORTANT







**Disconnect the NEGATIVE battery post connection and secure the disconnected cable to prevent accidental reconnection. This is an essential safety precaution during installation!**

## WIRING & CONNECTIONS

Label	Wire Color	Connection	
+12VDC	Red	Connect to a switched positive (+12V) source. This can be an ignition controlled, accessory circuit or a vessel battery equipped with a main disconnect switch. For added control functionality, we also recommend installing a dedicated toggle switch (not included) at this wire lead's +12V connection point. <b>Always install an appropriate fuse within 18 inches (45 cm) of the +12V connection.</b> If this is the only device using the connection point, use a 15 amp fuse.	
GROUND	Black	Connect to a clean metal chassis ground, if available. If no metal chassis ground is available, it may be necessary to connect this to the NEGATIVE battery post. <b>All ground connections (source unit and amplifiers) should be made at the same location to minimize noise.</b>	
ILLUMINATION	Orange	Connect to a +12V lighting circuit to automatically switch the illumination to night mode when the lights are activated.	
AMP TURN-ON	Blue	This wire provides a positive (+12V) turn-on voltage to activate aftermarket amplifiers and equipment.	
Z1 L+	White	(+) Positive Left Speaker / Zone 1	See <b>Audio Zone Setup</b> on pages 15-16 for configurable settings
Z1 L-	White/Black	(-) Negative Left Speaker / Zone 1	
Z1 R+	Gray	(+) Positive Right Speaker / Zone 1	
Z1 R-	Gray/Black	(-) Negative Right Speaker / Zone 1	
Z2 L+	Green	(+) Positive Left Speaker / Zone 2	
Z2 L-	Green/Black	(-) Negative Left Speaker / Zone 2	
Z2 R+	Purple	(+) Positive Right Speaker / Zone 2	
Z2 R-	Purple/Black	(-) Negative Right Speaker / Zone 2	
Label	Description	Connection	
ZONE1	Black RCA	Left Channel Signal Output / Zone 1	
	Red RCA	Right Channel Signal Output / Zone 1	
ZONE2	Black RCA	Left Channel Signal Output / Zone 2	
	Red RCA	Right Channel Signal Output / Zone 2	
SUBWOOFER	Black RCA	Left Channel Signal Output / Subwoofer	
	Red RCA	Right Channel Signal Output / Subwoofer	
AUX-IN	Black RCA	Left Channel Signal Input / Auxiliary	
	Red RCA	Right Channel Signal Input / Auxiliary	
ANT	Antenna	Connect to Motorola style antenna	
USB	USB Connector	Connect to USB storage device or iPhone® (see pages 12-13 for info)	
REMOTE	5-pin Threaded Connector	Connect to MMR-20-BE (wired) or MMR-10W (wireless) remote controllers (each sold separately)	
NMEA LEN 1	5-pin Micro-C Connector	Connect to MMR-40 Network Controller or NMEA 2000® network (requires NMEA 2000® cables, connectors, etc. (sold separately)	

## GENERAL CONTROL FUNCTIONS

Below is a list of general commands, including many common operations. The functionality of each control will vary depending on the current source and menu selected.

 SOURCE	Source/ Power	Use this button to turn ON or OFF and to access the source selection menu. <ul style="list-style-type: none"> <li>• Press to turn the unit ON</li> <li>• Press to display the <b>SOURCE: Select</b> menu</li> <li>• Press and hold to turn the unit OFF</li> </ul>		
VOL/SEL (Knob)	Volume/ Select	Use this knob as a Main Volume Control and for menu navigation/selection.		
		<ul style="list-style-type: none"> <li>• Rotate to adjust volume</li> <li>• Rotate to scroll thru menu options</li> <li>• Press to choose/enter (menu options)</li> </ul>	<ul style="list-style-type: none"> <li>• Rotate/press to access/adjust the <b>Audio Zone Level</b> menu screen (see pages 15-16 for more info)</li> </ul>	
	Back/ Menu	Use this button to go back/return and to access the menu options. <ul style="list-style-type: none"> <li>• Press to go back or return to the Now Playing Screen (AM/FM/AUX)</li> <li>• Press to access main menu options (USB/Bluetooth®)</li> </ul>		
	Favorites	Use this button to save, view or edit preset channels (up to 18). <ul style="list-style-type: none"> <li>• Press and hold to store a channel (AM/FM) as a preset (star will turn solid)</li> <li>• Press to view your list of stored presets and the <b>Favorites: Edit</b> menu.</li> </ul>		
	Settings	Use this button to access the main system setting menus and audio settings. <ul style="list-style-type: none"> <li>• Press and hold to access the <b>System Settings: Main Menu</b></li> <li>• Press to access the <b>Tone, Balance &amp; Crossover</b> menu</li> </ul>		
	Forward	Use this button to make a forward selection. <b>Press to:</b> <ul style="list-style-type: none"> <li>• Tune in the next frequency (AM/FM)</li> <li>• Select the next track (USB/Bluetooth®)</li> </ul> <b>Press and hold to:</b> <ul style="list-style-type: none"> <li>• Seek to the next channel (FM) or Skip forward ten frequency steps (AM)</li> <li>• Fast-forward (USB)</li> </ul>		
		Use this button to make a backward selection. <b>Press to:</b> <ul style="list-style-type: none"> <li>• Tune in the previous frequency (AM/FM)</li> <li>• Select the previous track (USB/Bluetooth®)</li> </ul> <b>Press and hold to:</b> <ul style="list-style-type: none"> <li>• Seek to the previous channel (FM) or Skip backward ten frequency steps (AM)</li> <li>• Fast-rewind (USB)</li> </ul>		
	Mute/ Pause/ Resume/	Use this button to pause/resume/mute audio and to access USB play options.		
		<ul style="list-style-type: none"> <li>• Press to mute audio (AM/FM/AUX)</li> <li>• Press to pause or resume the current selection (USB/Bluetooth®)</li> </ul>	<ul style="list-style-type: none"> <li>• When the <b>Audio Zone Level</b> screen is displayed, press to mute all audio (AM/FM/AUX/USB/Bluetooth®)</li> </ul>	<ul style="list-style-type: none"> <li>• Press and hold to access the <b>USB: Play options</b> menu (USB)</li> </ul>
	Day/ Night	<ul style="list-style-type: none"> <li>• Press to switch between Day/Night display settings</li> </ul>	<ul style="list-style-type: none"> <li>• Press and hold to access the <b>System Settings: Display</b> menu</li> </ul>	



## GENERAL CONTROLS



### Turning the Unit ON / OFF

1. Press **SOURCE** to turn the unit ON.
2. Press and hold **SOURCE** to turn the unit OFF.

### Selecting a Source

1. Press **SOURCE** to access the **SOURCE: Select** menu.
2. Rotate the **VOL/SEL** knob to highlight a desired source; press to select.

### Adjusting Volume

The **VOL/SEL** knob is designed to be used as a main volume controller, allowing easy adjustment of the audio levels, for all zones simultaneously or for each zone independently. Refer to **Audio Zone Setup** on pages 15-16 for more info.



1. Rotate the **VOL/SEL** knob clockwise/counter-clockwise to increase/decrease volume (this also displays the **Audio Zone Level** screen).

### Muting or Pausing Audio

1. Press **▶ ||** to mute/unmute audio (AM/FM) or pause/resume the current selection (USB/Bluetooth®).

## Tuner Operation

Tuning selections (AM/FM) can be made with the following controls:

	Forward	<b>Press to:</b> <ul style="list-style-type: none"><li>• Tune in the next frequency (AM/FM)</li></ul> <b>Press and hold to:</b> <ul style="list-style-type: none"><li>• Seek to the next channel (FM)</li><li>• Skip forward ten frequency steps (AM)</li></ul>
	Backward	<b>Press to:</b> <ul style="list-style-type: none"><li>• Tune in the previous frequency (AM/FM)</li></ul> <b>Press and hold to:</b> <ul style="list-style-type: none"><li>• Seek to the previous channel (FM)</li><li>• Skip backward ten frequency steps (AM)</li></ul>

## Favorites

18 of your preferred AM/FM stations may be stored as presets for quick tuning access.

### Storing a Favorite

1. While listening to a desired channel (AM/FM), press and hold ★ until the star icon turns solid.

### Tuning to a Favorite

1. Press ★ to viewed stored presets.
2. Rotate the **VOL/SEL** knob to highlight a desired preset; press to select.

### Moving or Deleting a Favorite

1. Press ★ to viewed stored presets.
2. Rotate the **VOL/SEL** knob clockwise to the **Favorites: Edit menu** and highlight a desired function; press to select.
3. Use the **VOL/SEL** knob to select the preset to be moved or deleted.



## Bluetooth® Audio

You may wirelessly stream audio from a Bluetooth® compatible device from up to 35 ft. away (11 m). Up to 8 devices can be paired to the MM50, but only one streaming device can connect at one time.

### Pairing a new device:

1. Press **SOURCE** on the MM50 to access the **SOURCE: Select** menu.
2. Rotate the **VOL/SEL** knob to highlight **Bluetooth®** and press to access the **Bluetooth: Main Menu**.
3. Rotate the **VOL/SEL** knob to highlight **Pair New Device** and press to select/enter **Bluetooth: Pairing Mode**.
3. Enable Bluetooth® on your streaming device and scan for nearby devices; select **JLA MM50** (or your custom name) from your list of available devices to connect.

Once connected, you may control your audio selections with the MM50 using the controls below or directly from your device:

	<b>Forward</b>	• Press to select the next track
	<b>Backward</b>	• Press to select the previous track
	<b>Mute/Pause/Resume</b>	• Press to pause or resume playing the current selection • When the <b>Audio Zone Levels</b> screen is displayed, press to mute audio

### Pairing additional devices:

1. Press **SOURCE** on the MM50 to access the **SOURCE: Select** menu.
2. Rotate the **VOL/SEL** knob to highlight **Bluetooth®** and press to access the **Bluetooth: Connect Paired Device** menu.
3. Rotate the **VOL/SEL** knob to highlight **Connect New Device**; press to enter Pairing Mode.
4. Enable Bluetooth® on your streaming device and scan for nearby devices; select **JLA MM50** (or your custom name) from your list of available devices to connect.





### Managing Bluetooth® Devices:

You may manage paired devices or add new devices from the **Bluetooth: Main Menu**. To access the **Bluetooth: Main Menu**, press  while in Bluetooth® mode; then use the **VOL/SEL** knob to make your selections.

## Connecting USB Devices

The USB port may be used to connect USB storage class devices (thumb drive, digital audio player, etc.). This USB connection also provides a 1A output for device charging. If this output is exceeded, an error message will display and the output will be disabled. Devices may be plugged directly into the USB port or use the JL Audio Combo 3.5 mm Audio Jack and 9 Wire USB Port for Panel-Mounting (XMD-USB/3.5MM-PNL). An appropriate USB cable for your device is required to make this input connection.

Once connected, press the **SOURCE** button and select **USB** from the **SOURCE: Select** menu to access the connected device with the following controls:

	<b>Forward</b>	<ul style="list-style-type: none"><li>• Press to select the next track</li><li>• Press and hold to fast-forward</li></ul>
	<b>Backward</b>	<ul style="list-style-type: none"><li>• Press to select the previous track</li><li>• Press and hold to fast-rewind</li></ul>
	<b>Mute/Pause/Resume</b>	<ul style="list-style-type: none"><li>• Press to pause or resume playing the current selection</li><li>• Press and hold to access Shuffle and Repeat options from the <b>USB: Play Options</b> menu</li><li>• When the <b>Audio Zone Levels</b> screen is displayed, press to mute audio. You may also press and hold <b>VOL/SEL</b> to mute audio.</li></ul>
	<b>Back/Menu</b>	<ul style="list-style-type: none"><li>• Press to access the <b>USB: Main Menu</b> options</li><li>• Press to go back or return to the Now Playing Screen</li></ul>





### **! IMPORTANT**

- Properly secure the connected device before driving to prevent damage from dropping or sudden acceleration/braking.
- Control, functionality and display may vary depending on the type of device connected.
- Connections to computers or portable hard drives are not supported.
- Connections via USB hubs are not supported.

## Connecting an iPhone®

An iPhone® may be connected to the USB port using an appropriate Lightning to USB cable (not included).

Once connected, press the **SOURCE** button and select **USB** from the **SOURCE: Select** menu to access the connected device with the following controls:

	<b>Forward</b>	<ul style="list-style-type: none"> <li>• Press to select the next track</li> <li>• Press and hold to fast-forward</li> </ul>
	<b>Backward</b>	<ul style="list-style-type: none"> <li>• Press to select the previous track</li> <li>• Press and hold to fast-rewind</li> </ul>
	<b>Mute/Pause/Resume</b>	<ul style="list-style-type: none"> <li>• Press to pause or resume playing the current selection</li> <li>• Press and hold to access Shuffle and Repeat options from the <b>USB: Play Options</b> menu</li> <li>• When the <b>Audio Zone Levels</b> screen is displayed, press to mute audio. You may also press and hold <b>VOL/SEL</b> to mute audio.</li> </ul>
<b>VOL/SEL (Knob)</b>	<b>Volume/Select</b>	<ul style="list-style-type: none"> <li>• When the <b>Audio Zone Levels</b> screen is displayed, press and hold to mute audio</li> </ul>
	<b>Back/Menu</b>	<ul style="list-style-type: none"> <li>• Press to access the <b>USB: Main Menu</b> options</li> <li>• Press to go back or return to the Now Playing Screen</li> </ul>
Apple compatibility: iPhone® 5 or beyond		

### ! IMPORTANT

- Properly secure the connected device before driving to prevent damage from dropping or sudden acceleration/braking.
- Control, functionality and display may vary depending on the model and version of iPhone® connected.
- When connected via the USB port, make sure to unpair or disable the Bluetooth® connection to avoid possible playback conflicts.
- If you experience abnormal performance during operation, disconnect the iPhone® and check its condition. Restart your iPhone® if performance does not improve.
- “Made for iPhone” means that an electronic accessory has been designed to connect specifically to an iPhone® and has been certified by the developer to meet Apple performance standards. Apple is not responsible for the operation of this device or its compliance with safety and regulatory standards. Please note that the use of this accessory with an iPhone® may affect wireless performance.
- iPhone®, Lightning and all related marks and logos are trademarks of Apple Inc., registered in the U.S. and other countries.

## System Settings Main Menu

This menu allows access the main operational settings and features of your MM50. Refer to the table below for available settings and functionality.

1. Press and hold  to access the **System Settings: Main Menu**.
2. Turn the **VOL/SEL** knob to highlight one of the menu settings listed in the table below; press to select.
3. Use the **VOL/SEL** knob to make selections.

Setting	Function
Name this Device	Create a custom name to be displayed on connected Bluetooth® devices and NMEA 2000® networks
Audio Zone Setup	Configure settings for each set of audio zone outputs (see pages 15-16 for more info).
AUX Input Sensitivity	Configure the AUX input sensitivity: 2V or 1V RMS (default)
Diagnostic	Displays serial number, hardware and software version info
Display	Configures display and brightness settings
Low Voltage Alert	Notifies of low supply voltage conditions (see below for more info)
Scrolling Text	Enables continuous scrolling of available RDS/track text info
Tuner Region	Configures AM/FM tuner range/scale for a specific region

## Low Voltage Alert

This built-in alert notifies when the +12VDC supply voltage drops below 10 volts. If triggered, the unit will enter Safe Mode and mute the audio output. A warning will also display on-screen with instructions to turn the unit off until normal operating voltage is restored.

1. Press and hold  to access the **System Settings: Main Menu**.
2. Turn the **VOL/SEL** knob to **Low Voltage Alert** and press to enter.
3. Turn the **VOL/SEL** knob to select **ON** or **OFF** and press to enter.

## Audio Zone Setup

The MM50 includes two sets of line-level RCA outputs for its main audio zones, plus a dedicated set of subwoofer zone outputs, to send audio signals to aftermarket amplifiers/equipment. A built-in four channel amplifier is also onboard and delivers 100 watts of audio output power (4 x 25W RMS) from the main zones.

Both Zone 1 and 2 audio output types (speaker and line-level) deliver high-quality, full-range audio, while the subwoofer outputs are equipped with a 500 Hz low-pass filter.

The functionality of each zone is configurable via the **Audio Zone Setup** menu, allowing you to customize the listening experience for your vessel and audio system.

Access the **Audio Zone Setup** menu to configure the functionality of each zone.



1. Press and hold  to access the **System Settings: Main Menu**.
2. Press the **VOL/SEL** knob to select **Audio Zone Setup**.
3. Use the **VOL/SEL** knob to make selections.

Refer to the table below and the following page for each zone's available settings and functionality.

Zone	Menu	Setting 1	Setting 2
Z1: (ZONE 1) Z2: (ZONE 2) (configures line-level RCA and speaker-level outputs)	Level Control Mode	Variable (default)	
		Fixed	4V RMS Max (default) 2V RMS Max 1V RMS Max
		Off	
	Max Volume Limit	Set Volume Limit	
	Rename Zone	Bow, Bridge, Cabin, Cockpit, Galley, Helm, Stateroom 1, Stateroom 2, Tower, Transom	
		Custom Name	Alphanumeric Input
		Factory Default	
	Tone Control Mode (ZONE 2 only)	Same as Z1	
		Independent Tone Control	
SUB	Level Control Mode	Linked with Z1	
		Linked with Z2	
		Off	
	Tone Control Mode	Linked with Z1	
Linked with Z2			

Option	Setting	Function
Level Control Mode	Variable	Simultaneous adjustment of all zones, with independent control of each zone's relative offset level. The offset level of volume between each zone is easily adjustable, allowing you to create a customized level controller, specific for your vessel's layout and audio system design. To change the offset level of a zone, press the <b>VOL/SEL</b> knob to highlight a zone, then rotate to change its offset level.
	Fixed	The output level of the selected zone will be fixed, limited to a specific output voltage (not affected by the volume control). The output voltage of the line-level RCA outputs can be set to 4V (default), 2V or 1V RMS. <b>Note: Do not select this setting for a zone when using its speaker outputs.</b>
	Off	Disables the output level of the selected zone.
Tone Control Mode	Same as Z1	The tone controls are linked to and controlled by Zone 1.
	Independent Tone Control	The tone controls are separate with independent adjustments that can be accessed from the <b>Audio Zone Tone &amp; Balance</b> menu.
Rename Zone	This feature lets you assign a custom name for each zone or select from a preset list of vessel location names.	
Max Volume Limit	This feature allows you to set a fixed, maximum allowable volume limit for each zone.	

## Tone Control Mode

To access the **Tone, Balance & Crossover** menu, press  from any Now Playing Screen. Use the **VOL/SEL** knob to highlight a zone, then press to access its tone, balance & crossover controls; use the **VOL/SEL** knob to make adjustments. The tone controls of any zone with a  (chain link icon) will be linked to and controlled by Zone 1. Tone control settings include:

Menu	Setting
Tone & Balance	Treble, Midrange, Bass & Balance
HP Crossover (Z1 & Z2 only)	Off (default), 60 Hz, 80 Hz, 100 Hz & 150 Hz



### Optional Remote Controllers

Two control options are available for your MediaMaster® (each sold separately) using the **REMOTE** connection. Each connect directly using MediaMaster® controller cables and splitters (sold separately). Refer to the supplied Owner's Manual for specific installation and operations instructions.



### MMR-20-BE Wired Remote Controller

Adds water-resistant (IP67 rated) control functionality from auxiliary locations, such as separate audio zone locations positioned throughout a vessel. Up to three MMR-20-BE remotes may be connected to a single MediaMaster® at a maximum distance of 75 ft. Remotes connect directly using MediaMaster® controller cables and splitters (sold separately).



### MMR-10W Wireless Remote Controller

Adds handheld, long-range control from up to 150 ft. (45m) away. Floating, key fob style transmitter is water resistant (IP67 rated) and designed to go wherever the action is, on or in the water. Additional transmitters (up to ten) can be programmed to the hideaway receiver module. Includes a versatile mounting cradle and lanyard for convenient, on-the-go functionality.

### Optional NMEA 2000® Control Options

The MM50 is equipped with a NMEA 2000® connector (Micro-C) to interface directly with NMEA 2000® networks or the MMR-40 NMEA 2000® Network Controller.

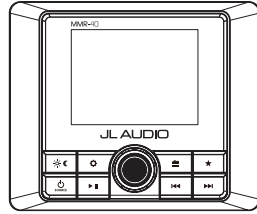

### MMR-40 NMEA 2000® Network Controller

Connects to NMEA 2000® vessel networks to deliver full MM50 display and control functionality using applicable NMEA 2000® cables and connectors (sold separately). Refer to the supplied Owner's Manual for specific installation and operations instructions.



### NMEA 2000® Connection

Connects to NMEA 2000® vessel networks with applicable NMEA 2000® cables and connectors (sold separately), permitting compatible multi-function displays (MFD) to control your MM50. NMEA 2000® functionality requires compatible NMEA 2000® entertainment protocols (PGN) and may require a software upgrade to connected MFD devices. Refer to your MFD's manufacturer for device compatibility info.

## Troubleshooting

Problem	Possible Cause	Possible Solution
Unit doesn't turn on	Faulty fuse	Remove fuse and check with continuity meter. Replace if necessary.
	Poor connection integrity	Check "Ground" and "+12VDC" connections for pinched wires; ensure tight connections.
No or low sound from a specific zone or all zones	Mute or Pause is on	Press <b>II</b> or press and hold the <b>VOL/SEL</b> knob from the <b>Audio Zone Levels</b> screen to verify that Mute is not on.
	Volume or zone level is turned down or disabled	Check <b>Audio Zone Levels</b> screen or <b>Audio Zone Setup</b> menu settings
Amps not turning on	Poor connection integrity	Check "Amp Turn-On" connections for pinched wires; ensure tight connections.
No or poor tuner reception	Poor connection integrity	Check antenna cable for pinched wires; ensure tight connections.
USB connection not working/charging	Poor connection integrity	Check USB cable for pinched wires; ensure tight connections.

NMEA®, NMEA 2000® and the NMEA 2000 logo are registered trademarks of the National Marine Electronics Association. The Bluetooth® word mark and logos are registered trademarks owned by Bluetooth SIG, Inc. iPhone® and Lightning are registered trademarks of Apple Inc. Use of all trademarks by JL Audio is under license.

## Specifications

Electrical Specifications	
Operating Voltage	14.4V DC (10.4V – 15.8V)
Current Draw / Fuse Value	15 A (max) / 100 mA (standby) / 15 A
NMEA 2000® LEN	1 (Micro-C connector)
Operating Temp Range	-4 F to +158 F (-20 C to +70 C)
Display Size / Type / Resolution	2.8-inch / TFT LCD backlitged / 320 x 240
Tuner	
FM Tuner with RDS	87.5 MHz to 107.9 MHz (0.1 MHz step)
AM Tuner	530 kHz to 1710 kHz (10 kHz step)
Favorites	18 presets across all bands
Bluetooth®	
Profile	A2DP v1.2, AVRCP v1.4
Core Specification / Codec	Version 2.1 + EDR / SBC
Connection Range	Up to 35 ft / 11 m
USB	
Interface	USB 2.0
Supported Audio Formats	MP3, WAV, WMA
Apple Compatibility	iPhone 5 or beyond
Maximum Current Output	2.1 A
Preamp Audio Outputs/Inputs	
Output Channels	Zones 1&2: Two stereo pairs of RCA plugs (4V RMS) Sub: One mono pair of RCA plugs (4V RMS)
Output Zone Configuration	Zones 1&2: Variable, Fixed or Off Sub: 500 Hz Low-Pass only
Maximum Output Voltage	Variable: 4V RMS Fixed: Selectable 4V/2V/1V RMS
Output Impedance	220 ohm
Input Channels	1 stereo pair of RCA plugs (2V/1V RMS Input Sensitivity)
Amplified Audio Outputs	
Rated RMS Power @ 14.4V	25W x 4 @ 4 Ω
Audio Control Options	
Tone & Balance	Treble, Midrange, Bass & Balance (all zones)
High-Pass Crossover	Off, 60 Hz, 80 Hz, 100 Hz & 150 Hz (Z1 & Z2 only)
Dimensions	
Unit W x H x D	4.65 in. x 3.74 in. x 3.15 in. (118 mm x 95 mm x 80 mm)
Mounting Hole W x H	3.74 in. x 3.12 in. (95 mm x 80 mm)

### **Limited Warranty – Electronics (USA)**

JL Audio warrants this product to be free of defects in materials and workmanship for a period of **two (2) years** from the original date of purchase.

This warranty is not transferable and applies only to the original purchaser from an authorized JL Audio dealer. Should service be necessary under this warranty for any reason due to manufacturing defect or malfunction, JL Audio will (at its discretion), repair or replace the defective product with new or remanufactured product at no charge. Damage caused by the following is not covered under warranty: accident, misuse, abuse, product modification or neglect, failure to follow installation instructions, unauthorized repair attempts, misrepresentations by the seller. This warranty does not cover incidental or consequential damages and does not cover the cost of removing or reinstalling the unit(s). Cosmetic damage due to accident or normal wear and tear is not covered under warranty.

### **Warranty is void if the product's serial number has been removed or defaced.**

Any applicable implied warranties are limited in duration to the period of the express warranty as provided herein beginning with the date of the original purchase at retail, and no warranties, whether express or implied, shall apply to this product thereafter. Some states do not allow limitations on implied warranties, therefore these exclusions may not apply to you. This warranty gives you specific legal rights, and you may also have other rights, which vary from state to state.

### **If you need service on your JL AUDIO product:**

All warranty returns should be sent to JL Audio 's Electronics Service Facility freight-prepaid through an authorized JL Audio dealer and must be accompanied by proof of purchase (a copy of the original sales receipt). Direct returns from consumers or non-authorized dealers will be refused unless specifically authorized by JL Audio with a valid return authorization number. Warranty expiration on products returned without proof of purchase will be determined from the manufacturing date code. Coverage may be invalidated as this date is previous to purchase date. Non-defective items received will be returned freight-collect. Customer is responsible for shipping charges and insurance in sending the product to JL Audio. Freight damage on returns is not covered under warranty.

### **For Service Information in the U.S.A. please call**

#### **JL Audio Customer Service:**

(954) 443-1100

9:00 AM – 5:30 PM (Eastern Time Zone)

#### **JL Audio, Inc.**

10369 North Commerce Pkwy.

Miramar, FL 33025

(Do not send product for repair to this address)

### **International Warranties:**

Products purchased outside the United States of America are covered only by that country's distributor and not by JL Audio, Inc.