









# ASSEMBLY INSTRUCTION

Item#:5107-10458 Writing Desk 60in

**\*\* Please make sure you have all parts indicated below prior to assembly.  
This unit is heavy and can best be assembled with the help of two or more persons.**

NO.	HARDWARE LIST		Q'TY
A		ALLEN WRENCH	1
B		BOLT	8
C		LOCK WASHER	8
D		FLAT WASHER	8
E		NUT	2
F		SPANNER WRENCH	1
G		CURVED WASHER	2
H		FULL THREADED BOLT	2

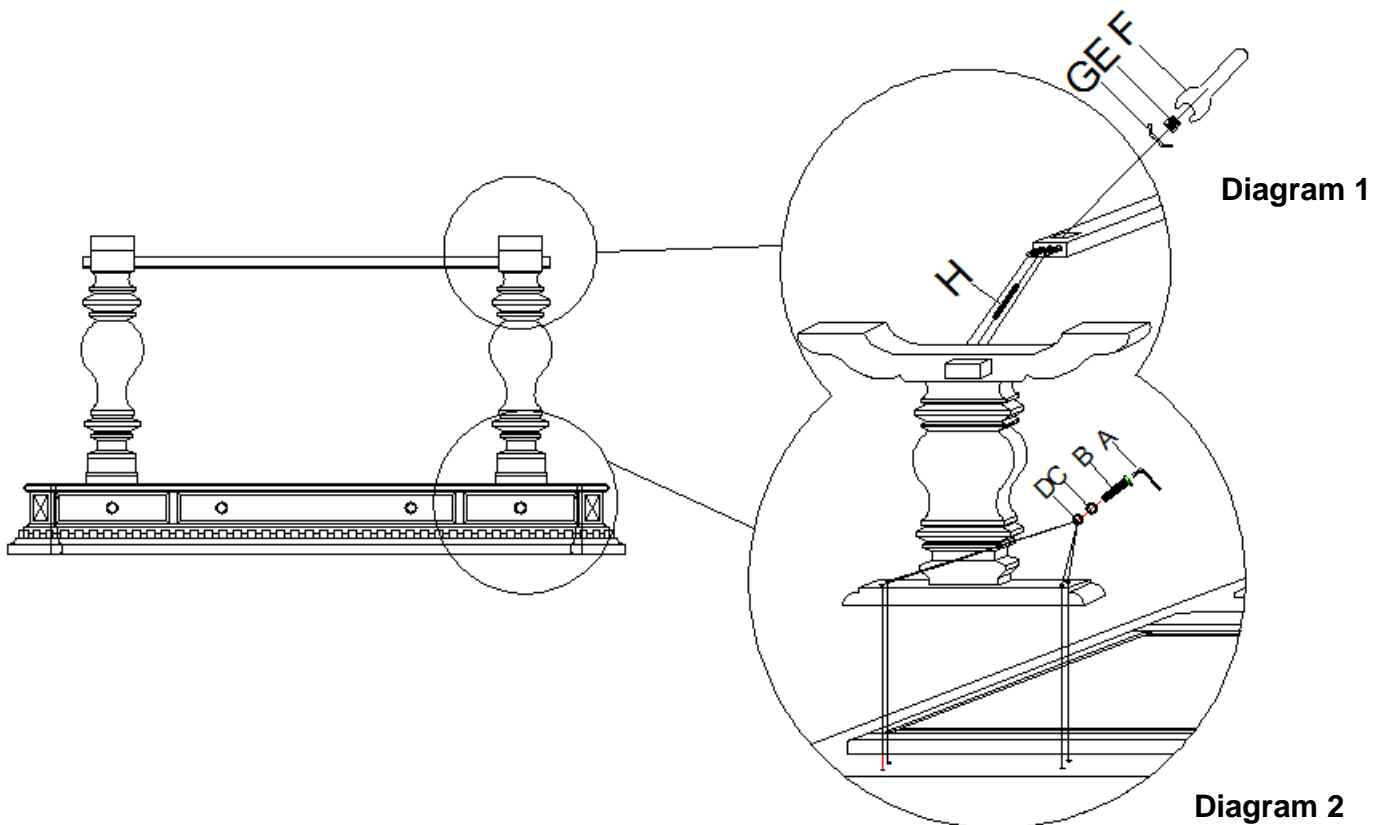
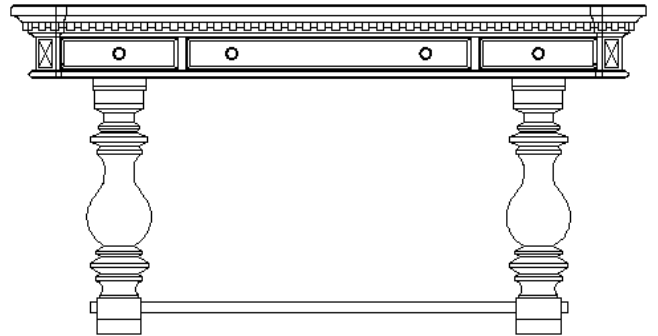

**Assembly Steps:**

1. Place writing desk top upside down on a soft surface to prevent from scratching.
2. Place the bottom rail on the bases, insert 2 full threaded bolts (H) through the hole on ends of the rail into the hole on base by using 2 nuts (E), 2 curved washers (G), secure by turning nut (E) with spanner (F) in a clockwise direction tightly.(See diagram 1).
3. Attach bases to the top, using 8 bolts (B), 8 lock washers (C), 8 flat washers (D), secure by turning with allen wench (A) in a clockwise direction tightly. (See diagram 2)
4. Turn the writing desk upright.

***Cleaning Instruction: Clean finished parts with a damp cloth using a mild dishwashing liquid and water solution. Polish the finish with soft cloth and an industry recognized furniture polish.***