

# UVB36SK

## Universal 36" Telescopic Downdraft System

### DIMENSIONS AND INSTALLATION INFORMATION (IN INCHES)

**NOTE:** Telescopic downdraft vents are not recommended to be installed with cooktops that are flush mounted.

Approved for use with the following GE Profile™ and GE® Series cooktops—36" electric models, 36" gas sealed burner models and 36" induction models.

### NOT APPROVED FOR USE WITH STANDARD BURNER GAS COOKTOPS.

**NOTE:** The cooktop must be at least 26" deep with a flat surface area of 23-1/2" or more, front to back. In addition, other clearances to the front edge of the countertop must be considered.

**NOTE:** Dimensions shown are for reference only. Before cutting out countertop, refer to instructions packed with downdraft and cooktop.

**NOTE:** Installation on cabinets/countertops against the wall will not be possible in most applications. Against the wall installations are limited to dimension requirements. Refer to installation instructions packed with product for further details.

### JXRB67 INDOOR REMOTE ACCESSORY.

Optional accessory may be ordered for installation of motor and blower assembly in an indoor remote location.

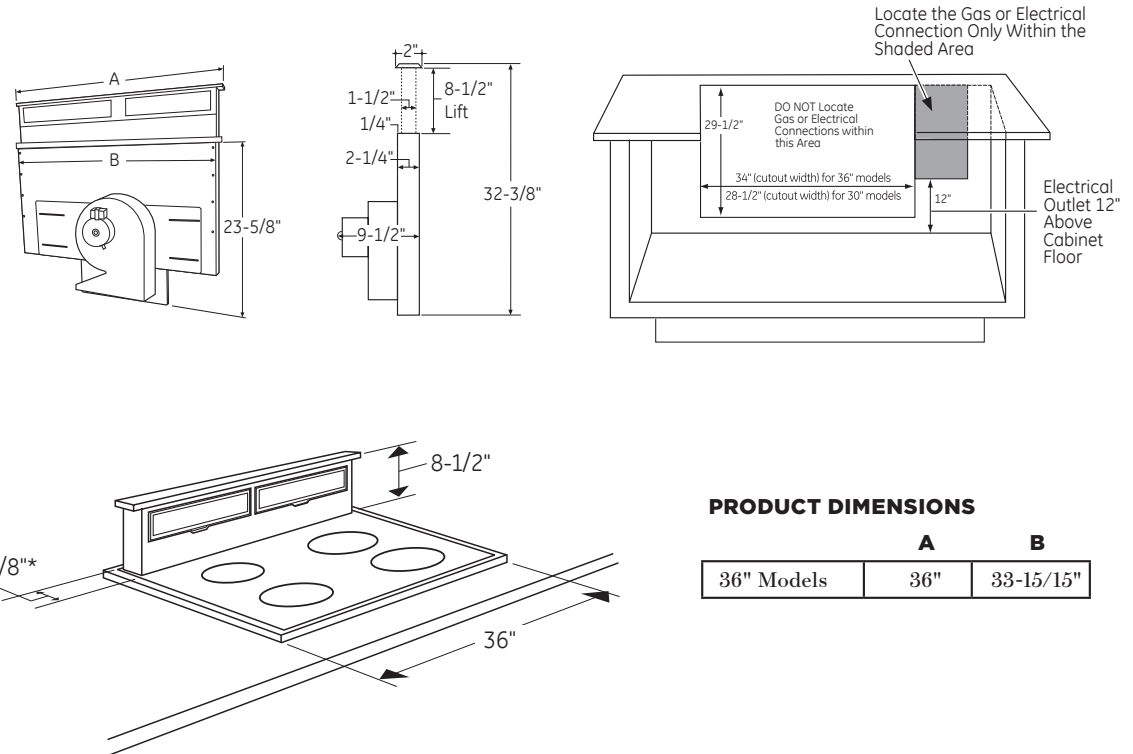

### PRODUCT DIMENSIONS

	A	B
36" Models	36"	33-15/16"



GE APPLIANCES

For answers to your Monogram, GE Profile™ Series or GE® Series appliance questions, visit our website at [geappliances.com](http://geappliances.com) or call GE Answer Center® service, 800.626.2000.











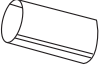



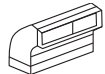

Specification Created 10/15

# UVB36SK

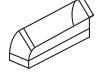
## Universal 36" Telescopic Downdraft System

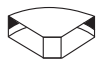
### VENTING DUCT INFORMATION

DUCT PIECES	EQUIVALENT LENGTH*	DUCT PIECES	EQUIVALENT LENGTH*
 6" ROUND STRAIGHT	1 ft. (per foot length)	 3-1/4" X 10" TO 6" ROUND TRANSITION	2 ft.
 3-1/4" X 10" STRAIGHT	1 ft. (per foot length)	 6" ROUND TO 3-1/4" X 10" TRANSITIONS 90° ELBOW	4 ft.
 6" 90° ELBOW	12 ft.	 3-1/4" X 10" TO 6" ROUND TRANSITION 90° ELBOW	4 ft.
 6" 45° ELBOW	7 ft.	 6" ROUND WALL CAP WITH DAMPER	24 ft.
 3-1/4" X 10" 90° ELBOW	14 ft.	 3-1/4" X 10" WALL CAP WITH DAMPER	24 ft.
 3-1/4" X 10" 45° ELBOW	12 ft.	 6" ROUND ROOF CAP	33 ft.
 3-1/4" X 10" 45° ELBOW	33 ft.	<b>SHOULD NOT EXCEED 100 EQUIVALENT FT.</b> *Equivalent length of duct pieces are based on actual test conducted by GE Evaluation Engineering and reflect requirements for good venting performance with a downdraft system rated at 390 CFM	
 6" ROUND TO 3-1/4" X 10" TRANSITIONS	2 ft.		

### PLAN THE DUCTWORK

1. This downdraft blower system is designed for use with 3-1/4" x 10" ductwork (can be transitioned to 6" round). Two different discharge directions are available with side-to-side adjustment for the accurate alignment of ductwork.
2. For best performance: choose the ducting option which allows the shortest length of ductwork and a minimum number of elbows and transitions. Check location of floor joists, wall joists, wall studs, electrical wiring or plumbing for possible interference.

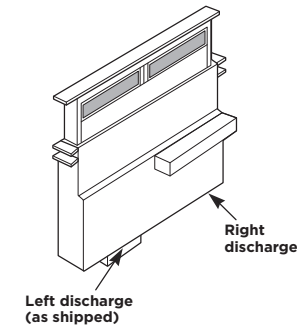

### STEPS TO DETERMINE FLEXIBLE DUCTING'S EQUIVALENT LENGTH

1. Measure the actual amount of offset (Maximum 3" recommended). The effect upon airflow is dependent upon the amount of offset.
2. Calculate the equivalent ducting allowances using:  
 $(\text{__in. offset}) \times (14 \text{ ft. per inch}) = \text{__ft. equivalent length.}$
3. Ensure that the total equivalent length of ducting does not exceed the maximum recommendation of 100 feet.



GE APPLIANCES

For answers to your Monogram, GE Profile™ Series or GE® Series appliance questions, visit our website at [geappliances.com](http://geappliances.com) or call GE Answer Center® service, 800.626.2000.

# UVB36SK

## *Universal 36" Telescopic Downdraft System*

### **FEATURES AND BENEFITS**

370-CFM venting system – Effectively removes smoke, grease, odor and moisture

Four-speed fan control – Helps draw smoke, grease, odors and moisture out of the kitchen air

Telescopic hood – Raises over cooktop surface and retracts when not in use

Separate remote raise/lower switch

Model UVB36SKBB – Black on Black

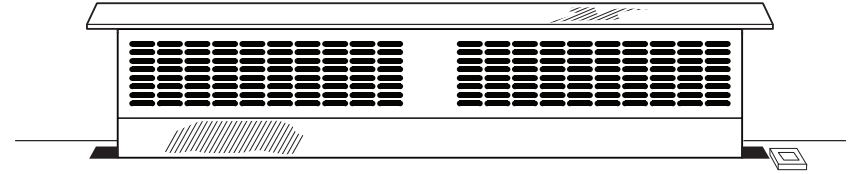

**GE APPLIANCES**