

CG304P/S



FEATURES

Dual-stacked burners go from 18,000 Btu down to a mere breath of flame

Lower tier of dual-stacked burner lets you simmer and melt

Continuous cast-iron grates for easy movement of pots and pans

Easy-clean seamless burner pan

Rigorously tested in our U.S. manufacturing facilities for decades of use

Exceptional 24/7 support from our Customer Care team in Madison

Individual spark ignition system

Signature red control knobs (black or stainless also available)

ACCESSORIES

Signature red, black or stainless steel control knobs

Two-burner wok grate—wok covers one burner only

High altitude conversion kit

Accessories available through an authorized Sub-Zero dealer.
For local dealer information, visit subzero-wolf.com/locator.



KNOB OPTIONS



TOP CONFIGURATION

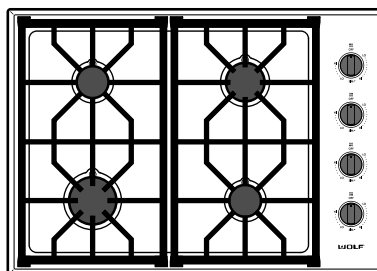

COOKTOP SPECIFICATIONS

- 2 - 9,200 Btu Burner
- 1 - 12,000 Btu Burner
- 1 - 18,000 Btu Burner

PRODUCT SPECIFICATIONS

Model	CG304P/S
Dimensions	30"W x 4"H x 21"D
Weight	50 lb
Electrical Supply	120 VAC, 60 Hz
Electrical Service	15 amp dedicated circuit
Gas Supply	3/4" rigid pipe
Gas Inlet	1/2" NPT male
Power Cord Length	6 feet

ELECTRICAL AND GAS

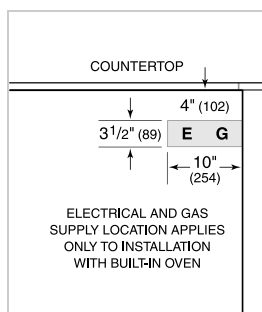

DIMENSIONS

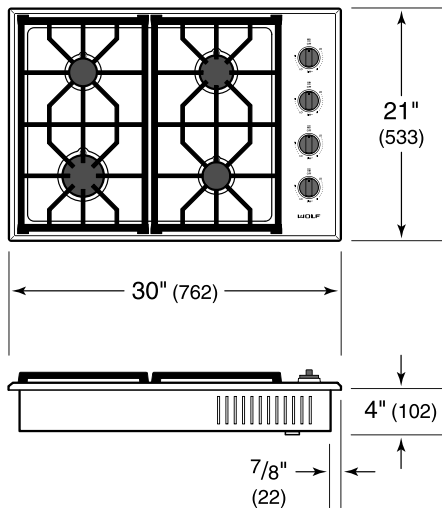

STANDARD INSTALLATION

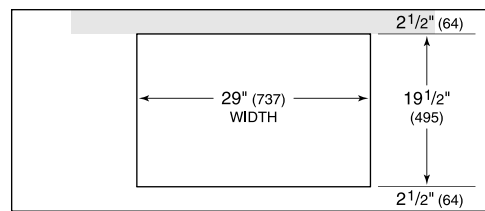

COUNTERTOP CUT-OUT

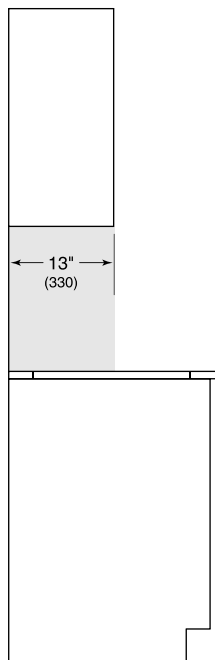

SIDE VIEW

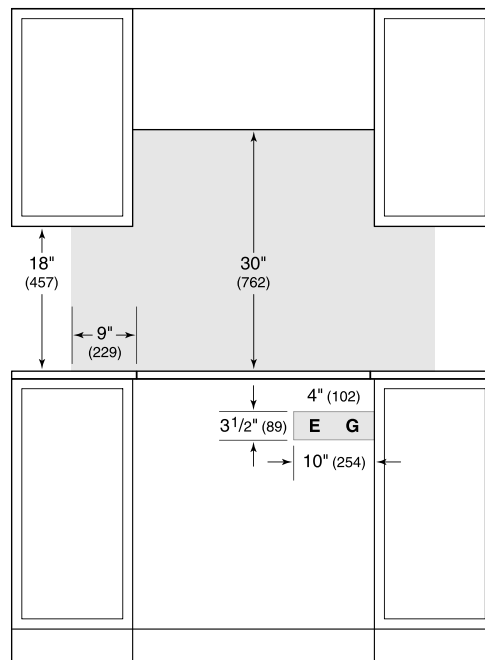

FRONT VIEW

NOTE: Shaded area above countertop indicates minimum clearance to combustible surfaces, combustible materials cannot be located within this area. Electrical and gas supply location only applies to installations with built-in oven.