

Component List

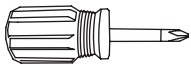

A - Phillips Screwdriver
x 1

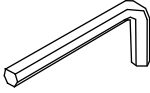

B - Allen Wrench x 1

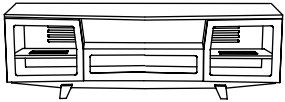

C - Assembled Cabinet
x 1

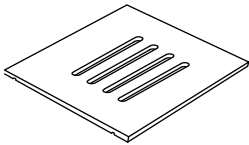

D - Adjustable Shelf x 2

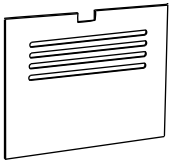

E - Back Panel x 2

Marina[®] is engineered for easy assembly. Carefully follow this procedure to prevent any damage.

Placement and Maintenance

Marina[®] is designed for indoor use on level floors. Clean glass with glass cleaner; steel parts and wood veneer with a moist cloth.

Step 1

Unpack and Identify

Unpack and identify the components at left. The assembly workspace should be a non-marring surface such as carpet. For missing hardware pieces, please contact BDI Customer Service at customerservice@bdiusa.com. For all other concerns, please contact your BDI Retailer.

Step 2

Leveling and Shelf Adjustment

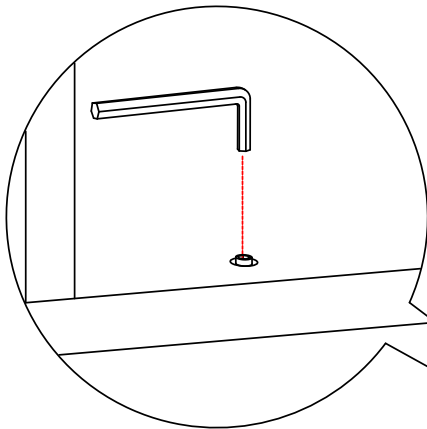

The adjustable leveler glides on the bottom, mid section of the cabinet are accessible from inside the cabinet using the **Allen Wrench (B)**.

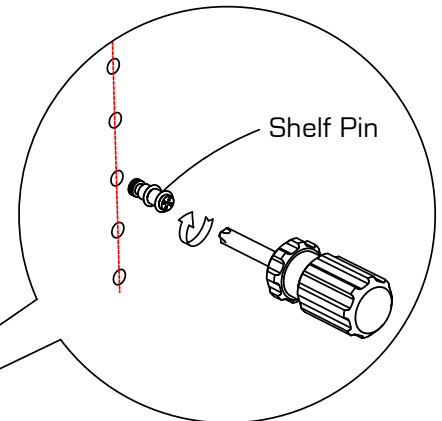
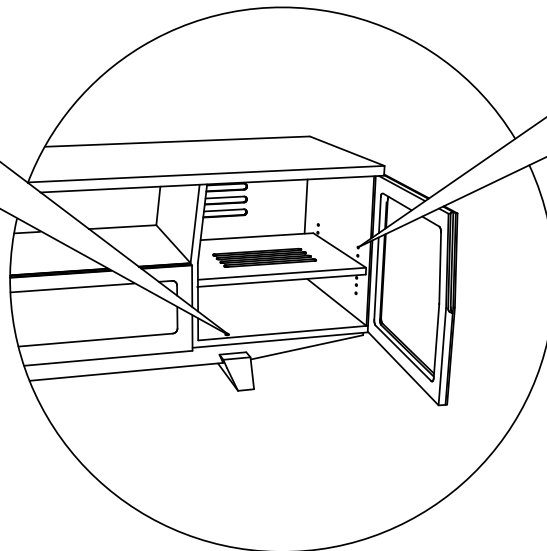

The shelf pins located inside the left and right cabinet space may be repositioned, allowing you to raise or lower the shelf to the desired level.

For more information about the adjustable levelers and troubleshooting, be sure to check out "Fine tuning your new BDI Marina Home Theater Furniture" at the end of these instructions.

Step 4

Install **Back Panel (E)** to the rear side of cabinet in the pre-determined slots. Velcro straps are included as wire management for your convenience.

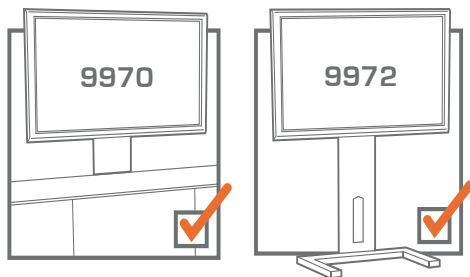
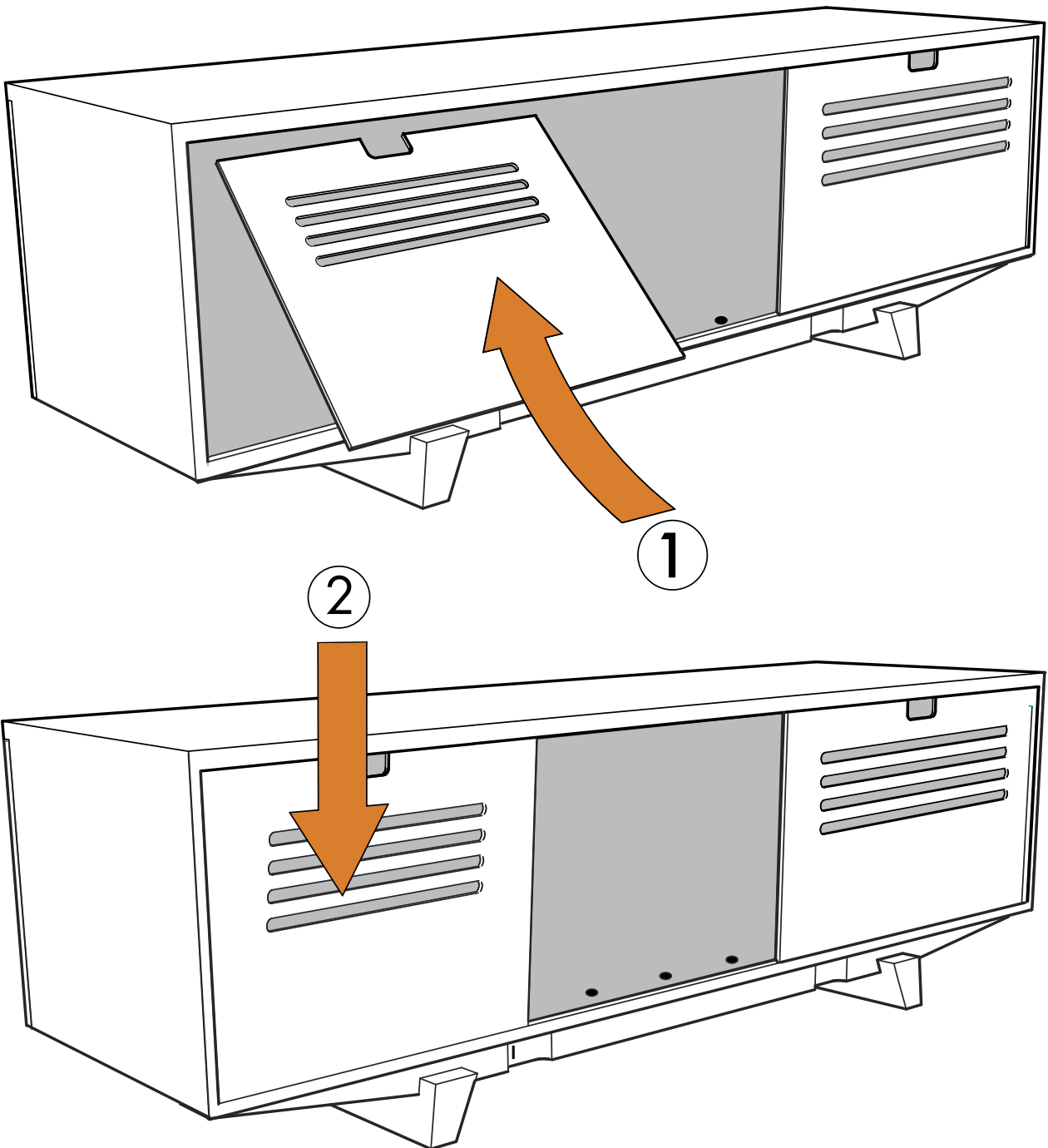

Optional Flat Panel TV Mount

This BDI cabinet is compatible with both the **BDI's Cabinet Flat-Panel TV Mount #9970** and the **#9972 Freestanding Flat-Panel TV Mount (sold separately)**, with the following features:

- accommodates most TVs up to 60"
- swivel allows for rotating for optimal viewing
- allows adjustable TV mounting height
- accepts and route cables to and from the TV

For more information, visit www.bdiusa.com

Thank you for choosing BDI.

Your BDI home theater cabinet is engineered to include a range of adjustments. Please read and retain this guide so that you can fully enjoy the look and use of your cabinet for years to come.

Unless manual leveling is required or you wish to prevent the cabinet from rolling, you may prefer to keep the cabinet's levelers up and off the floor. This allows easier cabinet movement for greater access to rear panels and wire-management, and permits easier cleaning/vacuuming underneath the cabinet.

By following the steps in this guide, you can be sure that your BDI cabinet is in optimum tune and adjustment. If you need additional assistance, contact BDI at customerservice@bdiusa.com.

Fine tuning your BDI Home Theater Furniture

After unpacking and assembling your cabinet, inspect it to be sure that it is sitting level on the floor, that all doors appear level, and that they open and close freely without rubbing or binding.

Due to uneven floors or perhaps gentle jostling during shipment, your BDI cabinet may not appear to be in perfect alignment when first assembled or when loaded with heavier electronic equipment. Such alignment issues are usually minimized or eliminated with only a few minor adjustments.

STEP 1 - Level your Marina unit

Levelers are integrated into each leg assembly and are accessed from inside the cabinet. If your floor is uneven, you may extend one or more levelers (with the provided **Allen Wrench (B)**) to attain a level, stable cabinet placement. Turning the leveler clockwise will extend the leveler; turning it counter-clockwise will retract it. (Refer to diagram in Step 2)

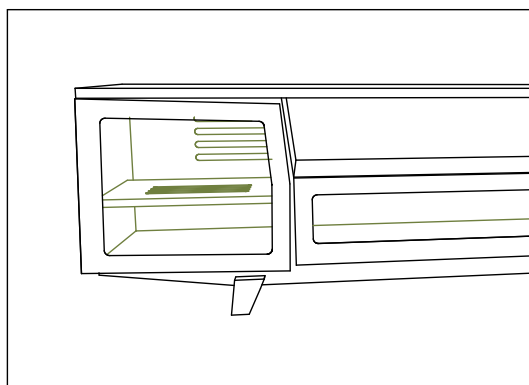

INCORRECT!
Door is out of alignment with the rest of the unit.

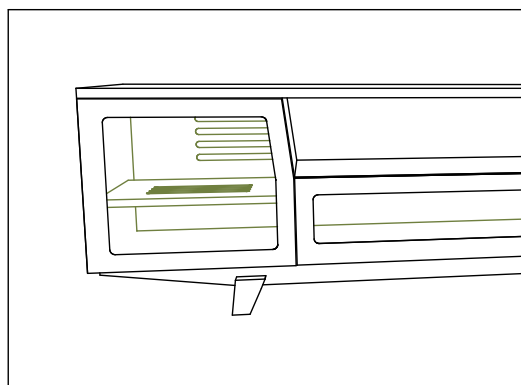

CORRECT!
Door is sitting squarely and evenly spaced on tops and sides.

STEP 2 - Adjust Door Hinges (if needed)

The doors on your cabinet should be evenly spaced and the doors should open and close freely without rubbing against the door frame.

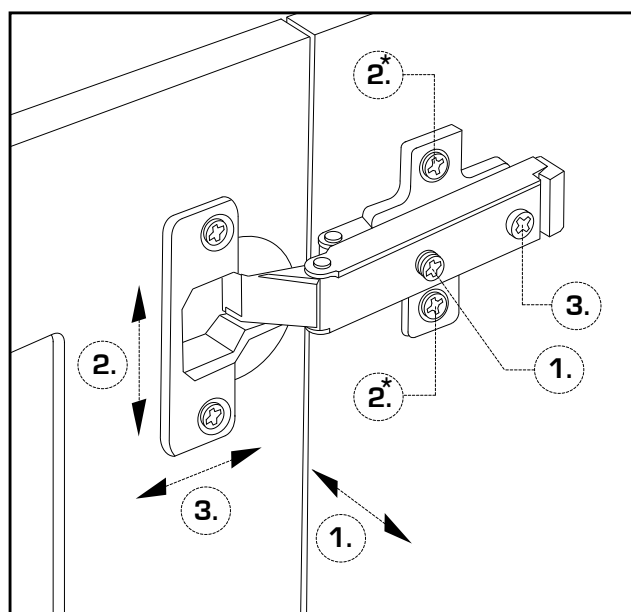

If the cabinet's doors appear out of alignment, this condition can be corrected with minor adjustment to the European hinges on each door.

Because these hinges are infinitely adjustable, adjusting one hinge element can sometimes cause the need for adjustments to other elements. But with a few adjustments, you can modify the orientation of the cabinet doors to make sure that they hang perfectly within your cabinet.

Use a Phillips screwdriver to adjust the door hinges:

- By adjusting **Screw 1**, the door will move LEFT or RIGHT within the frame. Make minor adjustments at both top and bottom hinges for best results.
- By adjusting **Screw(s) 2**, the door will move UP or DOWN within the frame (the top and bottom hinges must be adjusted the same amount).
- By adjusting **Screw 3** the entire door will move IN or OUT, opening or closing the gap between the door frame and cabinet (this screw rarely needs adjustment).