

STREAM | jockey Satellite | Radio Products

Stream | jockey Power Pod™



Must Be Used with
STREAM | jockey
Satellite Radio Receiver—
(sold separately.)

Instruction Manual

Model XS028

To activate your Satellite Radio Receiver or for latest news and questions regarding SIRIUS® Satellite Radio service visit sirius.com or call 1-888-539-SIRIUS (7474).

For accessory & product information visit us at www.getxact.com.



SIRIUS
SATELLITE RADIO

KEEP ON LISTENING



This equipment has been tested and found to comply with the limits for a Class B digital device, pursuant to Part 15 of the FCC Rules. These limits are designed to provide reasonable protection against harmful interference in a residential installation. This equipment generates, uses, and can radiate radio frequency energy and, if not installed and used in accordance with the instructions, may cause harmful interference to radio communications. However, there is no guarantee that interference will not occur in a particular installation. If this equipment does cause harmful interference to radio or television reception, which can be determined by turning the equipment off and on, the user is encouraged to try to correct the interference by one or more of the following measures:

- Reorient or relocate the receiving antenna.
- Increase the separation between the equipment and receiver.
- Connect the equipment into an outlet on a circuit different from that to which the receiver is connected.
- Consult the dealer or an experienced radio/TV technician for help.

Changes or modifications not expressly approved by the Manufacturer for compliance could void the user's authority to operate the equipment.

COPYRIGHT / TRADEMARKS

No part of this publication may be reproduced, stored in a retrieval system, or transmitted in any form or by any means, whether electronic, mechanical, photocopying, recording or otherwise without the prior writing of the publisher.



© 2004 SIRIUS® Satellite Radio Inc. "SIRIUS" and the SIRIUS® dog logo are registered trademarks of SIRIUS® Satellite Radio Inc. To activate your Satellite Radio Receiver or for latest news and questions regarding SIRIUS® Satellite Radio service visit sirius.com or call 1-888-539-SIRIUS (7474).

SAFETY PRECAUTIONS



Cautions and Warnings

Follow these warnings and safety considerations, serious accidents and/or personal injury can be avoided:

1. Installation must be performed according to this user guide.
2. Do not install the Stream | jockey Power Pod™ in a position that obstructs viewing of any home entertainment component, such as Television, or stereo system indicators and displays.
3. Find a suitable location for your Stream | jockey Power Pod™. Do not install or place your Stream | jockey Power Pod™ on an inclined or unstable surface.
4. The installation and usage suggestions contained in this user guide are subject to any restrictions or limitations that may be imposed by applicable law. The purchaser should check applicable law for any restrictions or limitations before installing and/or operating this device.
5. Do not install or use your Stream | jockey Power Pod™ in locations exposed to direct sunlight, or in areas subject to extreme temperatures; do not operate the unit in moist areas, in rain, or in areas adjacent to water such as pools, hot tubs, etc.
6. When outdoors, position your Stream | jockey Power Pod™ antenna where there are no obvious satellite radio signal obstructions such as high terrain, trees, overhangs, etc.
7. When installed indoors, unplug the power adapter from the wall outlet when the Stream | jockey Power Pod™ is not to be used for an extended period of time. If battery is installed, turn off the power to prevent unintentional battery discharge, or remove the battery.
8. To avoid possible damage to the Stream | jockey Power Pod™, it is recommended that the battery pack be removed when the Stream | jockey Power Pod™ is not being used for an extended period of time.
9. By following these warnings and safety considerations, serious accidents and/or personal injury can be Avoided.



Danger

Be aware of the following precautions to prevent fire and avoid personal injury:

1. To avoid short circuits, never put or leave any metallic objects (coins, tools, etc.) inside the device.
2. If the device emits smoke or strange smells, turn the power off immediately and contact your dealer.
3. Do not drop the device or subject it to strong shocks.
4. When using the DC Power Adapter, make sure the power cable is not connected to the wall outlet until all connections have been made and verified. The power cable should be connected last.
5. Incorrect installation may cause damage to the system.

SAFETY PRECAUTIONS

Caution on the Battery Pack and Stream | jockey Power Pod™

1. To prevent accident from a short circuit, do not allow metal objects to come into contact with the battery contacts.
2. Keep the battery away from fire.
3. Never expose the battery pack to temperatures above 60°C (140°F), such as in a car parked in the sun.
4. Keep the battery pack dry.
5. Do not expose the battery pack and Stream | jockey Power Pod™ to any mechanical shock.
6. Do not disassemble nor modify the battery pack and the Stream | jockey Power Pod™.
7. Attach the battery pack to the Stream | jockey Power Pod™ securely.
8. The battery pack and Stream | jockey Power Pod™ is not resistant to water. Do not wet the battery pack or the Stream | jockey Power Pod™.
9. Unless you use the battery pack for a long period, store the battery pack after you charge it fully and use it completely once a year.
10. Store the battery pack in a cool, dry place.
11. The battery pack and the stream jockey power pod become warm during use. This is not a malfunction.
12. Always keep metal contacts clean.
13. Do not carry your Stream | jockey Power Pod™ by holding the battery pack. If you do so, the battery pack may detach from the Stream | jockey Power Pod™ unintentionally, by doing so may damage the Stream | jockey Power Pod™.
14. Discard "dead" batteries as soon as possible since a "dead" Battery is more likely to leak in the Stream | jockey Power Pod™ and damage it.
15. Dispose of the BATTERY in the proper manner, according to the federal, state, and local regulations that apply to your area.

INTRODUCTION

Product Overview

Thank you for purchasing this product! Your new Xact Stream | jockey Power Pod™ is specifically designed for the XTR1 Xact Stream | jockey SIRIUS® Radio. Best performance will be obtained with the unit stationary with a clear view of the sky. When used in a portable environment, satellite reception will vary depending on antenna orientation and local surroundings. The Stream | jockey Power Pod™ includes a rotating hinge mechanism so that the antenna can be locked in place for best performance. The unit will not be able receive the satellite signal without a clear view of the sky (i.e. in subways, tunnels, elevators, etc.).

Package Contents

Carefully unpack your kit box and ensure that you have the following items.

- Xact Stream | jockey Power Pod™
- 9V DC Power Adapter
- Earphones
- User's Guide

In the event that any item is missing or if you find any mismatch or damage, promptly contact your dealer.

Your Xact Stream | jockey Power Pod™ must be used in conjunction with The XTR1 Xact Stream | jockey SIRIUS® Radio. Please see these other available accessories below.

- | | |
|---|---------------------|
| • Xact Vehicle Kit: | Model Number XS021 |
| • Xact Home Kit: | Model Number XS022 |
| • Xact Universal Kit: | Model Number XS01UK |
| • Xact Sound Pad Portable Boom Box: | Model Number XS024 |
| • Xact Sound System Portable Boom Box: | Model Number XS025 |
| • Xact Sound System Deluxe Portable Boom Box: | Model Number XS027 |

The easiest way to activate your Satellite Radio Receiver is to log on to sirius.com. You may also call 1-888-539-SIRIUS (7474).

Stream | jockey Power Pod™

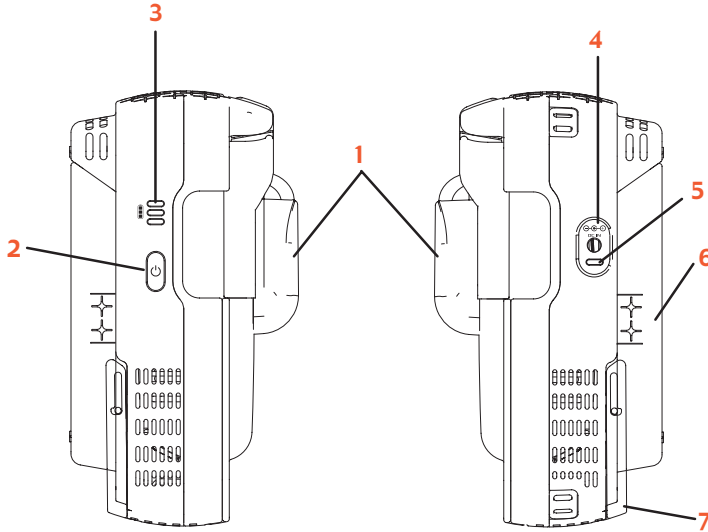

1. **Satellite Antenna:** A built-in rotating Satellite antenna.
2. **Battery Power Test Button:** Press this button to check the remaining charge capacity of the rechargeable battery pack.
3. **Battery Power Indicator:** The 3 color LED showing Red, Yellow, and Green.
Red = around 25% Capacity Left, Yellow = around 50% Capacity Left and
Green = around 100% Capacity.
4. **DC Power Jack:** Plug in only the supplied 9V DC Power Adapter to charge the battery pack.
5. **Charging Indicator:** Dual Color LED (Red = Charging, Green = Fully Charged)
6. **Rechargeable Battery Pack**
7. **Stand:** Allows you to stand the Stream | jockey Power Pod™ for ease of use.

POWER POD SETUP

To set up your Xact Stream | jockey Power Pod™

Place the Stream | jockey Satellite Receiver in the cradle as shown so that the guides are lined up with the Power Pod cradle. Then rotate the receiver forward to engage the connectors. The receiver will lock in place. Turn on the power by pressing the power button on the Stream | jockey Receiver.

1. PUSH RECEIVER ONTO CONNECTOR

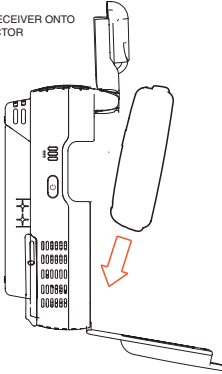

2. ROTATE RECEIVER AND CONNECTOR INTO POWER POD

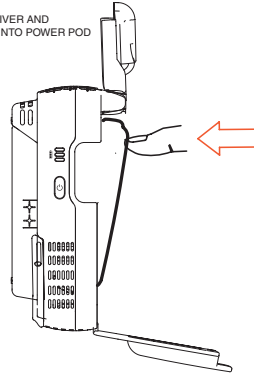

3. POWER POD LOCKS RECEIVER IN PLACE

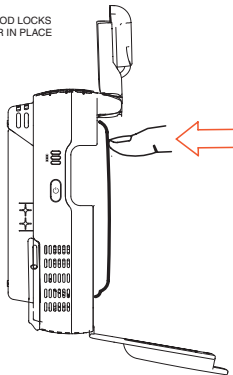

Installing the Xact Stream | jockey Power Pod™ Battery

Your Stream | jockey Power Pod™ is powered by a Lithium-Ion Battery (included). A fully charged Battery provides approximately 3 hours of listening time.

To install and/or replace the Battery:

Install the Lithium-Ion Battery provided in the Battery cavity located at the rear of the unit (see below). Be certain to follow the correct orientation in the compartment. A Battery installed incorrectly can prevent the unit from operating.

NOTE: If you install/replace the Battery and the LCD Screen remains blank for more than 3 seconds, press and hold the Power button for 1 second to activate the receiver.

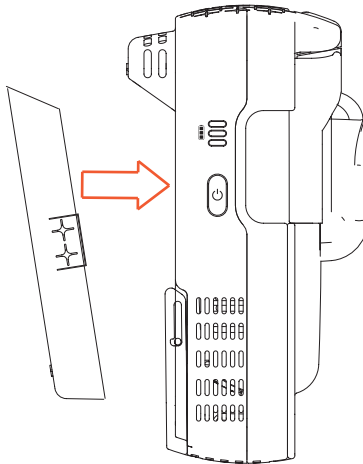

Charging the Xact Stream | jockey Power Pod™ Battery

Your Stream | jockey Power Pod™ comes with an AC/DC Adapter to charge your Lithium-Ion Battery.

To charge the Battery:

1. Connect the 9V AC/DC Power Adapter into an A/C wall outlet.
2. Insert the 9V AC/DC Power Adapter plug into the power jack located on the right side of the unit. The Red LED will come on indicating that the Battery is being charged and will turn Green when the battery is fully charged.
3. If the Red LED comes on and immediately goes off, either remove the Receiver or disconnect the Battery for a few seconds and reinstall. Charging will resume. The Red LED will come on and stay Red until the Stream | jockey Power Pod™ is fully charged. Once the Battery is fully charged the LED will turn to Green. A fully charged Battery provides approximately 3 hours of listening time.

NOTE: Charge the Battery

5 - 6 hours when the Receiver is not in use.

9 - 10 hours when the Receiver is in use.

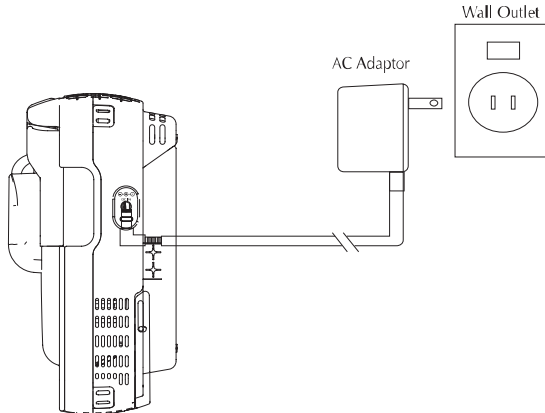

Battery Power Indicators

The Stream | jockey Power Pod™ has 3 color LED's, Green, Yellow and Red on the left side of the unit. These LED's indicate the level at which the Battery is charged. Press the Battery Power Test Button that is next to the LCD's to show the level at which the Battery is charged.



around 100% Capacity



around 50% Capacity Left



around 25% Capacity Left

When the Stream | jockey Power Pod™ is not being used, press and hold the Power button for 3 seconds to de-activate the Receiver.

When the Stream | jockey Power Pod™ is not being used for any length of time, conserve the Battery power by removing the Receiver from the Stream | jockey Power Pod™.

Xact Stream | jockey Earphones

Your Power Pod comes with a pair of complementary earphones.

To use the earphones:

Plug them in to the Headphones jack found on the Stream | jockey receiver, then place the earbuds in your ears as shown.



Warning: Listening to music at high volume over extended periods of time can damage your hearing.

Antenna Aiming feature found on the Stream | jockey receiver.

To access the Antenna Aiming Feature:

Press the **MENU** button on the Stream | jockey receiver's key pad. Press the **^** **CH** or **v** **CH** button to scroll to the Antenna Aiming selection and press **SELECT** button.

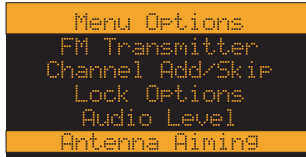

Upon entering this option, two 10-segment horizontal bar graphs are displayed with a (-) sign to the left and a (+) sign to the right. One is label "SAT" (satellite signal strength) and the other "TER" (terrestrial signal strength). The current setting is indicated on the bar graphs. Rotate the Antenna to receive greater antenna strength. (See SIRIUS® satellite map below).

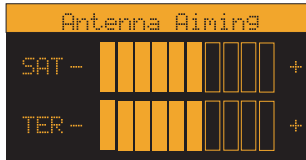

SIRIUS® Satellite Map

Due to the paths of SIRIUS® satellites over the US, the best location for the antenna in your home depends on where you live. Use the map below as a general placement guideline.

Area 1 : Place the antenna at an EAST - facing window.

Area 2 : Place the antenna OUTSIDE, away from any overhead obstructions.

Area 3 : Place the antenna at a NORTH WEST - or WEST - facing window.

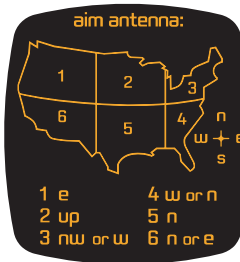

Area 4 : Place the antenna at a WEST - or NORTH - facing window.

Area 5 : Place the antenna at a NORTH - facing window.

Area 6 : Place the antenna at a NORTH - or EAST - facing window.

Signal Reception Guidelines

To get the best performance, the unit should be stationary with a clear view of the sky. When it is being carried or used in a moving vehicle, satellite reception will vary depending on antenna orientation and local surroundings. The Stream | jockey Power Pod™ includes a rotating hinge mechanism so that the antenna can be locked in place for best performance. The unit will not be able to receive the satellite signal in subways, tunnels, elevators, etc.

Recommended for Best Reception (with a clear view of the sky)

Beach

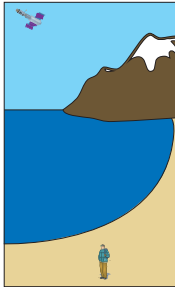

Office

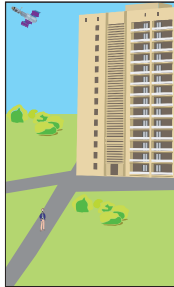

Park

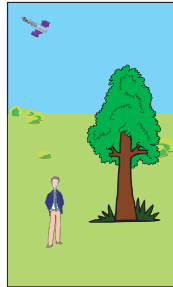

Downtown

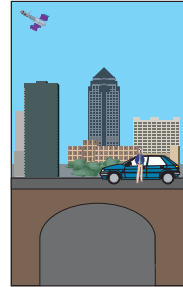

Not Recommended for Best Reception

Beach



Office



Park

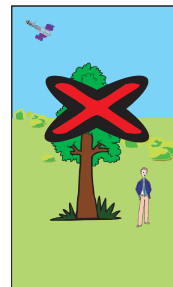

Downtown

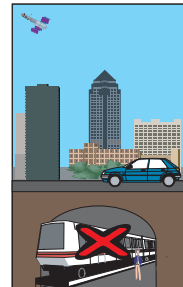

FM Transmitter feature is found on the Stream | jockey receiver.

To access the FM Transmitter Feature:

Press the **MENU** button *on the Stream | jockey receiver's* key pad. Press the \wedge **CH** or \vee **CH** button to scroll to the FM Transmitter selection and press **SELECT** button.

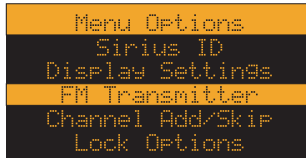

The following adjustments can be made:

- Frequency
- FM On/Off

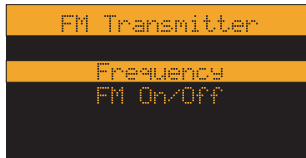

Frequency: enables you to select any one of the pre-programmed FM channels. Press the \wedge **CH** or \vee **CH** button to select a desired channel, then press the **SELECT** button to confirm the setting. To exit this function, press **MENU** or **SELECT** button.

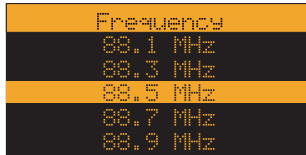

FM On/Off: To activate/deactivate the FM transmitter.



SPECIFICATIONS

Stream | jockey Power Pod™

Charger

DC Input	9V DC
Max DC Input:	DC13.20v +/-1.80V
DC Adapter Current Output:	1.32A +0.03 / - 0.00A
Charging Current:	1.50A +/-0.15A (in standby mode)
Charging Time*:	5~6 Hours (When receiver is not in use.)
(Fully Discharged Battery)	9~10 Hours (When receiver is in use.)

*Battery operation and charging time may vary depending on the condition and environment which the equipment is used under.

Charging Indicator:	Dual Color LED (Red = Charging, Green = Fully Charged)
Operating Temperature:	0°C~45°C

Problem Solving Section

For your assistance, we have listed a few common problems below.

The System does not work

Check that the Receiver is correctly in place. Check the Power Cable or Battery. Make sure you have disconnected the DC Power Adapter if you wish to use the battery. Make sure you have contacted SIRIUS® to activate your Satellite Radio subscription 1-888-539-SIRIUS (7474).

When using the battery the system works intermittently

Check the battery pack is securely in place and recharge if necessary.

The Battery does not charge

Check the Power Cable or Battery. Make sure you have disconnected the DC Power Adapter from the wall jack and unit. Make sure that you remove the Receiver.

The LCD displays Acquiring Signal

When the audio signal is lost, a pop-up window with the message “Acquiring Signal” is displayed until the signal is recovered.

The LCD Displays a pop-up window with the message “Acquiring Signal” or “Antenna not Detected”.

When antenna signal is lost, check antenna signal and strength, reposition the antenna for maximum signal strength. Change the location of the Antenna making sure it is away from obstructions.

Reception is weak or the audio has static and is unclear.

Change the location of the Antenna making sure it is away from obstructions.

There is no sound from the external speakers or Stereo System.

Make sure that the FM Transmitter Setting is set to the correct channel as your FM Radio.

WARRANTY

Warranty Information

Xact Communication

One-Year Limited Warranty

This limited warranty sets forth all **Xact Communication** responsibilities regarding your product. There are no other expressed or implied warranties from **Xact Communication**.

Warranty Service Provided

If you purchased the product new from a retail vendor, **Xact Communication** warrants the equipment against defects in material and workmanship for a period of one (1) year from the original date of purchase. This warranty is in lieu of all other express warranties. This warranty begins when you purchase the product and continues for one (1) year unless you sell or rent the unit, in which case the warranty stops.

Xact Communication disclaims any implied warranty, including the warranty of merchantability and the warranty of fitness for a particular purpose, as of the date of one year from your original purchase of the product. **Xact Communication** assumes no responsibility for any special, incidental, or consequential damages.

This warranty gives you specific legal rights and you may have other rights which vary from state to state. Some states do not allow the exclusion or limitations of special, incidental, or consequential damages or limitations on how long a warranty lasts, so the above exclusion or limitation may not apply to you.

Warranty Service Not Provided

This warranty does not cover damage resulting from accident, misuse, abuse, improper installation or operation, lack of reasonable care, unauthorized modification, or the affixing of any attachment not provided by **Xact Communication** with the equipment, and/or loss of parts. This warranty is voided in the event any unauthorized person opens, alters, or repairs the product.

All **Xact Communication** equipment being returned for repair must be suitably packaged.

WARRANTY

What To Do for Warranty Service

During the first thirty (30) days, a defective product is eligible for over-the-counter exchange at the retailer from whom it was purchased. After thirty (30) days, the defective product should be returned to the authorized service center. Please allow a minimum of 2-3 weeks for the return of your product. For the shipping address of the authorized service center, call one of the telephone numbers given below.

Your product will be repaired or replaced if examination by the service center determines the product is defective. Products received damaged as a result of shipping will require you to file a claim with the carrier prior to repair. A product received with missing parts or with damage due to abuse, inadequate packing or some other noncompliance with this limited warranty will be returned to you C.O.D., freight collect.

NOTE: A product received which was not made by **Xact Communication** or which is not defective as determined by our test procedures will not be repaired and will be returned to you C.O.D., freight collect.

To Obtain Warranty Service

- Provide proof of the date of purchase within the package.
- Prepay all shipping costs to the authorized service center.
- Include a return shipping address within the package.

Please retain your sales receipt, the carton, the packing materials, and the printed material. The original carton is the best shipping container for the Product should you have to return it.

For your reference:

Model Number _____

ESN Number _____

S/N Number _____

Date of Purchase _____

Name of Dealer _____

***Xact Communication Customer Service Telephone Number:
1-866-466-XACT (9228)***

OUTSIDE THE U.S.A. AND CANADA CALL: 1-212-481-7950

Visit Us on the Web: www.getxact.com

To activate your Satellite Radio Receiver or for latest news and questions regarding SIRIUS® Satellite Radio service visit sirius.com or call 1-888-539-SIRIUS (7474).



Call Toll Free 1-866-466-XACT (9228)
or Visit our Website:

www.getxact.com