

**FEATURES**

- Create perfectly brewed coffee, espresso, cappuccino, macchiato and latte at home.
- 30" trim kits available to match Wolf M and E series ovens.
- Standard or flush inset installation.
- Separate hot water dispenser for tea.
- Mounted glide system provides easy access to the unit, no direct water line is needed.
- Milk frothing pitcher with adjustable settings detaches for refrigerated storage and easy cleaning—milk does not enter the system.
- Uses either whole-bean or ground coffee with adjustable brew strength.
- Built-in coffee mill with adjustable grind settings.
- Auto on, auto off and descaling features.
- Install with a Wolf cup warming drawer to preheat cups, so hot beverages stay hot longer.

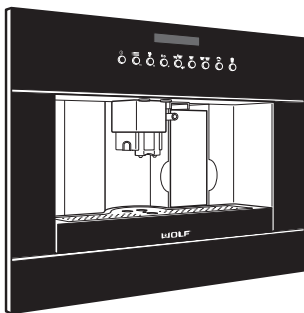

Model EC24/B

MODEL	
Black	EC24/B

**ACCESSORIES**

- 30" trim kits to match Wolf M and E series ovens (see below).
- Descaling solution.
- Care kit.

Accessories available through an authorized Wolf dealer. For local dealer information, visit the find a showroom section of our website, wolfappliance.com.

**TRANSITIONAL**



With M series trim.

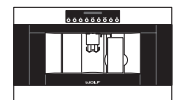

With E series trim.

**PROFESSIONAL**

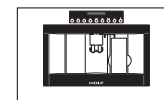

With M series trim.

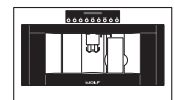

With E series trim.

**CONTEMPORARY**

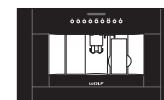

With M / E series trim.

**SPECIFICATIONS**

**PRODUCT**

Dimensions 23<sup>1</sup>/<sub>2</sub>"W x 17<sup>7</sup>/<sub>8</sub>"H x 15<sup>1</sup>/<sub>2</sub>"D  
 30" Trim 29<sup>7</sup>/<sub>8</sub>"W  
 Weight 80 lb

**ELECTRICAL**

Supply 120 VAC, 60 Hz  
 Service 15 amp circuit  
 Power Cord 6'

**DIMENSIONS**

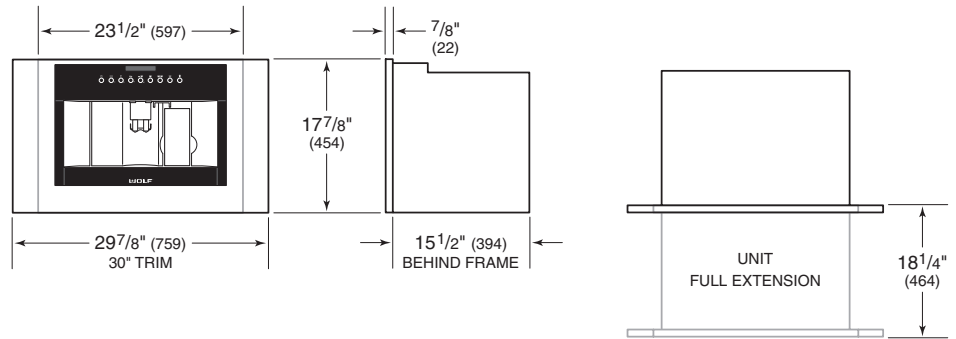

Specifications are subject to change without notice. Visit [wolfappliance.com/specs](http://wolfappliance.com/specs) for the most up-to-date information.

Dimensions may vary ±1/8" (3). Dimensions in parentheses are millimeters unless otherwise specified.

**STANDARD INSTALLATION**



NOTE: 24" (610) model and model with 30" (762) trim require the same opening dimensions.

**FLUSH INSET INSTALLATION**

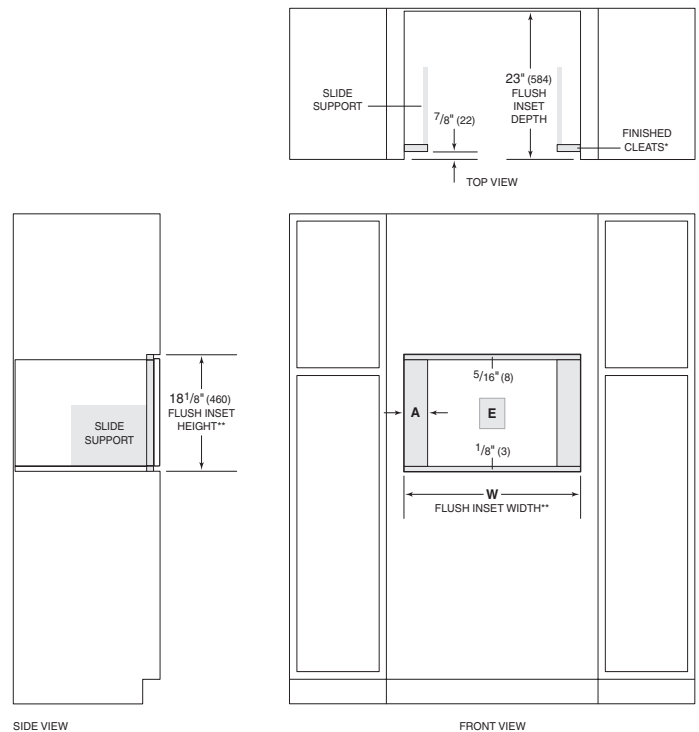

\*Will be visible and should be finished to match cabinetry.  
 \*\*Dimension provides minimum reveals.

FLUSH INSET WIDTH			
COFFEE	W	A	
24" Model	23 <sup>3</sup> / <sub>4</sub> " (603)	1 <sup>3</sup> / <sub>16</sub> " (21)	
30" Trim	30 <sup>1</sup> / <sub>8</sub> " (765)	4" (102)	