

**marantz®**

AV Surround Receiver  
**SR7009**

Quick Start Guide

Guide de démarrage rapide

Guía de inicio rápido

ENGLISH

FRANÇAIS

ESPAÑOL

# Welcome

Thank you for choosing a Marantz AV receiver. This guide provides step-by-step instructions for setting up your AV receiver.

**Please do not return this unit to the store – call for assistance.**

**If you need help... :**

If you need additional help in solving problems, contact Marantz customer service in your area.

## 1-855-ONE-Marantz

1-855-663-6272

Call for Assistance:

Monday – Friday 10:00AM to 10:00PM E.S.T.

Saturday 12:00PM to 8:00PM E.S.T

For frequently asked questions please visit

<http://marantz.custhelp.com/app/answers/list>

For US and Canada only

# Before You Begin

## Required for Setup

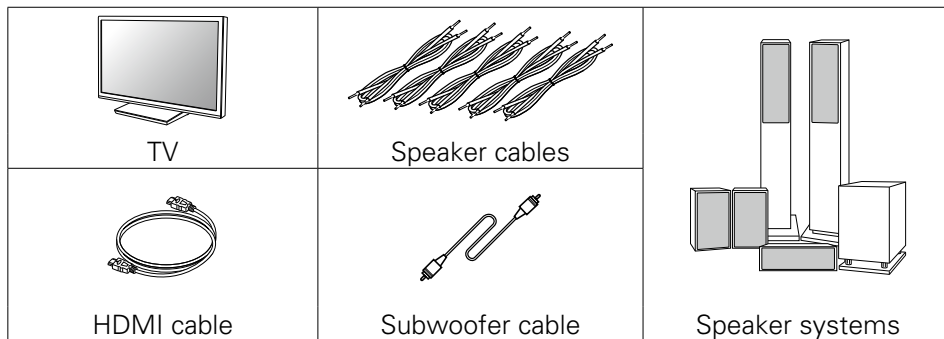



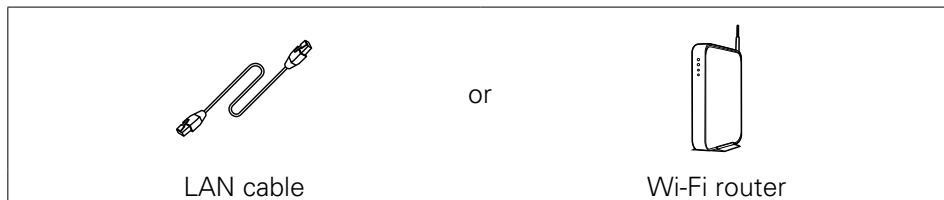











## Optional

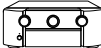

- When connecting this unit to a device that is compatible with the Deep Color, 4K and ARC functions, use a “High Speed HDMI cable with Ethernet” that displays the HDMI logo.
- These drawings are for illustrative purposes only and may not represent the actual product(s).

# What's In the Box

|                               |   |   |   |
|-------------------------------|---|---|---|
| Quick Start Guide             |  | FM indoor antenna                                     |  |
| Owner's Manual                |  | AM loop antenna                                       |  |
| Safety Instructions           |  | Sound calibration microphone                          |  |
| Notes on radio                |  | Sound calibration microphone stand                    |  |
| Warranty (for USA/for CANADA) |  | Remote control unit                                   |  |
| Cable labels                  |  | R03/AAA batteries                                     |  |
| Receiver                      |  | External antennas for Bluetooth/Wireless connectivity |  |
| Power cord                    |  |   |   |



The supplied Sound calibration microphone stand is convenient for use when performing Speaker Calibration. Using your own tripod or the supplied Sound calibration microphone stand enables settings to be automatically configured to the optimum listening environment, providing exceptionally high performance.

# Important: External Antennas

The removable external antennas are required for both Bluetooth and Wireless network connectivity. Please make sure to connect the antennas before attempting to use the Bluetooth or Wi-Fi features of the SR7009.

## ❑ Connecting the external antennas for Bluetooth/Wireless connectivity

For each of the two antennas:

- 1) Place the antenna evenly over the antenna terminal located at the upper left or right corner of the rear panel.
- 2) Turn the antenna clockwise until it is fully connected. Do not over tighten.
- 3) Rotate the antenna upwards for the best possible reception.

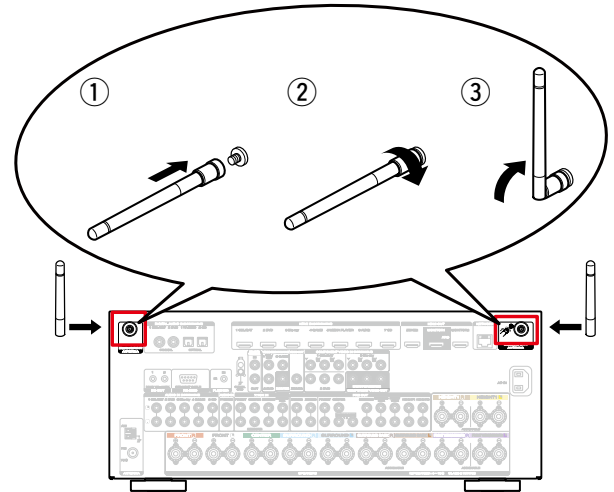

# Setup

There are three steps to the setup process.

**1** Installing batteries in the remote control unit

**2** Connecting the receiver

**3** Following the On-Screen Setup Assistant

**1**

## Installing batteries in the remote control unit

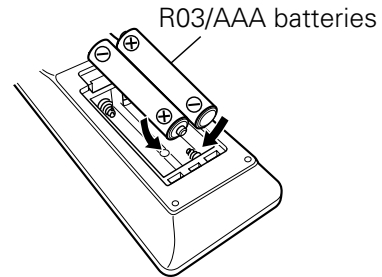
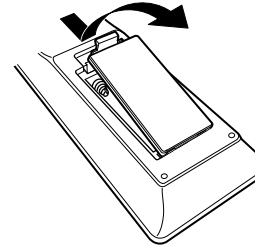

## 2 Connecting the receiver

2.1) Place the receiver near your TV and connect the power cord.

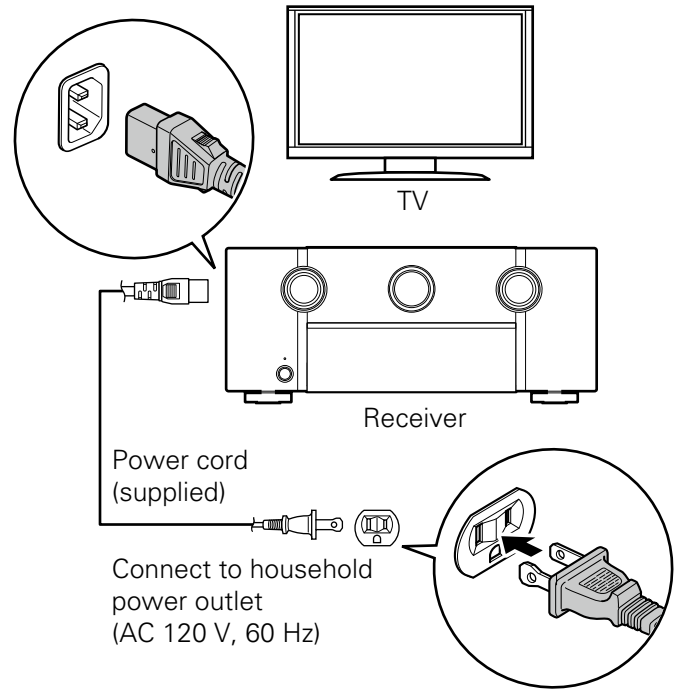

## 2.2) Connect to the network.

### Wired LAN

When connecting cables (wired connection), connect a LAN cable between your receiver and your network router.

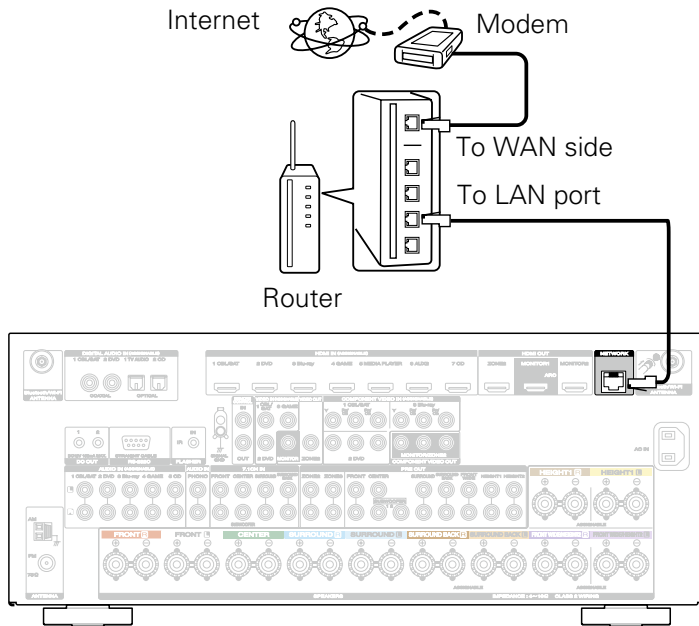

### Wireless LAN

When connecting to wireless LAN (Wi-Fi), follow the instructions in "Connecting the external antennas for Bluetooth/Wireless connectivity" and connect the antennas.

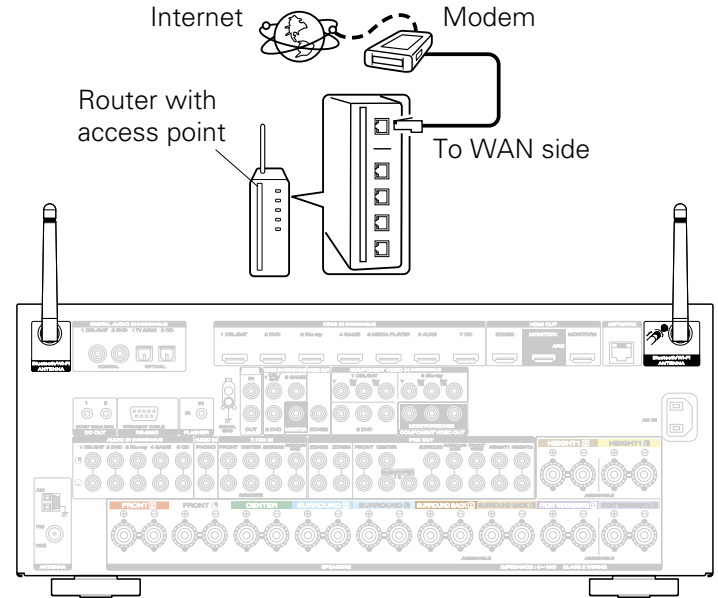

### 2.3) Connect the receiver to your TV with an HDMI cable.

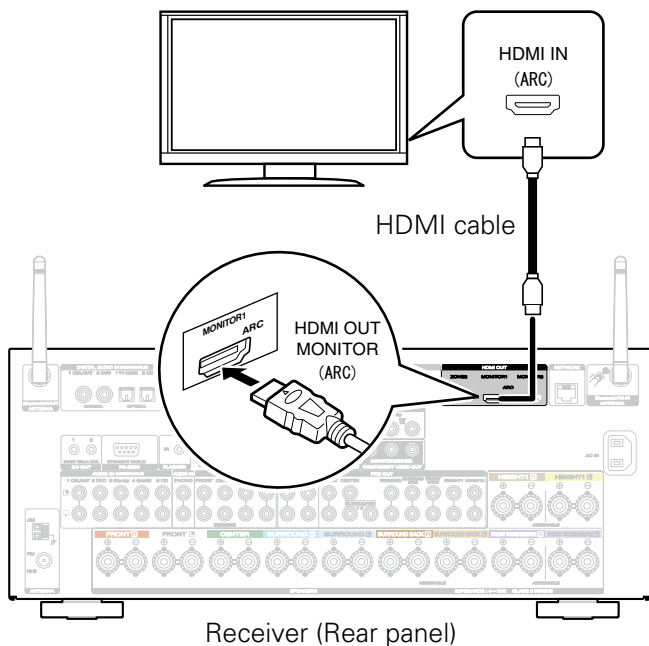

### 2.4) Turn on the TV.

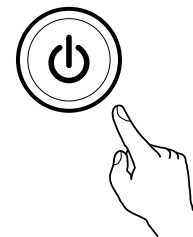
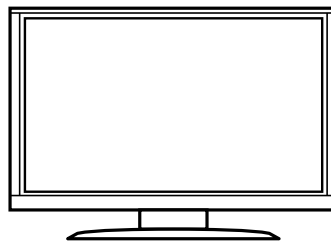

TV remote control unit

### 2.5) Select the appropriate HDMI input on your TV.

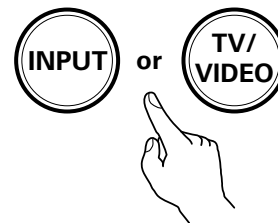
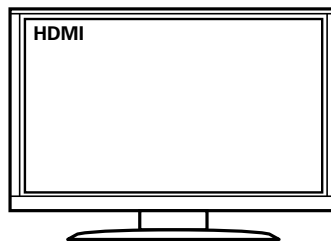

TV remote control unit

## 2.6) Turn on the receiver.

- Press  to turn on the receiver.

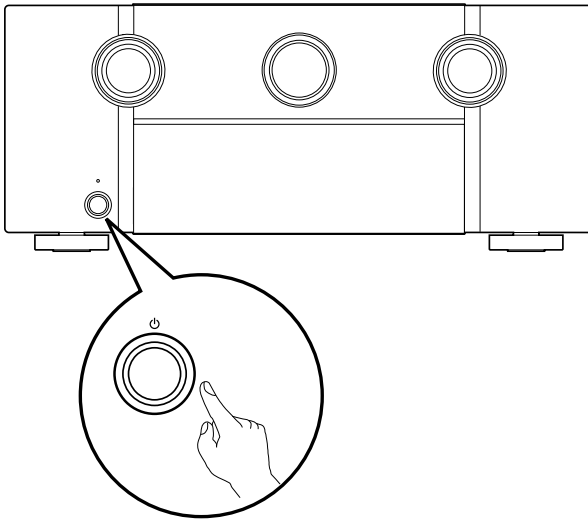

## 2.7) Verify the connection.

- Verify that you can see this screen on your TV.



If this screen is not displayed, please go back and retry the steps again in the recommended sequence.

### 3 Following the On-Screen Setup Assistant

The Setup Assistant will walk you through connecting and configuring your speakers and components to your Marantz receiver. Please use the remote control and follow the on-screen instructions.

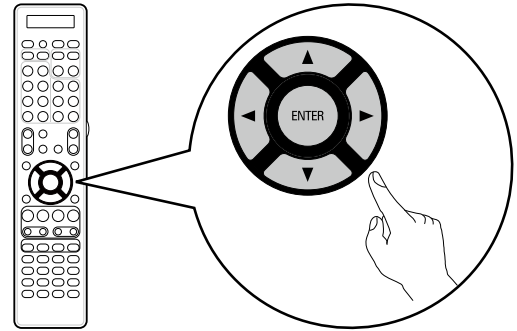

# Owner's Manual

Please reference to the Owner's Manual for more details about the setup and operation of the receiver and its features.

## ❑ Online Version

Enter the following URL into your web browser:  
[manuals.marantz.com/SR7009/NA/EN/](http://manuals.marantz.com/SR7009/NA/EN/)



Online Manual

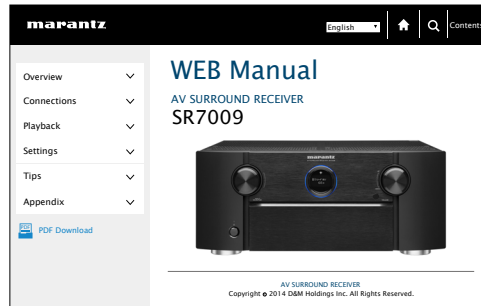

## ❑ Printable Version

Access the print version of the owner's manual from the included CD-ROM or select the "PDF Download" link from the Online Version.

1

**Insert the disc into your PC.**

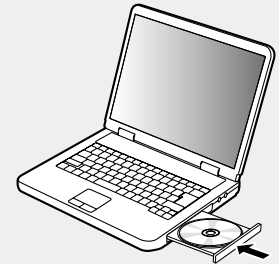

2

**Follow the screen or double click on the PDF file.**

**[www.marantz.com](http://www.marantz.com)**

You can find your nearest authorized distributor or dealer on our website.

**marantz**<sup>®</sup> is a registered trademark.