

30" Downdraft

Downdraft Ventilation - Stainless Steel DHD3014UC



DHD3014UC
Stainless Steel

The perfect solution for high ceilings, islands, or simply for space considerations, our downdraft rises from behind your cooktop.

Features & Benefits

Allows you to adjust the performance of your hood to match the type of cooking.

The filter is concealed behind a stylish stainless steel cover to hide grease build up.

Flexible design gives the ability to recirculate the air back into the kitchen.

With the touch of the controls, chimney will automatically rise to over 13", and after use chimney lowers flush with the cooking surface.

600 CFM blowers available for remote, inline, and internal applications.

General Properties

Operating mode	Convertible: ducted / recirculating
Maximum CFM	Blower Sold Separately
Number of speed settings	3-stage
Motor location	External
Damper included	Yes
Grease filter material	Washable stainless steel
Grease filter type	Multilayer cassette

Technical Details

Volts (V)	120 V
Frequency (Hz)	60 Hz
Plug type	120V-3 prong
Power cord length (in.)	30"



Dimensions & Weight

Overall appliance dimensions (width of canopy included) (HxWxD) (in.)	21 5/8" x 31" x 3 3/4"
Height of the rise (in.)	13"
Diameter of air duct (in.) top	10"
Net weight (lbs)	37 lbs

Accessories—Optional



DHZDHR6
6" duct transition

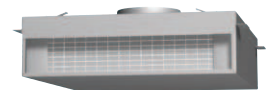

DHDRM36UC
Recirculation kit

NOTE: Required with the installation of inline and remote blowers for downdraft applications only. DHZDHR6 is for 600 CFM which will improve overall performance.

For help and assistance with Bosch accessories please visit: www.bosch-eshop.com/eshop/bosch/us or call 1-800-944-2904 Mon-Fri 5am to 6pm PST Sat 6am to 3pm PST

Notes: All height, width and depth dimensions are shown in inches. Please refer to installation instructions prior to making cutout. BSH reserves the absolute and unrestricted right to change product materials and specifications, at any time, without notice. Consult the product's installation instructions for final dimensional data and other details. Applicable product warranty can be found in accompanying product literature or you may contact your account manager for further details.

Warranties: Bosch warrants that the Product is free from defects in materials and workmanship for a period of three hundred and sixty-five (365) days from the date of purchase. The foregoing timeline begins to run upon the date of purchase, and shall not be stalled, tolled, extended, or suspended, for any reason whatsoever. This Product is also warranted to be free from cosmetic defects in material and workmanship (such as scratches of stainless steel, paint/porcelain blemishes, chip, dents, or other damage to the finish of the Product, for a period of thirty (30) days from the date of purchase or closing date for new construction. This cosmetic warranty excludes slight color variations due to inherent differences in painted and porcelain parts, as well as differences caused by kitchen lighting, product location, or other similar factors. This cosmetic warranty specifically excludes any display, floor, "As Is", or "B" stock appliances.

For more information on our entire line of products, go to www.bosch-home.com/us or call 1-800-944-2904

© BSH Home Appliances Corporation. All rights reserved. Bosch is a registered trademark of Robert Bosch GmbH.

30" Downdraft

Downdraft Ventilation - Stainless Steel DHD3014UC



Installation Details

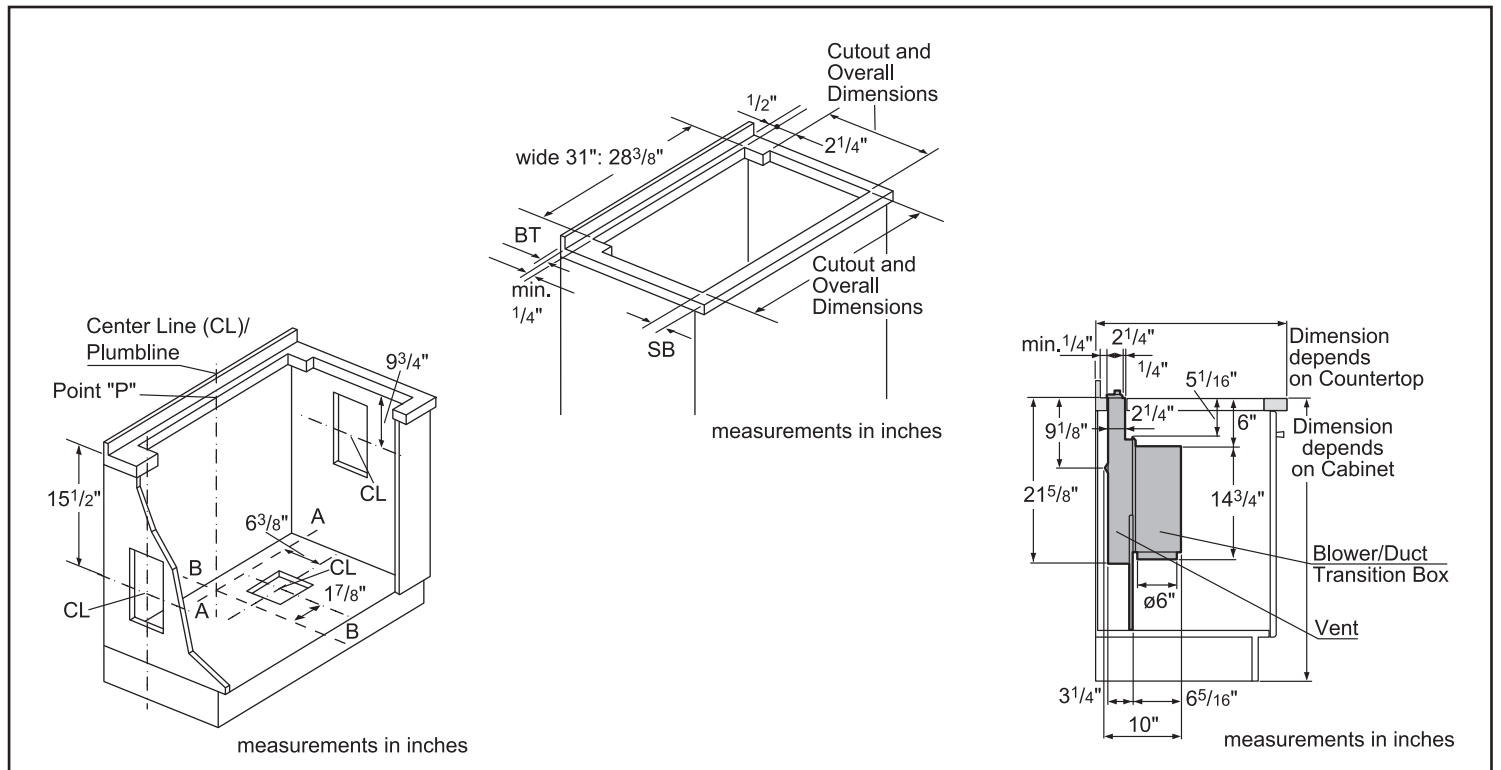
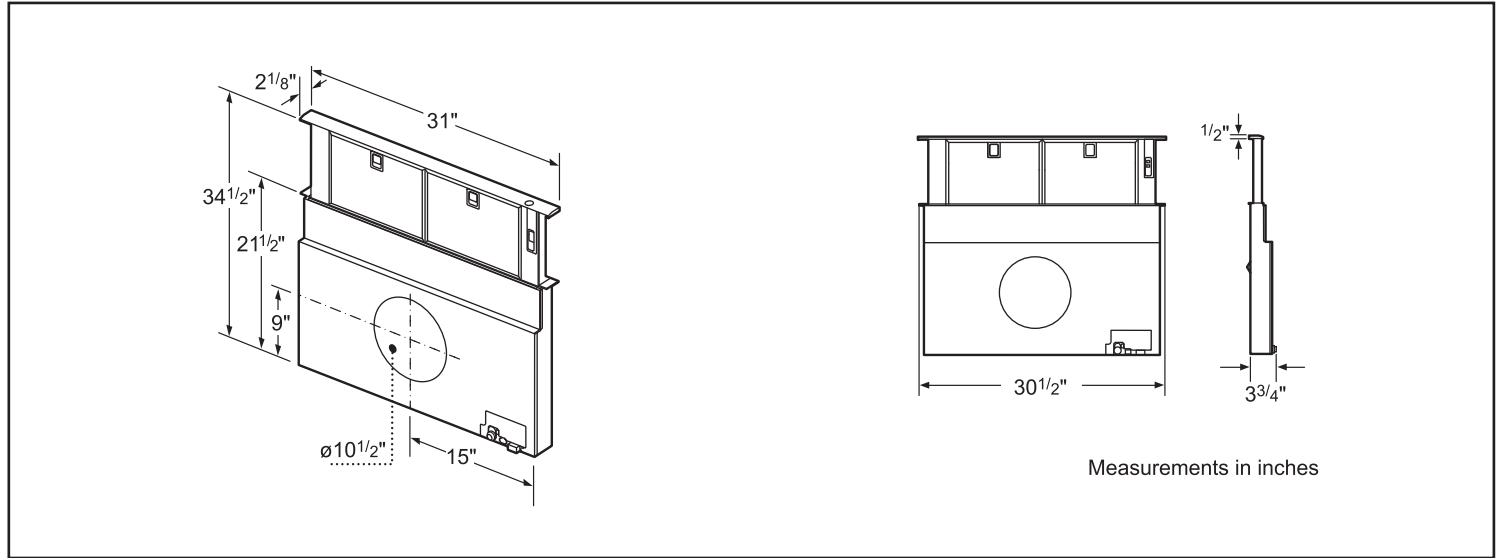

For help and assistance with Bosch accessories please visit: www.bosch-eshop.com/eshop/bosch/us or call 1-800-944-2904 Mon-Fri 5am to 6pm PST Sat 6am to 3pm PST

Notes: All height, width and depth dimensions are shown in inches. Please refer to installation instructions prior to making cutout. BSH reserves the absolute and unrestricted right to change product materials and specifications, at any time, without notice. Consult the product's installation instructions for final dimensional data and other details. Applicable product warranty can be found in accompanying product literature or you may contact your account manager for further details.

Warranties: Bosch warrants that the Product is free from defects in materials and workmanship for a period of three hundred and sixty-five (365) days from the date of purchase. The foregoing timeline begins to run upon the date of purchase, and shall not be stalled, tolled, extended, or suspended, for any reason whatsoever. This Product is also warranted to be free from cosmetic defects in material and workmanship (such as scratches of stainless steel, paint/porcelain blemishes, chip, dents, or other damage to the finish of the Product, for a period of thirty (30) days from the date of purchase or closing date for new construction. This cosmetic warranty excludes slight color variations due to inherent differences in painted and porcelain parts, as well as differences caused by kitchen lighting, product location, or other similar factors. This cosmetic warranty specifically excludes any display, floor, "As Is", or "B" stock appliances.

For more information on our entire line of products, go to www.bosch-home.com/us or call 1-800-944-2904

© BSH Home Appliances Corporation. All rights reserved. Bosch is a registered trademark of Robert Bosch GmbH.