

axxera™

CD Receiver

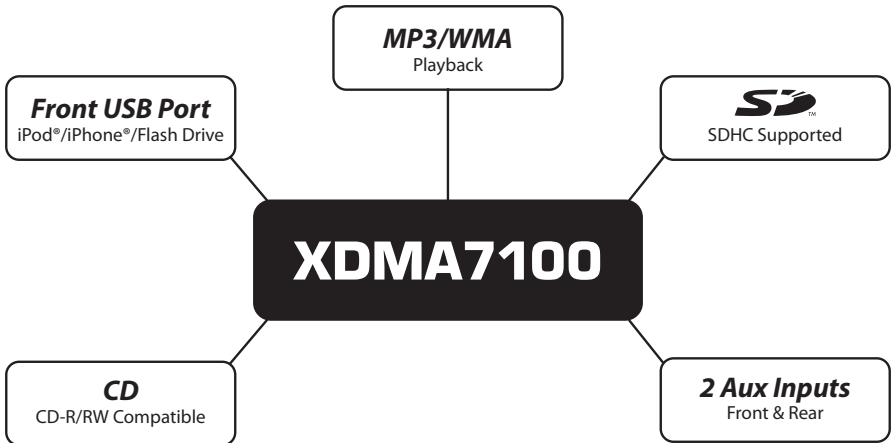

Installation & Owner's Manual



XDMA7100

Preparation

Please read entire manual before installation.

Before You Start

- Disconnect negative battery terminal. Consult a qualified technician for instructions.
- Avoid installing the unit where it would be subject to high temperatures, such as from direct sunlight, or where it would be subject to dust, dirt or excessive vibration.

Getting Started

- Remove trim ring from unit,
- Remove 2 transit screws located on top of the unit.
- Insert the supplied keys into the slots as shown, and slide the unit out of the mounting sleeve.
- Install mounting sleeve into opening, bending tabs to secure.
- Connect wiring harness and antenna. Consult a qualified technician if you are unsure.
- Certain vehicles may require an installation kit and/or wiring harness adapter (sold separately).
- Test for correct operation and slide into mounting sleeve to secure.
- Snap trim ring into place.

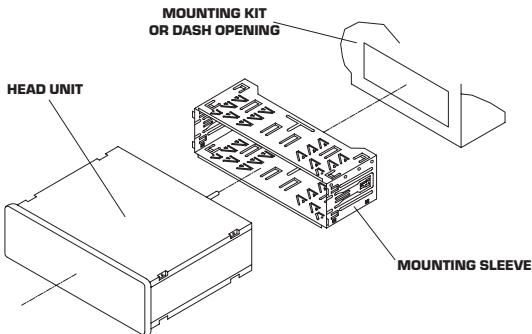
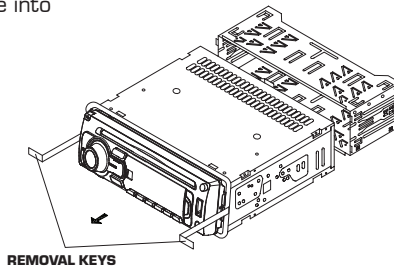

TYPICAL FRONT-LOAD DIN MOUNTING METHOD

XDMA7100

Wiring Diagram

RCA Preamp Output Connections

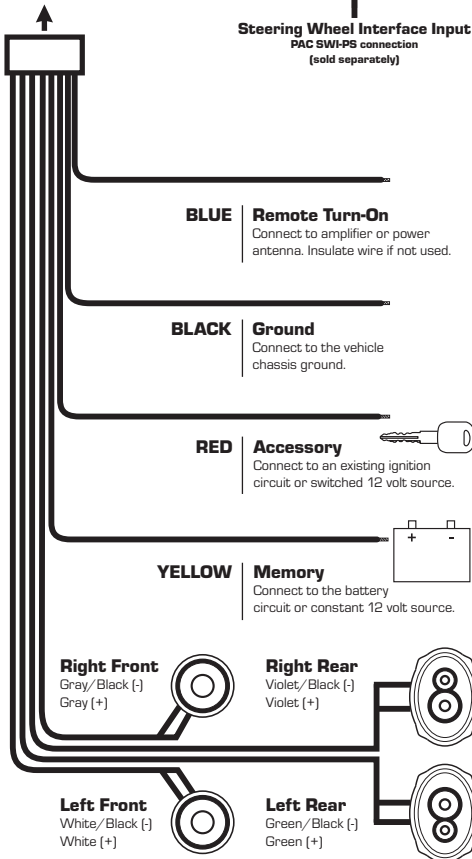
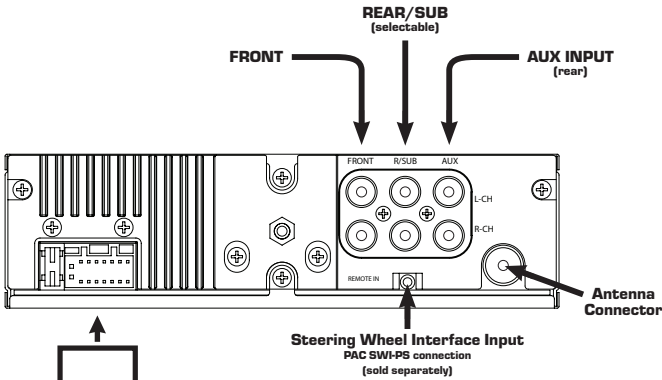

FUSE

When replacing the fuse, make sure new fuse is the correct type and amperage. Using an incorrect fuse could damage the radio. The XDMA7100 uses one 10 amp ATM fuse located beside the wiring connector.

XDMA7100

Control Locations - Receiver

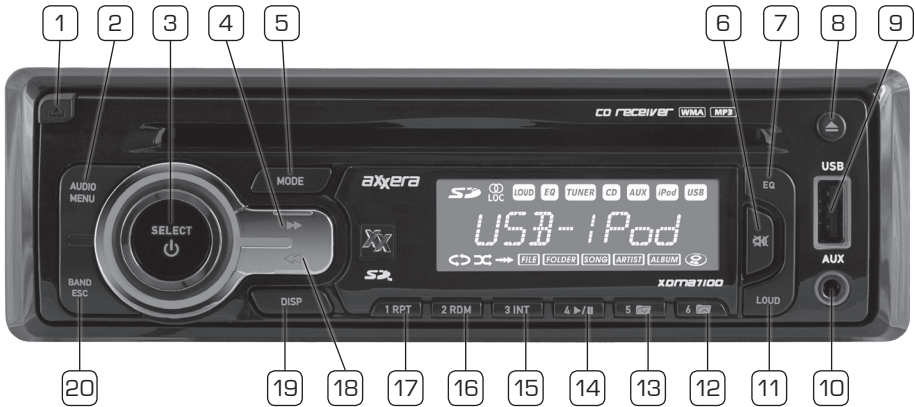

Control	Function	Description
1	Release	Opens and removes the front panel.
2	Audio/Menu	Accesses the audio options. Hold to access the setup menu.
3	Select/Power	Activates music searches. Confirms menu options. Hold to turn the power off.
4	Track/Tune Up	Changes to the next song or radio station. Hold to fast forward or seek up.
5	Mode	Changes to another mode of operation. Hold down to power off/on.
6	Mute	Silences the audio output.
7	EQ	Cycles through the preset equalizer curves.
8	Eject	Ejects the CD. Hold to force eject a stuck CD.
9	USB Port	Connect a USB flash drive, iPod or iPhone device.
10	Auxiliary Input	Connect a 3.5mm cable from the headphone output of an MP3 player.
11	Loud	Toggles the Loud sound mode on and off.
12	Preset 6/Folder Up	Recall/Set preset 6. Changes to the next folder.
13	Preset 5/Folder Down	Recall/Set preset 5. Changes to the previous folder.
14	Preset 4/Play/Pause	Recall/Set preset 4. Cycle between pause/play.
15	Preset 3/Intro	Recall/Set preset 3. Intro menu (plays the first 10 seconds of each song).
16	Preset 2/Random	Recall/Set preset 2. Random menu (shuffles songs in a random playback order).
17	Preset 1/Repeat	Recall/Set preset 1. Repeat menu (repeat the current song, folder or album).
18	Track/Tune Down	Changes to the previous song or radio station. Hold to rewind or seek down.
19	Display	Cycles displayed information. Hold to set the clock.
20	Band/Esc	Accesses more radio presets, cycles between FM/AM radio. Exits menus.

XDMA7100

Control Locations - Remote

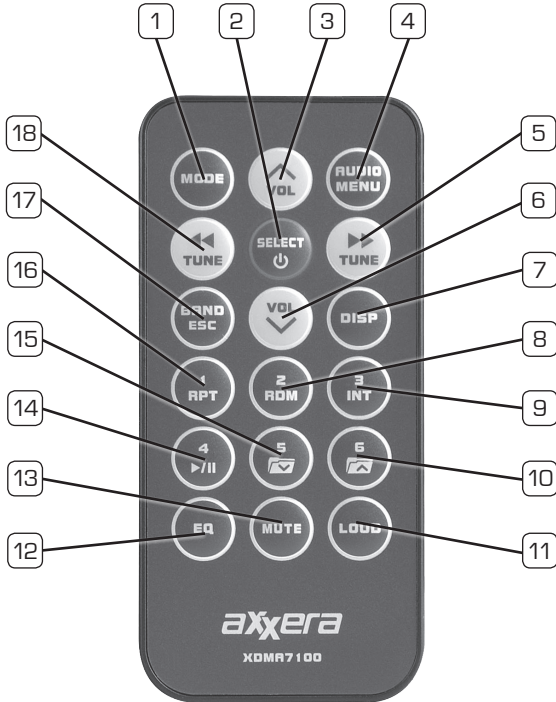

- | | | | |
|---|--------------------|----|-------------------------|
| 1 | Mode | 10 | Preset 6 / Folder Up |
| 2 | Select / Power (⏻) | 11 | Loud |
| 3 | Volume Up | 12 | Equalizer |
| 4 | Audio / Menu | 13 | Mute |
| 5 | Tune / Track Up | 14 | Preset 4 / Play / Pause |
| 6 | Volume Down | 15 | Preset 5 / Folder Down |
| 7 | Display | 16 | Preset 1 / Repeat |
| 8 | Preset 2 / Random | 17 | Band / Esc |
| 9 | Preset 3 / Intro | 18 | Tune / Track Down |

XDMA7100

General Operation

Power On/Off	Press ⏻ or any other button (except EJECT) to turn the unit on. Press and hold ⏻ for 3 seconds to turn the unit off.
Mode	Press MODE to select between AM/FM, CD player, auxiliary front/rear, operation of iPod, USB and SD card. Modes of operation are shown in the display. NOTE: CD, USB and operation of iPod modes will not appear unless a CD is inserted or USB/iPod devices are connected.
Auxiliary Inputs	The XDMA7100 offers two auxiliary input ports, a 3.5 mm port on the front panel and an RCA connection on the back of the unit. Use either connection to connect audio device, MP3 player, etc. Press MODE to select AUX FRONT or AUX REAR modes.
Steering Wheel Interface Input	The steering wheel interface input located on the back of the head unit allows connection to the Pacific Accessory Corporation (PAC) SWI-PS interface module (sold separately). Visit www.pac-audio.com for details. To configure steering wheel controls, follow the instructions provided with the PAC SWI-PS interface module. After installing the interface module, insert the module's 3.5mm jack into the port on the back of the head unit.
Volume	Adjust volume using volume knob (00-46).
Display	Press DISP to select between clock and different types of information, such as radio frequency, CD track/elapsed time or MP3/WMA song information.
Reset	Press RESET upon initial installation or if abnormal operation occurs. Reset button is located behind the front panel.
Set the Clock	With the unit on, press and hold DISP until the clock begins to flash, then release. Press TUNE ◀◀ to adjust the hours and TUNE ▶▶ to adjust the minutes. Press DISP momentarily to save the selected time.
12/24-hour Clock	The clock will display 12-hour AM/PM time in USA frequency spacing mode (PM 10:00). In European frequency spacing mode, the clock will display 24-hour time (22:00).
Setup Menu	Press and hold AUDIO/MENU for more than 3 seconds to access the setup menu. Press AUDIO/MENU momentarily to select between the menu functions and rotate the volume knob left/right to adjust or activate the desired function.

XDMA7100

General Operation - Setup Menu

Menu Function	Options	Action
Auto Station Store	AUTO STORE	Press SELECT to seek and save 6 strong stations in the current band. (Tuner mode only)
Local/Distance Tuning	LOCAL OFF	Activates distance tuning (Tuner mode only) .
	LOCAL ON	Activates local tuning for strong station reception only (Tuner mode only) .
Tuner Frequency Spacing	FREQ USA	Programs the unit to USA tuner spacing. (200kHz for FM and 10kHz for AM). (Tuner mode only)
	FREQ EUR	Programs the unit to European tuner spacing. (50kHz for FM and 9kHz for AM). (Tuner mode only)
Selectable iPod Control	IPOD FULL	Programs the head unit to advanced control of the iPod/iPhone device. (Operation of iPod mode only)
	IPOD BASIC	Programs the head unit to basic control of the iPod/iPhone device and allows music to be controlled from the iPod/iPhone device. (Operation of iPod mode only)
Clock Display	CLOCK OFF	Programs unit to not display the clock when the power is off.
	CLOCK ON	Programs unit to display the clock when the power is off.
Front Auxiliary Input	AUX FR ON	Enables the front panel 3.5mm auxiliary input.
	AUX FR OFF	Disables the front panel 3.5mm auxiliary input.
Rear Auxiliary Input	AUX RE ON	Enables the rear RCA auxiliary input.
	AUX RE OFF	Disables the rear RCA auxiliary input.
Rear/Sub RCA output	R/S SUB	Programs the Rear/Sub RCA preamp output to subwoofer.
	R/S REAR	Programs the Rear/Sub RCA preamp output to rear.
Beep Confirmation	BEEP OFF	Disables the confirmation beep.
	BEEP ON	Enables the confirmation beep.
Programmable Turn On Volume	PRO-VOL #	Programs unit to always turn on at a specific volume (default is OFF). Any volume level 1-46 can be selected.
Power on Message	MSG OFF	Disables power on message. (example: GOOD MORNING)
	MSG ON	Enables power on message to be displayed.
Scrolling Option	SCROLL 15 S	Programs unit to scroll information once every 15 seconds (default).
	SCROLL ONCE	Programs unit to scroll once, then show the first 10 characters on display.
	SCROLL ON	Programs unit to scroll continuously.
	SCROLL OFF	Programs unit to show the first 10 characters on the display.
Illumination Dimmer	DIMMER HI	Programs unit to the brightest illumination level.
	DIMMER MED	Programs unit to the middle illumination level.
	DIMMER LOW	Programs unit to the dimmest illumination level.
Demonstration Mode	DEMO OFF	Disables the demonstration mode.
	DEMO ON	Enables the demonstration message.

XDMA7100

General Operation

Audio Press **AUDIO** momentarily to select between Bass, Treble, Balance, Fader, Subwoofer and Source Volume Level.

➔ **BASS** ➔ **TREBLE** ➔ **BALANCE** ➔ **FADER** ➔ **SUBWOOFER*** ➔ **SOURCE LEVEL** ➔

Bass Press **AUDIO** until **BASS** appears then rotate volume knob left/right to adjust [-6 minimum / +6 maximum].

Treble Press **AUDIO** until **TREBLE** appears then rotate volume knob left/right to adjust [-6 minimum / +6 maximum].

Balance Press **AUDIO** until **BAL** appears then rotate volume knob left/right to adjust (BAL LEFT 12 - BAL RIGHT 12).
• BAL EVEN represents equal balance

Fader Press **AUDIO** until **FADER** appears then rotate volume knob left/right to adjust (FADER FRONT 12 - FADER REAR 12).
• FAD EVEN represents equal fader

*** Subwoofer** Press **AUDIO** until **SUB** appears then rotate volume knob left/right to adjust (0 minimum / +12 maximum).

*** Note:** Subwoofer option will not appear if the REAR/SUB option in the setup menu is set to REAR. Refer to page 7 for details.

EQ Press **EQ** to cycle through the following equalization curves: FLAT (default), POP, JAZZ, CLASSIC, BEAT, ROCK and USER. Any manual adjustment to the Bass or Treble settings are automatically saved as USER.

Source Volume Level The source volume level control allows a gain adjustment for each audio source: AM, FM, CD, AUX FRONT/REAR, operation of iPod, USB and SD card. Set the source volume level for each mode, depending on the relative volume of each audio source.

To set the source volume level, press **AUDIO** until SRC LEVEL appears. After one second, the current mode will appear on the display. Turn the volume knob to adjust the audio level of the current source (-6 minimum/ +6 maximum).

Note: Only the current mode will be available for adjustment. To adjust another mode of operation, press **MODE** until the desired mode is selected, then set the source volume level for that mode.

XDMA7100

AM/FM Tuner Operation

Seek Tuning	Press TUNE ◀◀ or TUNE ▶▶ for more than one second to seek to the next strong station.
Manual Tuning	Press TUNE ◀◀ or TUNE ▶▶ momentarily to change radio frequency up or down one step at a time. Press and hold to advance quickly.
Band	Press BAND to select between FM1, FM2, FM3, AM1 and AM2 bands.
Storing and Recalling Station Presets	Up to 18 FM stations and 12 AM stations can be stored. To store a station, select the desired band and station. Press and hold the desired preset button (1-6) for more than 2 seconds. When stored, the preset number will appear in the display. The station can be recalled anytime by pressing the corresponding preset button.

CD Player Operation

Insert CD	With the label facing up, insert a standard size CD into the CD slot. The CD will automatically begin playback.
Eject CD	Press EJECT to eject the CD. The unit will change to previous mode of operation. If the disc is not removed within 10 seconds, the unit will reload the disc. The unit does not have to be turned on to eject CD.
Track Select	Press TRACK ►► to skip to the beginning of the next track. Press TRACK ◄◄ to return to the beginning of the current track. Pressing TRACK ◄◄ again skips to the beginning of the previous track.
Fast Forward and Reverse	Press and hold TRACK ►► or TRACK ◄◄ to fast forward or reverse a track.
Pause	Press ►/ to temporarily stop CD playback. Press ►/ again to resume playback.
Intro	Press INT to enter the Intro menu, then turn the volume knob to select one of the following options: <ul style="list-style-type: none">• OFF - Cancels the INT function.• ALL - Plays the first 10 seconds of each track.
Repeat	Press RPT to enter the Repeat menu, then turn the volume knob to select one of the following options: <ul style="list-style-type: none">• OFF - Plays all tracks on CD.• TRACK - Continuously repeats selected track.
Random	Press RDM to enter the Random menu, then turn the volume knob to select one of the following options: <ul style="list-style-type: none">• OFF - Cancels the RDM function.• ALL- Plays all tracks in random order.
CD-R/CD-RW Compatibility	<p>Some CD-Rs and CD-RWs may be incompatible with this unit, depending on media type and recording method. In addition, the following CDs may be incompatible with this unit:</p> <p>CDs exposed to extreme temperatures or direct sunlight for extended periods of time, CDs recorded in which a recording session failed or a re-recording was attempted and, or encrypted or copy-protected CDs which do not conform to the audio CD-DA red book recording standard.</p>

XDMA7100

CD Player Operation - MP3/WMA Files

Playing an MP3/WMA

Disc

When an MP3/WMA encoded disc is first inserted, "READING" will appear in the display. Depending on the number of files and folders, this may take several seconds.

Displaying Information

Press **DISP** to select between song title, artist, file name, folder name, track number, and clock/elapsed time.

"NO ID3 TAG" will be displayed if the MP3 file contains no ID3 tag information.

"UNKNOWN" will be displayed if the WMA file contains no WMA tag information.

"ROOT" will be displayed if the directory name of a root folder is not labeled.

Title Icon

This icon will illuminate when the song title is displayed.

Artist Icon

This icon will illuminate when the artist name is displayed.

Folder Icon

This icon will illuminate when the folder name is displayed.

File Icon

This icon will illuminate when the file name is displayed.

Character Support

Maximum character display information

- Track name – 32 character maximum
- Directory name – 32 character maximum
- *Song title – 30 character maximum
- *Artist name – 30 character maximum

*Song title and Artist Name will only be displayed if included with the MP3/WMA file.

When referring to MP3/WMA playback, the following terms are synonymous:

- File name and track name
- Folder name and directory name

XDMA7100

CD Player Operation - MP3/WMA Files

Folder/File Search Mode

MP3/WMA CD mode features a file and folder search mode. This search allows navigating through folders to find a specific MP3 or WMA file for playback.

Step 1 Press **SELECT**. "MP3 SEARCH" will appear, then a list of the files in the currently selected directory will be accessible.

Step 2 Turn the volume knob. The list of subfolders and files in the current folder will cycle. Turning the volume knob left will cycle to the beginning of the folder/file list. Any subfolders will be listed at the beginning of the list, followed by any files.

FOLDER will illuminate when a folder is highlighted.

FILE will illuminate when a file is highlighted.

Step 3 Navigate to the desired folder and file.

- To go up one folder level, press ESC once.
- To view the contents of a highlighted folder, press SELECT.

Note: the "FOLDERUP" option may also be selected to navigate up one folder level.

Step 4 Press **SELECT** to begin playing the selected MP3/WMA file.

Note: Press **ESC** from the root directory to exit search mode.

XDMA7100

CD Player Operation - MP3/WMA Files

Folder Access

Press  to select the previous folder.

Press  to select the next folder.

*Folder access is only available on MP3/WMA discs recorded with more than one folder.

Repeat

Press **RPT** to enter the Repeat menu, then turn the **volume knob** to select one of the following options:

- OFF - Plays all tracks on CD.
- TRACK - Continuously repeats selected track.
- FOLDER - Continuously repeats all files in selected folder.

Random

Press **RDM** to enter the Random menu, then turn the **volume knob** to select one of the following options:

- OFF - Cancels the **RDM** function.
- ALL - Plays all tracks in random order.
- FOLDER - Plays all tracks in folder in random order.

Note: Random mode is retained in memory when selecting between other modes and when the unit is turned on/off.

Intro

Press **INT** to enter the Intro menu, then turn the **volume knob** to select one of the following options:

- OFF - Cancels the **INT** function.
- ALL - Plays first 10 seconds of each track.
- FOLDER - Plays first 10 seconds of each track in folder.

Note: Folder repeat, random and intro options only function on MP3/WMA discs recorded with more than one folder.

XDMA7100

CD Player Operation - MP3/WMA Files

File/Folder Compatibility and Support

Compatible File Types	<ul style="list-style-type: none">• CD-ROM (ISO), CD-R, CD-RW• CD-DA (digital audio)• MP3 data (.mp3)• WMA data (.wma)
Incompatible File Types	<ul style="list-style-type: none">• DRM protected files• WMA lossless• Apple lossless• WMA Pro• MP3 Pro• MP3 playlists• WAV format• AAC format
Recording Format Compatibility	<ul style="list-style-type: none">• ISO9660 level 1 & level 2• Yellow book MODE 1 & MODE 2 FORM 1• Multi session
Sampling Frequency Rate Compatibility	<ul style="list-style-type: none">• MP3: 8kHz - 48kHz• WMA: 32kHz - 48kHz
Transfer Bit Rate Compatibility	<ul style="list-style-type: none">• MP3: 32kbps - 320kbps• WMA: 32kbps - 192kbps
Character Support	<ul style="list-style-type: none">• Song Title: 30 characters• Artist Name: 30 characters• Album Name: 30 characters• File Name: 32 characters• Folder Name: 32 characters
ID3 Tag Support	<ul style="list-style-type: none">• MP3 Tags: Version 1.0 - 2.0• WMA Tags
File/Folder Limit	<ul style="list-style-type: none">• Maximum folders and files: 256• Maximum folder levels: 8

XDMA7100

SD Card / USB Operation

Connect a USB Device (sold separately)

To play MP3/WMA files from most USB mass storage devices, line up the USB connector and insert the USB device into the XDMA7100's USB port.







Inserting an SD Card (sold separately)

To play MP3/WMA files from an SD card, insert the card horizontally with the label facing up into the SD card slot located behind the front panel.

Playing Music

When a USB device is first connected, "READING" will appear in the display and playback will begin momentarily. To begin playing music from an SD card, press **MODE** to select SD mode and begin playback. Depending on the number of files and folders, it may take several seconds for the device to begin playing. If no valid MP3/WMA files are detected, "NO FILE" will be displayed and the last mode will be resumed.



Track Select

Press **TRACK**   to skip to the beginning of the next track. Press **TRACK**   to return to the beginning of the current track. Pressing **TRACK**   again skips to the beginning of the previous track.

Fast Forward and Reverse

Press and hold **TRACK**   or **TRACK**   to fast forward or reverse a track.

Pause

Press  to temporarily stop USB playback. Press  again to resume playback.

File Search Step 1

Press **SELECT** to enter the file/folder search mode. A list of all the folders from the USB device or SD card will be displayed.

Note: Any files located in the root directory will be located in the folder named "ROOT". Press **SELECT** to view the files on the root folder.

Step 2

Turn the **volume knob** to cycle through all the folders on the device and press **SELECT** to choose the desired folder. The list of files in the selected folder will be displayed. Turn the **volume knob** to cycle through the list of files.

Note: Pressing **ESC** when viewing the contents of a folder will return to the list of folders on the USB/SD device. Press **ESC** again to exit the search menu.

Step 3

Once the desired song is displayed, press **SELECT** to begin playback of the desired song.

Note: Due to differences in USB device and SD card transfer speeds, it is recommended to limit each folder to less than 30 songs.

SD Card / USB Operation

Displaying Information

When a file is accessed, the clock and elapsed time will be displayed. Press **DISP** momentarily to select between sort title, artist, file name, folder name, track number and clock/elapsed time.

"NO TITLE" will be displayed if no song title information is available.

"NO ARTIST" will be displayed if no artist information is available.

Song Title Icon

This icon will illuminate when the song title is displayed.

Artist Icon

This icon will illuminate when the artist name is displayed.

Folder Icon

This icon will illuminate when the folder name is displayed.

File Icon

This icon will illuminate when the file name is displayed.

Folder Access

Press  to select the previous folder.

Press  to select the next folder.

Note: Folder access is only available on devices with more than one folder.

Repeat

Press **RPT** to enter the Repeat menu, then turn the **volume knob** to select one of the following options:

- OFF - Plays all tracks on the device.
- TRACK - Continuously repeats selected track.
- FOLDER - Continuously repeats all files in selected folder.

Random

Press **RDM** to enter the Random menu, then turn the **volume knob** to select one of the following options:

- OFF - Cancels the **RDM** function.
- ALL - Plays all tracks in random order.
- FOLDER - Plays all tracks in folder in random order.

Note: Random mode is retained in memory when selecting between other modes and when the unit is turned on/off.

Intro

Press **INT** to enter the Intro menu, then turn the **volume knob** to select one of the following options:

- OFF - Cancels the **INT** function.
- ALL - Plays first 10 seconds of each track.
- FOLDER - Plays first 10 seconds of each track in folder.

XDMA7100

SD Card / USB Operation

File/Folder Compatibility and Support

Compatible File Types	<ul style="list-style-type: none">• CD-ROM (ISO), CD-R, CD-RW• CD-DA (digital audio)• MP3 data [.mp3]• WMA data [.wma]
Incompatible File Types	<ul style="list-style-type: none">• DRM protected files• WMA lossless• Apple lossless• WMA Pro• MP3 Pro• MP3 playlists• WAV format• AAC format
Recording Format Compatibility	<ul style="list-style-type: none">• ISO9660 level 1 & level 2• Yellow book MODE 1 & MODE 2 FORM 1• Multi session
Sampling Frequency Rate Compatibility	<ul style="list-style-type: none">• MP3: 8kHz - 48kHz• WMA: 32kHz - 48kHz
Transfer Bit Rate Compatibility	<ul style="list-style-type: none">• MP3: 32kbps - 320kbps• WMA: 32kbps - 192kbps
Character Support	<ul style="list-style-type: none">• Song Title: 30 characters• Artist Name: 30 characters• Album Name: 30 characters• File Name: 32 characters• Folder Name: 32 characters
ID3 Tag Support	<ul style="list-style-type: none">• MP3 Tags: Version 1.0 - 2.4• WMA Tags
File/Folder Limit	<ul style="list-style-type: none">• Maximum number of files: 65535• Maximum number of folders: 65535 (plus the root folder)• Maximum number of files in each folder: 65535• Maximum folder levels: 7 <p>Note: For devices with more than the maximum number of files/folders, some files will be ignored and may not function properly.</p>
USB/SD File System	<ul style="list-style-type: none">• FAT/FAT32 file system are supported.• HFS/NTFS/EXT2/EXT3 are not supported.
SD Card Capacity	16GB or less supported.

XDMA7100

Operation of iPod

Connect an iPod Device (Not Included)



The XDMA7100 features a direct USB control system for iPod. To play music from an iPod device, connect the USB cable (included with your iPod device) to the XDMA7100's USB port. Once connected, **READING** will appear in the display. Playback will begin automatically. If a song is playing on the iPod device before it is connected, it will continue to play.

Displaying Information

Press **DISP** to select between artist, song title, album, elapsed time, clock and track number.

Music Search Mode

Search Menu Functions (step 1)

Press **SELECT** once to enter the search mode.

(step 2)

Turn the **volume** knob to select between **playlist**, **artist**, **album**, **song**, **audiobook** and **podcast**. Press **SELECT** to select the desired search type.

(step 3)

Navigate to the desired song and press **SELECT** to begin playback of that song. Use the table below for reference when navigating through the menu options.

Note: Press **ESC** to access the previous level (up one level). Pressing **ESC** from the search main menu will exit the search.

See the below table for a list of the search menu navigation options.

Search Item	Menu Navigation
Playlist	Menu → Playlists → Songs
Artist	Menu → Artists → Albums → Songs
Album	Menu → Albums → Songs
Song	Menu → Songs
Audiobooks	Menu → Audiobooks
Podcast	Menu → Podcasts

Operation of iPod

Song Select	Press ▶▶ to skip to the beginning of next song. Press ◀◀ to return to the beginning of current song. Pressing ◀◀ again skips to the beginning of previous song.
Fast Forward and Reverse	Press and hold ▶▶ or ◀◀ to fast forward or reverse a song.
Pause	Press ▶/ to temporarily stop playback. Press ▶/ again to resume playback.
Repeat	Press RPT to enter the Repeat menu, then turn the volume knob to select one of the following options: <ul style="list-style-type: none">• OFF - Repeats all tracks.• SONG - Repeats selected track.
Random	Press RDM to enter the Random menu, then turn the volume knob to select one of the following options: <ul style="list-style-type: none">• OFF - Cancels the RDM function.• ALL - Plays all tracks in random order.• ALBUM - Plays all tracks in the selected album in random order.
Intro	Press INT to enter the Intro menu, then turn the volume knob to select one of the following options: <ul style="list-style-type: none">• OFF - Cancels the INT function.• ON - Plays first 10 seconds of each track.
Character Support	<p>Only alphanumeric characters can be displayed (ASCII type). "NO SUPPORT" will be displayed if the file contains characters that can not be displayed. "NO FILE" will be displayed if there are no songs in the selected playlist.</p> <p>Maximum character display information</p> <ul style="list-style-type: none">• *Song title – 32 character maximum• *Artist name – 32 character maximum• *Album name – 32 character maximum <p>*Song Title, Artist Name and Album name will only be displayed if included with the file.</p>
Device Compatibility	Made for <ul style="list-style-type: none">• iPod touch (4th generation)• iPod nano (6th generation)• iPod touch (3rd generation)• iPod nano (5th generation)• iPod touch (2nd generation)• iPod nano (4th generation)• iPod classic• iPod touch (1st generation)• iPod nano (3rd generation)• iPod nano (2nd generation)• iPod with video• iPhone 4• iPhone 3GS• iPhone 3G• iPhone

Limited One Year Warranty

This warranty gives you specific legal rights. You may also have other rights which vary from state to state.

Dual Electronics Corp. warrants this product to the original purchaser to be free from defects in material and workmanship for a period of one year from the date of the original purchase.

Dual Electronics Corp. agrees, at our option, during the warranty period, to repair any defect in material or workmanship or to furnish an equal new, renewed or comparable product (whichever is deemed necessary) in exchange without charges, subject to verification of the defect or malfunction and proof of the date of purchase. Subsequent replacement products are warranted for the balance of the original warranty period.

Who is covered? This warranty is extended to the original retail purchaser for products purchased from an authorized Dual dealer and used in the U.S.A.

What is covered? This warranty covers all defects in material and workmanship in this product. The following are not covered: software, installation/removal costs, damage resulting from accident, misuse, abuse, neglect, product modification, improper installation, incorrect line voltage, unauthorized repair or failure to follow instructions supplied with the product, or damage occurring during return shipment of the product. Specific license conditions and copyright notices for the software can be found via axxera.dualav.com.

What to do?

1. Before you call for service, check the troubleshooting guide in your owner's manual. A slight adjustment of any custom controls may save you a service call.
2. If you require service during the warranty period, you must carefully pack the product (preferably in the original package) and ship it by prepaid transportation with a copy of the original receipt from the retailer to an authorized service center.
3. Please describe your problem in writing and include your name, a return UPS shipping address (P.O. Box not acceptable), and a daytime phone number with your shipment.
4. For more information and for the location of the nearest authorized service center please contact us by one of the following methods:

- Call us toll-free at 1-866-382-5476
- E-mail us at cs@dualav.com

Exclusion of Certain Damages: This warranty is exclusive and in lieu of any and all other warranties, expressed or implied, including without limitation the implied warranties of merchantability and fitness for a particular purpose and any obligation, liability, right, claim or remedy in contract or tort, whether or not arising from the company's negligence, actual or imputed. No person or representative is authorized to assume for the company any other liability in connection with the sale of this product. In no event shall the company be liable for indirect, incidental or consequential damages.

XDMA7100

Troubleshooting

Problem	Cause	Action
Unit will not turn on (no power)	Yellow wire not connected or incorrect voltage Red wire not connected or incorrect voltage	Check connections for proper voltage (11-16VDC)
	Black wire not connected	Check connection to ground
	Fuse blown	Replace fuse
Unit has power (but no sound)	Speaker wires not connected	Check connections at speakers
	One or more speaker wires touching each other or touching chassis ground	Insulate all bare speaker wires from each other and chassis ground
Unit blows fuses	Yellow or red wire touching chassis ground	Check for pinched wire
	Speaker wires touching chassis ground	Check for pinched wire
	Incorrect fuse rating	Use fuse with correct rating
Excessive skipping	Unit is not mounted correctly or backstrap is not secure	Check mounting sleeve and backstrap support
	Physical defect in media (CD, CD-R or CD-RW)	Check media for scratches
ERROR-01 appears on display	Disc read error	Press eject or RESET
ERROR-02 appears on display	Focus error or disc is in upside down	Press eject or RESET
PROTECT appears on display	The WMA file is copy-protected by DRM (Digital Rights Management)	Write disc using WMA files that are not copy-protected
NO FILE appears on display	Selected file is not available in direct or alphanumeric search modes	Repeat search using valid parameters
INVALID appears on display	The file format is incompatible	Write disc using valid audio files with .mp3 or .wma file extensions
Unit will not accept a disc	CD mechanism position out of alignment	Press and hold EJECT for 3 seconds to reset CD mechanism position
	CD transit screws still in place	Remove 2 transit screws located on top of the unit
NO SUPPORT appears on display	An invalid ID3 tag version is present	Version 1.0 to 2.0 ID3 tags are supported.

XDMA7100

Specifications

CD Player	Frequency response: 10Hz - 20kHz Channel separation @ 1kHz: >65dB D/A converter: 1 Bit
FM Tuner	Tuning range: 87.5MHz - 107.9MHz Usable sensitivity: 8.5dBf 50dB quieting sensitivity: 10dBf Stereo separation @ 1kHz: 40dB Frequency response: 30Hz - 13kHz
AM Tuner	Tuning range: 530kHz - 1710kHz Usable sensitivity: 22uV Frequency response: 30Hz - 2.2kHz
USB/SD Card	File system: FAT, FAT32 File extensions support: .mp3, .wma SD Card maximum device capacity: 16GB
General	Speaker output impedance: 4 to 8 ohms Line output voltage: 2 Volts RMS Dimensions: 7" x 7" x 2" (178 x 178 x 51 mm)

Design and specifications subject to change without notice.



CEA-2006 Power Standard Specifications
(reference: 14.4VDC +/- 0.2V, 20Hz - 20kHz)

Power Output: 18 Watts RMS x 4 channels at 4 ohms and $\leq 1\%$ THD+N
Signal to Noise Ratio: 80dBA (reference: 1 watt into 4 ohms)

XDMA7100

FCC Compliance

This device complies with Part 15 of the FCC Rules. Operation is subject to the following two conditions:

(1) this device may not cause harmful interference, and

(2) this device must accept any interference received, including interference that may cause undesired operation.

Warning: Changes or modifications to this unit not expressly approved by the party responsible for compliance could void the user's authority to operate the equipment.

Note: This equipment has been tested and found to comply with the limits for a Class B digital device, pursuant to Part 15 of the FCC Rules. These limits are designed to provide reasonable protection against harmful interference in a residential installation. This equipment generates, uses and can radiate radio frequency energy and, if not installed and used in accordance with the instructions, may cause harmful interference to radio communications. However, there is no guarantee that interference will not occur in a particular installation. If this equipment does cause harmful interference to radio or television reception, which can be determined by turning the equipment off and on, the user is encouraged to try to correct the interference by one or more of the following measures:

- Reorient or relocate the receiving antenna.
- Increase the separation between the equipment and receiver.
- Connect the equipment into an outlet on a circuit different from that to which the receiver is connected.
- Consult the dealer or an experienced radio/TV technician for help.



Dual Electronics Corp.
Toll Free: 1-866-382-5476
axxera.dualav.com

©2011 Dual Electronics Corp. All rights reserved.

iPhone, iPod, iPod classic, iPod nano, and iPod touch are trademarks of Apple Inc., registered in the U.S. and other countries.

"Made for iPod" and "Made for iPhone" mean that an electronic accessory has been designed to connect specifically to iPod or iPhone, respectively, and has been certified by the developer to meet Apple performance standards. Apple is not responsible for the operation of this device or its compliance with safety and regulatory standards. Please note that the use of this accessory with iPod or iPhone may affect wireless performance.

The SD logo is a trademark of the SD Card Association.

Other trademarks and trade names are those of their respective owners.

NSA0211-V01