



LG

Life's Good

ENGLISH

OWNER'S MANUAL MONITOR TV

Please read this manual carefully before operating your set and retain it for future reference.

MONITOR TV MODELS

M2262D

M2362D

M2762D

PREPARATION

FRONT PANEL CONTROLS

- This is a simplified representation of the front panel. The image shown may be somewhat different from your set.

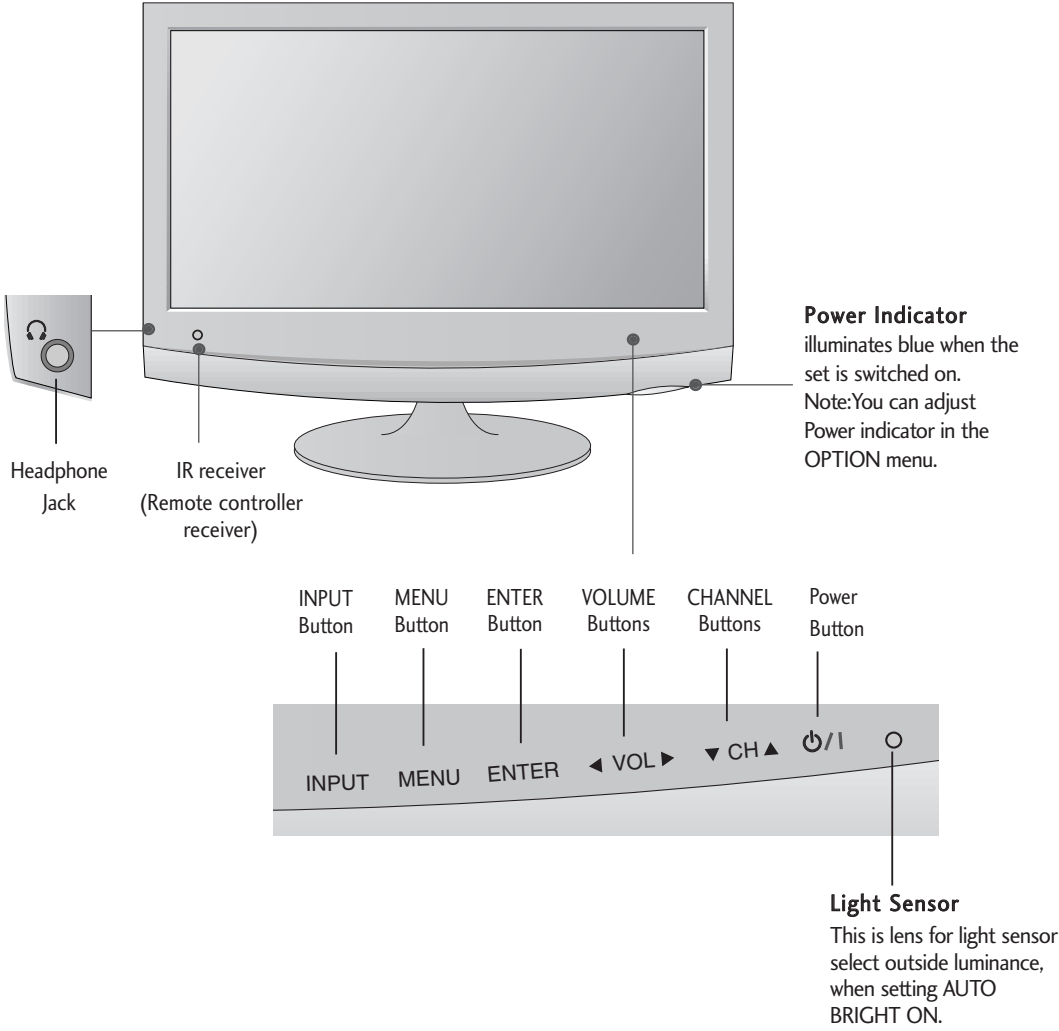

PREPARATION

BACK PANEL INFORMATION

- This is a simplified representation of the back panel. The image shown may be somewhat different from your set.

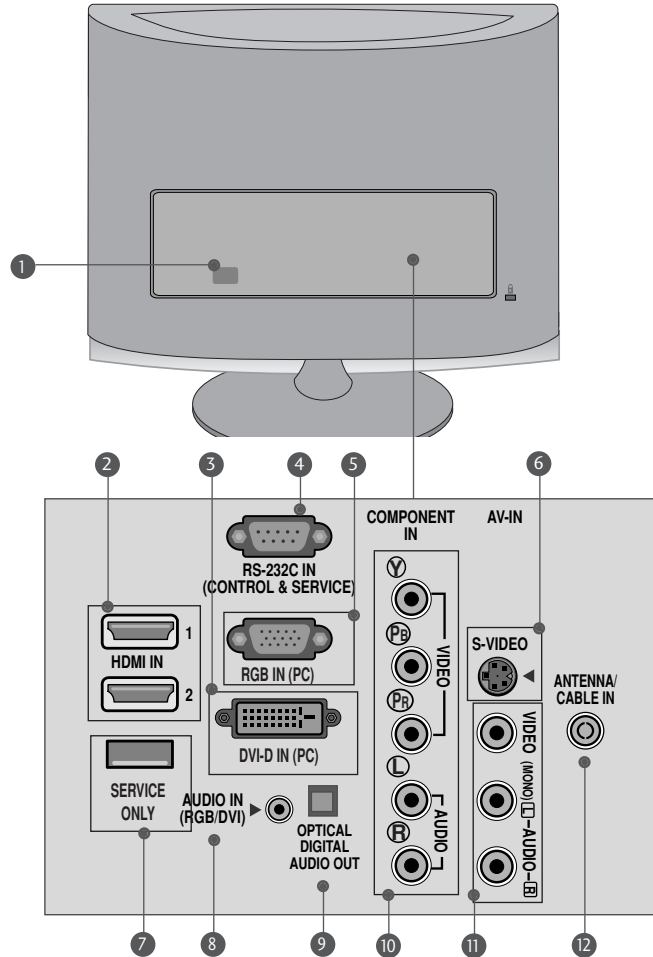

- 1** Power Cord Socket
This set operates on AC power. The voltage is indicated on the Specifications page. Never attempt to operate the set on DC power.
- 2** HDMI Input
High definition inputs. These two inputs accept TV Video, not PC Video. They also accept TV Video from a DVI connection when using an adapter. The HDMI inputs support video and audio. When using an adapter for DVI, they only accept video.
- 3** DVI-D Input
Digital PC input.
- 4** RS-232C IN (CONTROL & SERVICE) PORT
Serial port used for external control or service.
- 5** RGB INPUT (PC)
Analog PC input. Also known as VGA.
- 6** S-Video Input
Standard definition (480i), but better quality than standard A/V input.
- 7** SERVICE ONLY PORT
- 8** RGB/DVI Audio Input
This is the audio input for the RGB and DVI-D video inputs.
- 9** Optical Digital Audio Out
Use this to export audio to an external amplifier.
- 10** Component Input
High definition analog input.
- 11** Audio/Video Input
Standard definition input.
- 12** Antenna Input
Connect over-the-air or cable signals to this jack.

STAND INSTALLATION

■ The image shown may be somewhat different from your set.

- 1 Carefully place the product screen side down on a cushioned surface that will protect product and screen from damage.

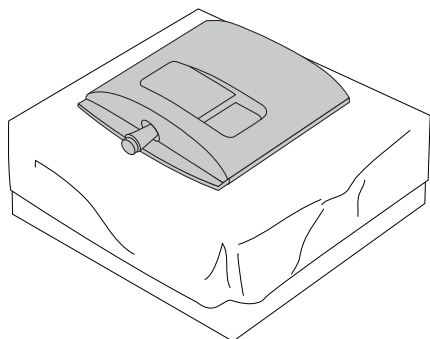

- 2 Insert the **stand base** into the product

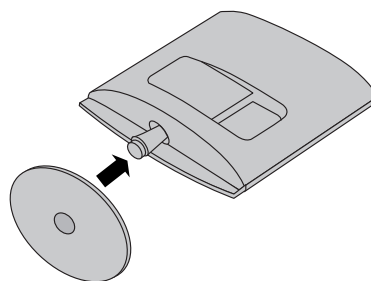

- 3 Turn the Stand Base Lock through 90° to fix the Stand Base to the Stand Body.

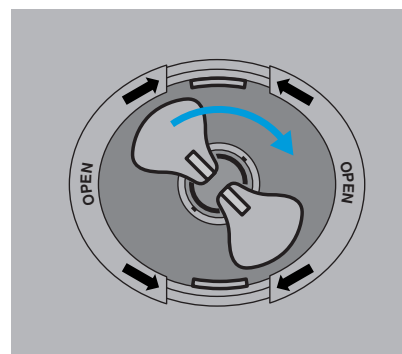
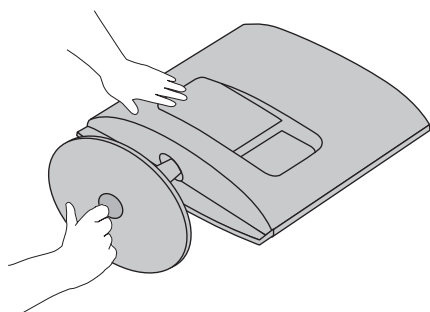

- 4 **Base Lock**

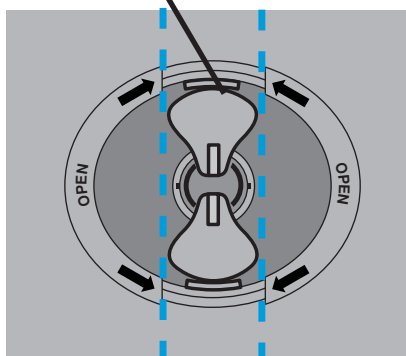

<Locked>

- 5

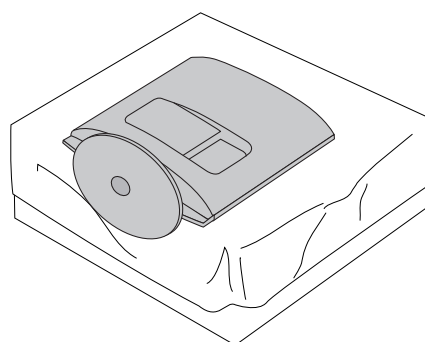

STAND INSTALLATION

■ The image shown may be somewhat different from your set.

- 1 Carefully place the product screen side down on a cushioned surface that will protect product and screen from damage.

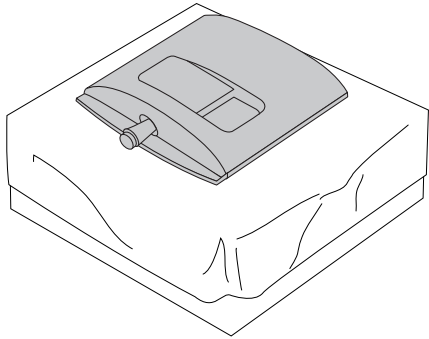

- 2 Insert the stand base into the product

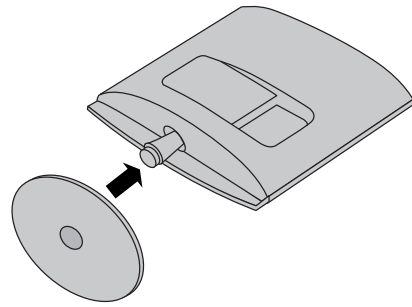

- 3 Attach the monitor to the Stand Base by turning the screw to the right.
*Turn the screw by using the screw handle

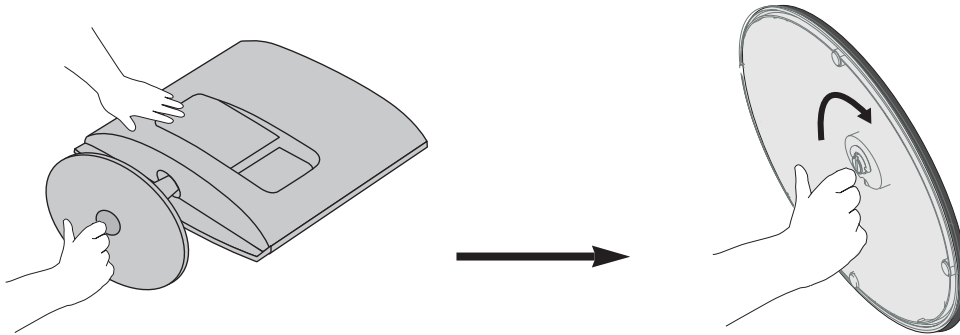

- 4

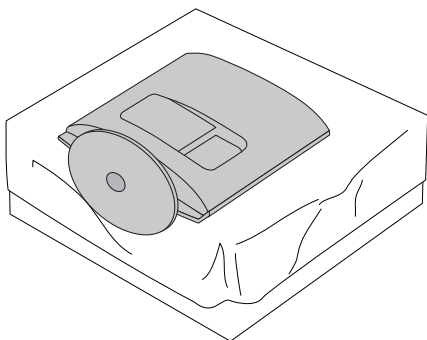

PREPARATION

<M2262D/M2362D>

DETACHING STAND

▪ The image shown may be somewhat different from your monitor.

1 Place the set screen side down on a cushion or soft cloth.

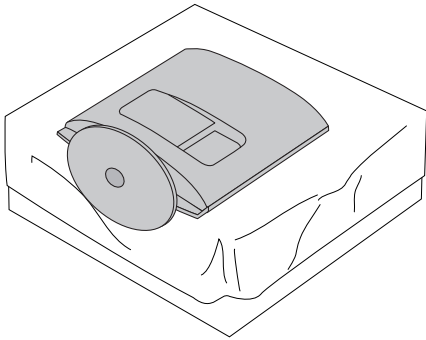

2 Detach the monitor to the Stand Base by turning the screw to the left.

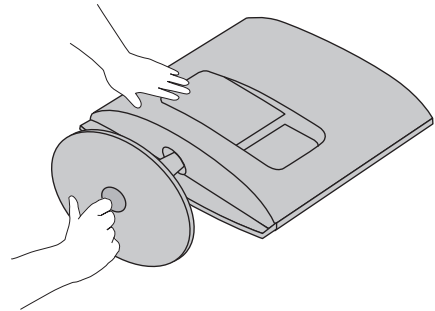

3 Turn the Stand Base Lock through 90° to separate the Stand Base from the Stand Body.

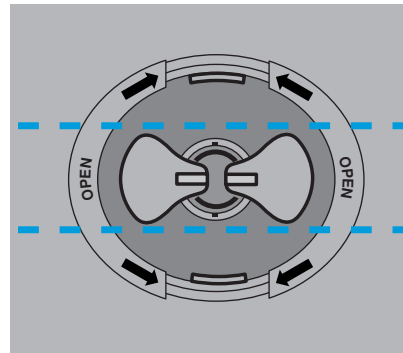
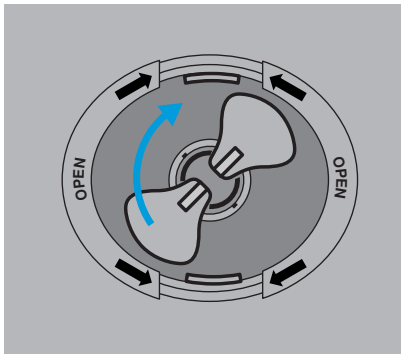

4 Pushing Latch inside, Take the stand base from stand body.

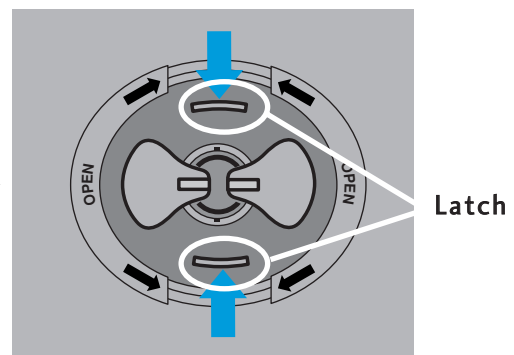
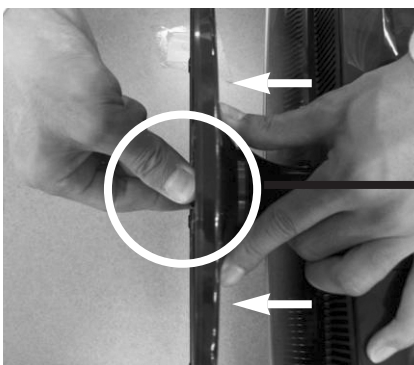

DETACHING STAND

■ The image shown may be somewhat different from your monitor.

- 1 Place the set screen side down on a cushion or soft cloth.

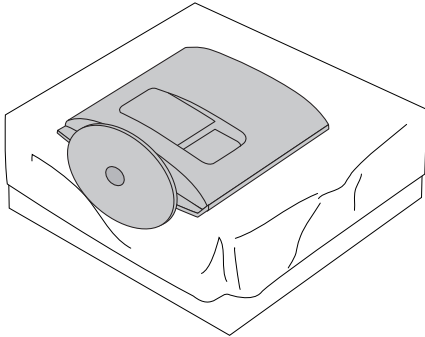

- 2 Detach the monitor to the Stand Base by turning the screw to the left.

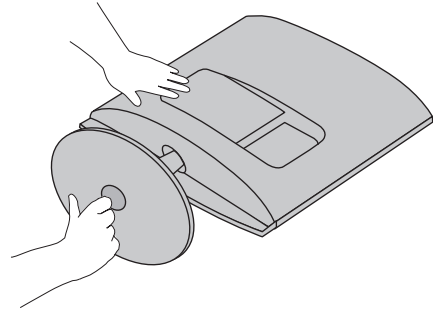

- 3 Turn the screw by using the screw handle.

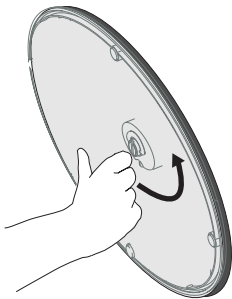

- 4 Pull the stand base.

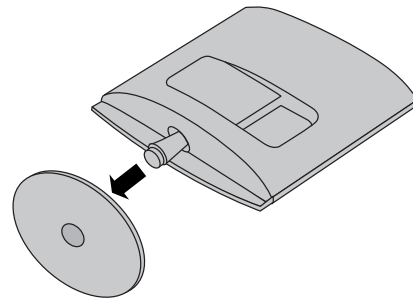

- 5

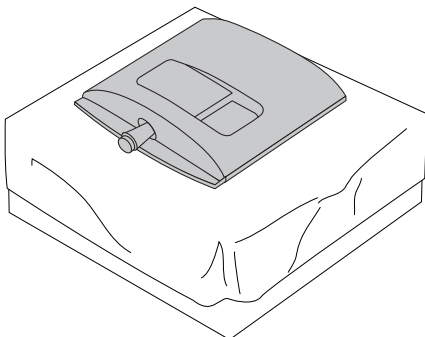

PREPARATION

DETACHING STAND BODY

- The image shown may be somewhat different from your set.
- Remove the Stand Body in the same way as the following when using it as a Wall Hook.

<M2262D/M2362D>

1. Remove the screw 2 point.
2. Pull the stand body.



<M2762D>

1. Remove the screw 4 point.
2. Pull the stand body.

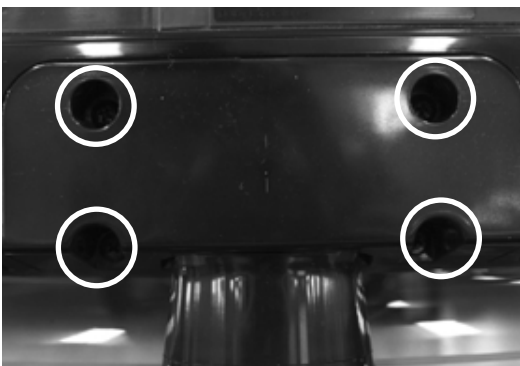

PREPARATION

WALL MOUNT: HORIZONTAL INSTALLATION

For proper ventilation, allow a clearance of 10 cm on each side and from the wall. Follow the instructions included with the wall mount.

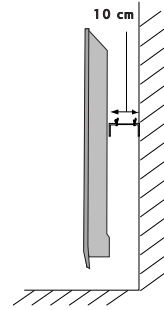
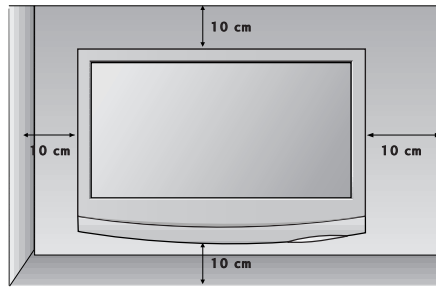
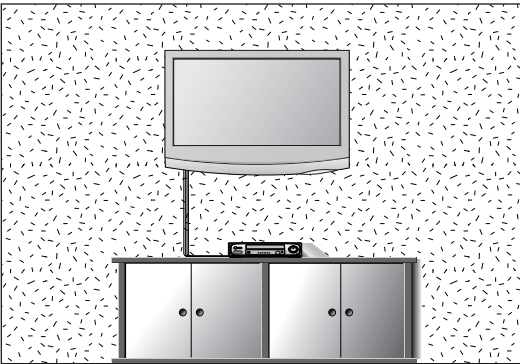

DESKTOP PEDESTAL INSTALLATION

For proper ventilation, allow a clearance of 10 cm on each side and from the wall.

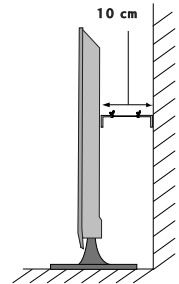
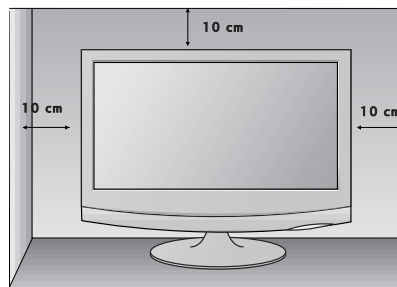
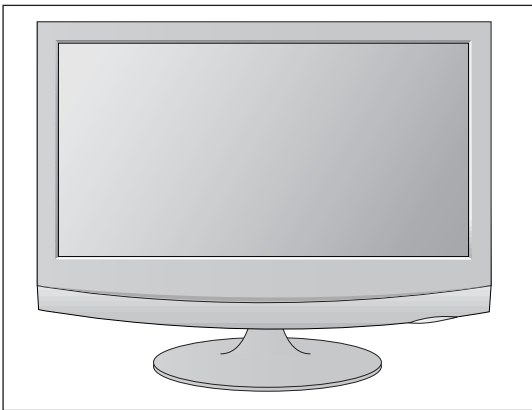

PREPARATION

POSITIONING YOUR DISPLAY

- The image shown may be somewhat different from your set.

Adjust the position of the panel in various ways for maximum comfort.

- **Tilt range**

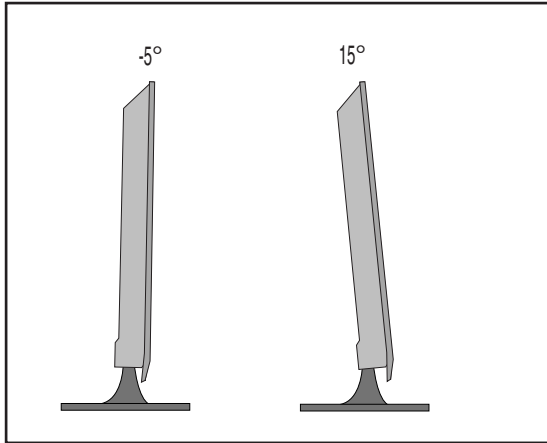

LOCATION

Position your set so that no bright light or sunlight falls directly onto the screen. Care should be taken not to expose the set to any unnecessary vibration, moisture, dust or heat. Also, ensure that the set is placed in a position to allow a free flow of air. Do not cover the ventilation openings on the back cover.

If you intend to mount the set to a wall, attach the wall mounting interface (optional parts) to the back of the set.

When you install the set using the wall mounting interface (optional parts), attach it carefully so it will not drop.

- Be sure to use screws and a wall mount that meet VESA standards.
- Using screws longer than those recommended might damage the product.
- Using screws that do not meet VESA standards might either damage the product or result in it coming away from the wall. We will not be held responsible for any damage resulting from failure to follow these instructions.

< Screw Mounting Interface Dimension >

M2262D/M2362D : 100 mm x 100 mm hole spacing

M2762D : 200 mm x 100 mm hole spacing

* Wall mount interface(LG) : RW120 <M2262D/M2362D>
RW240 <M2762D>

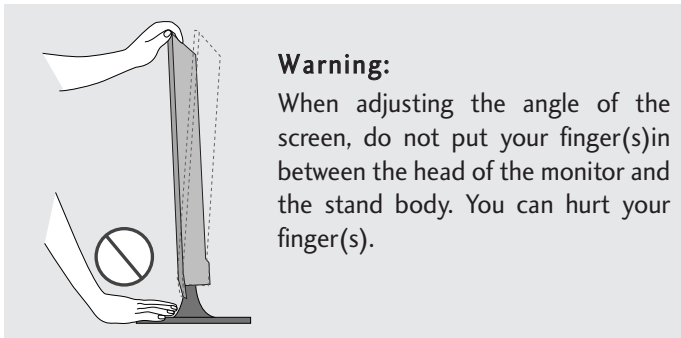

Warning:

When adjusting the angle of the screen, do not put your finger(s) in between the head of the monitor and the stand body. You can hurt your finger(s).

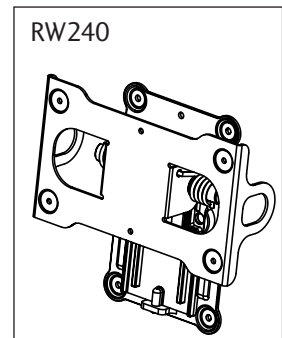
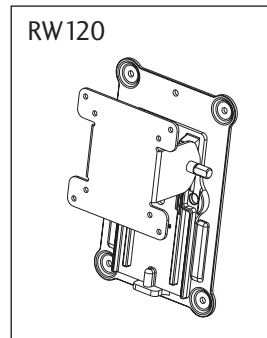

PREPARATION

SECURING THE SET TO THE WALL TO PREVENT FALLING WHEN THE SET IS USED ON A STAND

- Image shown may differ from your set.

We recommend that you set up the set close to a wall so it cannot fall over if pushed backwards. Additionally, we recommend that the set be attached to a wall so it cannot be pulled in a forward direction, potentially causing injury or damaging the product.

Caution: Please make sure that children don't climb on or hang from the set.

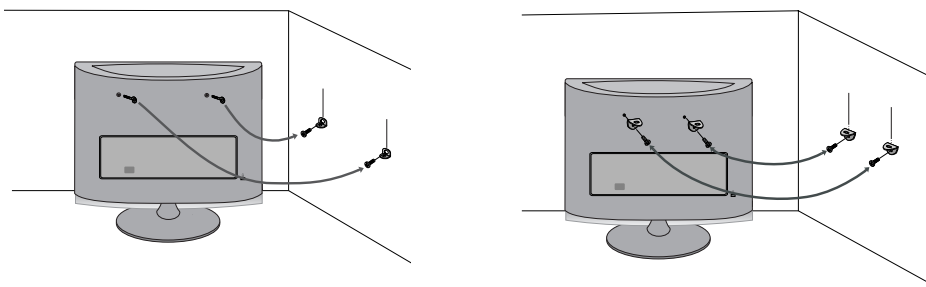

- Insert the eye-bolts (or set brackets and bolts) to tighten the product to the wall as shown in the picture.
 - * If your product has the bolts in the eye-bolts position before inserting the eye-bolts, loosen the bolts.
 - * Insert the eye-bolts or set brackets/bolts and tighten them securely in the upper holes.
- Secure the wall brackets with the bolts (sold separately) to the wall. Match the height of the bracket that is mounted on the wall to the holes in the product.
- Ensure the eye-bolts or brackets are tightened securely.

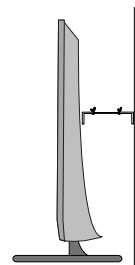

- Use a sturdy rope or cord (sold separately) to tie the product. It is safer to tie the rope so it becomes horizontal between the wall and the product.

! NOTE

- ▶ When moving the set, undo the cords first.
- ▶ Use a platform or cabinet strong enough and large enough to support the size and weight of the set.
- ▶ To use the set safely make sure that the height of the bracket on the wall and the one on the set are the same.

PREPARATION

ATTACHING THE TV TO A DESK (Only M2762D)

- Image shown may differ from your set.

The TV must be attached to desk so it cannot be pulled in a forward/backward direction, potentially causing injury or damaging the product. Use only an attached screw.

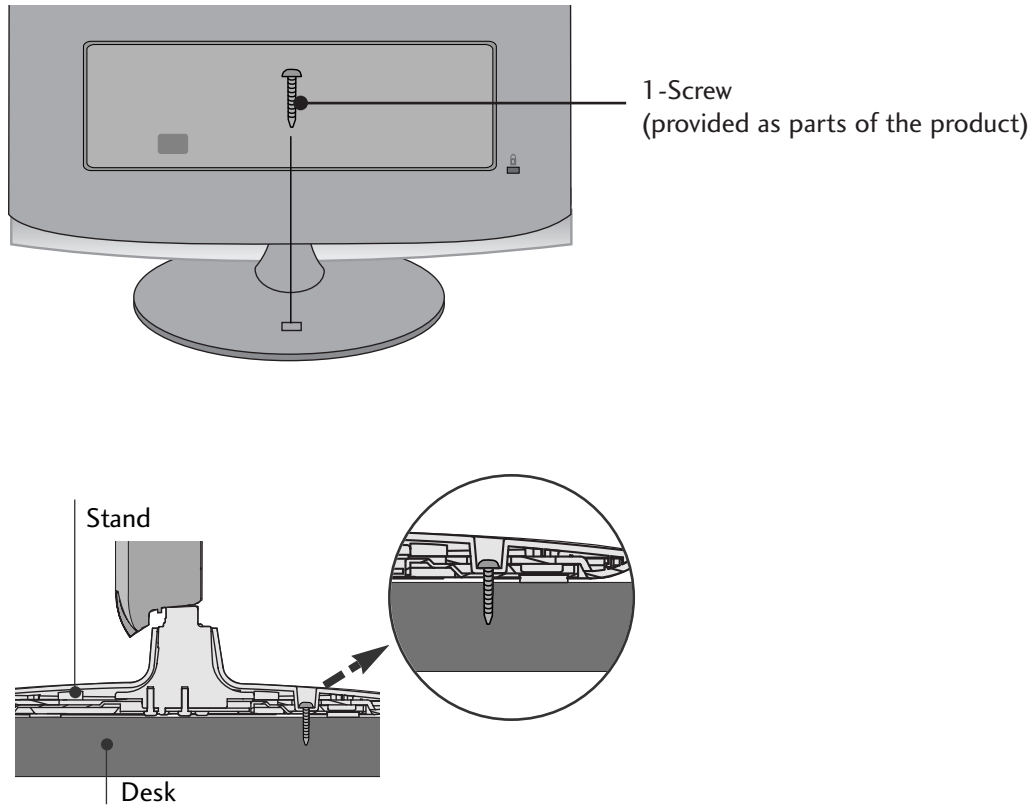

! WARNING

- ▶ To prevent TV from falling over, the TV should be securely attached to the floor/wall per installation instructions. Tipping, shaking, or rocking the machine may cause injury.

PREPARATION

KENSINGTON SECURITY SYSTEM

- The product is equipped with a Kensington Security System connector on the back panel. Connect the Kensington Security System cable as shown below.
- For detailed installation and use of the Kensington Security System, refer to the user's guide provided with the Kensington Security System.

For further information, contact <http://www.kensington.com>, the internet homepage of the Kensington company. Kensington sells security systems for expensive electronic equipment such as notebook PCs and LCD projectors.

NOTE

- The Kensington Security System is an optional accessory available at most electronics stores.

NOTES

- If the product feels cold to the touch, there may be a small "flicker" when it is turned on.
This is normal, there is nothing wrong with product.
- Some minute dot defects may be visible on the screen, appearing as tiny red, green, or blue spots. However, they have no adverse effect on the monitor's performance.
- Avoid touching the LCD screen or holding your finger(s) against it for long periods of time.

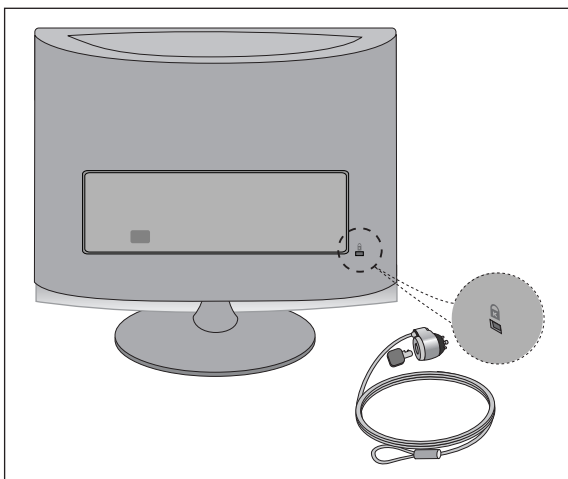

EXTERNAL EQUIPMENT SETUP

- To prevent equipment damage, never plug in any power cords until you have finished connecting all equipment.

ANTENNA CONNECTION

- For optimum picture quality, adjust antenna direction.
- An antenna cable and converter are not supplied.

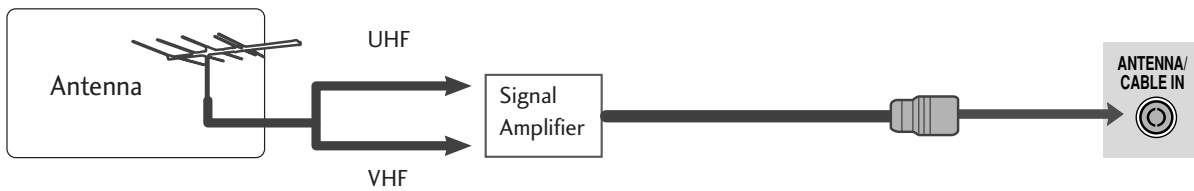
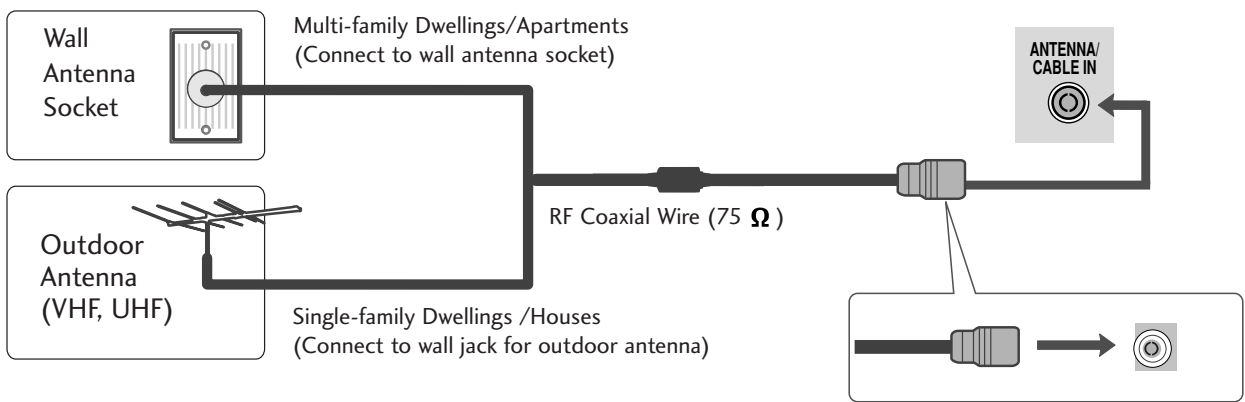

- In poor signal areas, to get better picture quality, install a signal amplifier to the antenna as shown above.
- If signal needs to be split for two TVs, use an antenna signal splitter for connection.

EXTERNAL EQUIPMENT SETUP

- To prevent the equipment damage, never plug in any power cords until you have finished connecting all equipment.
- The image shown may be somewhat different from your set.

HD RECEIVER SETUP

When connecting with a component cable

- 1 Connect the SET-TOP outputs to the **COMPONENT IN VIDEO** sockets (Y Pb Pr) on the set.
- 2 Connect the audio cable from the SET-TOP to **COMPONENT IN AUDIO** sockets of the set.
- 3 Press the **INPUT** button to select **Component**.

Signal	Component	HDMI
480i	Yes	No
480p	Yes	Yes
576p	No	Yes
720p/1080i	Yes	Yes
1080p	Yes	Yes

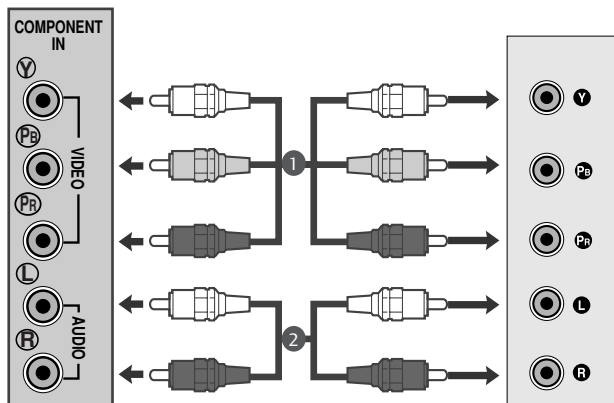

EXTERNAL EQUIPMENT SETUP

When connecting with a HDMI

- 1 Connect the HDMI output of the digital set-top box to the **HDMI IN** jack on the set.

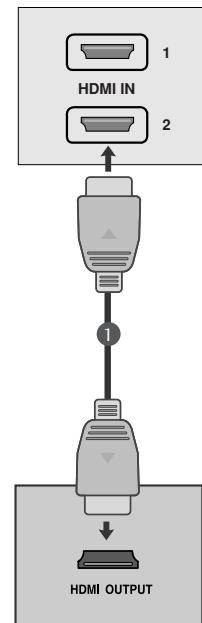

When connecting with a HDMI to DVI cable

- 1 Connect the digital set-top box to **HDMI IN** jack on the set.
- 2 Connect the audio output of the digital set-top box to the **AUDIO IN (RGB/DVI)** jack on the set.
- 3 Turn on the digital set-top box. (Refer to the owner's manual for the digital set-top box.)

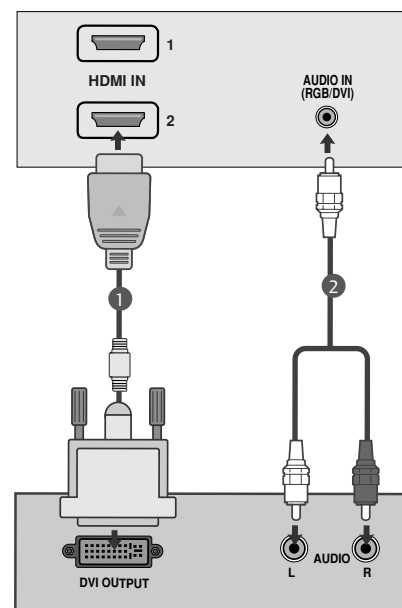

! NOTE

- ▶ HDMI Input does not support PC mode. If it is connected PC, the screen may not display properly.

EXTERNAL EQUIPMENT SETUP

DVD SETUP

When connecting with a component cable

- 1 Connect the video output sockets (Y P_B P_R) of the DVD to the **COMPONENT IN VIDEO** sockets (Y P_B P_R) of the set.
- 2 Connect the audio cable from the DVD to **COMPONENT IN AUDIO** sockets of the set.
- 3 Press the **INPUT** button to select **Component**.
- 4 Press the **PLAY** button on the DVD.
The DVD playback picture appears on the screen.

Component Input ports

To get better picture quality, connect a DVD player to the component input ports as shown below.

Component ports on the set	Y	P _B	P _R
Video output ports on DVD player	Y	P _B	P _R
	Y	B-Y	R-Y
	Y	Cb	Cr
	Y	Pb	Pr

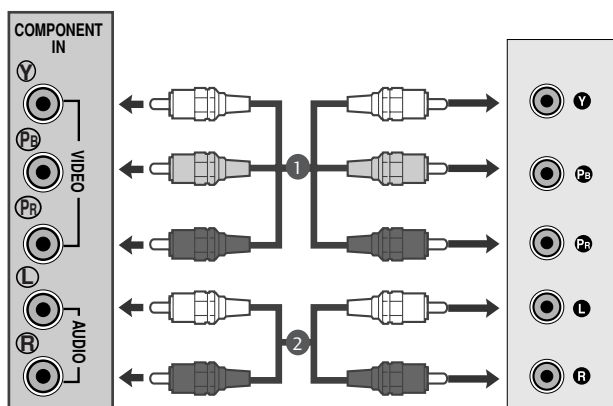

EXTERNAL EQUIPMENT SETUP

When connecting S-Video

- 1 Connect the S-Video output of the DVD to the S-Video in put on the set.
- 2 Connect the audio output of the DVD to the AUDIO in put on the set.

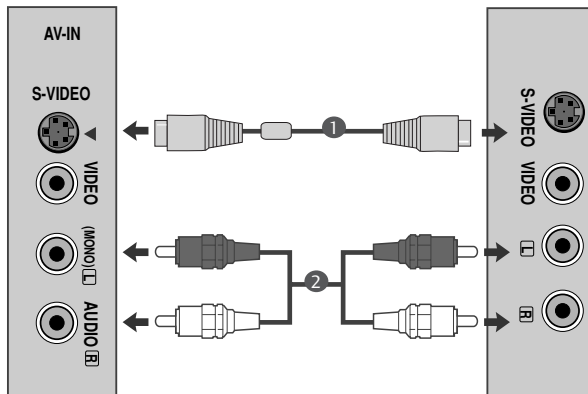

When connecting HDMI cable

- 1 Connect the HDMI output of the DVD to the **HDMI IN** jack on the set.

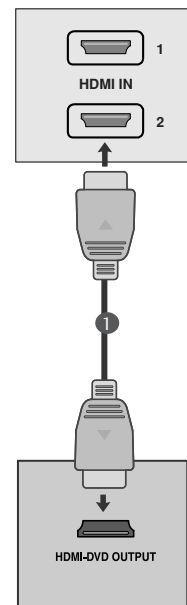

! NOTE

- ▶ HDMI supports video and audio. You do not need to connect a sperate audio cable.
- ▶ If the DVD player does not support Auto HDMI, you need to set the DVD output resolution appropriately.

EXTERNAL EQUIPMENT SETUP

VCR SETUP

- To avoid picture noise (interference), leave an adequate distance between the VCR and the set.
- If a user uses 4:3 picture format for a long time, an afterimage may remain on the sides of the screen for a short time.

When connecting with an antenna

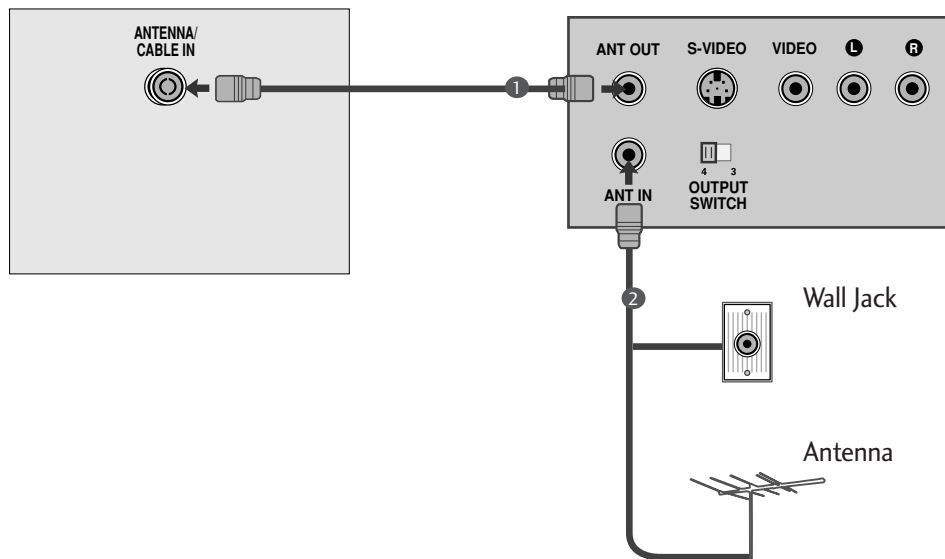

-
- 1 Connect the RF out socket of the VCR to the antenna socket of the set.
.....
 - 2 Connect the antenna cable to the RF aerial in socket of the VCR.
.....
 - 3 Store the VCR channel on a desired channel number using the 'Manual channel tuning' section.
.....
 - 4 Select the Channel number where the VCR channel is stored.
.....
 - 5 Press the **PLAY** button on the VCR.
-

EXTERNAL EQUIPMENT SETUP

When connecting with a RCA cable

- 1 Connect the audio/video out sockets of the VCR to AUDIO/VIDEO in sockets of the set.
- 2 Press the INPUT button to select AV.
- 3 Press the PLAY button on the VCR. The VCR playback picture appears on the screen.

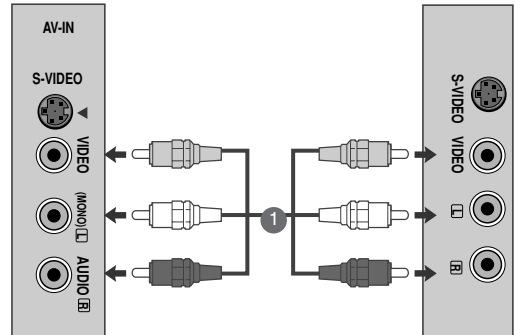

! NOTE

- ▶ If you have a mono VCR, connect the audio cable from the VCR to the AUDIO L/MONO jack of the set.

When connecting with an S-Video cable

- 1 Connect the S-Video socket of the VCR to the S-VIDEO socket of the set.
- 2 Connect the audio cable from the S-VIDEO of the VCR to the AUDIO sockets of the set.
- 3 Press the INPUT button to select AV.
- 4 Press the PLAY button on the VCR. The VCR playback picture appears on the screen.

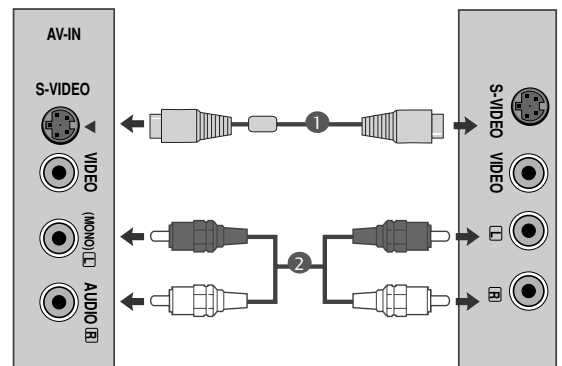

EXTERNAL EQUIPMENT SETUP

PC SETUP

This product provides Plug and Play capability, meaning that the PC adjusts automatically to the set's settings.

When connecting with a D-sub 15 pin cable

- 1 Connect the signal cable from the monitor output socket of the PERSONAL COMPUTER to the PC input socket of the set.
- 2 Connect the audio cable from the PC to the **AUDIO IN (RGB/DVI)** sockets of the set.
- 3 Press the INPUT button to select **RGB**.
- 4 Switch on the PC, and the PC screen appears on the set. The set can be operated as a PC monitor.

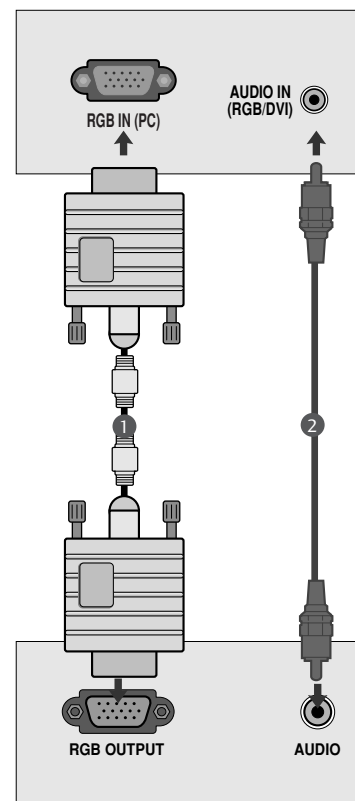

! NOTE

- ▶ User must use shielded signal interface cables (D sub 15 pin cable, DVI cable) with ferrite cores to maintain standard compliance for the product.

EXTERNAL EQUIPMENT SETUP

When connecting with a DVI cable

- 1 Connect the DVI output of the PC to the **DVI-D IN** jack on the set.
- 2 Connect the audio cable from the PC to the **AUDIO IN (RGB/DVI)** sockets of the set.

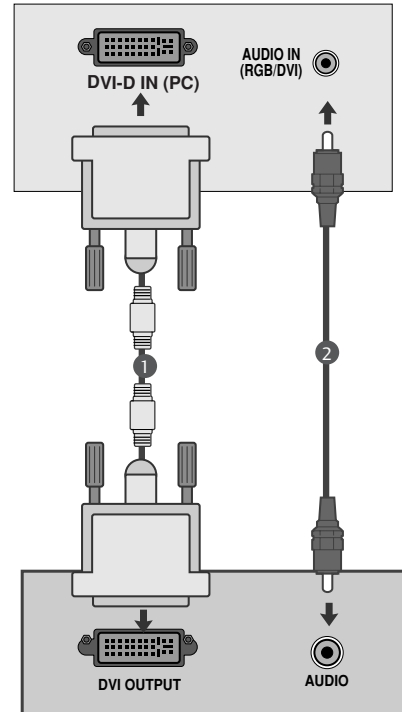

! NOTE

- ▶ If the set is cold, there may be a small “flicker” when the set is switched on. This is normal, there is nothing wrong with the set.
- ▶ If possible, use the 1920 x 1080 @ 60 Hz video mode to obtain the best image quality for your LCD monitor. If used with other resolutions, some scaled or processed pictures may appear on the screen. The set has been preadjusted to the mode 1920 x 1080 @ 60 Hz.
- ▶ Some dot defects may appear on the screen, like Red, Green or Blue spots. However, this will have no impact or effect on the monitor performance.
- ▶ Do not press the LCD screen with your finger for a long time as this may produce some temporary distortion effects on the screen.
- ▶ Avoid keeping a fixed image on the set’s screen for prolonged periods of time. The fixed image may become permanently imprinted on the screen; use a screen saver when possible.

EXTERNAL EQUIPMENT SETUP

BACK COVER FOR WIRE ARRANGEMENT

Tie cables together with a cable tie as shown in the illustration.

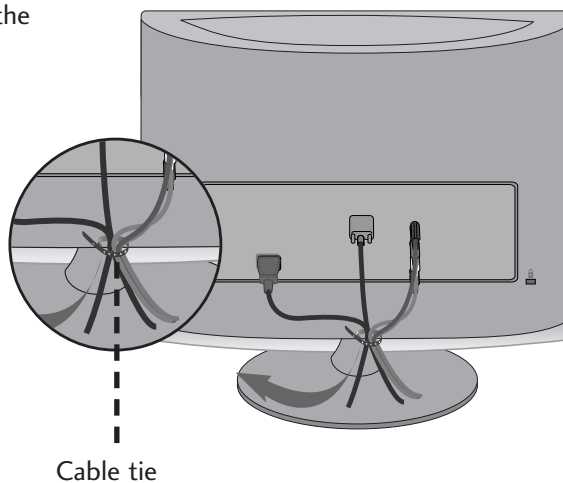

EXTERNAL EQUIPMENT SETUP

RGB/DVI[PC]

Resolution	Horizontal Frequency(kHz)	Vertical Frequency(Hz)
720x400	31.468	70
640x480	31.469	60
	37.500	75
800x600	37.879	60
	46.875	75
1024x768	48.363	60
	60.123	75
1152x864	67.500	75
1280x1024	63.981	60
	79.976	75
1680x1050	64.674	60
	65.290	60
1600x1200	75.000	60
1920x1080	66.587	60

HDMI[DTV] supported mode

Resolution	Horizontal Frequency(kHz)	Vertical Frequency(Hz)
720x480/60p	31.469	60
	31.5	60
720x576/50p	31.25	50
1280x720/50p	37.5	50
1280x720/60p	44.96	60
	45	60
1920x1080/60i	33.72	60
	33.75	60
1920x1080/50i	28.125	50
1920x1080/24p	27	24
1920x1080/30p	33.75	30
1920x1080/50p	56.25	50
1920x1080/60p	67.43	60
	67.5	60

EXTERNAL EQUIPMENT SETUP

INITIAL SETTING

This Function guides the user to easily set the essential items for viewing the TV for the first time when purchasing the TV. It will be displayed on the screen when turning the TV on for the first time. It can also be activated from the user menus.

- Default selection is **“Home”**. We recommend setting the TV to **“Home”** mode for the best picture in your home environment.
- **“In-store”** Mode is only intended for use in retail environments. Customers can adjust the **“Picture menu - Picture mode”** manually while inspecting the TV, but the TV will automatically return to preset in-store mode after 5 minutes.

Step1. Mode setting

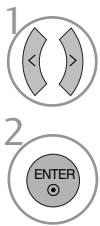
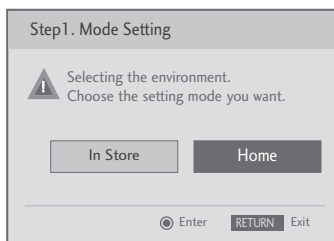

Select **Home** Mode.

Step2. Time setting

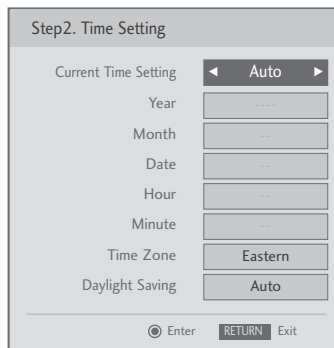

Select **Auto** or **Manual**.

Select desired time option.

Step3. Option setting

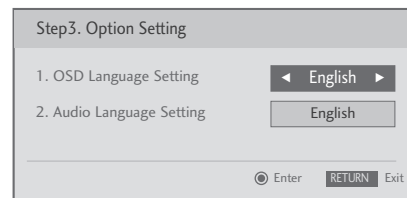

Select **OSD Language Setting** or **Audio Language Setting**.

Select your desired language.

Step4. Auto Tuning

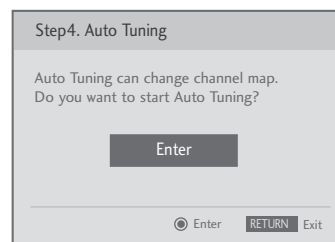

Start **Auto Tuning**.

! NOTE

- ▶ You can also adjust **Initial Setting** in the **OPTION** menu.

WATCHING TV / CHANNEL CONTROL

REMOTE CONTROL KEY FUNCTIONS

When using the remote control, aim it at the remote control sensor on the set.

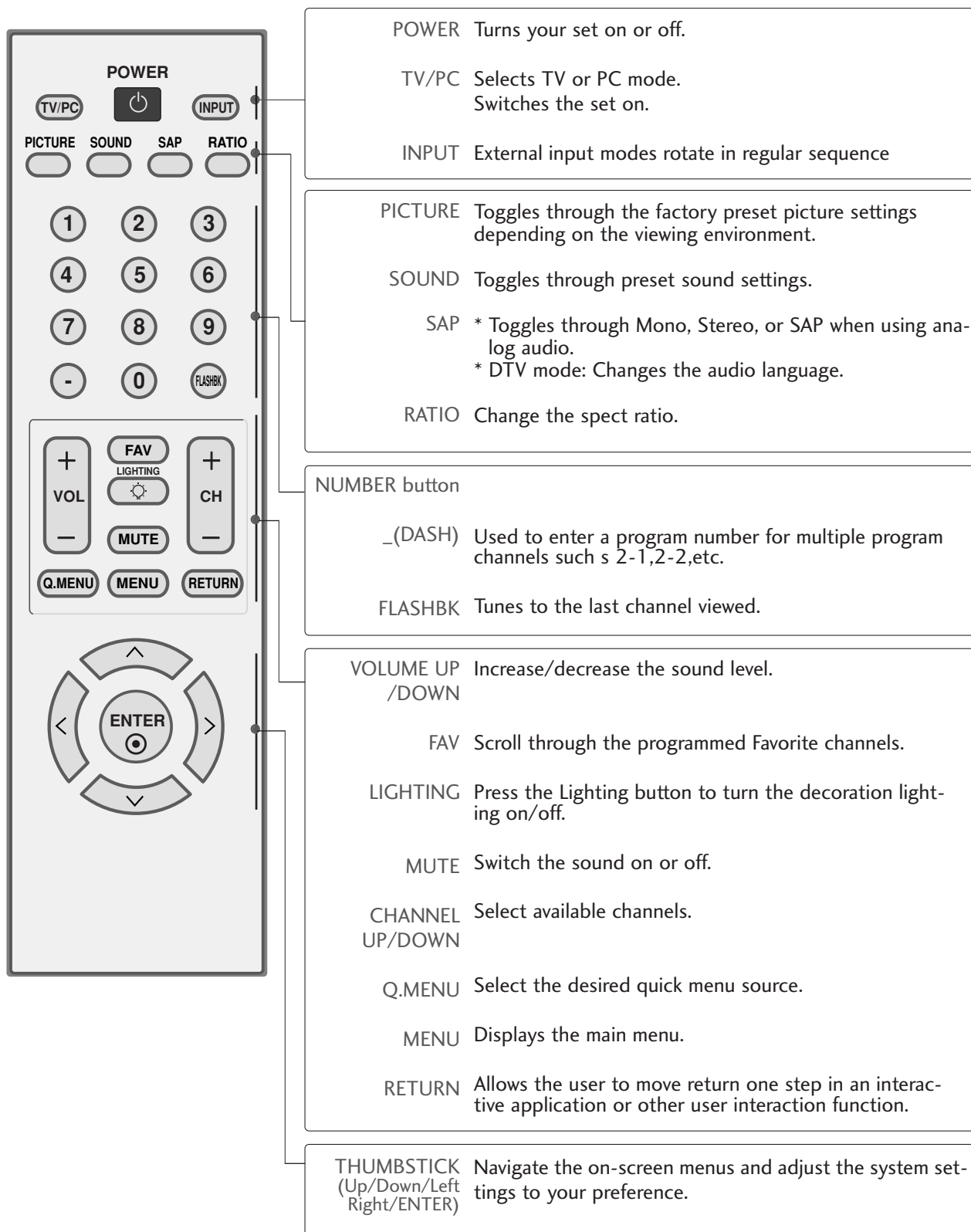

WATCHING TV / CHANNEL CONTROL

TURNING ON THE TV

- 1 First, connect the power cord correctly.
- 2 Turn on the power by pressing the power button on the product.
- 3 Press the TV/PC button on the remote control.
- 4 Set the channel by using the CH + / - buttons or number buttons on the remote control.

Setup Menu

If the OSD (On Screen Display) is displayed on the screen as figure after turning on the set, you can adjust the Language, Country, Time Zone, Auto channel tuning.

Note:

- a. It will automatically disappear after approx. 40 seconds unless a button is pressed.
- b. Press the **RETURN** button to change current OSD into regular OSD.



Installing Batteries

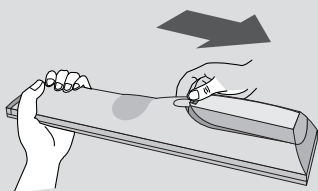

- Open the battery compartment cover on the back and install the batteries matching correct polarity (+ with +, - with -).
- Install two 1.5 V AAA batteries. Don't mix old or used batteries with new ones.
- Close cover.
- To remove the batteries, perform the installation actions in reverse.

WATCHING TV / CHANNEL CONTROL

CHANNEL SELECTION

- 1 Press the **CH +** or **-** or **NUMBER** buttons to select a programme number.
-

VOLUME ADJUSTMENT

- 1 Press the **VOL +** or **-** button to adjust the volume.

.....
If you want to switch the sound off, press the **MUTE** button.
.....

You can cancel this function by pressing the **MUTE**, **VOL +** or **-**.



WATCHING TV / CHANNEL CONTROL





QUICK MENU / FAVORITE CHANNEL SETUP

Your set's OSD (On Screen Display) may differ slightly from what is shown in this manual.

Q.Menu (Quick Menu) is a menu of features which users might use frequently.

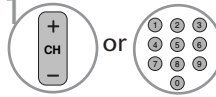
- **Aspect Ratio:** Selects your desired picture format.
- **Backlight:** Adjust the brightness of the LCD panel to control the brightness of the screen and lower power consumption.
- **Picture Mode:** Toggles through picture settings.
- **Sound Mode:** Toggles through sound settings.
- **Caption:** Select on or off.
- **Multi Audio:** Changes the audio language (Digital signal).
SAP: Selects MTS sound (Analog signal).
- **Sleep Timer:** Select the amount of time before your TV turns off automatically.
- **Del/Add/Fav:** Select channel you want to add/delete or add the channel to the Favorite List.

Favorite Channle Setup

- 1  or  Select your desired channel.
- 2   Select **Del/Add/Fav**.
- 3  Select **Favorite**.

■ To tune to a favorite channel, press the **FAV** (Favorite) button repeatedly.



1   Display each menu.

2  Make appropriate adjustments.





- Press the RETURN button to move to the previous menu screen.

WATCHING TV / CHANNEL CONTROL

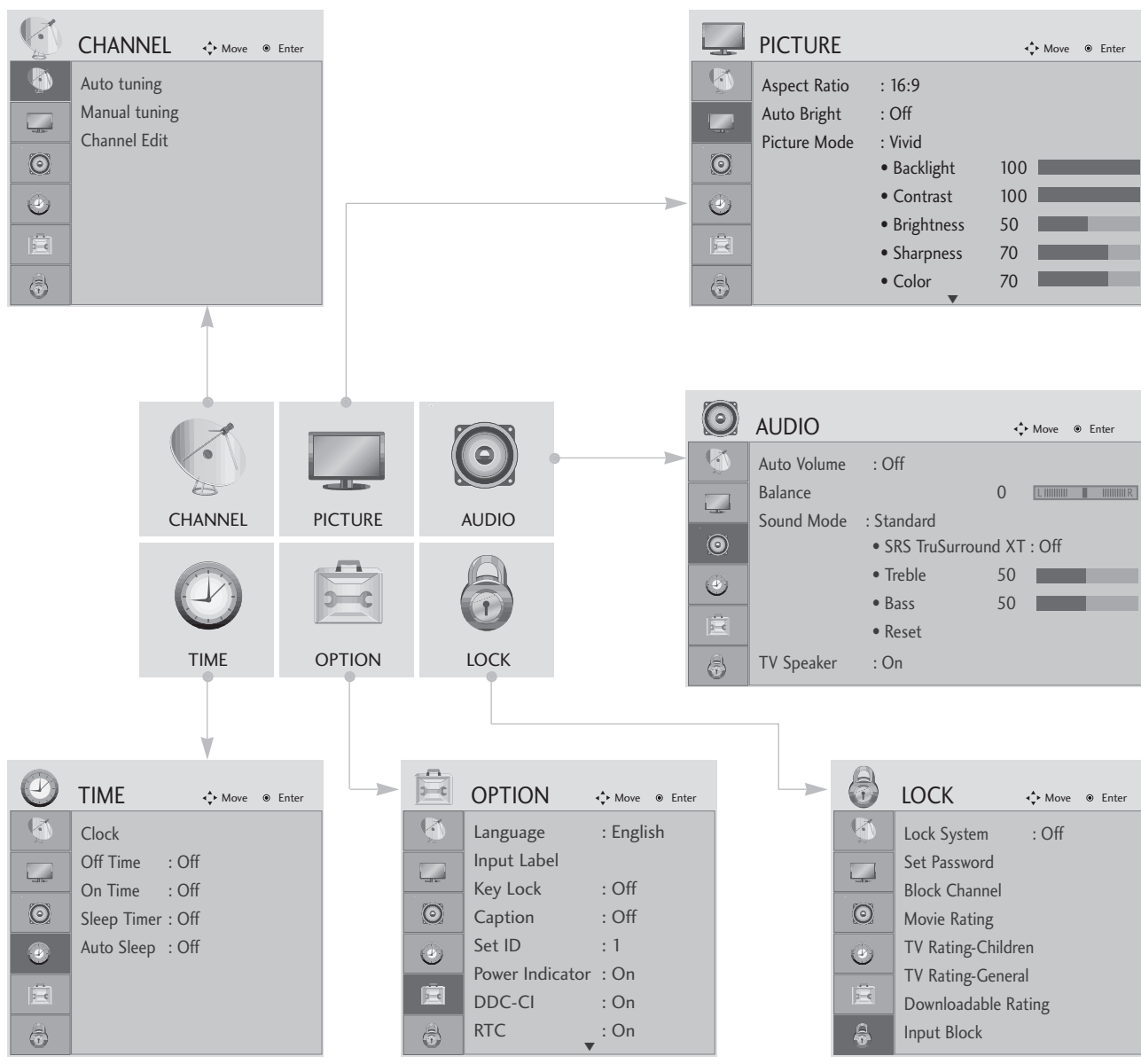
ON SCREEN MENUS SELECTION AND ADJUSTMENT

Your set's OSD (On Screen Display) may differ slightly from what is shown in this manual.



- 1   Display each menu.
- 2   Select a menu item.
- 3  Move to the pop up menu.

- Press the MENU button to close the menu window.
- Press the RETURN button to move to the previous menu screen.





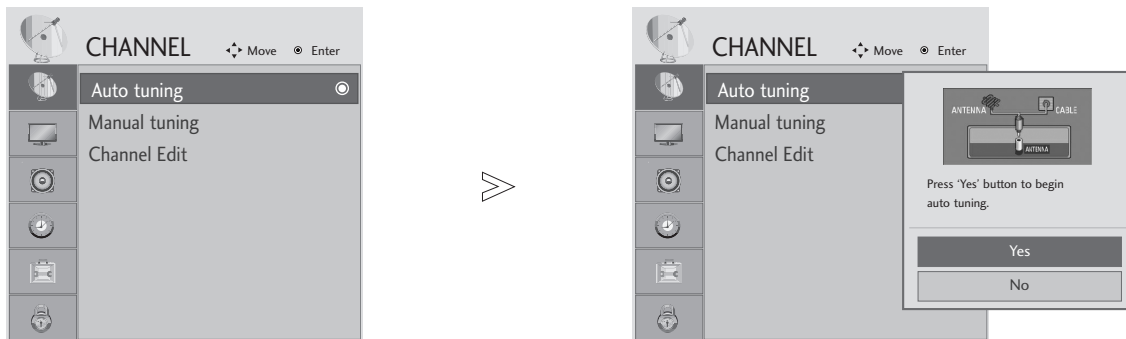

WATCHING TV / CHANNEL CONTROL

AUTO CHANNEL TUNING

Use this to automatically find and store all available channels.

When you start auto programming in digital mode, all previously stored service information will be deleted.



- 1   Select CHANNEL.
- 2   Select Auto Tuning.
- 3   Select Yes.
- 4  Run Auto tuning.

- Use the NUMBER buttons to input a 4-digit password in Lock System 'On'.
- If you wish to keep on auto tuning, select YES using the ◀ ▶ button. Then, press the ENTER button. Otherwise, select NO.

- Press the MENU button to close the menu window.
- Press the RETURN button to move to the previous menu screen.

WATCHING TV / CHANNEL CONTROL

MANUAL TUNING

When selecting DTV or TV or CADTV or CATV input signal, you can view the on-screen signal strength monitor to see the quality of the signal being received.

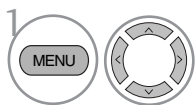
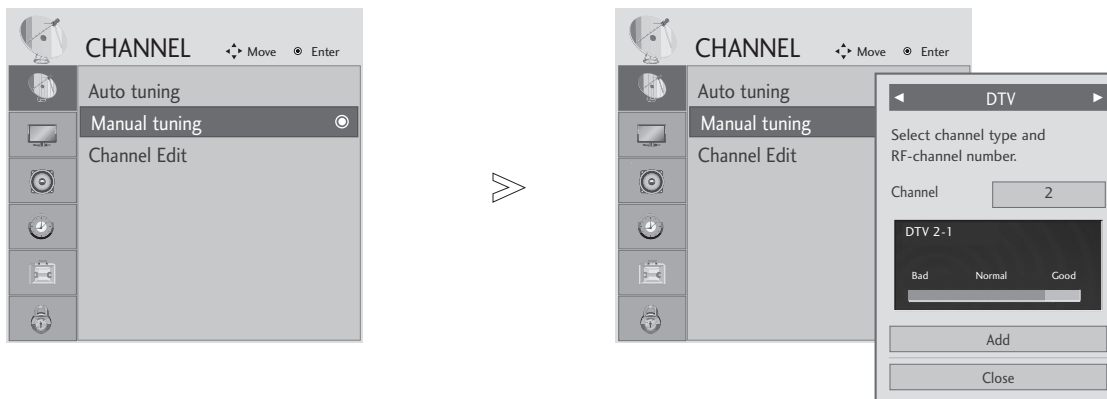

Select CHANNEL.

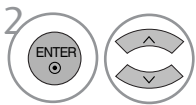

Select Manual Tuning.

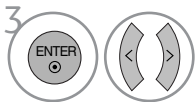

Select DTV, TV, CADTV, or CATV.

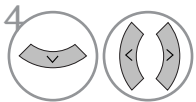

Select the channel you want to add or delete.

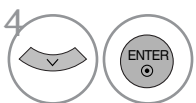

Select **Add** or **Delete**.

■ A password is required to gain access to the Manual Tuning menu if the Lock System is turned on.

- Press the MENU button to close the menu window.
- Press the RETURN button to move to the previous menu screen.

WATCHING TV / CHANNEL CONTROL

CHANNEL EDIT

A custom list can be created by toggling each channel on or off with the ENTER button.

The channels in the Custom List are displayed in black and the channels deleted from the Custom List are displayed in gray.

Once a channel is highlighted you can add or delete the channel by pressing the enter button.

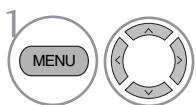
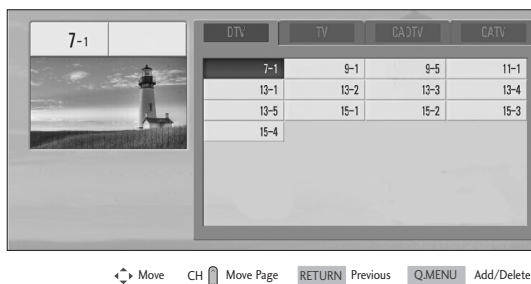
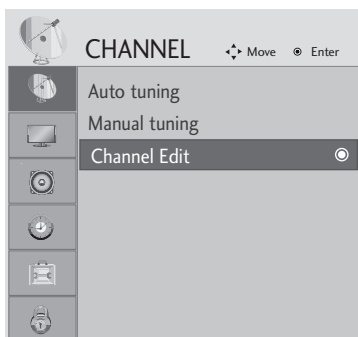

Select CHANNEL.

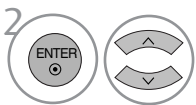

Select Channel Edit.



Select a **Channel**.



Select channel you want to add or delete.

- Press the MENU button to close the menu window.
- Press the RETURN button to move to the previous menu screen.

PICTURE CONTROL

PICTURE SIZE (ASPECT RATIO) CONTROL

This feature lets you choose the way an analog picture with a 4:3 aspect ratio is displayed on your set.

- RGB-PC input source use 4:3 or 16:9 aspect ratio.

! NOTE

- ▶ If a fixed image is displayed on the screen for a long time, the image could become imprinted on the screen and remain visible.
This phenomenon is common to all manufacturers and is not covered by warranty. Although, after watching video that did not fill the screen, any after-image from the black bars will normally dissipate after a few minutes.

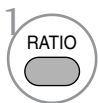
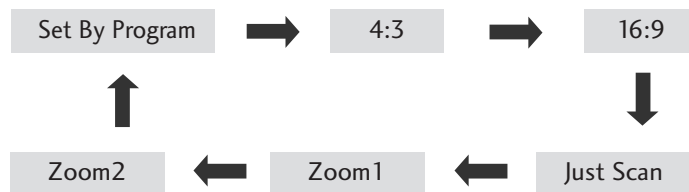
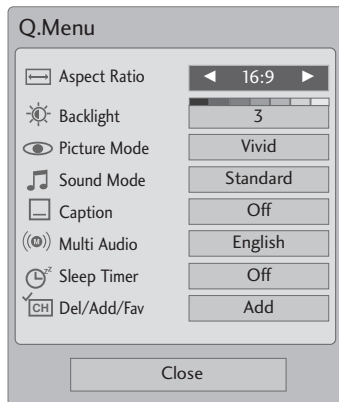

Select the desired picture format.

- Press the RETURN button to move to the previous menu screen.

PICTURE CONTROL

Set by program

Selects the proper picture proportion to match the source's image.



4:3

Choose 4:3 when you want to view a picture with an original 4:3 aspect ratio.



• 16:9

Adjust the picture horizontally, in a linear proportion to fill the entire screen.



Zoom 1

Choose Zoom 1 when you want to view the picture without any alteration. However, the top and bottom portions of the picture will be cropped.

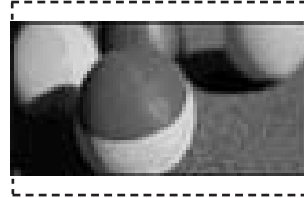

Zoom 2

Choose Zoom 2 when you want the picture to be altered, both vertically extended and cropped. The picture taking a halfway trade off between alteration and screen coverage.

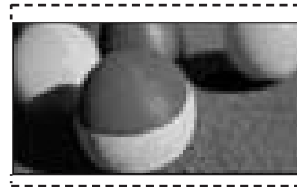

Just Scan

Following selection will lead to you view the picture of best quality without loss of original picture in high resolution image.

Notes: If there are noise in original picture, you can see the noise at the edge.

Just Scan operates only in DTV/CADTV/Component/HDMI-DTV/DVI-DTV (720p/1080i/1080p) input source.



PICTURE CONTROL

PRESET PICTURE SETTINGS

Picture Mode-Preset

There are factory presets for picture settings available in the user menus. You can use a preset, change each setting manually.

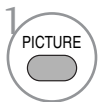
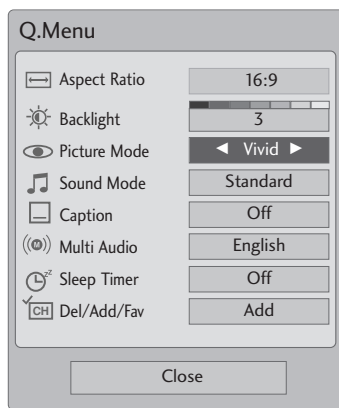

Select **Vivid**, **Standard**, **Cinema**, **Sport**, or **Game**.

- **Vivid**, **Standard**, **Cinema**, **Sport**, or **Game** Settings are preset for the optimum picture quality at the factory and are not adjustable.





- Press the RETURN button to move to the previous menu screen.

PICTURE CONTROL

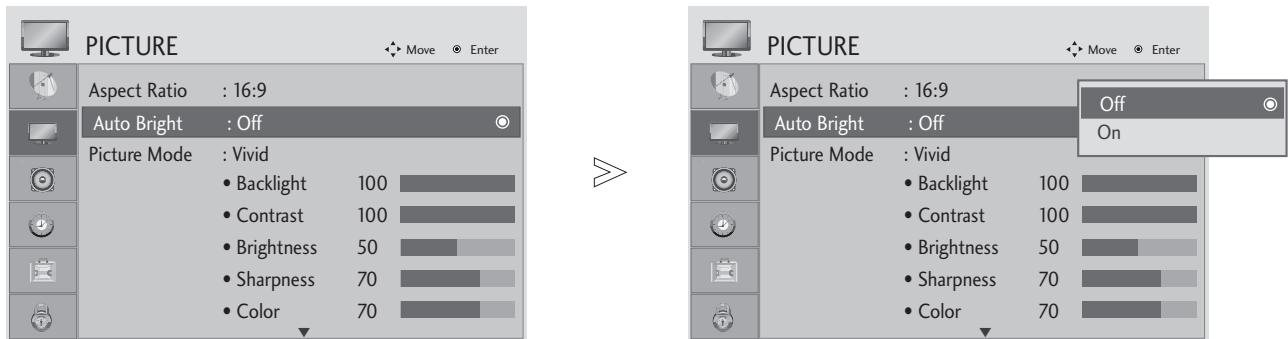
AUTO BRIGHT

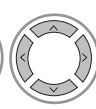
When ON is selected, this function adjusts the screen brightness automatically, depending on the surrounding environment, to provide optimal viewing conditions.
When OFF is selected, this function is turned off.

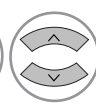

- 1   Select PICTURE.
- 2   Select **Auto Bright**.
- 3   Select On or Off.

- Press the MENU button to close the menu window.
- Press the RETURN button to move to the previous menu screen.

PICTURE CONTROL

PRESET PICTURE SETTINGS

Picture Mode-Preset

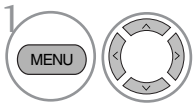
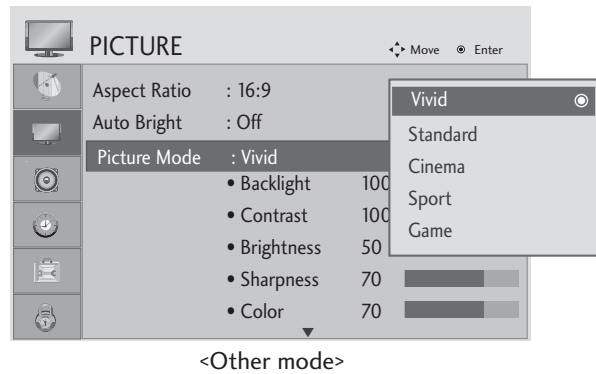
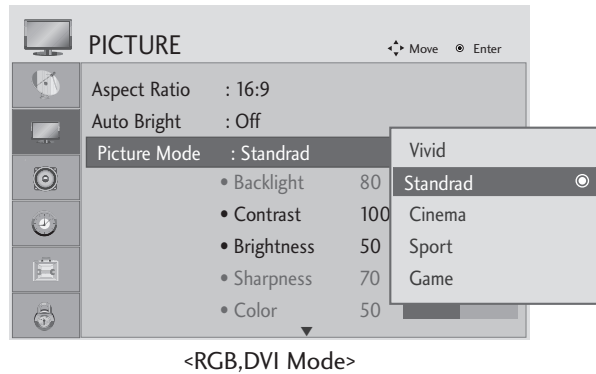
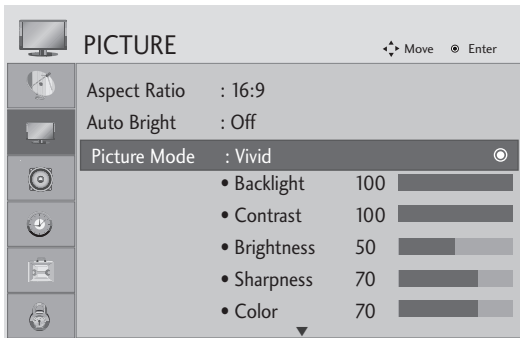

Select PICTURE.

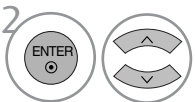

Select Picture Mode.

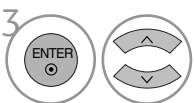

Select desired picture value.

• Picture Mode adjusts the set for the best picture appearance. Select the preset value in the Picture Mode menu based on the channel category.





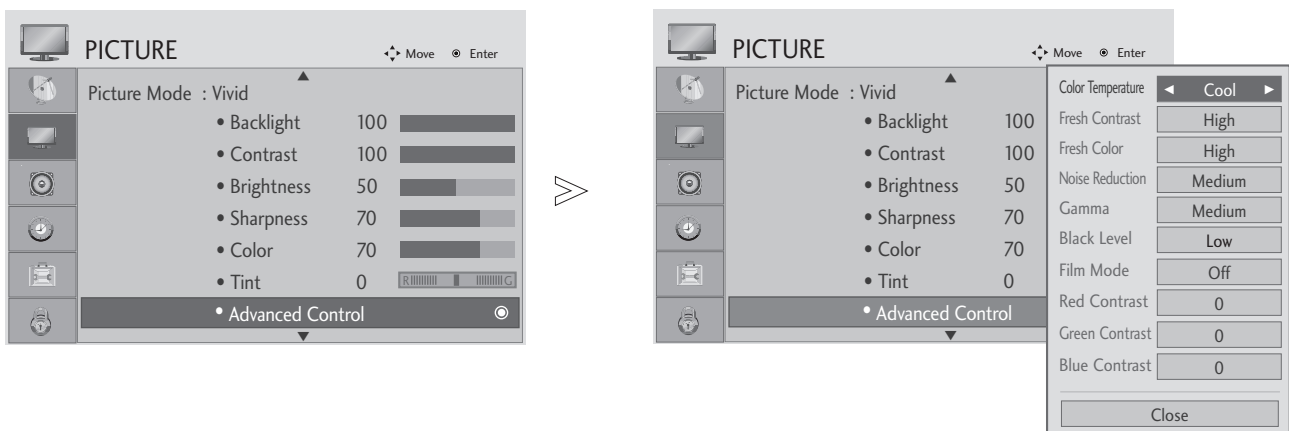

- Press the MENU button to close the menu window.
- Press the RETURN button to move to the previous menu screen.

PICTURE CONTROL

Auto Color Tone Control (Warm/Medium/Cool)

Choose one of three automatic color adjustments. Set to warm to enhance warm colors such as red, or set to cool to see less intense colors with more blue.



-   Select PICTURE.
-   Select Advanced Control.
-   Select Color Temperature.
-  Select either Cool, Medium or Warm.





- Press the MENU button to close the menu window.
- Press the RETURN button to move to the previous menu screen.

PICTURE CONTROL

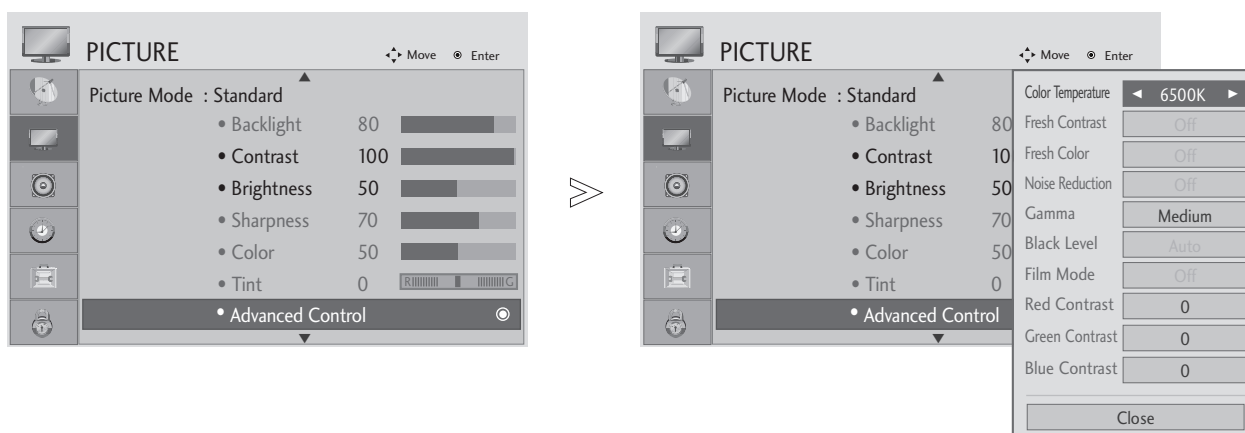
Auto Color Tone Control (6500K/9300K/sRGB)(RGB,DVI mode only)

Choose one of two automatic color adjustments.

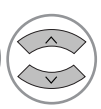

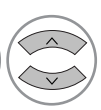
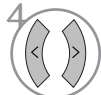
-   Select PICTURE.
-   Select Advanced Control.
-   Select Color Temperature.
-  Select either 6500K, 9300K, sRGB.

- Press the MENU button to close the menu window.
- Press the RETURN button to move to the previous menu screen.

PICTURE CONTROL

MANUAL PICTURE ADJUSTMENT

Picture Mode-User option

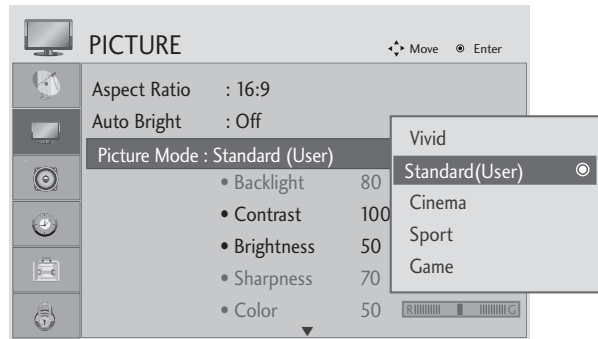
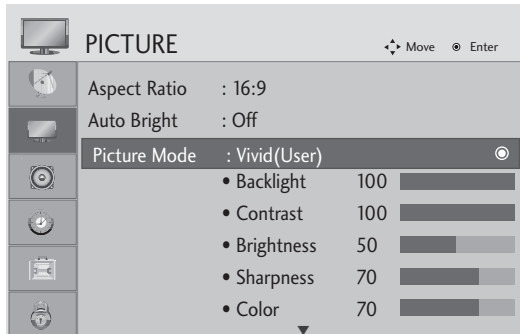

<RGB,DVI Mode>

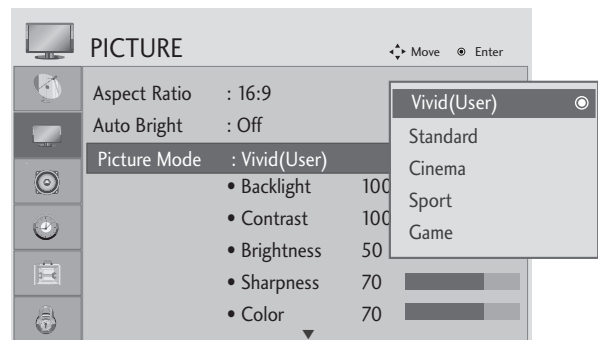

<Other mode>

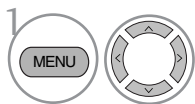

Select PICTURE.

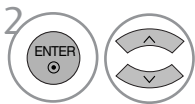

Select Picture Mode.

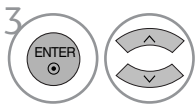

Select desired picture value.

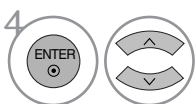

Select Backlight, Contrast, Brightness, Sharpness, Color or Tint.

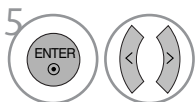

Make appropriate adjustments.

- Press the MENU button to close the menu window.
- Press the RETURN button to move to the previous menu screen.

NOTE

- ▶ You cannot adjust color, sharpness and tint in the RGB, DVI mode.

PICTURE CONTROL

PICTURE IMPROVEMENT TECHNOLOGY

Fresh Contrast

Optimizes the contrast automatically according to the brightness of the reflection.

Fresh Color

Adjusts the color of the reflection automatically to reproduce natural colors as close as possible.

Noise Reduction

Removes interference up to the point where it does not damage the original picture.

Gamma

High gamma values display whitish images and low gamma values display high contrast images.

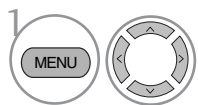
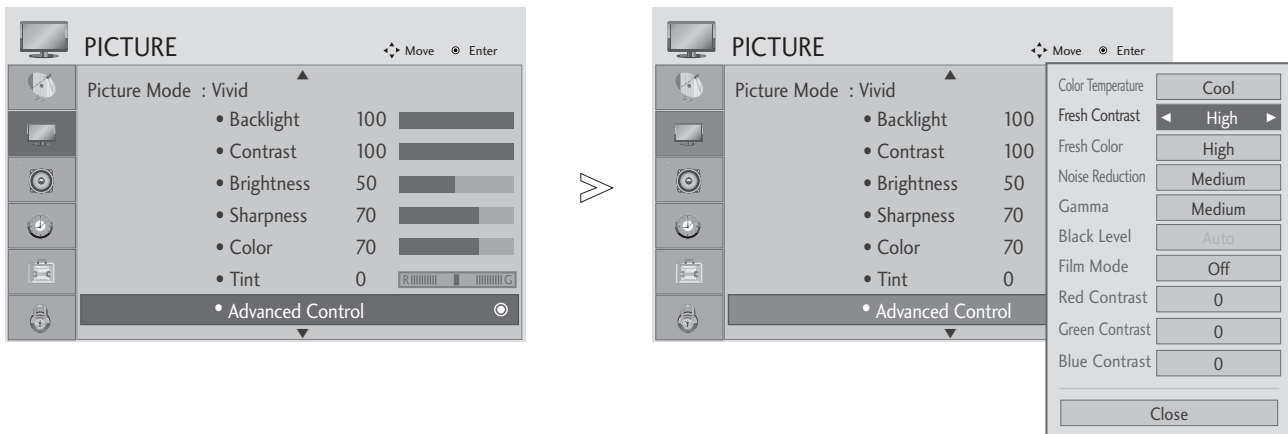

Select PICTURE.

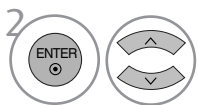

Select Advanced Control.

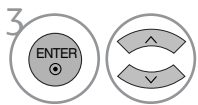

Select Fresh Contrast, Fresh Color, Noise Reduction or Gamma.

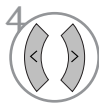

Select your desired Source.

- Press the MENU button to close the menu window.
- Press the RETURN button to move to the previous menu screen.

PICTURE CONTROL

ADVANCED - BLACK (DARKNESS) LEVEL

When you view a film, this function adjusts the set to the best picture quality.

This function works in the following mode: ATV, AV(NTSC-M), Component, HDMI

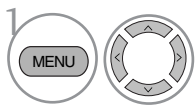
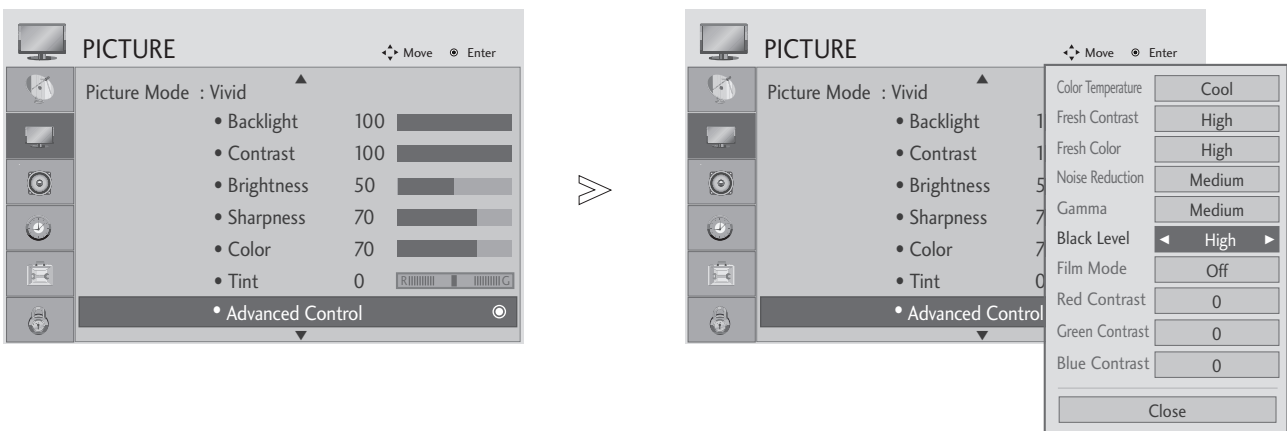

Select PICTURE.

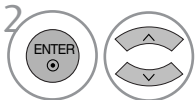

Select Advanced Control.

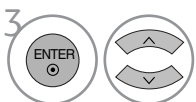

Select Black Level.

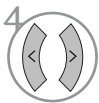

Select Low or High.

- **Low:** The reflection of the screen gets darker.
- **High:** The reflection of the screen gets brighter.

- Press the MENU button to close the menu window.
- Press the RETURN button to move to the previous menu screen.

NOTE

- ▶ If input is not ATV, AV(NTSC-M), HDMI or component, this function set to auto.
- ▶ In case of auto, user can't adjust it directly.
- ▶ Auto: Realizing the black level of the screen and set it to High or Low automatically.





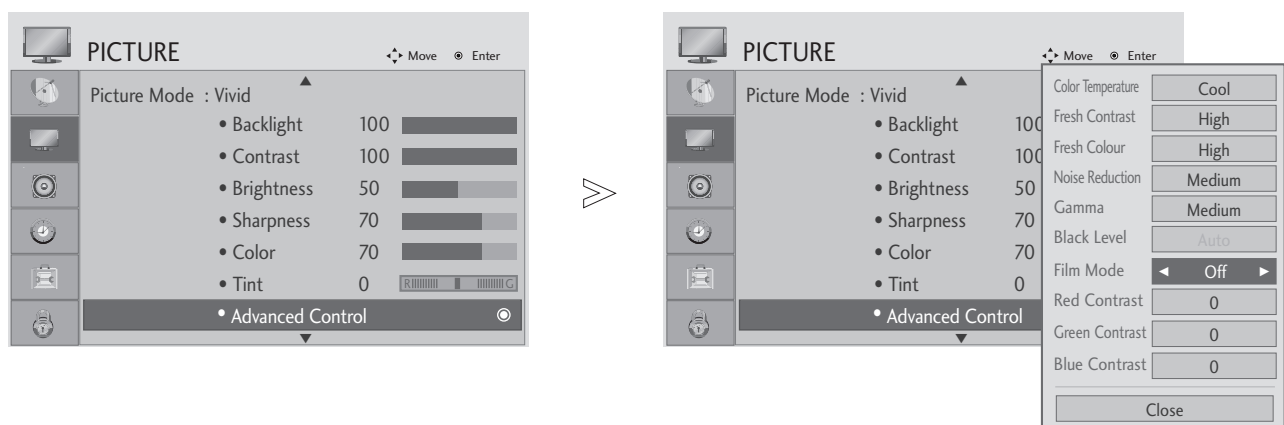

PICTURE CONTROL

ADVANCED - FILM MODE

To set the product up for the best picture quality for viewing films.

This feature operates only in TV, AV and Component 480i/1080i , HDMI 1080i mode.



-   Select PICTURE.
-   Select Advanced Control.
-   Select Film Mode.
-  Select On or Off.





- Press the MENU button to close the menu window.
- Press the RETURN button to move to the previous menu screen.

PICTURE CONTROL

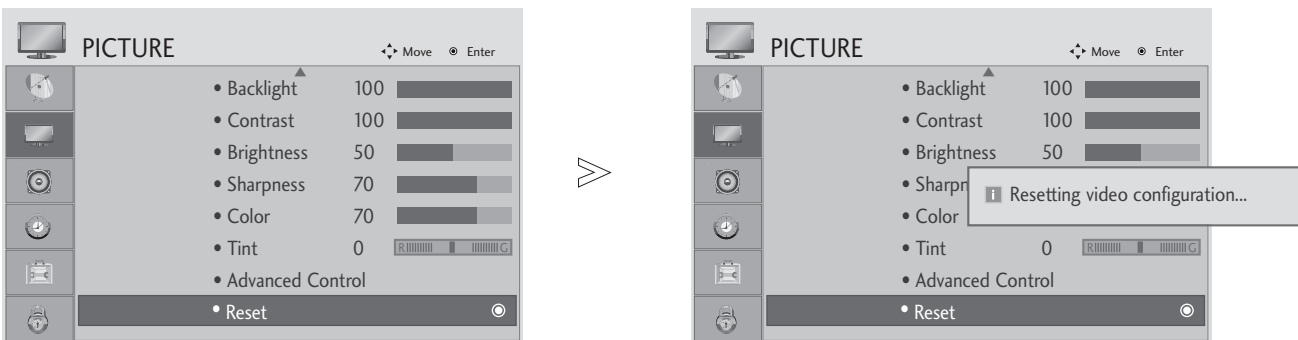
PICTURE RESET

Settings of the selected picture modes return to the default factory settings.



- 1   Select PICTURE.
- 2   Select Picture Reset.
- 3  Initialize the adjusted value.

- Press the MENU button to close the menu window.
- Press the RETURN button to move to the previous menu screen.

PICTURE CONTROL

SCREEN SETUP FOR PC MODE

Selecting Resolution

To view a normal picture, set the resolution to match what the PC is using.

This function works in the following resolution in RGB[PC] mode.

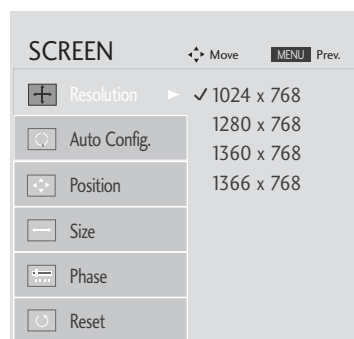
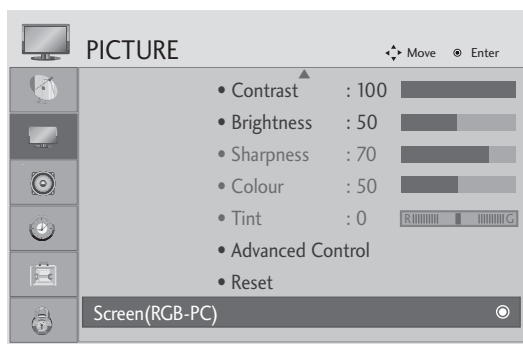

<Vertical resolution : 768>

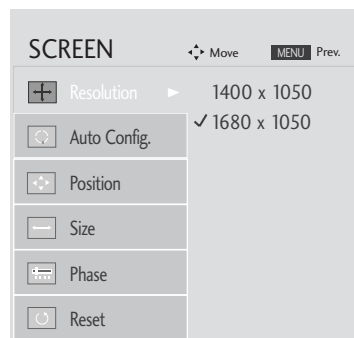

<Vertical resolution : 1050>

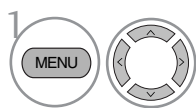

Select PICTURE.

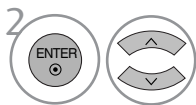

Select SCREEN(RGB-PC).

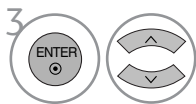

Select Resolution.

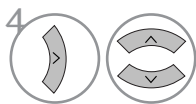

Select the desired resolution.

- Press the MENU button to close the menu window.
- Press the RETURN button to move to the previous menu screen.

PICTURE CONTROL

Auto Configure (RGB [PC] mode only)

Automatically adjusts picture position and minimizes image instability. After adjustment, if the image is still not correct, your set is functioning properly but needs further adjustment.

Auto configure

This function is for automatic adjustment of the screen position, clock, and phase. The displayed image will be unstable for a few seconds while the auto configuration is in progress.

1. Using OSD

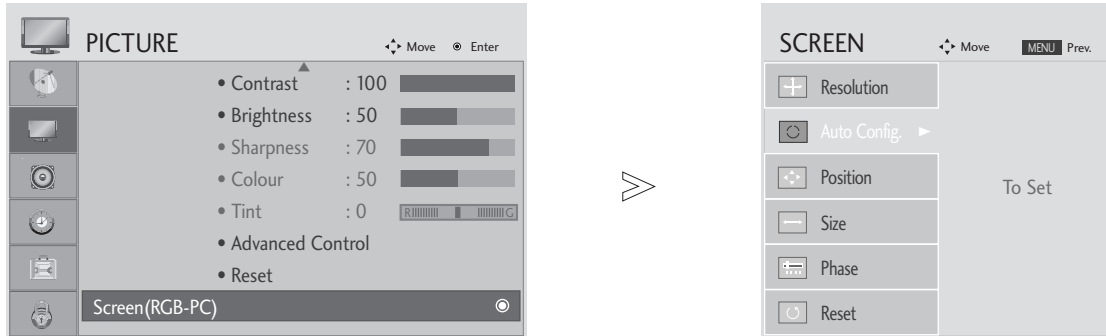

1. Select PICTURE.
2. Select SCREEN(RGB-PC).
3. Select Auto Config.
4. Select Yes.

5. Run Auto Config.

- If the position of the image is still not correct, try Auto adjustment again.
- If picture needs to be adjusted again after Auto adjustment in RGB (PC), you can adjust the **Position, Size or Phase**.

2. Using ENTER(Remocon or control key)

This function is available for RGB signals only.

1. Press ENTER.

- If you don't want Auto Configure, do not press ENTER(●).

2. Press ENTER.

- Auto in Progress
For optimal display
change resolution to 1920 x 1080
<Others Resolution>

- Press the MENU button to close the menu window.
- Press the RETURN button to move to the previous menu screen.







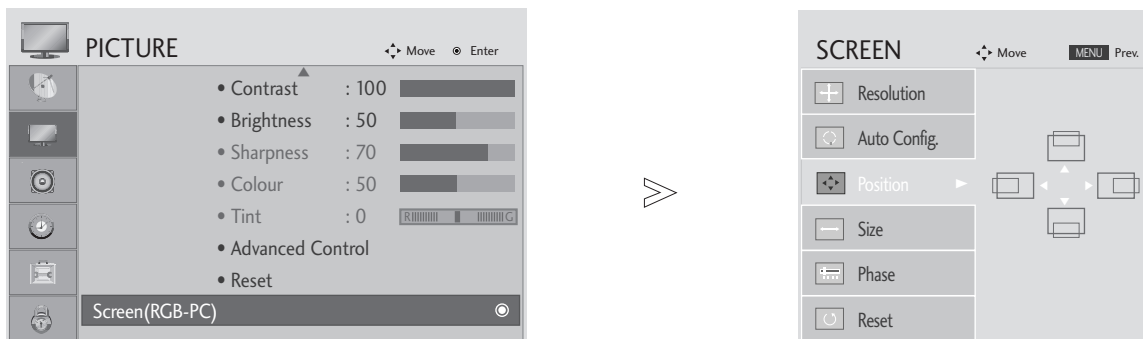

PICTURE CONTROL

Adjustment for screen Position, Size, Phase

If the picture is not clear after auto adjustment and especially if characters are still shaky, adjust the picture phase manually.

This function works in the following mode: RGB[PC].



-   Select PICTURE.
-   Select SCREEN(RGB-PC).
-   Select Position, Size or Phase.
-    Make appropriate adjustments.

- Press the MENU button to close the menu window.
- Press the RETURN button to move to the previous menu screen.







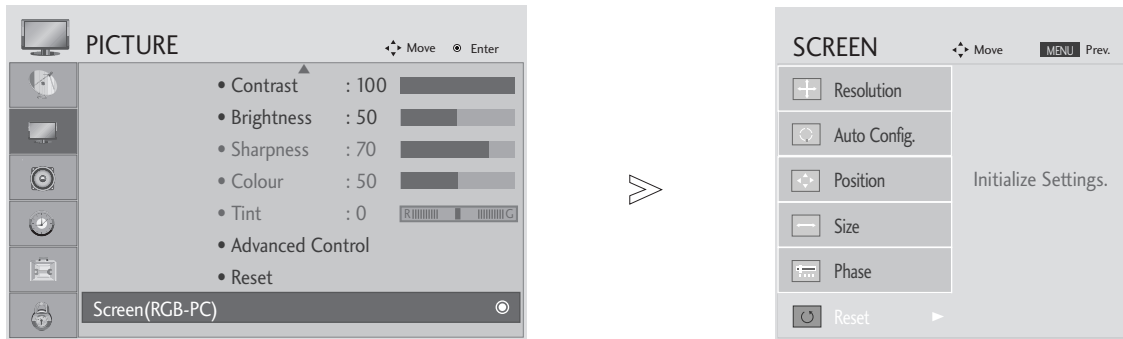

PICTURE CONTROL

Screen Reset

Returns Position, Size and Phase to the default factory settings.

This function works in the following mode: RGB[PC].



- 1   Select PICTURE.
- 2   Select SCREEN(RGB-PC).
- 3   Select Reset.
- 4   Select Yes.
- 5  Run Reset.





- Press the MENU button to close the menu window.
- Press the RETURN button to move to the previous menu screen.

SOUND CONTROL

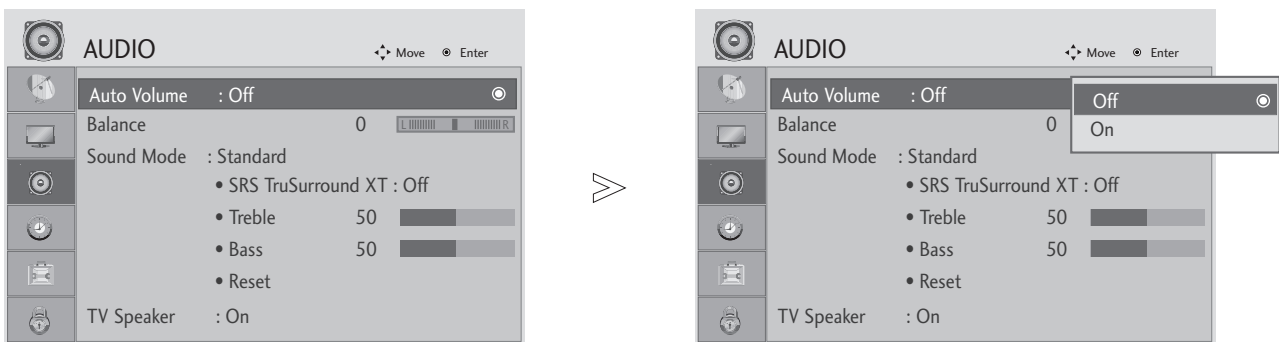
AUTO VOLUME LEVELER

AVL automatically remains on the same volume level if you change programmes.

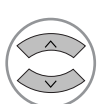

-   Select AUDIO.
-   Select Auto Volume.
-   Select On or Off.

- Press the MENU button to close the menu window.
- Press the RETURN button to move to the previous menu screen.

SOUND CONTROL

BALANCE

You can adjust the sound balance of the speakers to preferred levels.

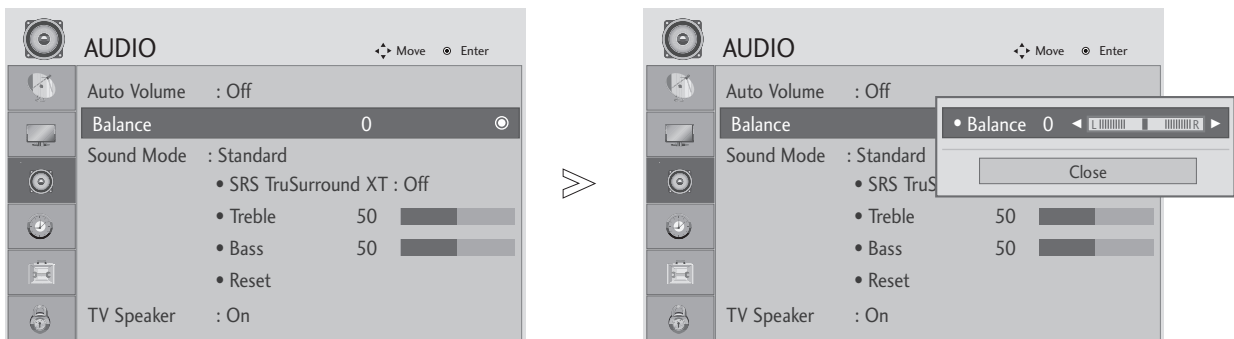

-   Select AUDIO.
-   Select Balance.
-   Make desired adjustment.

- Press the MENU button to close the menu window.
- Press the RETURN button to move to the previous menu screen.

SOUND CONTROL

PRESET SOUND SETTINGS - SOUND MODE

Sound Mode lets you enjoy the best sound without any special adjustment as the TV sets the appropriate sound options based on the program content.

Standard, Music, Cinema, Sport, and **Game** are preset for optimum sound quality at the factory and are not adjustable.

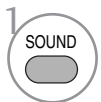
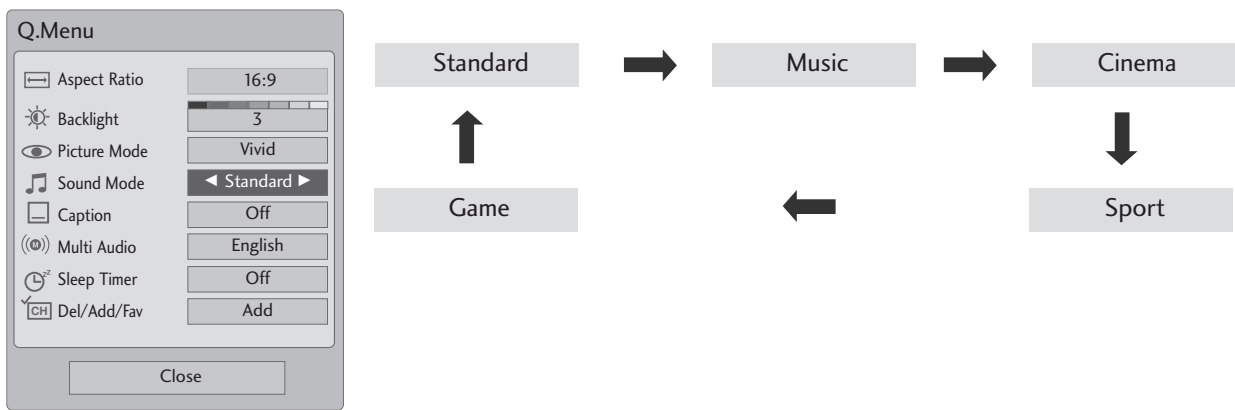

Select **Standard, Music, Cinema, Sport,** or **Game.**

- Press the RETURN button to move to the previous menu screen.

SOUND CONTROL

PRESET SOUND SETTINGS - SOUND MODE

You can select your preferred sound setting; Standard, Music, Cinema, Sport and Game and you can also adjust the frequencies of the equalizer.

Standard, Music, Cinema, Sport and Game are preset for optimum sound quality at the factory.

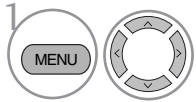
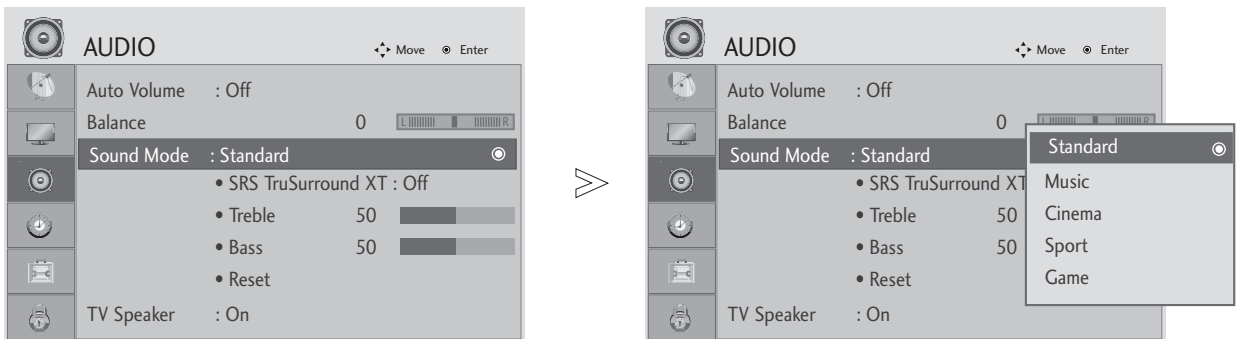

Select AUDIO.

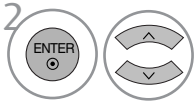

Select Sound Mode.

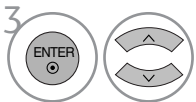

Select Standard, Music, Cinema, Sport or Game.

- Press the MENU button to close the menu window.
- Press the RETURN button to move to the previous menu screen.









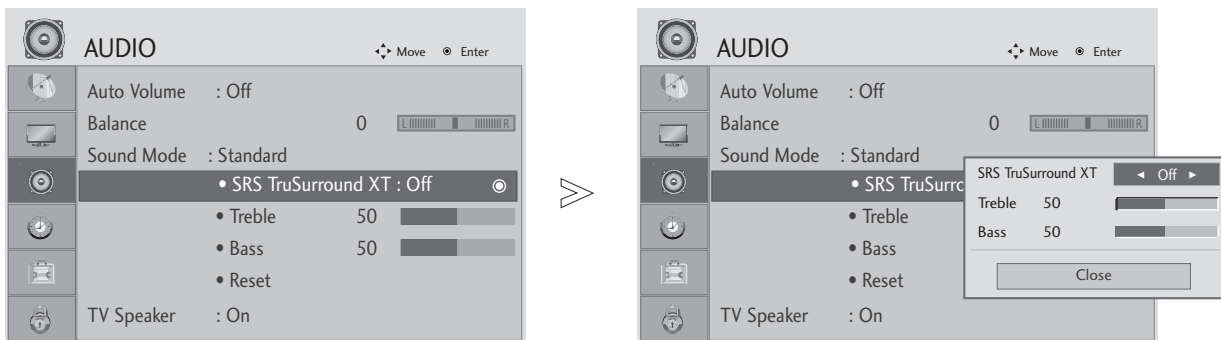

▶ are a trademark of SRS Labs, Inc.
▶ TruSurround XT technology is incorporated under license from SRS Labs, Inc.

SOUND CONTROL

SOUND SETTING ADJUSTMENT - USER MODE

Adjusting the audio equalizer.



-   Select AUDIO.
-   Select Sound Mode.
-   Select Standard, Music, Cinema, Sport or Game.
-   Select SRS TruSurround XT or Treble or Bass.
-   Set the desired sound level.





- Press the MENU button to close the menu window.
- Press the RETURN button to move to the previous menu screen.

SOUND CONTROL

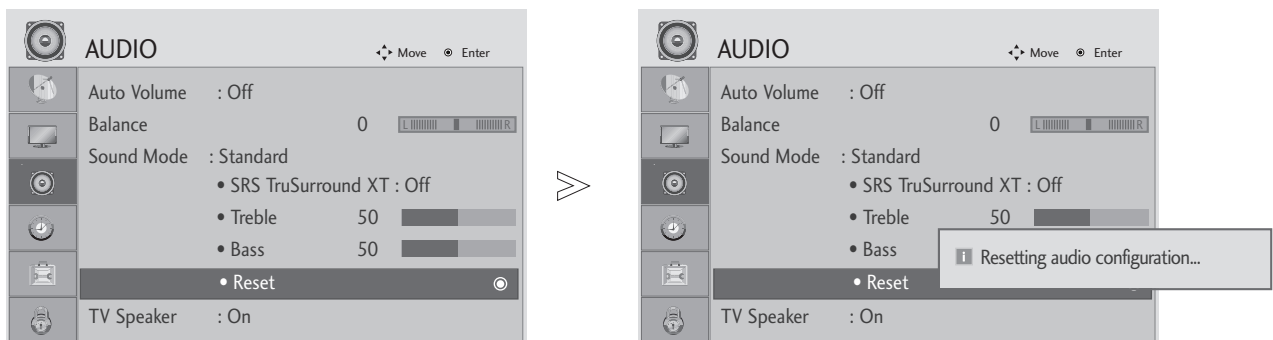
AUDIO RESET

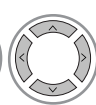
Settings of the selected Sound Mode return to the default factory settings.

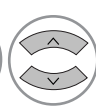

- 1   Select AUDIO.
- 2   Select Reset.
- 3  Initialize the adjusted value.





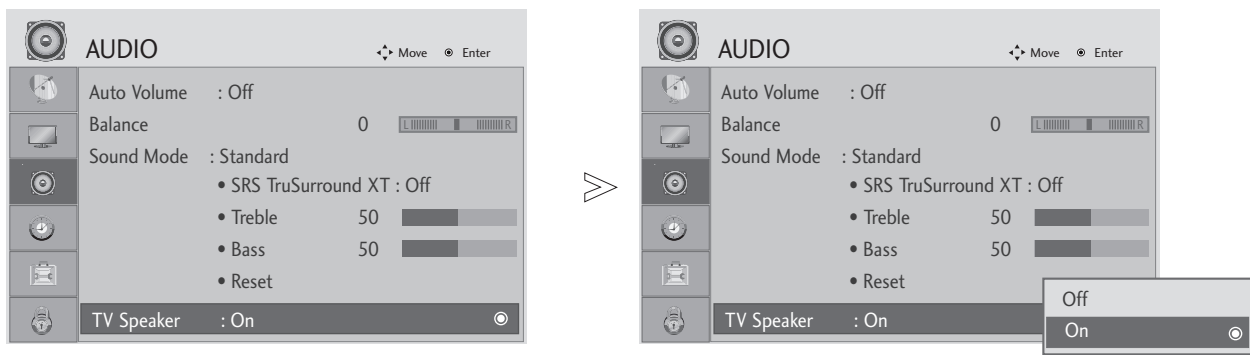

- Press the MENU button to close the menu window.
- Press the RETURN button to move to the previous menu screen.

SOUND CONTROL

TV SPEAKERS ON/ OFF SETUP

You can turn off the speakers when using external audio system.



-   Select AUDIO.
-   Select TV Speaker.
-   Select On or Off.

- Press the MENU button to close the menu window.
- Press the RETURN button to move to the previous menu screen.

SOUND CONTROL

STEREO/SAP BROADCAST SETUP

For Analog only: This TV can receive MTS stereo programs and any SAP (Secondary Audio Program) that accompanies the stereo program if the station transmits an additional sound signal. Mono sound is automatically used if the broadcast is only in Mono.

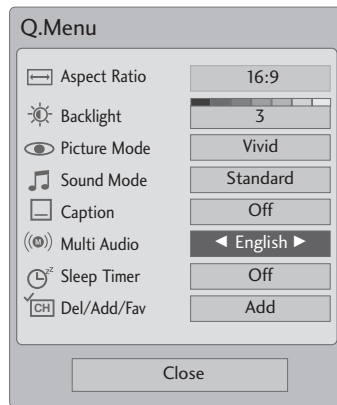

Analog Mode

1   Select **SAP**.

2  Select **Mono, Stereo, or SAP**.

Digital Mode

1   Select **Multi Audio**.

2  Select other languages.

- Press the RETURN button to move to the previous menu screen.

TIME SETTING

CLOCK SETTING

Auto Clock Setup

The time is set automatically from a digital channel signal.

The digital channel signal includes information for the current time provided by the broadcasting station.

Set the clock manually if the current time is set incorrectly by the auto clock function.

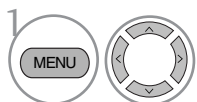
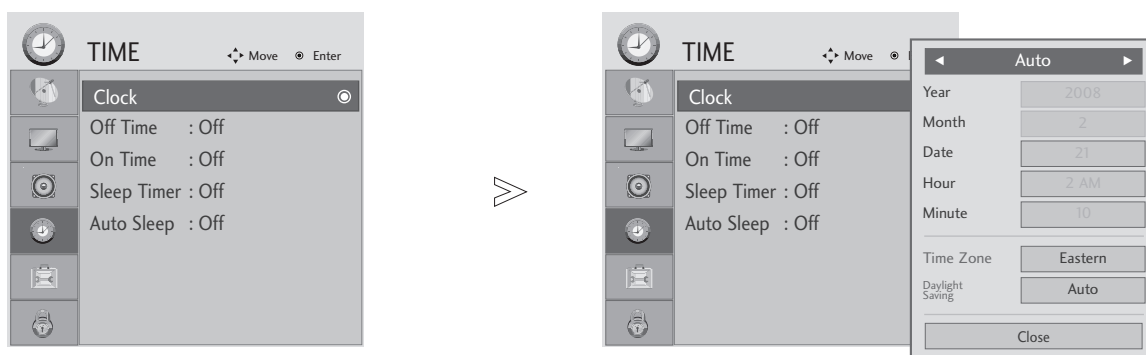

Select **TIME**.

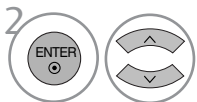

Select **Clock**.

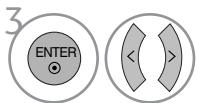

Select **Auto**.

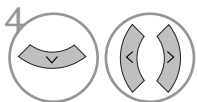

Select your viewing area time zone.

• U.S.A: **Eastern, Central, Mountain, Pacific, Alaska, or Hawaii.**

• Canada: **Eastern, Central, Mountain, Pacific, New F.land, or Atlantic.**

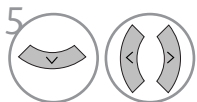

Select **Auto, Off, or On** (depending on whether or not your viewing area observes Daylight Saving time).





- Press the MENU button to close the menu window.
- Press the RETURN button to move to the previous menu screen.

TIME SETTING

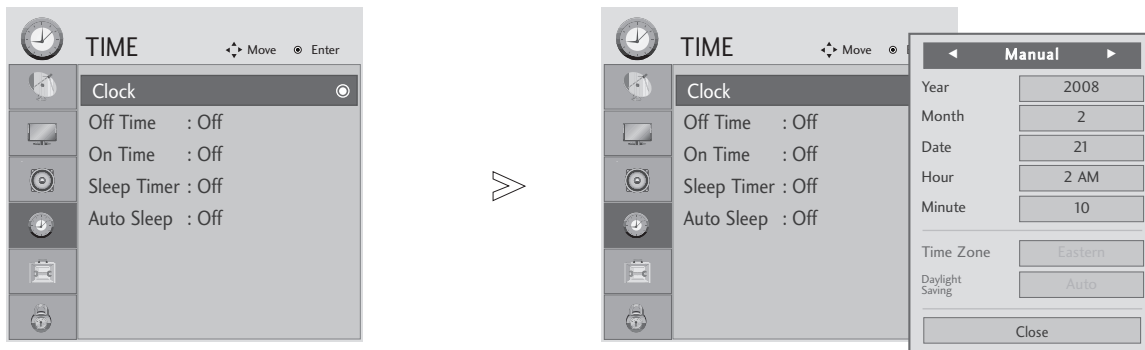
Manual Clock Setup

If the current time setting is wrong, reset the clock manually.



-   Select **TIME**.
-   Select **Clock**.
-   Select **Auto**.
-  Select the Year, Month, Date, Hour, or Minutes option.
-  Set the Year, Month, Date, Hour, or Minutes option.

- Press the MENU button to close the menu window.
- Press the RETURN button to move to the previous menu screen.

TIME SETTING

AUTO ON/OFF TIMER SETTING



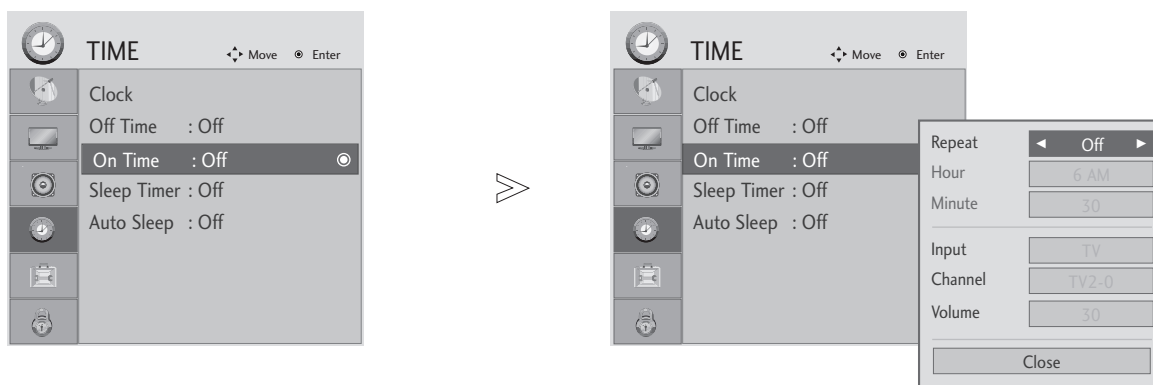

The Off time function automatically switches the set to standby at a preset time. Two hours after the set is switched on by the on time function it will automatically switch back to standby mode unless a button has been pressed.

The Off time function overrides the On timer function if both are set to the same time. The set must be in standby mode for the On timer to work.

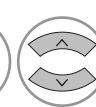
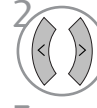

-   Select TIME.
-   Select Off time or On time.
-   Select Repeat.
-   Select Off, Once, Everyday, Mon ~ Fri, Mon ~ Sat, Weekend or Sunday.
-   Set the hour or minutes.

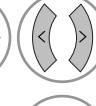
- To cancel On/Off Time function, select Off.
- For On Time function only

-   Select Input.
-   Select **DVI, TV, AV, Component, RGB-PC, or HDMI1 - 2.**
-   Set the programme.
-   Adjust volume level at switch-on.





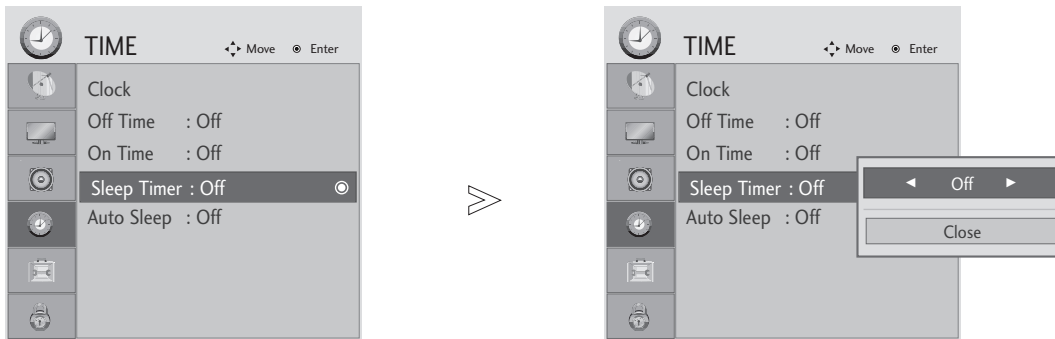

- Press the MENU button to close the menu window.
- Press the RETURN button to move to the previous menu screen.

TIME SETTING

SLEEP TIMER SETTING

The sleep timer automatically switches the set off after the preset time has elapsed.



-   Select **TIME**.
-   Select **Sleep Timer**.
-   Select **Off, 10, 20, 30, 60, 90, 120, 180 or 240 Min.**
-  Confirm it.

- Press the MENU button to close the menu window.
- Press the RETURN button to move to the previous menu screen.





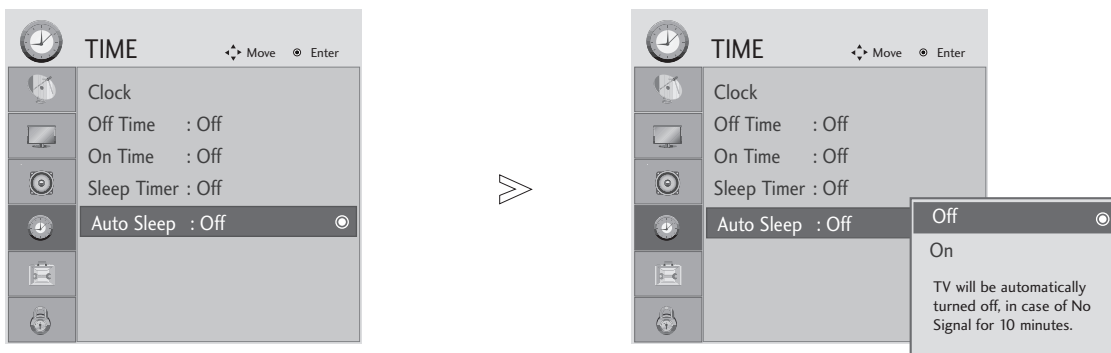

- When you switch the set off, the preset sleep time is cancelled.
- You can also adjust Sleep Timer in the Q.Menu.

TIME SETTING

AUTO SHUT-OFF SETTING

If the set is switched on and there is no input signal, it will switch off automatically after 10 minutes.



- 1   Select TIME.
- 2   Select Auto Sleep.
- 3   Select Off or On.

- Press the MENU button to close the menu window.
- Press the RETURN button to move to the previous menu screen.

OPTION SETTING

ON-SCREEN MENUS LANGUAGE SELECTION

The menus can be shown on the screen in the selected language.

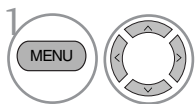
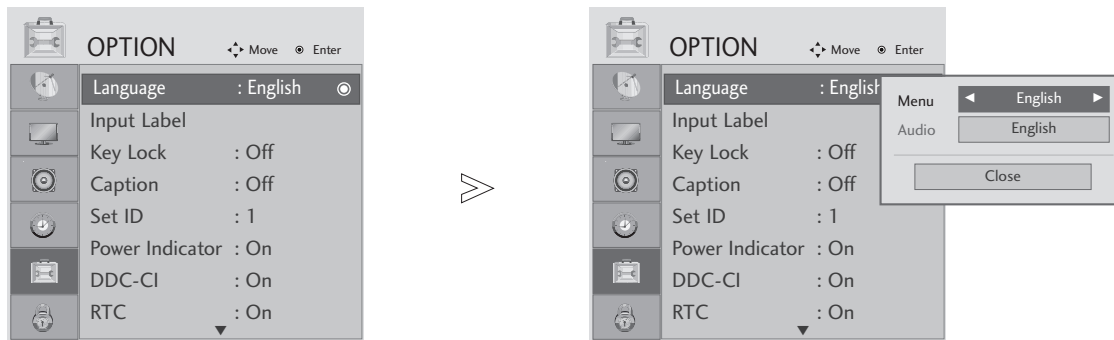

Select OPTION.

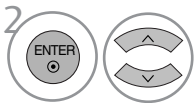

Select Language.

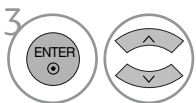

Select Menu.



Select your desired language.

From this point on, the on-screen menus will be shown in the selected language.







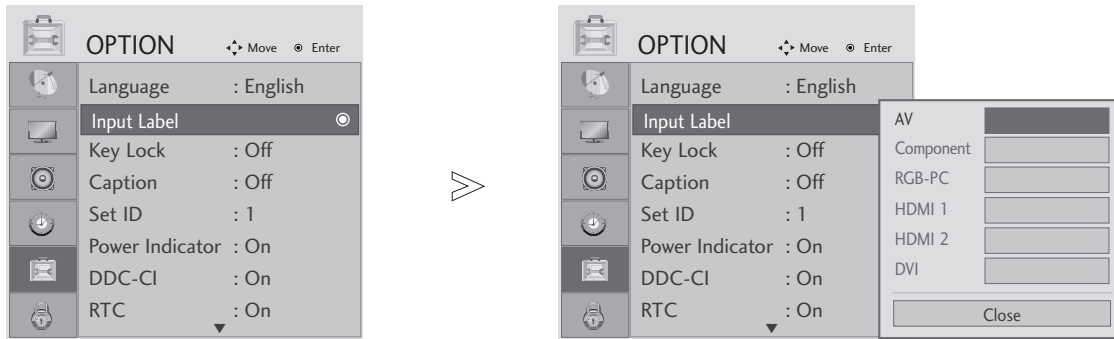

- Press the MENU button to close the menu window.
- Press the RETURN button to move to the previous menu screen.

OPTION SETTING

INPUT LABEL

Selects a label for each input source.



- 1   Select OPTION.
- 2    Select Input Label.
- 3   Select the source.
- 4  Select the label.





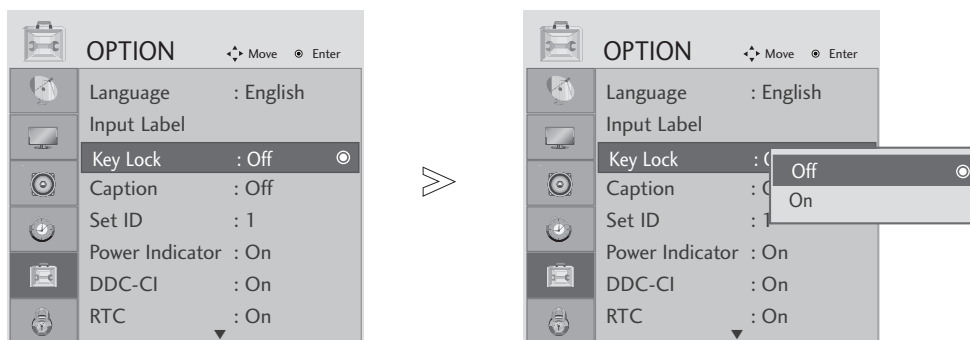

- Press the MENU button to close the menu window.
- Press the RETURN button to move to the previous menu screen.

OPTION SETTING

KEY LOCK

The set can be configured so that the remote control is required to control it. This feature can be used to prevent unauthorized viewing.



- 1   Select OPTION.
- 2   Select Key Lock.
- 3   Select On or Off.
- 4  Save.

- In Key Lock 'On', if the set is turned off, press the  / I, INPUT, CH ▲ ▼ button on the TV or POWER, INPUT, CH + - or NUMBER buttons on the remote control.
- With the Key Lock On, the display ' Key Lock' appears on the screen if any button on the front panel is pressed while viewing the TV.







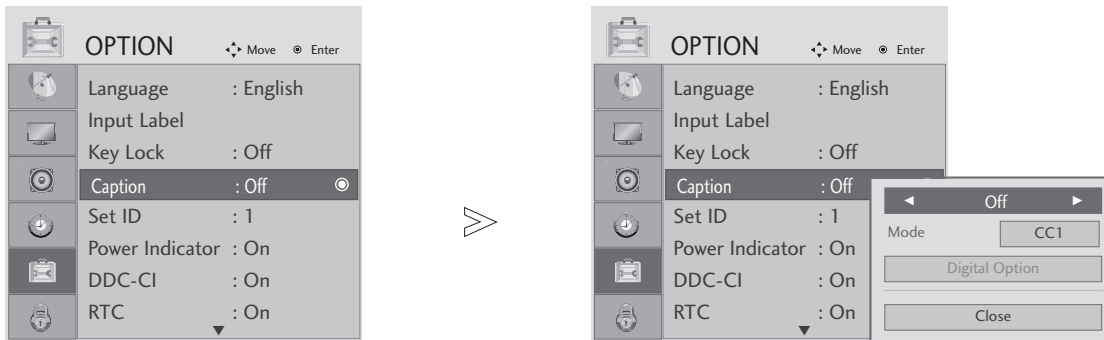

- Press the MENU button to close the menu window.
- Press the RETURN button to move to the previous menu screen.

OPTION SETTING

Analog Broadcasting System Captions

Caption must be provided to help people with hearing loss watch TV. Select a caption mode for displaying captioning information if provided on a program. Analog caption displays information at any position on the screen and is usually the program's dialog. Caption/Text, if provided by the broadcaster, would be available for both digital and analog channels on the Antenna/Cable. This TV is programmed to memorize the caption/text mode which was last set when you turned the power off. This function is only available when **Caption Mode** is set **On**.



- 1   Select **OPTION**.
- 2   Select **Caption**
- 3   Select **On**.
- 4   Select **CC1-4** or **Text1-4**.

■ CAPTION

The term for the words that scroll across the bottom of the TV screen; usually the audio portion of the program provided for the hearing impaired.

■ TEXT

The term for the words that appear in a large black frame and almost cover the entire screen; usually messages provided by the broadcaster.

- Press the MENU button to close the menu window.
- Press the RETURN button to move to the previous menu screen.

OPTION SETTING







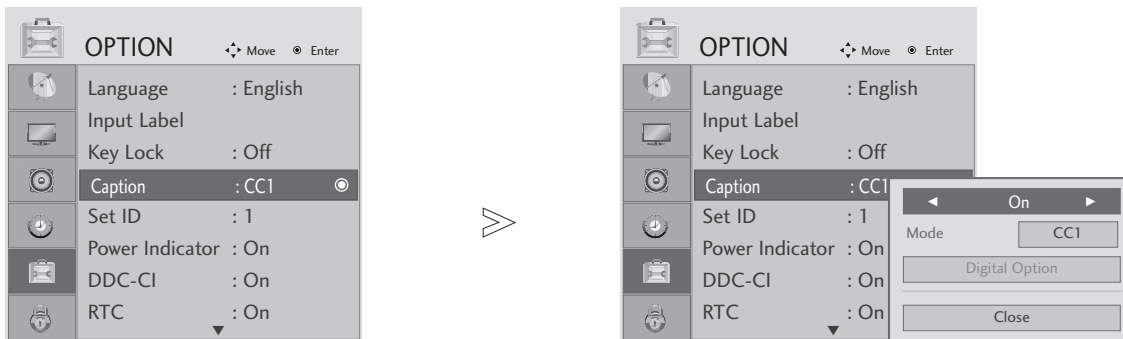

Digital Broadcasting System Captions

Choose the language you want the DTV/CADTV Captions to appear in.

Other Languages can be chosen for digital sources only if they are included on the program.

This function is only available when Caption Mode is set On.



- 1   Select **OPTION**.
- 2   Select **Caption**
- 3   Select **On**.
- 4   Select **CC1-4** or **Text1-4** or **Service1-6**.

- Press the MENU button to close the menu window.
- Press the RETURN button to move to the previous menu screen.

OPTION SETTING

Caption Option

Customize the DTV/CADTV captions that appear on your screen.

This function is only available when Caption Mode is set On.

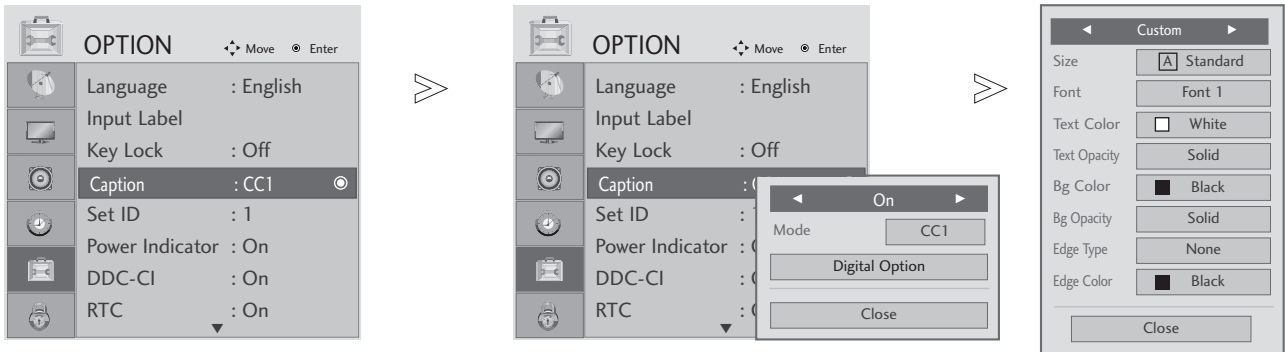



1   Select **OPTION**.

2   Select **Caption**

3   Select **On**.

4   Select **Digital Option**.

5   Select **Custom**.

6   Customize the **Style, Font**, etc., to your preference. A preview icon is provided at the bottom of the screen, use it to see the caption language.

- **Size:** Set the word size.
- **Font:** Select a typeface for the text.
- **Text Color:** Choose a color for the text.
- **Text Opacity:** Specify the opacity for the text color.
- **Bg (Background) Color:** Select a background color.
- **Bg (Background) Opacity:** Select the opacity for the background color.
- **Edge Type:** Select an edge type.
- **Edge Color:** Select a color for the edges.





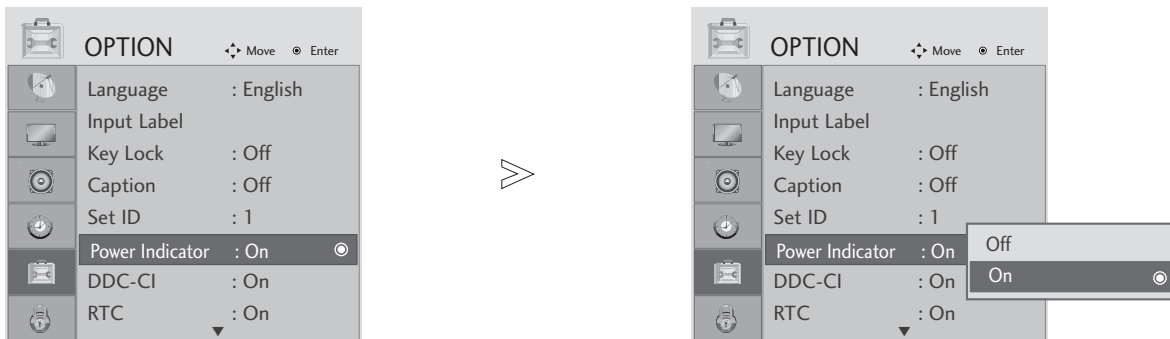

- Press the MENU button to close the menu window.
- Press the RETURN button to move to the previous menu screen.

OPTION SETTING

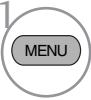
POWER INDICATOR

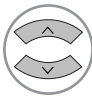
It helps you control LED when power is turned on.



-   Select OPTION.
-   Select Power Indicator.
-   Select On or Off.
- 

- Press the MENU button to close the menu window.
- Press the RETURN button to move to the previous menu screen.

OPTION SETTING





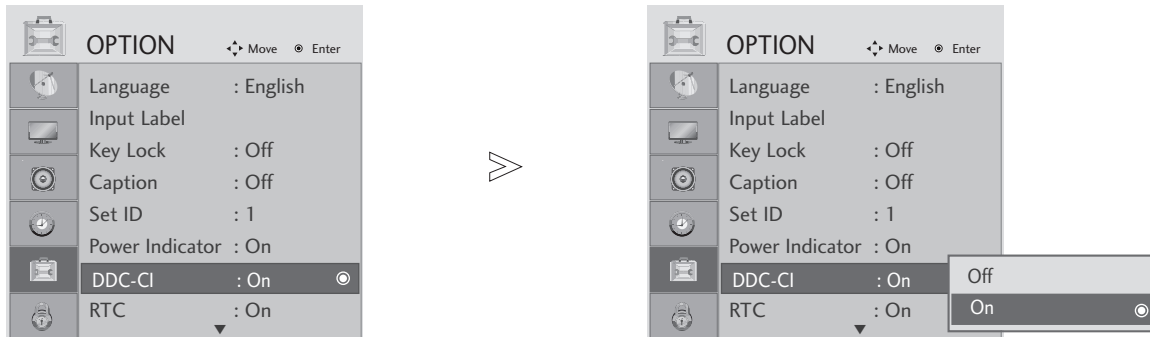

DDC CI(Only RGB, DVI mode)

DDC/CI (Display Data Channel Command Interface) is a communication protocol for communications between a PC and Monitor.

DDC/CI makes it possible to adjust and setup detailed functions on the PC instead of the Monitor.

On allows adjustments on the PC. Off ignores the communications of DDC/CI data.



- 1   Select OPTION.
- 2   Select DDC CI.
- 3   Select On or Off.
- 4 





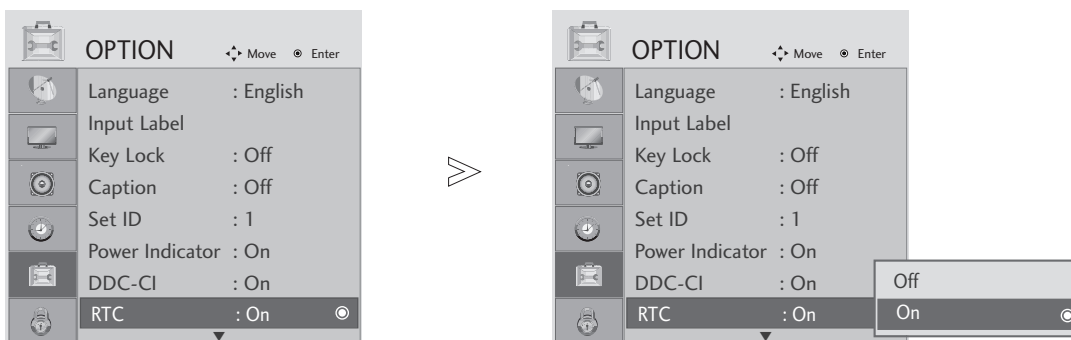

- Press the MENU button to close the menu window.
- Press the RETURN button to move to the previous menu screen.

OPTION SETTING

RTC(Only M2762D)

If you set ON, you enable the response time control function.
If you set OFF, you disenable the response time control function.



- 1   Select OPTION.
- 2   Select RTC.
- 3   Select On or Off.
- 4 

- Press the MENU button to close the menu window.
- Press the RETURN button to move to the previous menu screen.

PARENTAL CONTROL / RATINGS

LOCK SYSTEM

Enter the password, press '0', '0', '0', '0' on the remote control handset.

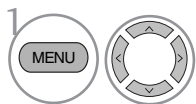
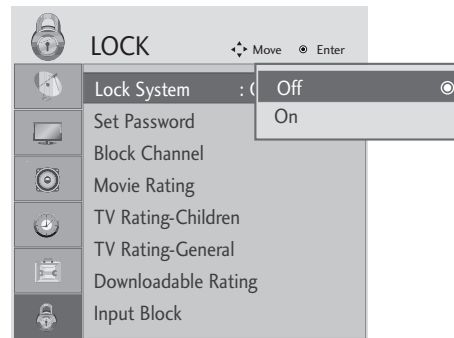

Select LOCK.

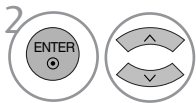

Select Lock System.

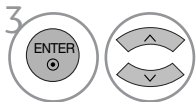

Select On or Off.

- When you select On, the Lock System is enable.

- Press the MENU button to close the menu window.
- Press the RETURN button to move to the previous menu screen.

PARENTAL CONTROL / RATINGS

SET PASSWORD

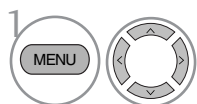
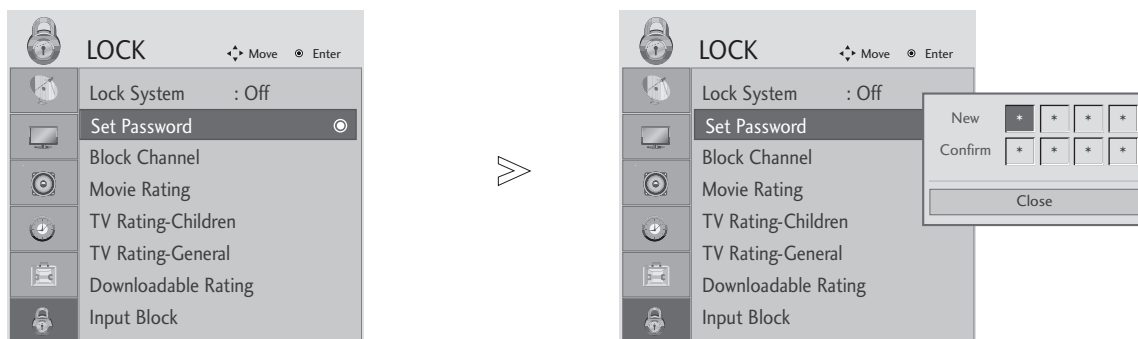

Select LOCK.

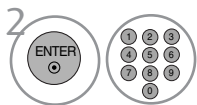

Input the password.



Select **Set password**.

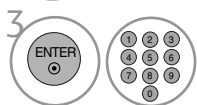

Choose any 4 digits for your new password.
As soon as the 4 digits are entered, re-enter the same 4 digits on the **Confirm**.

• If you forget your password, press '7', '7', '7', '7' on the remote control handset.

- Press the MENU button to close the menu window.
- Press the RETURN button to move to the previous menu screen.





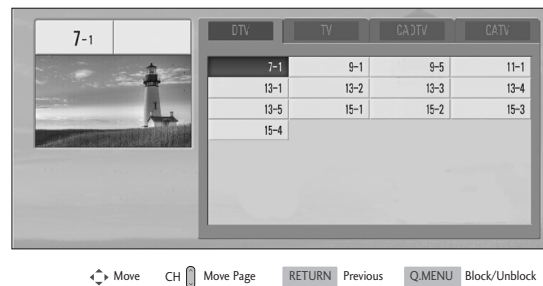

PARENTAL CONTROL / RATINGS

BLOCK CHANNEL

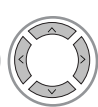
Blocks any programs that you do not want to watch or that you do not want your children to watch.

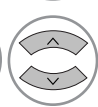
This function is available in Lock System "On".

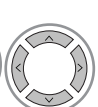

-   Select LOCK.
-   Select Block Channel.
-   Select a channel to block or unblock it.
-  Block or unblock a channel.





- Press the MENU button to close the menu window.
- Press the RETURN button to move to the previous menu screen.

PARENTAL CONTROL / RATINGS

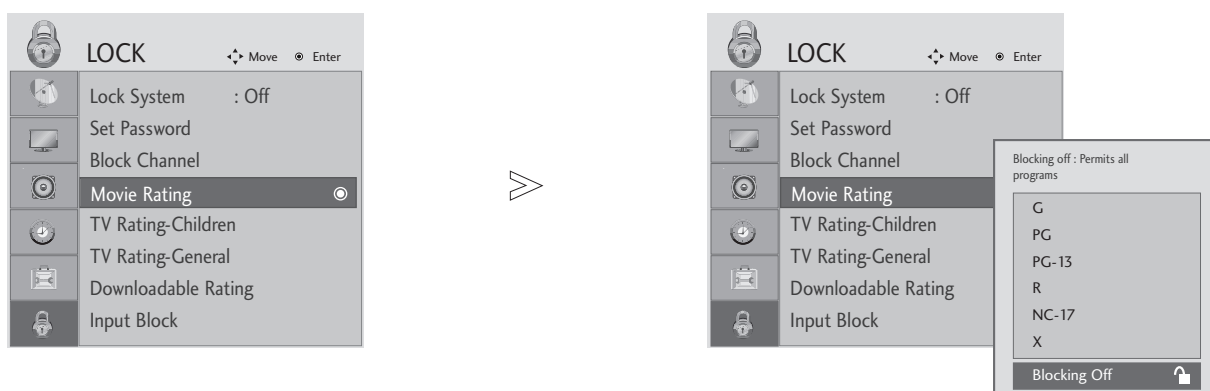
MOVIE RATING

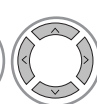
Blocks movies according to the movie ratings limits specified, so children cannot view certain movies. You can set the ratings limit by blocking out all the movies with the ratings above a specified level. Keep in mind that the movie ratings limit only applies to movies shown on TV, not TV programs, such as soap operas.



- 1   Select **LOCK**.
- 2   Select **Movie Rating**.
- 3  Select **G, PG, PG-13, R, NC-17** or **X**.

- G (General audience)
- PG (Parental guidance suggested)
- PG-13 (Parents strongly cautioned)
- R (Restricted)
- NC-17 (No one 17 and under admitted)
- X (Adult only)
- Blocking Off (Permits all programs)
- ▶ If you set PG-13: G and PG movies will be available, PG-13, R, NC-17 and X will be blocked.





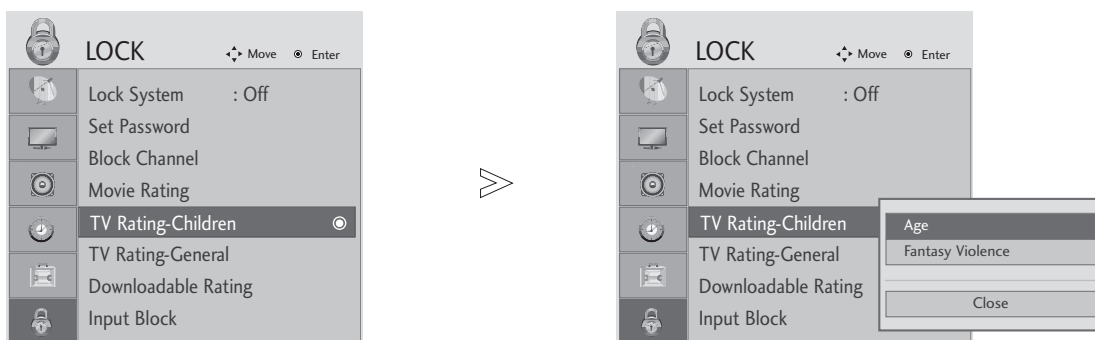

- Press the MENU button to close the menu window.
- Press the RETURN button to move to the previous menu screen.

PARENTAL CONTROL / RATINGS

TV RATING-CHILDREN

Prevents children from watching certain children's TV programs, according to the ratings limit set. The children rating does not apply to other TV programs. Unless you block certain TV programs intended for mature audiences in the TV Rating - sub menu, your children can view those programs.



- 1   Select **LOCK**.
- 2   Select **TV Rating-Children**.
- 3  Select **Age** or **Fantasy Violence**.
- 4  Select block options.

- Age (applies to TV-Y, TV-Y7)
- Fantasy Violence (applies to TV-Y7)





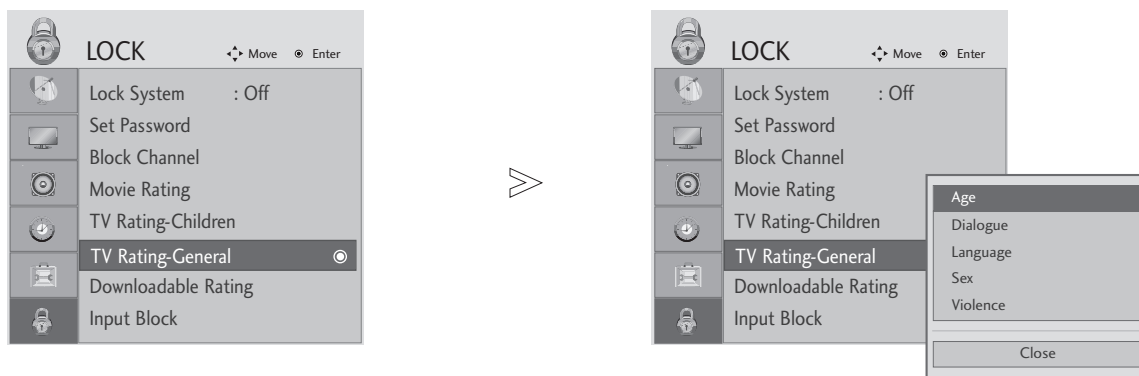

- Press the MENU button to close the menu window.
- Press the RETURN button to move to the previous menu screen.

PARENTAL CONTROL / RATINGS

TV RATING-GENERAL

Based on the ratings, blocks certain TV programs that you and your family do not want to view.



- 1   Select LOCK.
- 2   Select **TV Rating-General**.
- 3  Select **Age, Dialogue, Language, Sex or Violence**.
- 4  Select block options.

- Age (applies to TV-G,TV-PG,TV-14,TV-MA).
- Dialogue-sexual dialogue (applies to TV-PG,TV-14).
- Language-adult language (applies to TV-PG, TV-14, TV-MA).
- Sex-sexual situations (applies to TV-PG, TV-14, TV-MA).
- Violence (applies to TV-PG, TV-14, TV-MA).





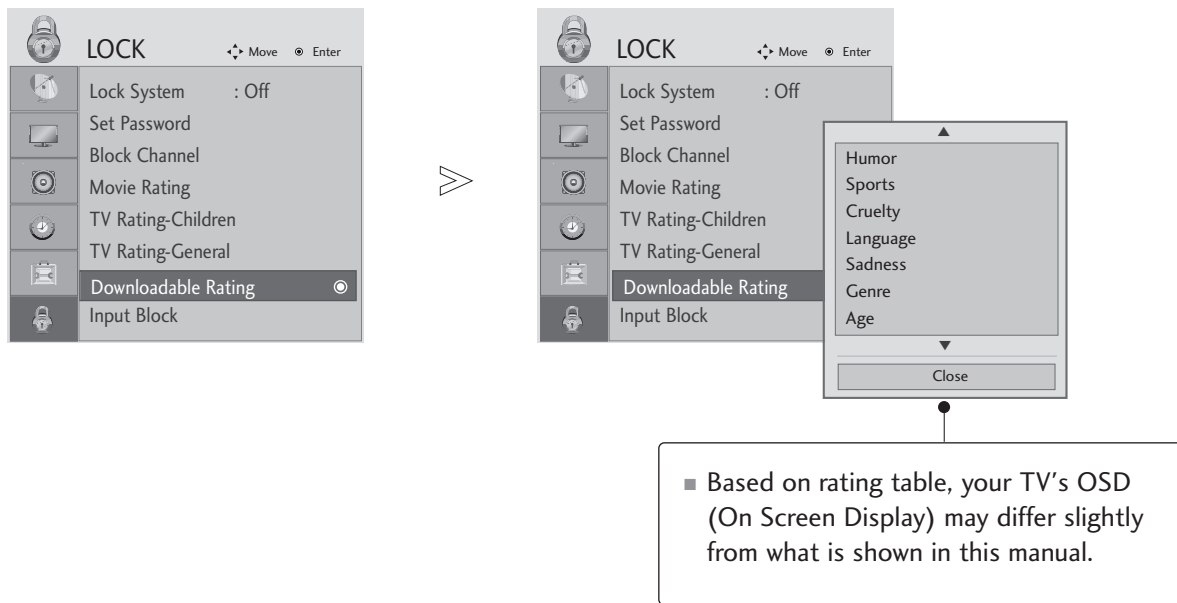

- Press the MENU button to close the menu window.
- Press the RETURN button to move to the previous menu screen.

PARENTAL CONTROL / RATINGS

DOWNLOADABLE RATING

This function may become available in the future and will be available only for digital channel signal. This function operates only when TV has received Region5 Rating data.



1.   Select **LOCK**.
2.   Select **Downloadable Rating**.
3.  Select desired **Downloadable Rating** option.
4.  Select desired option and block it.





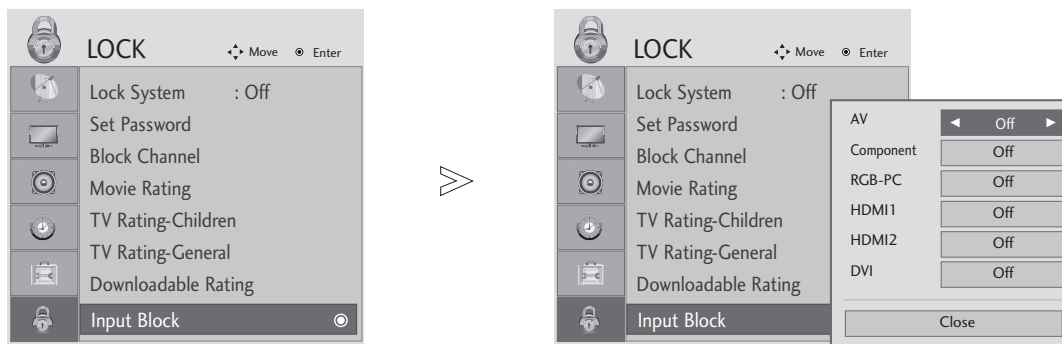

- Press the MENU button to close the menu window.
- Press the RETURN button to move to the previous menu screen.

PARENTAL CONTROL / RATINGS

INPUT BLOCK

Enables you to block an input.



- 1   Select **LOCK**.
- 2   Select **Input Block**.
- 3  Select input source.
- 4  Select **On** or **Off**.

- Press the MENU button to close the menu window.
- Press the RETURN button to move to the previous menu screen.

APPENDIX

TROUBLESHOOTING

The operation does not work normally.	
The remote control doesn't work	<ul style="list-style-type: none">■ Check to see if there is any object between the product and the remote control causing obstruction. Ensure you are pointing the remote control directly at the set.■ Ensure that the batteries are installed with correct polarity (+ to +, - to -).■ Ensure that the correct remote operating mode is set: TV, VCR, etc.■ Install new batteries.
TV turns off suddenly	<ul style="list-style-type: none">■ Is the sleep timer set?■ Check the power control settings. Power interrupted.■ No broadcast on station tuned with Auto sleep activated.

The video function does not work.	
No picture & No sound	<ul style="list-style-type: none">■ Check whether the product is turned on.■ Try another channel. The problem may be with the broadcast.■ Is the power cord inserted into wall power outlet?■ Check your antenna direction and/or location.■ Test the wall power outlet, plug another product's power cord into the outlet where the product's power cord was plugged in.
Picture appears slowly after switching on	<ul style="list-style-type: none">■ This is normal, the image is muted during the product startup process. If the picture does not appear after a minute, unplug the TV for 30 seconds and try it again. If the picture still doesn't appear, contact an authorized service center in your area.
No color, poor color, or poor picture	<ul style="list-style-type: none">■ Adjust Color in the menu.■ Keep a sufficient distance between this product and other electronics.■ Try another channel. The problem may be with the broadcast.■ Are the video cables installed properly?
Horizontal/vertical bars or picture shaking	<ul style="list-style-type: none">■ Check for local interference such as an electrical appliance or power tool.
Poor reception on some channels	<ul style="list-style-type: none">■ Station or cable product experiencing problems, tune to another station.■ Station signal is weak, reorient antenna.■ Check for sources of possible interference.
Lines or streaks in pictures	<ul style="list-style-type: none">■ Check antenna (Change the direction of the antenna).

APPENDIX

No Audio.	
Picture OK but no sound	<ul style="list-style-type: none">■ Press the VOL + or - button.■ Sound muted? Press MUTE button.■ Try another channel. The problem may be with the broadcast.■ Are the audio cables installed properly?
No output from one of the speakers	<ul style="list-style-type: none">■ Adjust Balance in menu option.
Unusual sound from inside the product	<ul style="list-style-type: none">■ A change in ambient humidity or temperature may result in an unusual noise when the product is turned on or off and does not indicate a problem with the product.

When using PC input (RGB or DVI)

No Video.	
Power is on, power indicator is blue but the screen appears extremely dark.	<ul style="list-style-type: none">■ Adjust brightness and contrast again.
Does the power indicator look amber?	<ul style="list-style-type: none">■ If the product is in power saving mode, move the mouse or press any key.
Does the 'Out of range' message appear?	<ul style="list-style-type: none">■ The signal from the PC (Video card) is out of the vertical or horizontal frequency range of the product. Adjust the video settings on the PC to match one of accepted resolution/frequency settings listed in this manual.
Does the 'Check signal cable' message appear?	<ul style="list-style-type: none">■ The signal cable between PC and product is not connected. Check the signal cable.■ Press the 'INPUT' button in the remote control to check the input source setting.

APPENDIX

'Unknown Product' message appears when the product is connected.

Did you install the driver?	<ul style="list-style-type: none">■ Install the product driver, which is provided with the product, or download it from the web site. (http://www.lge.com)■ The Video card in the PC is not properly communicating with the monitor. Try installing the latest drivers for the video card.
-----------------------------	--

After-image appears on the screen.

After-image appears when the product is turned off.	<ul style="list-style-type: none">■ The pixels may have been damaged if there was fixed image on the display for a long time. Use a screen saver.
---	---

Screen color is abnormal.

Screen has poor color resolution (16_colors).	<ul style="list-style-type: none">■ Set screen color resolution to 24 bits (true Color) or more using the display settings on the PC.
Screen color is unstable or mono color.	<ul style="list-style-type: none">■ Check the connection status of the signal cable.
Do back spots appear on the screen?	<ul style="list-style-type: none">■ Several pixels (red, green, white or black color) may appear on the screen, which can be attributable to the unique characteristics of the LCD panel. It is not a malfunction of the LCD.

RGB PC Mode

The screen image looks abnormal.

Is the picture offset?	<ul style="list-style-type: none">■ Adjust the Position menu in OSD.■ See if the video card resolution and frequency are supported by the product. If the frequency is out of range, set to the recommended resolution using the display settings on the PC.
Do thin lines appear on the background screen?	<ul style="list-style-type: none">■ Adjust the Clock menu in OSD.
Horizontal noise appears or the characters look blurred.	<ul style="list-style-type: none">■ Adjust the Phase menu in OSD.

APPENDIX

MAINTENANCE

Careful and regular cleaning can extend the amount of time you can enjoy your new set.

Caution: Be sure to turn the power off and unplug the power cord before you begin any cleaning.

Cleaning the Screen

- 1 To keep the dust off your screen for a while, wet a soft cloth in a mixture of lukewarm water and a little fabric softener or dishwashing detergent. Wring the cloth until it's almost dry, and then use it to wipe the screen.
- 2 Make sure the excess water is off the screen, and then let it air-dry before you turn on your set.

Cleaning the Cabinet

- To remove dirt or dust, wipe the cabinet with a soft, dry, lint-free cloth.
- Please be sure not to use a wet cloth.

Extended Absence

CAUTION

- ▶ If you expect to leave your set dormant for a long time (such as a vacation), it's a good idea to unplug the power cord to protect against possible damage from lightning or power surges.

APPENDIX

PRODUCT SPECIFICATIONS

<M2262D>

LCD Panel	Screen Type	546.86 mm Wide (21.53 inch) TFT (Thin Film Transistor) LCD (Liquid Crystal Display) Panel Visible diagonal size : 546.86 mm
	Pixel Pitch	0.248 mm (H) x 0.248 mm (V)
Video Signal	Max. Resolution	1920 x 1080 @ 60 Hz
	Recommended Resolution	1920 x 1080 @ 60 Hz
	Horizontal Frequency	30 kHz to 83 kHz
	Vertical Frequency	56 Hz to 75 Hz
	Synchronization Type	Separate Sync, Digital
Input Connector		TV, D-Sub Analog, PC Audio In, component, DVI-D, HDMI*2, CVBS, S-VIDEO
Power	Rated Voltage	AC 100-240 V~ 50 / 60 Hz 0.9A
	Power Consumption	On Mode : 50 W (typ.) Sleep Mode ≤ 1 W(RGB) Off Mode ≤ 1 W
Tilt	Tilt Range	-5° to 15°
Dimensions (Width x Height x Depth) Weight		517.2 mm x 399.8 mm x 221.6 mm (20.36 inch x 15.74 inch x 8.72 inch) 4.7 kg (10.4 lb)
Environmental conditions	Operating Temperature	10 °C to 35 °C
	Operating Humidity	20 % to 80 %
	Storage Temperature	-10 °C to 60 °C
	Storage Humidity	5 % to 90 %

- The specifications shown above may be changed without prior notice for quality improvement.

APPENDIX

PRODUCT SPECIFICATIONS

<M2362D>

LCD Panel	Screen Type	584.2 mm Wide (23 inch) TFT (Thin Film Transistor) LCD (Liquid Crystal Display) Panel Visible diagonal size : 584.2 mm
	Pixel Pitch	0.265 mm (H) x 0.265 mm (V)
Video Signal	Max. Resolution	1920 x 1080 @ 60 Hz
	Recommended Resolution	1920 x 1080 @ 60 Hz
	Horizontal Frequency	30 kHz to 83 kHz
	Vertical Frequency	56 Hz to 75 Hz
	Synchronization Type	Separate Sync, Digital
Input Connector		TV, D-Sub Analog, PC Audio In, component, DVI-D, HDMI*2, CVBS, S-VIDEO
Power	Rated Voltage	AC 100-240 V~ 50 / 60 Hz 1.0 A
	Power Consumption	On Mode : 55 W (typ.) Sleep Mode ≤ 1 W(RGB) Off Mode ≤ 1 W
Tilt	Tilt Range	-5° to 15°
Dimensions (Width x Height x Depth) Weight		551.8 mm x 419.5 mm x 221.6 mm (21.72 inch x 16.52 inch x 8.72 inch) 5.2 kg (11.46 lb)
Environmental conditions	Operating Temperature	10 °C to 35 °C
	Operating Humidity	20 % to 80 %
	Storage Temperature	-10 °C to 60 °C
	Storage Humidity	5 % to 90 %

■ The specifications shown above may be changed without prior notice for quality improvement.

APPENDIX

PRODUCT SPECIFICATIONS

<M2762D>

LCD Panel	Screen Type	686 mm Wide (27 inch) TFT (Thin Film Transistor) LCD (Liquid Crystal Display) Panel Visible diagonal size : 686 mm
	Pixel Pitch	0.3114 mm (H) x 0.3114 mm (V)
Video Signal	Max. Resolution	1920 x 1080 @ 60 Hz
	Recommended Resolution	1920 x 1080 @ 60 Hz
	Horizontal Frequency	30 kHz to 83 kHz
	Vertical Frequency	56 Hz to 75 Hz
	Synchronization Type	Separate Sync, Digital
Input Connector		TV, D-Sub Analog, PC Audio In, component, DVI-D, HDMI*2, CVBS, S-VIDEO
Power	Rated Voltage	AC 100-240 V~ 50 / 60 Hz 1.2 A
	Power Consumption	On Mode : 65 W (typ.) Sleep Mode ≤ 1 W(RGB) Off Mode ≤ 1 W
Tilt	Tilt Range	-5° to 15°
Dimensions (Width x Height x Depth) Weight		649.1 mm x 485 mm x 210 mm (25.56 inch x 19.09 inch x 8.27 inch) 7.2 kg (15.87 lb)
Environmental conditions	Operating Temperature	10 °C to 35 °C
	Operating Humidity	20 % to 80 %
	Storage Temperature	-10 °C to 60 °C
	Storage Humidity	5 % to 90 %

■ The specifications shown above may be changed without prior notice for quality improvement.

APPENDIX

PROGRAMMING THE REMOTE CONTROL

The remote is a multi-brand or universal remote. It can be programmed to operate most remote-controllable devices of other manufacturers.

Note that the remote may not control all models of other brands.

Programming a code into a remote mode

- 1 To find out whether your remote control can operate the component without programming, turn on the component such as a VCR and press the corresponding mode button (such as a **DVD** or **VCR**) on the remote control. While pointing at the component, test the **POWER** and **CH + / -** buttons to see if the component responds properly. If not, the remote requires programming to operate the device.
- 2 Turn on the component to be programmed, then press the corresponding mode button (such as a **DVD** or **VCR**) on the remote control. The remote control button of desired device is lighted.
- 3 Press the **MENU** and **MUTE** buttons simultaneously. Now the remote control is ready to be programmed with the new code.
- 4 Enter a code number using the number buttons on the remote control. Programming code numbers for the corresponding component can be found on the following pages. If the code is correct, the device will turn off.
- 5 Press the **MENU** button to store the code.
- 6 Test the remote control functions to see if the component responds properly. If not, repeat from step 2.

PROGRAMMING CODE

DVD

Brand	Codes	Brand	Codes	Brand	Codes
APEX DIGITAL	022	mitsubishi	002	RCA	005 006
DENON	020 014	NAD	023	SAMSUNG	011 015
GE	005 006	ONKYO	008 017	SONY	007
HARMAN KARDON	027	PANASONIC	003 009	THOMPSON	005 006
JVC	012	PHILIPS	013	TOSHIBA	019 008
LG	001 010 016 025	PIONEER	004 026	YAMAHA	009 018
MAGNAVOX	013	PROCEED	021	ZENITH	010 016 025
MARANTZ	024	PROSCAN	005 006		

APPENDIX

VCR

Brand	Codes	Brand	Codes	Brand	Codes
AIWA	034	MAGNAVOX	031 033 034 041	SAMSUNG	032 040 102 104
AKAI	016 043 046 124 125 146		067 068		105 107 109 112
AMPRO	072	MARANTZ	012 031 033 067 069		113 115 120 122 125
ANAM	031 033 103	MARTA	101	SANSUI	022 043 048 135
AUDIO DYNAMICS	012 023 039 043	MATSUI	027 030	SANYO	003 007 010 014
BROKSONIC	035 037 129	MEI	031 033		102 134
CANON	028 031 033	MEMOREX	003 010 014 031 033 034 053 072 101 102 134 139	SCOTT	017 037 112 129 131
CAPEHART	108			SEARS	003 008 009 010 013 014 017 020 031 042 073 081 101
CRAIG	003 040 135	MGA	045 046 059		031 054 149
CURTIS MATHES	031 033 041	MINOLTA	013 020	SHINTOM	024
DAEWOO	005 007 010 064 065 108 110 111 112 116 117 119	MITSUBISHI	013 020 045 046 049 051 059 061 151	SONY	003 009 031 052 056 057 058 076 077 078 149
DAYTRON	108	MTC	034 040	SOUNDESIGN	034
DBX	012 023 039 043	MULTITECH	024 034	STS	013
DYNATECH	034 053	NEC	012 023 039 043 048	SYLVANIA	031 033 034 059 067
ELECTROHOME	059	NORDMENDE	043	SYMPHONIC	034
EMERSON	006 017 025 027 029 031 034 035 036 037 046 101 129 131 138 153	OPTONICA	053 054	TANDY	010 034
FISHER	003 008 009 010	PANASONIC	066 070 074 083 133 140 145	TATUNG	039 043
FUNAI	034			TEAC	034 039 043
GE	031 033 063 072 107 109 144 147	PENTAX	013 020 031 033 063	TECHNICS	031 033 070
GO VIDEO	132 136	PHILCO	031 034 067	TEKNIKA	019 031 033 034 101
HARMAN KARDON	012 045	PHILIPS	031 033 034 054 067 071 101	THOMAS	034
HITACHI	004 018 026 034 043 063 137 150	PILOT	101	TMK	006
INSTANTREPLAY	031 033	PIONEER	013 021 048	TOSHIBA	008 013 042 047 059 082 112 131
JCL	031 033	PORTLAND	108		040 101
JCPENNY	012 013 015 033 040 066 101	PULSAR	072	TOTEVISION	040 101
JENSEN	043	QUARTZ	011 014	UNITECH	040
JVC	012 031 033 043 048 050 055 060 130 150 152	QUASAR	033 066 075 145	VECTOR RESEARCH	012
KENWOOD	014 034 039 043 047 048	RCA	013 020 033 034 040 041 062 063 107 109 140 144 145 147	VICTOR	048
LG (GOLDSTAR)	001 012 013 020 101 106 114 123	REALISTIC	003 008 010 014 031 033 034 040 053 054 101	VIDEO CONCEPTS	012 034 046
LLOYD	034			VIDEOSONIC	040
LXI	003 009 013 014 017 034 101 106	RICO	058	WARDS	003 013 017 024 031 033 034 040 053 054 131
MAGIN	040	RUNCO	148	YAMAHA	012 034 039 043
		SALORA	014	ZENITH	034 048 056 058 072 080 101

APPENDIX

IR CODES

1. How to Connect

- Connect your wired remote control to the Remote Control port on the set.

2. Remote Control IR Codes

- Output waveform

Single pulse, modulated with 37.917 kHz signal at 455 kHz



- Configuration of frame

1st frame

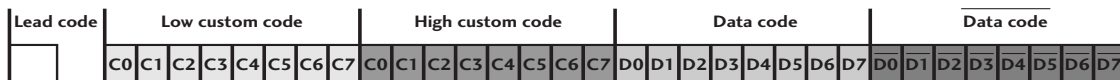

Repeat frame

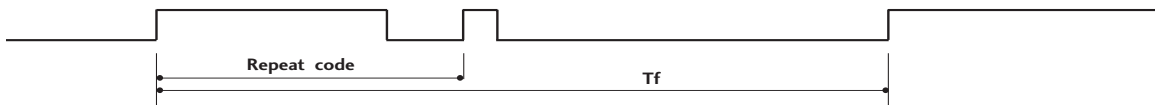

- Lead code

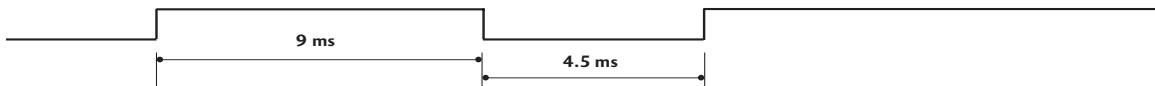

- Repeat code

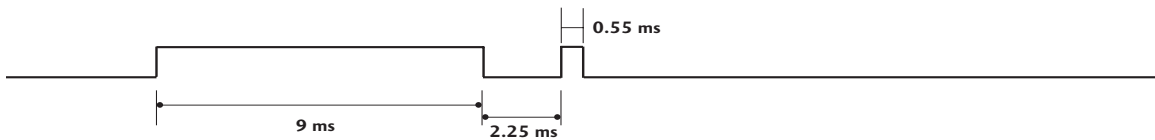

- Bit description

Bit "0"

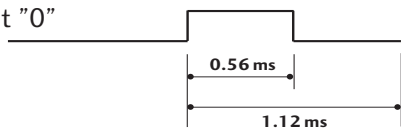

Bit "1"

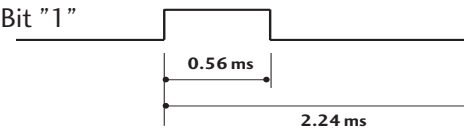

- Frame interval: Tf

The waveform is transmitted as long as a key is depressed.

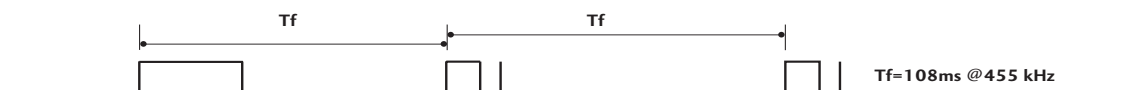

APPENDIX

EXTERNAL CONTROL DEVICE SETUP

RS-232C Setup

Connect the RS-232C (serial port) input jack to an external control device (such as a computer or an A/V control system) to control the product's functions externally.

Connect the serial port of the control device to the RS-232C jack on the product back panel.

Note: RS-232C on this unit is intended to be used with third party RS-232C control hardware and software. The instructions below are provided to help with programming software or to test functionality using telenet software. RS-232C connection cables are not supplied with the product.

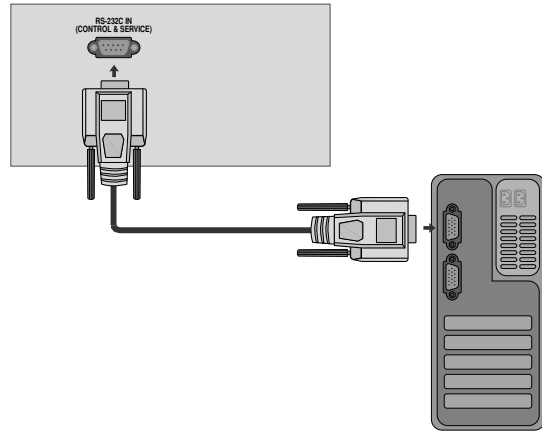

Type of Connector; D-Sub 9-Pin Male

No.	Pin Name
1	No connection
2	RXD (Receive data)
3	TXD (Transmit data)
4	DTR (DTE side ready)
5	GND
6	DSR (DCE side ready)
7	RTS (Ready to send)
8	CTS (Clear to send)
9	No Connection

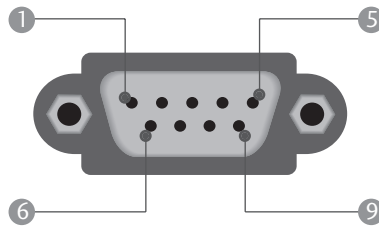

RS-232C Configurations

7-Wire Configuration (Serial female-female NULL modem cable)

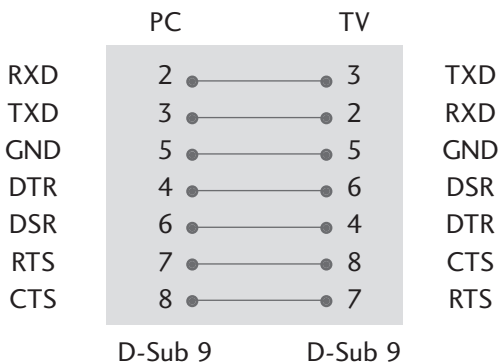

3-Wire Configurations (Not standard)

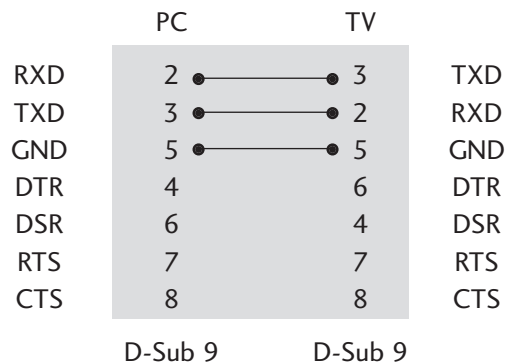





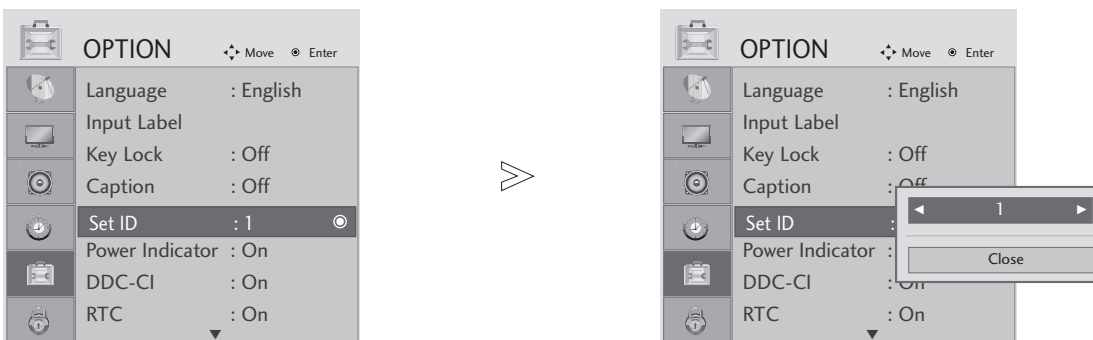

APPENDIX

Set ID

Use this function to specify a set ID number.
Refer to 'Real Data Mapping' ▶ p.93



- 1   Select **OPTION**.
- 2   Select **Set ID**.
- 3   adjust **Set ID** to choose the desired set ID number.
The adjustment range of SET ID is 1 to 99.

- Press the MENU button to close the menu window.
- Press the RETURN button to move to the previous menu screen.

APPENDIX

Command Reference List

	COMMAND1	COMMAND2	DATA (Hexadecimal)		COMMAND1	COMMAND2	DATA (Hexadecimal)
01. Power	k	a	00 to 01	14. Treble	k	r	00 to 64
02. Input Select	x	b	(▶ p.92)	15. Bass	k	s	00 to 64
03. Aspect Ratio	k	c	(▶ p.92)	16. Balance	k	t	00 to 64
04. Screen Mute	k	d	00 to 01	17. Color Temperature	k	u	00 to 02
05. Volume Mute	k	e	00 to 01	18. Auto Configuration	j	u	(▶ p.93)
06. Volume Control	k	f	00 to 64	20. Channel Add/Del	m	b	00 to 01
07. Contrast	k	g	00 to 64	21. Key	m	c	(▶ p.94)
08. Brightness	k	h	00 to 64	22. Backlight	m	g	00 to 64
09. Color	k	i	00 to 64				
10. Tint	k	j	00 to 64				
11. Sharpness	k	k	00 to 64				
12. OSD Select	k	l	00 to 01				
13. Remote Control Lock Mode	k	m	00 to 01				

	COMMAND1	COMMAND2	DATA00 (Hexadecimal)	DATA01 (Hexadecimal)	DATA02 (Hexadecimal)	DATA03 (Hexadecimal)	DATA04 (Hexadecimal)	DATA05 (Hexadecimal)
19. Channel Tuning	m	a	physical program high	major program low	major low	minor high	minor low	attribute

Transmission / Receiving Protocol

Transmission

[Command1][Command2][][Set ID][][Data][Cr]

[Command 1] : First command to control the set.(j, k, m or x)

[Command 2] : Second command to control the set.

[Set ID] : You can adjust the set ID to choose desired set ID number in Option menu. Adjustment range is 1 to 99. When selecting Set ID '0', every connected the set is controlled. Set ID is indicated as decimal (1 to 99) on menu and as Hexa decimal (0x0 to 0x63) on transmission /receiving protocol.

[DATA] : To transmit the command data.

Transmit the 'FF' data to read status of command.

[Cr] : Carriage Return

ASCII code '0x0D'

[] : ASCII code 'space (0x20)'

* In this model, set will not send the status during the standby mode.

OK Acknowledgement

[Command2][][Set ID][][OK][Data][x]

The set transmits ACK (acknowledgement) based on this format when receiving normal data. At this time, if the data is data read mode, it indicates present status data. If the data is data write mode, it returns the data of the PC computer.

* In this model, set will not send the status during the standby mode.

* Data Format

[Command 2] : Use as command.

[Set ID] : Use the small character, if set ID is 10, it will send the '0', 'a'.

[DATA] : Use the small character, if data is 0 x ab, it will send the 'a', 'b'.

[OK] : Use the large character.

Error Acknowledgement

[Command2][][Set ID][][NG][Data][x]

The set transmits ACK (acknowledgement) based on this format when receiving abnormal data from non-viable functions or communication errors.

Data1: Illegal Code

Data2: Not supported function

Data3: Wait more time

* In this model, set will not send the status during the standby mode.

* Data Format

[Command 2] : Use as command.

[Set ID] : Use the small character, if set ID is 10, it will send the '0', 'a'.

[DATA] : Use the small character, if data is 0 x ab, it will send the 'a', 'b'.

[NG] : Use the large character

APPENDIX

01. Power (Command: k a)

To control Power On/Off of the set.

Transmission [k][a][][Set ID][][Data][Cr]

Data 00: Power Off Data 01: Power On

Acknowledgement [a][][Set ID][][OK/NG][Data][x]

* In a like manner, if other functions transmit 'FF' data based on this format, Acknowledgement data feedback presents status about each function.

* Note: In this model, set will send the Acknowledge after power on processing completion.

There might be a time delay between command and acknowledge.

02. Input Select (Command: x b)

To select input source for set.

Transmission [x][b][][Set ID][][Data][Cr]

Data 00: DTV (Antenna) Data 01: DTV (Cable)

Data 10: Analog (Antenna) Data 11: Analog (Cable)

Data 20: AV Data 40: Component

Data 60: RGB-PC Data 70: DVI

Data 90: HDMI1 Data 91: HDMI2

Acknowledgement [b][][Set ID][][OK/NG][Data][x]

03. Aspect Ratio (Command: k c)

To adjust the screen format.

Transmission [k][c][][Set ID][][Data][Cr]

Data 01: 4:3 06: Set by program

02: 16:9 04: Zoom 1

09: Just scan 05: Zoom 2

⋮

Reserved

Acknowledgement [c][][Set ID][][OK/NG][Data][x]

04. Screen Mute (Command: k d)

To select screen mute on/off.

Transmission [k][d][][Set ID][][Data][Cr]

Data 00: Screen mute off (Picture on)

Data 01: Screen mute on (Picture off)

Acknowledgement [d][][Set ID][][OK/NG][Data][x]

05. Volume Mute (Command: k e)

To control volume mute on/off.

You can also adjust mute using the MUTE button on remote control.

Transmission [k][e][][Set ID][][Data][Cr]

Data 00: Volume mute on (Volume off)

Data 01: Volume mute off (Volume on)

Acknowledgement [e][][Set ID][][OK/NG][Data][x]

06. Volume Control (Command: k f)

To adjust volume.

You can also adjust volume with the volume buttons on remote control.

Transmission [k][f][][Set ID][][Data][Cr]

Data Min: 00 to Max: 64 (*transmit by Hexadecimal code)

*Refer to 'Real data mapping'. See page 93.

Acknowledgement [f][][Set ID][][OK/NG][Data][x]

07. Contrast (Command: k g)

To adjust screen contrast.

You can also adjust contrast in the PICTURE menu.

Transmission [k][g][][Set ID][][Data][Cr]

Data Min: 00 ~ Max: 64 (*transmit by Hexadecimal code)

*Refer to 'Real data mapping'. See page 93.

Acknowledgement [g][][Set ID][][OK/NG][Data][x]

08. Brightness (Command: k h)

To adjust screen brightness.

You can also adjust brightness in the PICTURE menu.

Transmission [k][h][][Set ID][][Data][Cr]

Data Min: 00 to Max: 64 (*transmit by Hexadecimal code)

*Refer to 'Real data mapping'. See page 93.

Acknowledgement [h][][Set ID][][OK/NG][Data][x]

09. Color (Command: k i)

To adjust screen color.

You can also adjust color in the PICTURE menu.

Transmission [k][i][][Set ID][][Data][Cr]

Data Min: 00 to Max: 64 (*transmit by Hexadecimal code)

*Refer to 'Real data mapping'. See page 93.

Acknowledgement [i][][Set ID][][OK/NG][Data][x]

10. Tint (Command: k j)

To adjust screen tint.

You can also adjust tint in the PICTURE menu.

Transmission [k][j][][Set ID][][Data][Cr]

Data Red: 00 to Green: 64 (*transmit by Hexadecimal code)

*Refer to 'Real data mapping'. See page 93.

Acknowledgement [j][][Set ID][][OK/NG][Data][x]

11. Sharpness (Command: k k)

To adjust screen sharpness.

You can also adjust sharpness in the PICTURE menu.

Transmission [k][k][][Set ID][][Data][Cr]

Data Min: 00 to Max: 64 (*transmit by Hexadecimal code)

*Refer to 'Real data mapping'. See page 93.

Acknowledgement [k][][Set ID][][OK/NG][Data][x]

APPENDIX

12. OSD Select (Command: k l)

To select OSD (On Screen Display) on/off.

Transmission [k][l][][Set ID][][Data][Cr]

Data 00: OSD off Data 01: OSD on

Acknowledgement [l][][Set ID][][OK/NG][Data][x]

13. Remote Control Lock Mode (Command: k m)

To lock the remote control and the front panel controls on the set.

Transmission [k][m][][Set ID][][Data][Cr]

Data 00: Lock off Data 01: Lock on

Acknowledgement [m][][Set ID][][OK/NG][Data][x]

If you're not using the remote control and front panel controls on the TV, use this mode. When main power is on/off, remote control lock is released.

14. Treble (Command: k r)

To adjust treble.

You can also adjust treble in the AUDIO menu.

Transmission [k][r][][Set ID][][Data][Cr]

Data Min: 00 to Max: 64 (*transmit by Hexadecimal code)

*Refer to 'Real data mapping' as shown.

Acknowledgement [r][][Set ID][][OK/NG][Data][x]

15. Bass (Command: k s)

To adjust bass.

You can also adjust bass in the AUDIO menu.

Transmission [k][s][][Set ID][][Data][Cr]

Data Min: 00 to Max: 64 (*transmit by Hexadecimal code)

*Refer to 'Real data mapping' as shown.

Acknowledgement [s][][Set ID][][OK/NG][Data][x]

16. Balance (Command: k t)

To adjust balance.

You can also adjust balance in the AUDIO menu.

Transmission [k][t][][Set ID][][Data][Cr]

Data Min: 00 to Max: 64 (*transmit by Hexadecimal code)

*Refer to 'Real data mapping' as shown.

Acknowledgement [t][][Set ID][][OK/NG][Data][x]

17. Color Temperature (Command: k u)

To adjust color temperature.

You can also adjust color temperature in the PICTURE menu.

Transmission [k][u][][Set ID][][Data][Cr]

Data 00: Medium 01: Cool 02: Warm

Acknowledgement [u][][Set ID][][OK/NG][Data][x]

18. Auto Configuration (Command: j u)

To adjust picture position and minimize image shaking automatically. Auto configuration only works in RGB-PC mode.

Transmission [j][u][][Set ID][][Data][Cr]

Data 01: To set

Acknowledgement [u][][Set ID][][OK/NG][Data][x]

```
*Real data mapping
0 : Step 0
  ⋮
A : Step 10 (SET ID 10)
  ⋮
F : Step 15 (SET ID 15)
10 : Step 16 (SET ID 16)
  ⋮
63 : Step 99 (SET ID 99)
64 : Step 100
```

19. Channel Tuning (Command: m a)

To tune channel to following physical/major/minor number.

Transmission [m][a][][Set ID][][Data00][][Data01][][Data02][][Data03][][Data04][][Data05][Cr]

Digital channels have a Physical, Major, and Minor channel number. The Physical number is the actual digital channel number, the Major is the number that the channel should be mapped to, and the Minor is the sub-channel. Since the ATSC tuner automatically maps the channel to the Major number, the Physical number is not required when sending a command.

Data 00: Physical Channel Number NTSC air: 02

- Open the battery compartment cover on the back and install the batteries matching correct polarity (+ with +, - with -).

- Install two 1.5 V AAA batteries. Don't mix old or used batteries with new ones.

- Close cover.

- To remove the batteries, perform the installation actions in reverse. 45,

NTSC air : 02 to 45, cable: 01, 0E to 7D

ATSC air : 01 to 45, ATSC cable: 01 to 87

Data 01 & 02: Major Channel Number

Data 01: High byte Data 02: Low byte

Two bytes are available for the Major and Minor, normally only the second byte is used.

Data 03 & 04: Minor Channel Number

Not needed for NTSC.

APPENDIX

Data5:

7	Main/Sub Picture	6	Two/One Part Channel	5	Using Physical Channel	4	Reserved	3	2	1	0	Step
0	Main	0	Two	0	Use	x		0	0	0	0	NTSC Air
1	Sub	1	One	1	No Use	x		0	0	0	1	NTSC Cable
						x		0	0	1	0	ATSC Air
						x		0	0	1	1	ATSC Cable_std
						x		0	1	0	0	ATSC Cable_hrc
						x		0	1	0	1	ATSC Cable_irc
						x		0	1	1	0	ATSC cable_auto
						x		0	1	1	1	Reserved
						x		x	x	x	x	...
						x		1	1	1	1	Reserved

The table above lists the binary code which must be converted to Hexadecimal before sending. For example: The binary code to tune the sub source to an NTSC cable channel is "1000 0001", which translates to "81" in Hex.

- * 7th bit : For which source do you want to change the channel.
- * 6th bit: Use a two part or one part channel. Most cases just use 0 since it's ignored when using NTSC.
- * 5th bit: Use 0 with NTSC since it can only use the physical channel number. Normally use 1 for ATSC since most times it doesn't matter what the physical number is.
- * 4th bit: Set to 0.
- * 3-0 bits: Choose signal type.

* Tune Command Examples:

1. Tune to the analog (NTSC) cable channel 35.

Data 00 = Physical of 35 = 23
 Data 01 & 02 = No Major = 00 00
 Data 03 & 04 = No Minor = 00 00
 Data 05 = 0000 0001 in binary = 01
 Total = ma 00 23 00 00 00 00 01

2. Tune to the digital (ATSC) local channel 30-3.

Data 00 = Don't know Physical = 00
 Data 01 & 02 = Major is 30 = 00 1E
 Data 03 & 04 = Minor is 3 = 00 03
 Data 05 = 0010 0010 in binary = 22
 Total = ma 00 00 00 1E 00 03 22

```
Acknowledgement[a][ ][Set ID][
][OK][Data00][Data01 ]
[Data02][Data03][Data04][x][a][ ][Set ID]
][ ][NG][Data00][x]
```

20. Channel Add/Del (Command: m b)

To add and delete the channels.

```
Transmission [m][b][ ][Set ID][ ][Data][Cr]
```

Data 00: Channel Delete Data 01: Channel Add

```
Acknowledgement [b][ ][Set ID][ ][OK/NG][Data][x]
```

21. Key (Command: m c)

To send IR remote key code.

```
Transmission [m][c][ ][Set ID][ ][Data][Cr]
```

```
Acknowledgement [c][ ][Set ID][ ][OK/NG][Data][x]
```

Code (Hexa)	Remote control	Code (Hexa)	Remote control
0F	TV/PC	40	^
0B	INPUT	41	v
08	POWER	07	<
79	RATIO	06	>
10-19	Number Key 0-9	44	ENTER
4C	- (Dash)	43	MENU
09	MUTE	45	Q.MENU
02	VOL +	52	SOUND
03	VOL -	4D	PICTURE
00	CH +	5B	RETURN
01	CH -	0A	SAP
1E	FAV	1A	FLASHBK
73	LIGHTING		

22. Backlight (Command: m g)

To adjust screen backlight.

```
Transmission [m][g][ ][Set ID][ ][Data][Cr]
```

Data Min:00 to Max:64 (*transmit by Hexadecimal code)

*Refer to 'Real data mapping'. See page 93.

```
Acknowledgement [g][ ][Set ID][ ][OK/NG][Data][x]
```

CHILD SAFETY:

It Makes A Difference How and Where
You Use Your Flat Panel Display

Congratulations on your purchase! As you enjoy your new product, please keep these safety tips in mind:



THE ISSUE

- The home theater entertainment experience is a growing trend and larger flat panel displays are popular purchases. However, flat panel displays are not always supported on the proper stands or installed according to the manufacturer's recommendations.
- Flat panel displays that are inappropriately situated on dressers, bookcases, shelves, desks, speakers, chests or carts may fall over and cause injury.

THIS MANUFACTURER CARES!

- The consumer electronics industry is committed to making home entertainment enjoyable and safe.

TUNE INTO SAFETY

- One size does NOT fit all. Follow the manufacturer's recommendations for the safe installation and use of your flat panel display.
- Carefully read and understand all enclosed instructions for proper use of this product.
- Don't allow children to climb on or play with furniture and television sets.
- Don't place flat panel displays on furniture that can easily be used as steps, such as a chest of drawers.
- Remember that children can become excited while watching a program, especially on a "larger than life" flat panel display. Care should be taken to place or install the display where it cannot be pushed, pulled over, or knocked down.
- Care should be taken to route all cords and cables connected to the flat panel display so that they cannot be pulled or grabbed by curious children.

WALL MOUNTING: IF YOU DECIDE TO WALL MOUNT YOUR FLAT PANEL DISPLAY, ALWAYS:

- Use a mount that has been recommended by the display manufacturer and/or listed by an independent laboratory (such as UL, CSA, ETL).
- Follow all instructions supplied by the display and wall mount manufacturers.
- If you have any doubts about your ability to safely install your flat panel display, contact your retailer about professional installation.
- Make sure that the wall where you are mounting the display is appropriate. Some wall mounts are not designed to be mounted to walls with steel studs or old cinder block construction. If you are unsure, contact a professional installer.
- A minimum of two people are required for installation. Flat panel displays can be heavy.



 **CEA**
Consumer Electronics Association
www.CE.org/safety

P/NO : 3840TRL098E (0801-REV00)



Make sure to read the Safety Precautions before using the product.
Keep the User's Guide(CD) in an accessible place for future reference.
The model and serial number of the SET is located on the back and one side of the SET.
Record it below should you ever need service.

MODEL _____

SERIAL _____