

FM/AM Clock Radio

Operating Instructions

US

ICF-CL75iP/ICF-CL70
DREAM MACHINE



Owner's Record

The model number and the serial number are located on the bottom.

Record the serial number in the space provided below. Refer to them whenever you call upon your Sony dealer regarding this product.

Model No. ICF-CL75iP/ICF-CL70

Serial No. _____

For customers who purchased this product in the USA

Please register this product on line at <http://www.sony.com/productregistration>.

Proper registration will enable us to send you periodic mailings about new products, services, and other important announcements. Registering your product will also allow us to contact you in the unlikely event that the product needs adjustment or modification. Thank you.

WARNING

To reduce the risk of fire or electric shock, do not expose this apparatus to rain or moisture.

To reduce the risk of fire, do not cover the ventilation of the apparatus with newspapers, tablecloths, curtains, etc. And do not place lighted candles on the apparatus.

To reduce the risk of fire or electric shock, do not expose this apparatus to dripping or splashing, and do not place objects filled with liquids, such as vases, on the apparatus.

As the main plug is used to disconnect the unit from the mains, connect the unit to an easily accessible AC outlet. Should you notice an abnormality in the unit, disconnect the main plug from the AC outlet immediately.

The unit is not disconnected from the AC power source (mains) as long as it is connected to the wall outlet, even if the unit itself has been turned off.

Do not install the appliance in a confined space, such as a bookcase or built-in cabinet.

Do not expose the batteries (battery pack or batteries installed) to excessive heat such as sunshine, fire or the like for a long time.

You are cautioned that any changes or modifications not expressly approved in this manual could void your authority to operate this equipment.

The nameplate and important information concerning safety are located on the bottom exterior.

CAUTION

Danger of explosion if battery is incorrectly replaced. Replace only with the same type.

NOTE

This equipment has been tested and found to comply with the limits for a Class B digital device, pursuant to Part 15 of the FCC Rules. These limits are designed to provide reasonable protection against harmful interference in a residential installation. This equipment generates, uses and can radiate radio frequency energy and, if not installed and used in accordance with the instructions, may cause harmful interference to radio communications. However, there is no guarantee that interference will not occur in a particular installation. If this equipment does cause harmful interference to radio or television reception, which can be determined by turning the equipment off and on, the user is encouraged to try to correct the interference by one or more of the following measures:

- Reorient or relocate the receiving antenna.
- Increase the separation between the equipment and receiver.
- Connect the equipment into an outlet on a circuit different from that to which the receiver is connected.
- Consult the dealer or an experienced radio/TV technician for help.

WARNING

- Replace the battery for the clock backup with a Sony CR2032 lithium battery. Use of another battery may present a risk of fire or explosion.
- Battery may explode if mistreated. Do not recharge, disassemble or dispose of in fire.
- Dispose of used battery promptly. Keep away from children.

Important Safety Instructions

- 1) Read these instructions.
- 2) Keep these instructions.
- 3) Heed all warnings.
- 4) Follow all instructions.
- 5) Do not use this apparatus near water.
- 6) Clean only with dry cloth.
- 7) Do not block any ventilation openings.
Install in accordance with the manufacturer's instructions.
- 8) Do not install near any heat sources such as radiators, heat registers, stoves, or other apparatus (including amplifiers) that produce heat.
- 9) Do not defeat the safety purpose of the polarized or grounding-type plug. A polarized plug has two blades with one wider than the other. A grounding type plug has two blades and a third grounding prong. The wide blade or the third prong are provided for your safety.
If the provided plug does not fit into your outlet, consult an electrician for replacement of the obsolete outlet.
- 10) Protect the power cord from being walked on or pinched particularly at plugs, convenience receptacles, and the point where they exit from the apparatus.
- 11) Only use attachments/accessories specified by the manufacturer.
- 12) Use only with the cart, stand, tripod, bracket, or table specified by the manufacturer, or sold with the apparatus. When a cart is used, use caution when moving the cart/apparatus combination to avoid injury from tip-over.



- 13) Unplug this apparatus during lightning storms or when unused for long periods of time.
- 14) Refer all servicing to qualified service personnel. Servicing is required when the apparatus has been damaged in any way, such as power-supply cord or plug is damaged, liquid has been spilled or objects have fallen into the apparatus, the apparatus has been exposed to rain or moisture, does not operate normally, or has been dropped.

For the state of california, USA only

Perchlorate Material –special handling may apply, See www.dtsc.ca.gov/hazardouswaste/perchlorate

Perchlorate Material: Lithium battery contains perchlorate.

Notes on LCD screen

- The displayed image on the screen is not identical in picture quality and colors with the printed image because phosphor methods or profiles differ. Please regard the displayed image as just a reference.
- Do not press against the LCD screen. The screen may be discolored and that may cause a malfunction.
- Exposing the LCD screen to direct sunlight for long periods may cause malfunctions.
- The LCD screen is manufactured using extremely high-precision technology, so over 99.99% of the pixels are operational for effective use. However, there may be some tiny black points and/or bright points (white, red, blue or green in color) that constantly appear on the LCD screen. These points are normal in the manufacturing process and do not affect the printing in any way.
- Images may trail across on the LCD screen in a cold location. This is not a malfunction.

US

About this Operating Instructions

- The example illustrations and images are of the ICF-CL75iP, therefore may appear different from illustrations, images and screen indicators that actually appear on your clock radio.
- “Note” indicates cautions and limitations relevant to the correct operation of this unit.
- “Tip” indicates information that is useful to know.
- The figures in parentheses indicate the reference page for details on operation.
- The language used for on-screen displays are English for all countries and regions.
- In this Operating Instructions, iPod is used as a general reference to iPod functions on iPod or iPhone, unless otherwise specified by the text or illustrations (ICF-CL75iP only).
- Design and specifications of this unit and accessories are subject to change without notice.

Table of Contents

Features	6
Identifying the parts	8
Screen indicators	10
Getting started	
Checking the supplied items	11
Connecting the AM antenna and AC power cord (mains lead) ...	11
Setting the clock	12
Using this unit	
Basic operations	14
Home and Option menu	14
Adjusting the volume	14
Adjusting the brightness	14
Changing the clock display type	15
Listening to the radio	15
Presetting a station.....	15
Using the timer function	16
Setting an alarm.....	16
Fun Wake-up	18
Using the sleep timer.....	19
Enjoying music, video and photos	19
Importing files	19
Playing back music, video and setting the background photo (wallpaper)	20
Using iPod & iPhone functions (For ICF-CL75iP only)	21
Compatible iPod models	21
Playing iPod	22
Additional information	
General Settings	24
Troubleshooting	25
About the memory cards	26
“Memory Stick” media.....	26
SD memory card.....	28
Precautions	29
Specifications	31

Features

This unit is multifunctional FM/AM clock radio with 7.0 inch LCD screen. As well as playing your favorite music and video, you can also set a photo as wallpaper, etc. You can listen to your favorite music, watch a video or view a slideshow at bed time and set your favorite alarm sound for when you wake up.

Furthermore, when you insert iPod into the docking tray, you can operate iPod via this unit or iPod directly (ICF-CL75iP only).

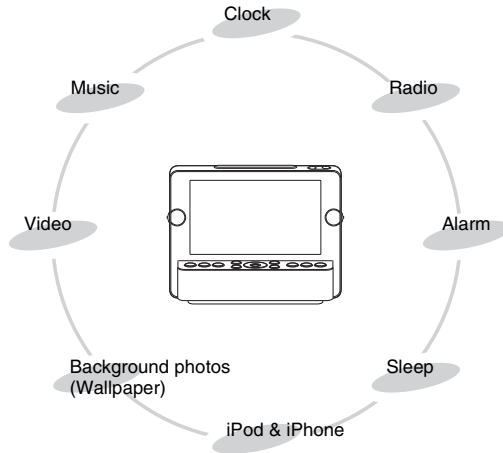

Operability (8, 16)

- Various useful functions available in the 7.0 inch LCD screen.
- Easy to turn on or off by pressing the ALARM button.
- Quick and easy alarm time setting using the TIME SET lever.

Screen-display (10, 14)

- LCD screen allows you to check the clock easily.
- The brightness of night mode shifts to sleep mode automatically to coincide with your bed time.
- Triple time display allows you to view your current time and 2 alarm times, at a glance.

Playback function (19, 20)

- iPod, iPhone, memory card, internal memory, or USB device can be used to play back music and video (iPod and iPhone functions only for ICF-CL75iP).
- You can listen to music with album artwork on the screen.
- 1 W × 1 W front speakers can be used to listen to sounds.
- You can save contents into the 1 GB internal memory.

Note

- You cannot display the album artwork of iPod or iPhone on this unit.
- You cannot display the cover photo for WMA content.

Background photos (20)

- Photos can be displayed as wallpaper on the screen, similar to a photo frame.
- Photo images can be played back as a slideshow.

Alarm/Sleep timer function (16)

- Using Fun Wake-up, you can wake up to your favorite recorded voice and photo.
- Nature Sound for relaxed listening and a good night's sleep.

iPod & iPhone function (ICF-CL75iP only) (21)

- You can operate iPod or iPhone connected to the dock, and the connected iPod or iPhone will be charged automatically.
- You can enjoy iPod or iPhone music and iPod or iPhone video by connecting to this unit.

Identifying the parts

For details, see the pages indicated in parentheses.

Front

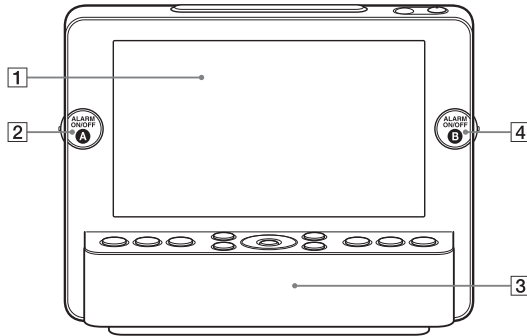

1 LCD screen

2 ALARM A ON/OFF button (16)

3 Speaker

4 ALARM B ON/OFF button (16)

Rear

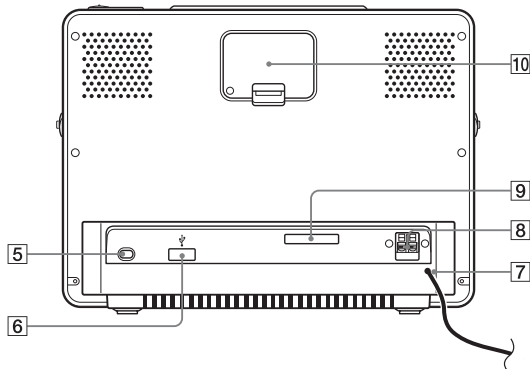

5 AC power cord (mains lead) (11)

6 USB connector (19)

7 FM wire antenna (16)

8 AM ANTENNA terminals (11)

9 PRO/SD/MMC (Multi card slot) (19, 26)

10 Battery holder (29)

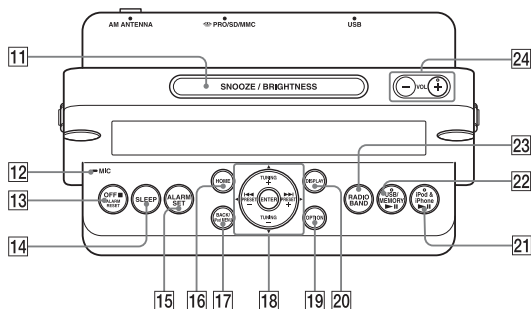

11 SNOOZE/BRIGHTNESS button (14, 17)

12 Microphone (18)

13 OFF ■ ALARM RESET button

14 SLEEP button (19)

15 ALARM SET button (16)

16 HOME button (14)

**17 BACK/iPod MENU button (ICF-CL75iP)/
BACK button (ICF-CL70)**

- Return to the previous menu screen.

18 Control button

- **ENTER:** You can select and fix menu items or setting values.
- **TUNING+/**▲** (Up):** You can set the tuning to plus and tune into a station by its frequency. You can select the relevant menu items.
- **TUNING-/**▼** (Down):** You can set the tuning to minus and tune into a station by its frequency. You can select the relevant menu items.
- **◀◀ PRESET-/**◀** (Left):** You can set the tuning to plus and tune into a station by its preset. You can select the relevant menu items. Press and hold to rewind.

- **▶▶ PRESET+/**▶** (Right):** You can set the tuning to minus and tune into a station by its preset. You can select the relevant menu items. Press and hold to fast forward.

- Operation procedure indicates with **▲/▼/◀/▶** on the control button in this manual.

19 OPTION button (14)

20 DISPLAY button (15)

**21 iPod & iPhone ▶|| button (ICF-CL75iP)/
USB/MEMORY ▶|| button (ICF-CL70)
(23)**

**22 USB/MEMORY ▶|| button (ICF-
CL75iP)/BAND button (ICF-CL70) (21)**

**23 RADIO BAND button (ICF-CL75iP)/
RADIO button (ICF-CL70) (15)**

24 VOL+/VOL- button (14)

Note

- The iPod & iPhone ▶|| button (ICF-CL75iP)/ USB/MEMORY ▶|| button (ICF-CL70) **21**, the USB/MEMORY ▶|| button (ICF-CL75iP) **22** and the VOL+ button **24** have a tactile dot.

Side

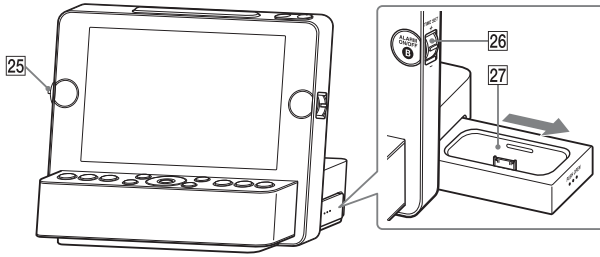

25 TIME SET A lever (16)

26 TIME SET B lever (16)

27 Docking tray for iPod & iPhone (22)
(ICF-CL75iP only)

Screen indicators



1 Alarm A/Alarm B indicator (16)

2 Date (13)

3 Time (13)

• Time is always displayed.

4 SLEEP timer indicator (19)

5 Status bar

• Displays the file name, the source, and elapsed time of the music or movie playing.

• Memory icon indicates as follows:

 : Internal memory

 : Memory card

 : USB device

 : iPod (ICF-CL75iP only)

Getting started

Checking the supplied items

Make sure that the following items are supplied:

- FM/AM Clock Radio (1)
- AM loop antenna (1)
- Operating Instructions (this manual) (1)
- Warranty (1) (In some countries or regions, the warranty is not supplied.)
- Universal dock adaptor for iPhone (1) / iPhone 3G (1) (ICF-CL75iP only)
- Sony CR2032 lithium battery (1) (In some countries or regions, the lithium battery is already set in the unit.)

Connecting the AM antenna and AC power cord (mains lead)

1 Remove only the loop part from the plastic stand.

2 Set up the AM loop antenna.

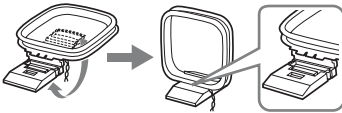

3 Connect the cords to the AM antenna terminals.

Push down and hold the terminal clamp and insert the cord.

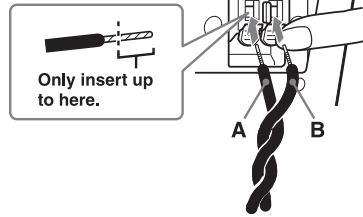

- Cord (A) or cord (B) can be connected to either terminal.

4 Make sure the AM loop antenna is connected firmly by pulling gently.

Note

- Do not place the AM loop antenna near the unit or other AV equipment, as noise may result.
- The shape and the length of the antenna is designed to receive AM signals. Do not dismantle or roll up the antenna.

Tip

- See page 16 about determining the place for the antenna and its orientation for good reception.

5 Connect the AC power cord to the wall outlet (wall socket).

- The clock screen in the default setting appears.

Note

- The unit's ATS (Automatic Time Set) function automatically keeps the correct time and never requires resetting. In some countries or regions, ATS (Automatic Time Set) function is not available.
- You can use this unit and the AC power cord (main lead) in any country or region where the power supply is within 100 V to 240 V AC, 50 Hz/60 Hz.

Tip

- You may change the time zone in some countries or regions. For details on setting the time zone, refer to "Time zone."
- Though the clock is correctly set at the factory, discrepancies may arise during transport or storage. If necessary, set the clock to the correct time by referring to "Setting the clock."
- For details on setting language, refer to "General Settings" (24).

To deactivate the Demo mode

When you connect the power cord to a wall outlet (wall socket), the demo mode will start automatically 5 seconds later.

If you want to deactivate the demo mode, press the HOME button to select [General Settings], then select [Video Setting], [Demo mode] and [OFF].

Note

- If you do not operate the unit for about 1 minute, the demo mode will start automatically, except when playing back music and video.

Setting the clock

This unit automatically sets the date and time. If this unit is initialized, you will need to set the clock manually.

- 1 Press the HOME* button.**
- 2 Select [Clock Settings] and press the ENTER button.**
- 3 Select each of the settings as follows:**

■ Time zone

Set your local area with ▲/▼.

For the USA and Canada

Atlantic Standard Time
Eastern Standard Time*
Central Standard Time
Mountain Standard Time
Pacific Standard Time
Yukon Standard Time
Hawaiian Standard Time

For Europe

Western European Time**
Central European Time*
Eastern European Time

* Factory default setting

** For the United Kingdom, the time zone is fixed.

Note

- When [Auto DST] (Auto Summer Time) is set to on, the clock advances 1 hour.
- In some countries or regions, [Time zone] is not available.

■ Auto DST (Auto Summer Time)

This unit automatically adjusts for daylight savings time (summer time) by the default setting. [☀] is displayed from the beginning of daylight savings time (summer time) and disappears at the end of daylight savings time (summer time) automatically.

Note

- In some country or region, [Auto DST] (Auto Summer Time) is not available.
- Displayed menu item differs depending on the country or region.
- You can be set [Auto DST] (Auto Summer Time) manually as necessary. Customers living in a country or region that does not use daylight savings time (summer time) must cancel [Auto DST] (Auto Summer Time) before using the unit.

■ Date/Time

Adjust the date and time display manually with

▲/▼/◀/▶.

- ◀/▶: Select the date and time.
- ▲/▼: Adjust the date and time.

Note

- This unit displays “Year/Month/Date” and 12H time format in the USA, Canada and the United Kingdom, and “Date/Month/Year” and 24H time format in Europe.

Tip

- You can set the range of year from 2009 to 2099.

4 Press the ENTER button.

- The desired settings are made.

Using this unit

Basic operations

This section describes basic operations of the unit.

Home and Option menu

Using the Home menu

You can perform the various functions, such as playing music, changing a settings, etc., easily by pressing the HOME button.

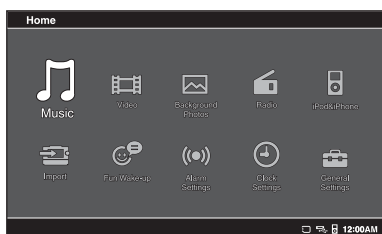

■ Home menu list

For details, see the pages indicated in parentheses.

Music	(20)
Video	(20)
Background Photos	(20)
Radio	(15)
iPod & iPhone*	(21)
Import	(19)
Fun Wake-up	(18)
Alarm Settings	(16)
Clock Settings	(12)
General Settings	(24)

* [iPod & iPhone] is available on ICF-CL75iP only.

Using the Option menu

This function is useful for changing the current setting easily while using any function by pressing the OPTION button.

■ Option menu list

Set preset/Delete preset	(15)
Select background photo	(21)
Begin slide show/Stop slide show	(21)
Select music	(20)
Select video	(20)
Set current device to Alarm (A/B)	(17)

Adjusting the volume

You can adjust the volume level from 0 to 30 using the VOL+ or VOL- buttons.

Adjusting the brightness

The brightness level is changed by pressing the SNOOZE/BRIGHTNESS button repeatedly.

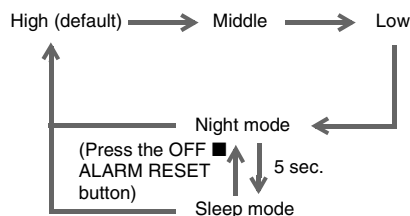

Tip

- When night mode is set with no operation on this unit, the night mode is switches to the sleep mode 5 seconds later. If you want to return the clock screen, press the SNOOZE/BRIGHTNESS button (High brightness) or press the OFF ■ ALARM RESET button (Night brightness).
- When the sleep mode is activated, the current photo disappears and the background photo (wallpaper) is black.

Changing the clock display type

The clock display has four variations. You can select the clock screen, the clock and photo screen, the photo frame, or the music or radio player screen.

- 1 Press the **DISPLAY** button repeatedly.
 - Changes the clock display type cycles as shown below.

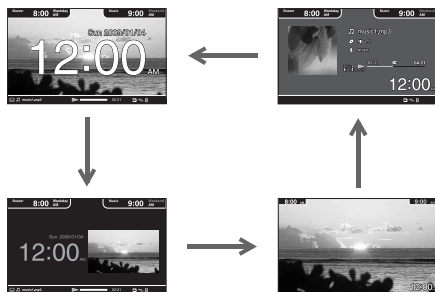

Note

- You can select the music or radio player screen display type, while playing the radio or music.

Listening to the radio

- 1 Press the **RADIO BAND** button (ICF-CL75iP) or the **RADIO** button (ICF-CL70) to turn on the radio.
 - Displays the radio screen.
- 2 Press the **RADIO BAND** button (ICF-CL75iP) or the **BAND** button (ICF-CL70) and select the **FM/AM** band.
- 3 Select a frequency with **▲/▼**.
- 4 To turn off the radio, press the **OFF** **■** **ALARM RESET** button.
 - Returns to the clock screen.

Note

- Radio frequency range differs depending on the country or region. Make sure to match your current location before using the radio. For details on the frequency range, refer to “Specifications” (31).

Presetting a station

- 1 Follow steps 1 to 3 in “Listening to the radio” above to select the desired radio station.
- 2 Press the **OPTION** button and select **[Set preset]**.
 - Confirmation screen appears, the station is stored into the new preset.

Note

- This unit stores stations in the order they are preset.
- The radio presetting data will not be lost by disconnecting the AC power supply.

Tip

- **▲** : Scans upward through the frequency bands.
- **▼** : Scans downwards through the frequency bands.
- Scanning starts from the currently tuned frequency. When the frequency is received, scanning stops.
- To search for a preset number, you press **◀/▶** until the desired preset number appears.
- You can preset 20 FM stations and 10 AM stations manually.
- If the preset number becomes full, delete the unnecessary preset.

Deleting a preset

- 1 Select the desired preset number with **◀/▶**.
- 2 Press the **OPTION** button and select **[Delete preset]**.
 - Confirmation screen appears, the selected preset is deleted.

Improving the reception

FM: Extend the FM wire antenna fully to increase reception sensitivity.

AM: Connect the supplied AM loop antenna to the unit. Rotate the antenna horizontally for optimum reception.

Note

- Keep digital music players or mobile phones away from the AM loop antenna or the FM antenna, as this may lead to reception interference.
- When you are listening to the radio with iPod connected to the unit or while charging iPod, interference with radio reception may occur (ICF-CL75iP only).

Tip

- If the FM radio is noisy, press the **HOME** button to select **[General Settings]**, then select **[Radio Setting]** and **[Mono]**. The radio becomes clearer although the sound becomes monaural.

Using the timer function

The dual alarm function allows you to use two individually set alarms. For each alarm, you can set a favorite sound, or use an originally recorded sound with a selected photo display.

Setting an alarm

- 1 Press the **ALARM SET** button.
 - Displays **[Alarm Settings]** screen.
- 2 Select **[Alarm A]** or **[Alarm B]** and press the **ENTER** button.
- 3 Set each of the settings as follows:

Note

- You can also press the **HOME** button to select **[Alarm Settings]**.

■ Alarm A/Alarm B

Turn the alarm **[ON]** or **[OFF]*** with **▲/▼**.

* Factory default setting

Note

- You can also turn the alarm on or off by pressing the **ALARM A ON/OFF** or **ALARM B ON/OFF** button.

■ Alarm Time

Set the alarm time with **▲/▼/◀/▶**.

Note

- You can also change the alarm time setting by turning the **TIME SET A** or **TIME SET B** lever.

Tip

- To increase or decrease the alarm time, push the lever up or down to increase or decrease the alarm time by 1 minute-increments. If you continuously hold the lever, the alarm time increases or decreases by 10 minute-increments.

■ Alarm Sound

Select your favorite alarm sound with ▲/▼. This unit is equipped with 7 alarm modes listed below.

FM Radio	Sets the preset FM station.
AM Radio	Sets the preset AM station.
Buzzer	Sets the buzzer.
Music	Sets the desired music.
Nature Sound*	Sets 5 types of nature sounds pre-installed in the internal memory on this unit.
iPod**	Sets the iPod music.
Fun Wake-up	Sets your original voice and photo (18).

* Factory default setting

** [iPod] is available on ICF-CL75iP only.

Tip

- To set the current sound, press the OPTION button to select [Set current device to Alarm (A)] or [Set current device to Alarm (B)].

■ Alarm Volume

Adjust the volume level from 0 to 30 with ▲/▼. The factory default setting is set to 8.

Note

- You cannot adjust the volume for buzzer.

■ Alarm Date

Select the alarm date with ▲/▼.

Everyday	Alarm sounds everyday.
Weekday*	Alarm sounds Monday to Friday.
Weekend	Alarm sounds Saturday or Sunday.

* Factory default setting

4 Press the ENTER button.

- The desired settings are made.

Deactivating the alarm setting

Press the OFF ■ ALARM RESET button to deactivate the alarm. The alarm will sound again at the same time the next day.

Note

- When the alarm sounds, the original alarm screen appears except [Fun Wake-up] alarm screen.
- For details on what to do in the event of a power interruption, see page 30.
- If an alarm time comes while files are being transferred, the alarm will sound after the transfer is finished.

Using the snooze function

You can doze for a few more minutes by using the snooze function. Each time you can change the snooze time by pressing the SNOOZE/ BRIGHTNESS button.



Note

- The maximum snooze time is 60 minutes.





Tip

- To stop the snooze function, press the OFF ■ ALARM RESET button.

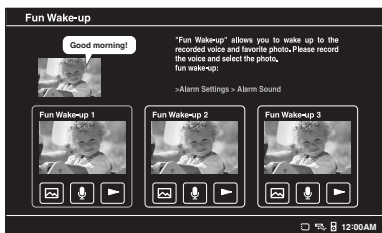



Fun Wake-up

You can wake up by your original voice and a photo as an alarm. If you want to set an alarm to “Fun Wake-up”, refer to “Setting an alarm” on page 16.





- 1 Press the HOME button.
- 2 Select [Fun Wake-up].
- 3 Select the desired , ,  setting from [Fun-Wake up 1] to [Fun-Wake up 3] with /▶.
- 4 Set each of the settings as follows:



■ To select a photo

- 1 Select  and press the ENTER button.
 - Confirmation screen appears.
- 2 Select the desired media with /▶ and press the ENTER button.
- 3 Select the desired photo from the thumbnail with /▼/◀/▶ and press the ENTER button.
 - Selected photo appears in full screen.
- 4 Select the desired photo by pressing /▶ and press the ENTER button.
 - Confirmation screen appears.
- 5 Select [Yes] with /▶ and press the ENTER button.
 - The selected photo is set as the background photo (wallpaper).

■ To record voice

- 1 Select  and press the ENTER button.
 - Confirmation screen appears.
- 2 Select [Yes] with /▶ and press the ENTER button.
 - When recording starts, record into the microphone.

Note

- Maximum recording time is 10 seconds. If you want to stop during recording, select .
- If you want to confirm the recorded voice, select  and press the ENTER button.

Using the sleep timer

You can easily set the sleep timer by pressing the SLEEP button repeatedly.

Each time you press the SLEEP button, the duration (in minutes) changes as follows:

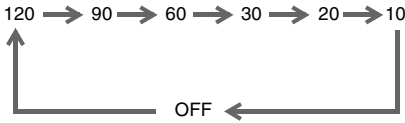

Tip

- [SLEEP] appears on the screen when the sleep timer is set.

Nature Sound for a good night's sleep

Pre-installed nature sound gives you relaxation and a good night's sleep.

- 1** Press the HOME button.
- 2** Select [Music] and press the ENTER button.
- 3** Select [Internal memory] and press the ENTER button.
- 4** Select the desired nature sound files and press the SLEEP button.

Enjoying music, video and photos

Importing files

- 1** Insert a memory card firmly into the slot with its label side facing toward you or connect a USB device to the rear of this unit.

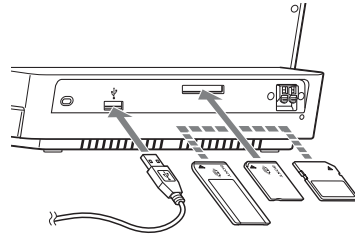

- 2** Press the HOME button.
- 3** Select [Import] and press the ENTER button.
- 4** Select the desired media and press the ENTER button.
- 5** Check the desired multiple files with ▲/▼ and press the ENTER button. Then press ►, to select [Import].
 - Confirmation screen appears.
- 6** Select [Yes] with ◀/▶ and press the ENTER button.
 - Copying of the selected files to the internal memory starts.

Note

- For details on memory cards you can use with this unit, see “About the memory cards” (26).
- Do not disconnect the AC power cord (mains lead) from the wall outlet (wall socket) during the operation. The file may be damaged.
- Remove a memory card from the slot or disconnect the USB device from the USB connector in the opposite direction from which it was inserted.

Deleting files

- 1 Press the HOME button.**
- 2 Select [General Settings] and select [Delete files], then press the ENTER button.**
- 3 Select the internal memory and press the ENTER button.**
- 4 Check the desired multiple files with ▲/▼ and press the ENTER button. Then press ► to select [Delete].**
 - Confirmation screen appears.
- 5 Select [Yes] with ◀/▶ and press the ENTER button.**
 - The selected files are deleted from the internal memory.

Note

- This unit cannot use data that has been encrypted or compressed using, for instance, fingerprint authentication or a password.
- Refer also to the connected device’s manual.
- Compatibility with all external devices are not guaranteed.
- While playing or pausing music or video, you cannot copy or delete files.

Playing back music, video and setting the background photo (wallpaper)

- 1 Press the HOME button.**
- 2 Select [Music] or [Video] and [Background Photos] and press the ENTER button.**
- 3 Select the desired media and press the ENTER button.**
- 4 Select the desired file and press the ENTER button.**
 - Plays the selected file for music and video.

Tip

- You can also play directly music or video by pressing the USB/MEMORY ►|| button.
 - To set the background photo (wallpaper) as follows:
- 5 Select the desired photo and press the ENTER button.**
 - Confirmation screen appears.

Tip

- You can display the next or previous photo by pressing ◀/▶.
- To change the music or video, press the OPTION button to bring up [Option] menu, then select [Select music] or [Select video].
- For details on changing each setting of music, video and photo, refer to “General Settings” (24).

- 6 Select [Yes] with ◀/▶ and press the ENTER button.**
 - The selected photo is set as the background photo (wallpaper).

Note

- Check supported file formats beforehand, refer to “Specifications” on page 31.
- You cannot display the cover photo for WMA content.
- Photos are used only for the background photo (wallpaper). The background photo cannot be played back.

Tip

- To change the background photo (wallpaper), press the OPTION button to bring up [Option] menu, then [Select background photo].
- You can select from 6 pre-installed photographs in the internal memory as wallpaper.

Setting the slideshow

Photos in the desired media are automatically displayed one after another.

- 1 Press the OPTION button.**
- 2 Select [Begin slide show].**
- 3 Press the ENTER button.**
 - The slideshow starts with the selected media.

Note

- The factory default setting is 10 seconds for the slideshow interval. If you want to change the interval, see page 24.

Other operations for playing, music and video

Play/Pause	Press the USB/MEMORY ► button.
Restart	Press the USB/MEMORY ► button.
Skip to previous/ the next	Press ► / ◀◀.
Fast forward/ rewind	Press and hold ► / ◀◀.
Stop	Press the OFF ■ ALARM RESET button.

Using iPod & iPhone functions (For ICF-CL75iP only)

You can enjoy music, etc., from iPod by connected to this unit. To use iPod, refer to the user’s guide of your iPod.

Compatible iPod models

Compatible iPod models are as follows. Update your iPod to use the latest software beforehand.



iPod touch 2nd generation



iPod nano 4th generation (video)



iPhone 3G

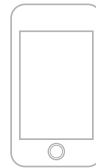

iPod touch 1st generation



iPod nano 3rd generation (video)



iPod classic



iPhone



iPod nano 2nd generation (aluminum)



iPod 5th generation (video)



iPod nano 1st generation



iPod 4th generation (color display)



iPod 4th generation



iPod mini

Note

- iPod shuffle is not available on this unit.
- Sony cannot accept responsibility in the event that data recorded to iPod is lost or damaged when using iPod connected to this unit.
- iPod 4th generation (color display) cannot play photo.

Playing iPod

You can play iPod music or iPod video content by connecting to this unit. For details on iPod operation, see the user's guide of your iPod.

1 Push the PUSH OPEN.

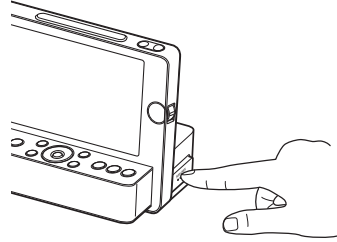

- The docking tray is ejected halfway.

2 Pull the docking tray all the way out.

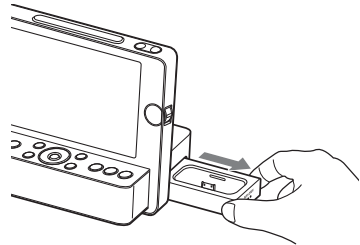

3 Attach the adapter for your iPod/iPhone.

Note

Universal dock adapter

For iPhone



12

For iPhone 3G



15

- If you are using iPhone or iPhone 3G, attach the supplied universal dock adapter for iPhone or iPhone 3G before inserting into the connector. The adapter number, 12 or 15, is shown on the bottom-rear of the supplied universal dock adapters. 12 is for the iPhone, and 15 is for the iPhone 3G. Check the adapter number before use.

4 Insert your iPod/iPhone into the connector of the unit.

5 Press the iPod & iPhone ►|| button.

- iPod starts playing.

Note

- iPod touch/iPhone cannot play video automatically. Please manually start playing video from the iPod unit.
- You cannot display the album artwork of iPod or iPhone on this unit.

Displaying iPod photo

If you want to display iPod photo on this unit, select [Video] in [iPod & iPhone] menu while playing iPod.

Basic operation of this unit

To	Press
Stop iPod	OFF ■ ALARM RESET button
Pause playback	iPod & iPhone ► button. To resume play, press it again.
Go to the next track	►►
Go back to the previous track	◄◄
Locate a point while listening to the sound	►► or ◄◄ while playing and hold it until you find the point.
Go back to the previous menu	BACK/iPod MENU button
Select a menu item or a track for playback	▲/▼
Execute the selected menu or begin playback	ENTER button

Tip

- Another way to play iPod is by pressing the HOME button to select [iPod & iPhone].
- You can operate the menu for iPod Touch and iPhone when [Music] or [Video] is already selected.

Charging iPod

You can use the unit as an iPod battery charger. Charging begins when iPod is connected.

Setting iPod alarm

You can set an alarm sound from your iPod. For details on how to set iPod sound as the alarm, refer to “Setting an alarm” on page 16.

General Settings

- 1 Press the HOME button.
- 2 Select [General Settings] and press the ENTER button.
- 3 Select each of the settings as follows:

■ Language Setting

Select the language to be displayed with ▲/▼.

Language Setting	English*, Deutsch, Español, Français, Italiano, Português, Русский, Nederlands
------------------	--

* Factory default setting

■ Music Setting

Select the playing mode with ▲/▼.

Normal*	Plays music without repeating.
Repeat	Plays music repeatedly.
Repeat 1 Song	The current song is played repeatedly.

* Factory default setting

■ Video Setting

Change the playing back mode with ▲/▼.

Display mode***	Full screen mode	Displays an image enlarged to full screen size.**
	Fit to screen*	Zooms in on the center of the image, sufficient to fill the entire screen.**
Demo mode	ON*	Activates the demo mode.
	OFF	Deactivates the demo mode.

* Factory default setting

** The original image data will not change.

*** Display mode is not available while playing iPod/iPhone Video.

■ Photo Setting

Select the display mode for photo with ▲/▼/◀/▶.

Display mode	Full screen mode	The entire photo is displayed.
	Fit to screen*	The photo size fits in the unit screen.
Slide show	ON*	Plays the slideshow.
	OFF	Cancels the slideshow.
Slide show interval	10sec.*/1min./1hour/12hours/24hours	

* Factory default setting

■ Radio Setting

Select the radio setting with ▲/▼.

AM channel step

10kHz	For the USA and Canada
9kHz	For Europe

FM Mono/Auto

Mono	Forces the radio to play in monaural.
Auto*	Switches from stereo to monaural automatically, in response to the FM signal.

* Factory default setting

■ Reset all settings

Resets the current settings to the default settings.

■ Format

Formatting deletes all the music, video and photo files to free up space in the internal memory.

Note

- Initializing the unit may be required depending on the problem. In the event of this, the data stored on the internal memory will be deleted.
- All files imported to the internal memory will be deleted except pre-installed music and photos.
- Do not format the internal memory by connecting to other external devices.

■ Delete files

You can delete selected files in the internal memory. Refer to “Deleting files” on page 20.

■ Unit information

Display the information of this unit.

4 Press the ENTER button.

- The desired settings are made.

Troubleshooting

Should any problem persist after you have made the following checks, consult your nearest Sony dealer.

The power cannot be turned on.

- Insert the power plug properly.

Cannot hear sound from this unit.

- The volume is set too low. Turn up the volume.

The clock setting screen appears due to a power interruption.

- The battery is low. Replace the battery. Remove the old battery and install a new one.

When daylight savings time begins, the clock does not employ the daylight savings time automatically.

- Make sure the clock is set correctly.

The alarm settings do not sound at the preset alarm time.

- Check that [Alarm A] or [Alarm B] is properly displayed.

The alarm settings are activated but there is no sounds at the preset alarm time.

- Check the alarm the volume setting.

Music file in the USB device is not played.

- The USB device is not recognized, try another USB device.

Cannot listen to the AM radio sound.

- Connect the AM loop antenna to this unit.

No photos are displayed on the screen.

- Insert a memory card or connect a USB device properly.
- Insert a memory card containing photos or connect an external device containing photos.
- Check the file formats that can be displayed.

Some images are not displayed.

- The unit can play, save, delete, or otherwise handle up to 9,999 image files.

A photo was deleted accidentally.

- A photo cannot be recovered once it is deleted.

There is no sound from iPod (ICF-CL75iP only).

- Make sure iPod is securely connected.
- Adjust the volume.

iPod cannot be operated with this unit (ICF-CL75iP only).

- Make sure iPod is securely connected.
-

iPod cannot be charged (ICF-CL75iP only).

- Make sure iPod is securely connected.
-

About the memory cards

“Memory Stick” media

“Memory Stick” media are a compact, portable IC recording medium with a large data capacity. The types of “Memory Stick Duo” media that can be used with the clock radio are listed in the table below.

Types of “Memory Stick” media that the clock radio can use

With the clock radio, you can use the following types of “Memory Stick” media ^{*1}:

Type of “Memory Stick” media	Playback
“Memory Stick” ^{*2} (Not compatible with “MagicGate”)	○
“Memory Stick” ^{*2} (Compatible with “MagicGate”)	○
“MagicGate Memory Stick” ^{*5}	○
“Memory Stick PRO” ^{*2}	○
“Memory Stick PRO DUO”	○
“Memory Stick PRO-HG”	–
“Memory Stick Micro” ^{*3} (“M2” ^{*4})	○

^{*1}) The clock radio supports FAT32. The clock radio has been demonstrated as operable with a “Memory Stick” media with a capacity of 32 GB or less manufactured by Sony Corporation. However, we do not guarantee the operations of all the “Memory Stick” media.

^{*2}) The clock radio is equipped with a slot compatible with both standard-size and Duo-size media. Without a “Memory Stick Duo” media adaptor, you can use both a standard-size “Memory Stick” media and the compact-size “Memory Stick Duo” media.

- *3) When using a “Memory Stick Micro” media with the clock radio, always insert it into an M2 adaptor.
- *4) “M2” is an abbreviation for “Memory Stick Micro” media. In this section, “M2” is used to describe “Memory Stick Micro” media.
- *5) Data reading/recording that requires “MagicGate” copyright protection cannot be performed. “MagicGate” is the general name of a copyright protection technology developed by Sony using authentication and encryption.
 - The clock radio does not support 8 bit parallel data transfer.

Notes on use

- For the latest information on the “Memory Stick” media types that the clock radio supports, see the “Memory Stick” media compatibility information on the Sony web site:
<http://www.memorystick.com/en/support/compatible.html>
- Do not insert more than one “Memory Stick” media at the same time, which may cause trouble with the clock radio.
- If you use a “Memory Stick Micro” media with the clock radio, “Memory Stick Micro” media needs to be inserted into an “M2” adaptor.
- If you insert a “Memory Stick Micro” media into the clock radio without an “M2” adaptor, you may be unable to remove the “Memory Stick Micro” media.

- If you insert a “Memory Stick Micro” media into an “M2” adaptor, and insert the “M2” adaptor into a “Memory Stick Duo” media adaptor, the clock radio may not operate properly.
- When you format a “Memory Stick” media, use the format function of your clock radio. If you format a “Memory Stick” media with your computer, images may not be displayed properly.
- When you format a “Memory Stick” media, all the data including protected image files will be erased. To avoid erasing important data by accident, make sure to check the contents of the “Memory Stick” media before formatting.
- You cannot record, edit or delete data if you slide the write-protect switch to LOCK.

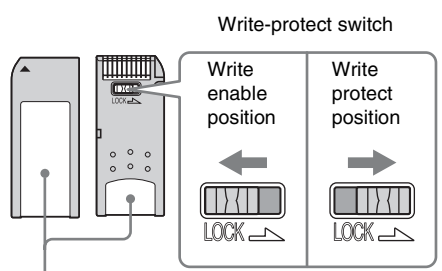

Place the label here.

- Do not attach any other material than the supplied label on the labelling position. When you attach the supplied label, be sure to attach it to the labelling position. Be careful that the label does not stick out.

SD memory card

The SD memory card slot of the clock radio allows you to use the following:

- SD memory card^{*1}
- miniSD card, microSD card
(An adaptor is necessary.)^{*2}
- SDHC memory card^{*3}
- MMC standard memory card^{*4}

We do not guarantee proper operations for all types of SD memory cards and MMC standard memory cards.

^{*1)} The clock radio has been demonstrated as operable with an SD memory card with a capacity of 2 GB or smaller.

^{*2)} Some commercially available card adaptors have projected terminals on the rear. This type of adaptor may not work properly with the clock radio.

^{*3)} The clock radio has been demonstrated as operable with an SDHC memory card with a capacity of 8 GB or less.

^{*4)} The clock radio has been demonstrated as operable with an MMC standard memory card with a capacity of 2 GB or less.

Notes on use

Data reading that requires copyright protection cannot be performed.

Notes on using a memory card

- When using a card, make sure to check the correct insertion direction of the card and the correct insertion slot.
- When inserting the memory card, it will only insert the portion of the way, so do not try to force it as this could damage the memory card and/or clock radio.
- Do not remove a card while the clock radio is reading or writing data. Otherwise, data may be rendered unreadable or erased.
- We recommend that you save a backup of important data.
- Data processed with the computer may not be displayed with the clock radio.
- When you carry or store a card, put it in the case supplied with it.
- Do not touch the terminal of a card with your hand or a metal object.
- Do not strike, bends or drop a card.
- Do not disassemble or modify a card.
- Do not expose a card to water.
- Do not use or store a card under the following conditions:
 - Locations beyond the required operational conditions including locations such as the hot interior of a car parked in the sun and/or in the summer, the outdoors exposed to direct sunlight, or a place near a heater.
 - Humid locations or locations with corrosive substances present
 - Locations subject to static electricity or electrical noises

Precautions

- Play the unit on the power source specified in “Specifications.”
- To disconnect the AC power cord (mains lead), pull it out by the plug, not the cord.
- Since a strong magnet is used for the speaker, keep personal credit cards using magnetic coding or spring-wound watches away from the unit to prevent possible damage from the magnet.
- Do not leave the unit in a location near a heat source such as a radiator or airduct, or in a place subject to direct sunlight, excessive dust, mechanical vibration, or shock.
- Allow adequate air circulation to prevent internal heat build-up. Do not place the unit on a surface (a rug, a blanket, etc.) or near materials (a curtain) which might block the ventilation holes.
- Should any solid object or liquid fall into the unit, unplug the unit and have it checked by qualified personnel before operating it any further.
- To clean the casing, use a soft cloth dampened with a mild detergent solution.
- Never touch the wire of the external FM antenna during a thunderstorm. Furthermore, immediately disconnect the AC power cord (mains lead) from the radio.

If you have any questions or problems concerning your unit, please consult your nearest Sony dealer.

Replacing the battery

- 1** Keep the AC plug connected to the wall outlet (wall socket), remove the screw that secures the battery holder at the back of the unit using a screwdriver.
- 2** Open the battery holder.
- 3** Replace a new battery in the battery holder with the + side facing up.
- 4** Close the battery holder and secure it with the screw.

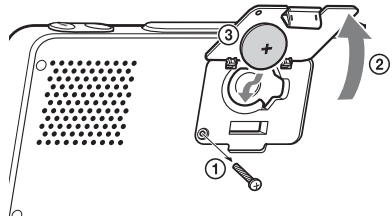



- 5** Press the HOME button and the DISPLAY button at the same time in [Home] menu screen to turn  off on the screen.

Note

- When you replace the battery, do not disconnect the plug from the wall outlet (wall socket). Otherwise, the calendar, current time, alarm and station presets will be initialized.

Note on the alarm in the event of a power interruption

In the event of a power interruption, the alarm will work until the battery is totally discharged. However, certain functions will be affected as follows:

- The backlight will not light up.
- If the alarm mode is set to any mode other than buzzer, it will change to buzzer automatically.
- If a power interruption occurs while the alarm is sounding, the alarm will stop.
- If the alarm is not stopped, the alarm will sound for about 5 minutes.
- If “” appears in the display, the alarm will not sound in the event of power interruption. Replace the battery if “” appears.
- The snooze function will not work.
- During a power interruption, the alarm will sound at the set time only once.

Note

- To keep accurate time, this unit contains a CR2032 battery inside of the unit as a backup power source. If a power interruption occurs while the battery is weak, the current time and alarm will be initialized. Replace the battery with a Sony CR2032 lithium battery. Use of another battery may cause a fire or explosion.

Note for customers in Europe (except East Europe)

The clock is preset at the factory, and its memory is powered by the preinstalled Sony CR2032 battery. If the clock setting screen appears in the display when the unit is connected to AC outlet for the first time, the battery may be weak. In this case, consult a Sony dealer. The preinstalled CR2032 battery is considered part of the product, and is covered by the warranty. You are required to show “Note for customers in Europe (except East Europe)” (in this instruction) to a Sony dealer in order to validate the warranty for this product.

NOTES ON LITHIUM BATTERY

- Wipe the battery with a dry cloth to assure a good contact.
- Be sure to observe the correct polarity when installing the battery.
- Do not hold the battery with metallic tweezers, otherwise a short circuit may occur.

On trademarks

-  “Memory Stick”, **MEMORY STICK**, “Memory Stick Duo”, **MEMORY STICK DUO**, “MagicGate Memory Stick”, “Memory Stick PRO”, **MEMORY STICK PRO**, “Memory Stick PRO Duo”, **MEMORY STICK PRO DUO**, “Memory Stick PRO-HG Duo”, **MEMORY STICK PRO-HG DUO**, “Memory Stick Micro”, **MEMORY STICK MICRO**, **M2**, “Memory Stick-ROM”, **MEMORY STICK-ROM**, “MagicGate”, and **MAGIC GATE** are trademarks or registered trademarks of Sony Corporation.
- iPod is a trademark of Apple Inc., registered in the U.S. and other countries.
- iPhone is trademark of Apple Inc.
- “Made for iPod” means that an electronic accessory has been designed to connect specifically to iPod and has been certified by the developer to meet Apple performance standards.
- “Works with iPhone” means that an electronic accessory has been designed to connect specifically to iPhone and has been certified by the developer to meet Apple performance standards.
- Apple is not responsible for the operation of this device or its compliance with safety and regulatory standards.
- MPEG Layer-3 audio decoding technology licensed from Fraunhofer IIS and Thomson Multimedia.
- Dream Machine is a trademark of Sony Corporation.
- No Power No Problem is a trademark of Sony Corporation.
- All other companies and product names mentioned herein may be the trademarks or registered trademarks of their respective companies. Furthermore, “™” and “®” are not mentioned in each case in this manual.

Specifications

■ Radio section

Frequency range:

For USA and Canada

FM: 87.5 - 108 MHz (0.1 MHz Channel step)

AM: 530 - 1710 kHz (10 kHz Channel step)

For Europe

FM: 87.5 - 108 MHz (0.05 MHz Channel step)

AM: 531 - 1602 kHz (9 kHz Channel step)

Station Preset(s): 20 FM, 10 AM

■ Alarm section

Alarm numbers: Dual

Weekend Alarm: Every day/Work day/Week end

Snooze: 10 minutes intervals up to 1 Hour

Fun Wake up (Wake up Photo and recording voice): Numbers: 3

Maximum recording time: 10 sec.

■ iPod section (for ICF-CL75iP only)

DC out: 5 V

MAX: 500 mA

■ General

LCD Size: 7 inch/WVGA (800 × 480)

Brightness: 4 steps (Hi, Mid, Lo, Night mode)

Speaker: \varnothing 31.3 mm (1.2 inches) × 2

Rated impedance 8 Ω

Memory slot: Multi card slot (MS, MS PRO, MS Duo, MS PRO Duo, SD, SDHC, MMC)/USB

Internal memory size (User area): 1 GB (902 MB)

Audio:

MP3

Bit rate: 32 - 320 kbps (VBR-compatible)

Sampling rate: 8 - 48 kHz

WMA^{*1*2}

Bit rate: 32 - 192 kbps

Sampling rate: 8 - 48 kHz

*1) Support version 7.0, 8.0

*2) Files with copyright protection cannot be played by this unit.

Photo: JPEG (Maximum size: 4,096 × 4,096)

Slide show: 10 sec./1 min./1 hour/12 hours/24 hours

Video Compression Format:

MPEG-1

File Format: MP4 File Format, AVI File Format

Extension: .mpg, .avi

Bit rate: Max. 4 Mbps

Frame rate: Max. 30 fps

Resolution: Max. 720 × 576

MPEG-4

File Format: MP4 File Format, AVI File Format

Extension: .mp4, .avi

Profile: Advanced Simple Profile

Bit rate: Max. 4 Mbps

Frame rate: Max. 30 fps

Resolution: Max. 720 × 576

Motion-JPEG

Format: Quick Time Format, AVI Format

Extension: .mov, .avi

Resolution: Max. 640 × 480

Audio Compression Format:

AAC-LC (For MP4, AVI file format)

Channel: Max. 2 ch

Sampling rate: 24, 32, 44.1, 48 kHz

MPEG-3 (For AVI file format)

Channel: Max. 2 ch

Sampling rate: 24, 32, 44.1, 48 kHz

PCM (For MPEG-1)

Channel: Max. 2 ch

Sampling rate: 24, 32, 44.1, 48 kHz

Sleep: 10 min./20 min./30 min./60 min./90 min./120 min.

Nature sound: Sea Waves, Birds, Rain, Brook, Under the Sea

Power output: 1 W + 1 W (at 10% harmonic distortion)

Power requirements:

For USA and Canada: 120 V AC, 60 Hz

For Europe: 230 V AC, 50 Hz

Power consumption: 18 W (Brightness Hi)

Back up battery: CR2032

Dimensions (Approx.): 205.6 × 148 × 119.5

mm (8 1/8 × 5 7/8 × 4 3/4 inches) (w/h/d)

(not including projecting parts and controls)

Mass (Approx.): 976 g (2 lb 2.4 oz) (including power supply unit)

Check the supplied items on page 11.

SONY®

Portable Audio

LIMITED WARRANTY (U.S. Only)

Sony Electronics Inc. ("Sony") warrants this product against defects in material or workmanship for the time periods and as set forth below. Pursuant to this Limited Warranty, Sony will, at its option, (i) repair the product using new or refurbished parts or (ii) replace the product with a new or refurbished product. For purposes of this Limited Warranty, "refurbished" means a product or part that has been returned to its original specifications. **In the event of a defect, these are your exclusive remedies.**

Labor: For a period of one (1) year from the original date of purchase of the product ("Labor Warranty"), Sony will, at its option, repair or replace with new or refurbished product, product determined to be defective. If Sony elects to replace the product after this Labor Warranty has expired but while the Parts Warranty below is still in effect, it will do so for the applicable labor charge.

Parts: For a period of one (1) year from the original date of purchase of product ("Parts Warranty"), Sony will supply new or refurbished replacement parts in exchange for parts determined to be defective.

This Limited Warranty covers only the hardware components packaged with the Product. It does not cover technical assistance for hardware or software usage and it does not cover any software products whether or not contained in the Product; any such software is provided "AS IS" unless expressly provided for in any enclosed software Limited Warranty. Please refer to the End User License Agreements included with the Product for your rights and obligations with respect to the software.

Instructions: To obtain warranty service, you must deliver the product, freight prepaid, in either its original packaging or packaging affording an equal degree of protection to the Sony authorized service facility specified. **It is your responsibility to backup any data, software or other materials you may have stored or preserved on your unit. It is likely that such data, software, or other materials will be lost or reformatted during service and Sony will not be responsible for any such damage or loss.** A dated purchase receipt is required. For specific instructions on how to obtain warranty service for your product,

Visit Sony's Web Site:
www.sony.com/service

Or call the **Sony Customer Information Service Center**
1-800-222-SONY (7669)

For an accessory or part not available from your authorized dealer, call:

1-800-488-SONY (7669)

Repair / Replacement Warranty: This Limited Warranty shall apply to any repair, replacement part or replacement product for the remainder of the original Limited Warranty period or for ninety (90) days, whichever is longer. Any parts or product replaced under this Limited Warranty will become the property of Sony.

This Limited Warranty only covers product issues caused by defects in material or workmanship during ordinary consumer use; it does not cover product issues caused by any other reason, including but not limited to product issues due to commercial use, acts of God, misuse, limitations of technology, or modification of or to any part of the Sony product. This Limited Warranty does not cover Sony products sold AS IS or WITH ALL FAULTS or consumables (such as fuses or batteries). This Limited Warranty is invalid if the factory-applied serial number has been altered or removed from the product. This Limited Warranty is valid only in the United States.

LIMITATION ON DAMAGES: SONY SHALL NOT BE LIABLE FOR ANY INCIDENTAL OR CONSEQUENTIAL DAMAGES FOR BREACH OF ANY EXPRESS OR IMPLIED WARRANTY ON THIS PRODUCT.

DURATION OF IMPLIED WARRANTIES: EXCEPT TO THE EXTENT PROHIBITED BY APPLICABLE LAW, ANY IMPLIED WARRANTY OF MERCHANTABILITY OR FITNESS FOR A PARTICULAR PURPOSE ON THIS PRODUCT IS LIMITED IN DURATION TO THE DURATION OF THIS WARRANTY.

Some states do not allow the exclusion or limitation of incidental or consequential damages, or allow limitations on how long an implied warranty lasts, so the above limitations or exclusions may not apply to you. This Limited Warranty gives you specific legal rights and you may have other rights which vary from state to state.

D455714503

This unit includes a preinstalled Sony Lithium battery (CR2032) as back-up power source for the clock, which is preset to EST (Eastern Standard Time) at the factory. And this battery is considered part of the product.



* 4 1 5 4 5 8 4 1 1 * (2)