

# KENWOOD

CD-RECEIVER

## KDC-X994 KDC-BT945U KDC-X794 KDC-MP745U

### INSTRUCTION MANUAL

Kenwood Corporation

The latest version of the Instruction Manual can be downloaded from [www.kenwood.com/cs/ce/](http://www.kenwood.com/cs/ce/). Before reading this manual, please access this site to check whether your manual is the latest one.



**Take the time to read through this instruction manual.**

**Familiarity with installation and operation procedures will help you obtain the best performance from your new CD-receiver.**

**For your records**

Record the serial number, found on the back of the unit, in the spaces designated on the warranty card, and in the space provided below. Refer to the model and serial numbers whenever you call upon your Kenwood dealer for information or service on the product.

Model KDC-X994/ KDC-BT945U/ KDC-X794/ KDC-MP745U Serial number \_\_\_\_\_

**US Residents Only**

**Register Online**

Register your Kenwood product at [www.Kenwoodusa.com](http://www.Kenwoodusa.com)

# Contents

<b>Before use</b>	<b>4</b>	<b>Bluetooth Audio Operation</b>	<b>23</b>
<b>Component names and functions</b>	<b>6</b>	Connecting a Bluetooth Device Basic Operation	
<b>General operation</b>	<b>7</b>	<b>Operation of hands-free phoning</b>	<b>24</b>
Before Using Common Operation Menu List Operation		Connecting a Bluetooth Device Receiving a Call During a Call Call Waiting Other Functions Making a Call Speed Dialing (Preset Dial) Calling a Number in the Phone Book Calling a Number in the Call log Dial a Number Make a Voice Dialing Call Registering to the Preset Dial Number List Display of Phone Number type (category)	
<b>iPod/iPhone Operation</b>	<b>8</b>	<b>Display Settings</b>	<b>28</b>
Basic Operation Selecting a song by browsing iPod Play Mode iPod Setting Selecting the Search mode Direct Search Related Search Alphabet Search Skip Search My Playlist		Basic Operation Display Setting Customization of 5-line Display Mode & 3-line Display Mode & iPod-like Display Mode Customization of Spectrum Analyzer Display Mode Illumination Color Selection Auxiliary Input Display Setting	
<b>USB device Operation</b>	<b>14</b>	<b>Clock and Other Functions</b>	<b>34</b>
Basic Operation File Search Play Mode USB Setting Skip Search Direct Music Search		Clock and Date Adjustment Initial Settings Demonstration mode Setting Muting volume upon reception of Phone call Theft Deterrent Faceplate	
<b>Music CD/ Audio file Operation</b>	<b>17</b>	<b>Audio Adjustments</b>	<b>38</b>
Basic Operation Music Search Play Mode Basic Operation of Disc Changer (Optional) Direct Music Search Direct Disc Search		Audio Control Preset Equalizer curve Select Manual Equalizer Control Listening Position Selection Listening Position Fine Adjustments Dual Zone System	
<b>Tuner Operation</b>	<b>20</b>		
Basic Operation Tuner Setting Station Preset Memory Auto Memory Entry Preset Tuning Direct Access Tuning PTY (Program Type) Program Type Preset			

<b>DSP Setup</b>	<b>42</b>	<b>Basic Operations of remote control</b>	<b>60</b>
Car Type Selection		<b>Appendix</b>	<b>62</b>
Speaker Setting		About Audio file	
Car Type Fine Adjustments		iPod/iPhone that can be connected to this unit	
X'Over Setting		About USB device	
Audio Preset Memory		About "KENWOOD Music Editor"	
Audio Preset Recall		About the Cell-Phone	
<b>Favorite Control</b>	<b>46</b>	About the Bluetooth Audio player	
Favorite Preset Memory		About Satellite Radio tuner (Optional)	
Favorite Preset Recall		About HD Radio Reception (Optional)	
Favorite Preset Memory Delete		Menu List	
<b>Bluetooth Setup</b>	<b>48</b>	Display Indicator items	
Bluetooth Setting		<b>Accessories/ Installation Procedure</b>	<b>69</b>
Registering Bluetooth device		<b>Connecting Wires to Terminals</b>	<b>70</b>
Registering PIN Code		<b>Installation/Removing the Unit</b>	<b>71</b>
Selecting the Bluetooth device You Wish to Connect		<b>Troubleshooting Guide</b>	<b>73</b>
Deleting a Registered Bluetooth device		<b>Specifications</b>	<b>76</b>
Downloading the Phone Book			
Adding a Voice Dialing Command			
Setting a Voice Command for Category			
<b>SMS (Short Message Service)</b>	<b>54</b>		
Downloading the SMS			
SMS (Short Message Service)			
<b>Satellite Radio Tuner Control (Optional)</b>	<b>56</b>		
Basic Operation			
Satellite Radio Setting			
Category and Channel Search			
Preset Memory			
Preset Tuning			
Channel Scan			
Direct Access Tuning			
<b>HD Radio™ Tuner Control (Optional)</b>	<b>58</b>		
Basic Operation			
Station Preset Memory			
Auto Memory Entry			
Preset Tuning			
HD Radio™ Setting			
Direct Access Tuning			
iTunes Tagging			

## Before use

### ▲WARNING

#### To prevent injury or fire, take the following precautions:

To prevent a short circuit, never put or leave any metallic objects (such as coins or metal tools) inside the unit.

#### Do not use this unit before canceling Demonstration mode!

This unit is initially set on the Demonstration mode. When using this unit for the first time, cancel the Demonstration mode. Refer to <Before Using> (page 7).

#### How to reset your unit

If this unit or the connected unit (auto disc changer, etc.) fails to operate properly, press the Reset button. The unit returns to factory settings when the Reset button is pressed.

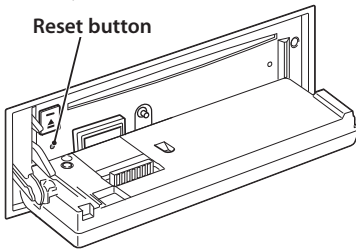

#### Cleaning the Unit

If the faceplate of this unit is stained, wipe it with a dry soft cloth such as a silicon cloth.

If the faceplate is stained badly, wipe the stain off with a cloth moistened with neutral cleaner, then wipe it again with a clean soft dry cloth.



- Applying spray cleaner directly to the unit may affect its mechanical parts. Wiping the faceplate with a hard cloth or using a volatile liquid such as thinner or alcohol may scratch the surface or erase characters.

#### Unit and Faceplate Terminals

- To prevent deterioration, do not touch the terminals of the unit and faceplate with your fingers.
- If the terminals on the unit or faceplate get dirty, wipe them with a clean soft dry cloth.

#### Lens Fogging

When you turn on the car heater in cold weather, dew or condensation may form on the lens in the CD player of the unit. Called lens fogging, this condensation on the lens may not allow CDs to play. In such a situation, remove the disc and wait for the condensation to evaporate. If the unit still does not operate normally after a while, consult your Kenwood dealer.

#### Notes

- If you experience problems during installation, consult your Kenwood dealer.
- When you purchase optional accessories, check with your Kenwood dealer to make sure that they work with your model and in your area.
- Characters that conform to ISO 8859-1 can be displayed.
- The RDS feature won't work where the service is not supported by any broadcasting station.
- In this document, the description indicator will light means a status is displayed. Refer to <Basic Operation> (page 28) for the details of the status display.
- The illustrations of the display and the panel appearing in this manual are examples used to explain more clearly how the controls are used. Therefore, what appears on the display in the illustrations may differ from what appears on the display on the actual equipment, and some of the illustrations on the display may be inapplicable.

## Handling CDs

- Do not touch the recording surface of the CD.
- Do not stick tape etc. on the CD, or use a CD with tape stuck on it.
- Do not use disc type accessories.
- Clean from the center of the disc and move outward.
- When removing CDs from this unit, pull them out horizontally.
- If the CD center hole or outside rim has burrs, use the CD only after removing the burrs with a ballpoint pen etc.

## CDs that cannot be used

- CDs that are not round cannot be used.

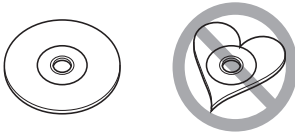

- CDs with coloring on the recording surface or CDs that are dirty cannot be used.
- This unit can only play the CDs with .  
This unit may not correctly play discs which do not have the mark.
- You cannot play a CD-R or CD-RW that has not been finalized. (For the finalization process refer to your CD-R/CD-RW writing software, and your CD-R/CD-RW recorder instruction manual.)
- 3 inch CD cannot be used. Attempt to insert using an adapter can cause malfunction.

## Component names and functions

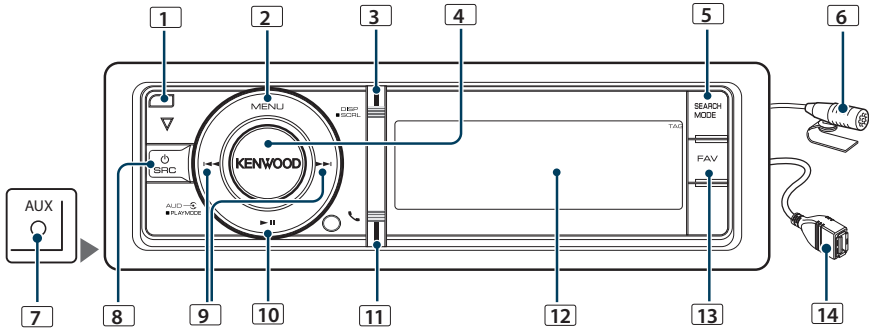

### 1 Release button

To drop the faceplate down to open and CD can be inserted or ejected (press the button).

### 2 [MENU] button

To select a song or set functions. See [<Menu List Operation>](#) (page 7).

### 3 [DISP] button

To change display item (press the button).

### 4 [VOL] knob

To adjust volume (turn the knob).

To select menu list item (turn and press the knob). See [<Menu List Operation>](#) (page 7) for details.

KDC-X994/KDC-BT945U : Enters Play mode Menu

(press the button at least 1 second).

KDC-X794/KDC-MP745U : To make a voice dialing call (press the button at least 1 second).

### 5 [SEARCH MODE] button

To enter Search mode (iPod), move between folders (Audio file), etc. For more details, see operations of each source described in page 8 or later.

### 6 Microphone (KDC-X994/ KDC-BT945U)

The microphone for the hands free phone is supplied.

When your voice cannot be recognized due to the low microphone volume or noises in the vehicle, adjust the microphone settings by [<Bluetooth Setting>](#) (page 48).

### 7 Auxiliary Input Terminal

Portable audio device can be connected with the mini-plug (3.5 mm  $\phi$ ).

- Use the mini-plug cable which is stereo type and does not have any resistance.

### 8 [SRC] button

To turn on this unit and select the Source (press the button).

To turn off this unit (press the button at least 1 second).

### 9 [◀◀] / [▶▶] buttons

To select station, song and setting items. (press the button).

### 10 [▶||] button

To start or interrupt playback for CD, audio file, and iPod (press the button).

To select the remove mode, and remove the USB device or an iPod (press the button at least 2 seconds).

### 11 [Bluetooth icon] button (KDC-X994/ KDC-BT945U)

To enter Bluetooth mode (press the button).

To make a voice dialing call (press the button at least 1 second).

### [PLAY MODE] button (KDC-X794/ KDC-MP745U)

Enters Play mode Menu (press the button).

To enter Bluetooth mode (press the button at least 1 second).

### 12 Display window

### 13 [FAV] button

To recall a registered favorite item (press the button).

To register to Favorite (press the button at least 1 second).

### 14 USB Terminal

A USB device or an iPod can be connected.

# General operation

## Before Using

### Exit of the Demonstration Mode

Turn off the demonstration mode when you use it for the first time after installation.

- 1 Press the [VOL] knob to quit the demonstration mode when the messages "To cancel Demo press the volume knob" are displayed (approx. 15 seconds).
- 2 Turn the [VOL] knob to select "YES" and press the [VOL] knob.



- Demonstration mode can also be cancelled in "DEMO Mode" of Menu List mode. Refer to <Demonstration mode Setting> (page 35).

## Common Operation

### Power and source select

Turns the power ON by pressing the [SRC] button.

When the power is ON, select a source.

- SRC Select mode 1: Press the [SRC] button and then turn the [VOL] knob. To determine the selected source, press the [VOL] knob.
- SRC Select mode 2: Pressing the [SRC] button each time switches between sources. Tuner ("TUNER" or "HD RADIO") → Bluetooth Audio ("BT AUDIO") (KDC-X994, KDC-BT945U only) → USB ("USB") or iPod ("iPod") → CD ("CD") → Auxiliary input ("AUX") → Standby ("STANDBY") → Tuner...

Keeping pressing the [SRC] button for at least 1 second turns the power OFF.



- The SRC Select mode can be set in "SRC Select" of <Initial Settings> (page 34).
- Auxiliary input source is initially set to "OFF". Set "Built in AUX" described in <Initial Settings> (page 34) to "ON".
- When an optional accessory is connected, the source name for each device appears.
- When connection of the iPod is recognized, the source display changes from "USB" to "iPod".

### Volume

Turning the [VOL] knob adjusts the sound volume.

## Menu List Operation

The basic operating procedure for using this function is described below. The individual function items are covered in the operating procedures.

### 1 Select the source

Press the [SRC] button. Turn the [VOL] knob and press it when the desired item is displayed.

Function items vary from source to source. For a list of the function items. Refer to <Menu List> (page 64).

➤ SRC Select mode 2: Pressing the [SRC] button repeatedly switches source.

### 2 Enter Menu List mode

Press the [MENU] button.

### 3 Select the setting item

Turn the [VOL] knob and press it when the desired item is displayed.

Repeat the operation until your desired setup item is selected.

➤ Press the [MENU] button to return to the previous item.

Operation example:

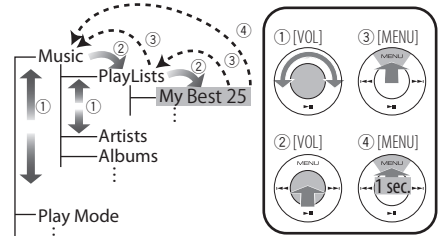

In this manual, the above selection is indicated as **Select "Music" > "Playlists" > "My Best 25"**.

### 4 Make a setting

- When the "PUSH" icon is displayed (at the right edge of the display) Turn the [VOL] knob to select a setting value, and then press the [VOL] knob.
- When the "PUSH" icon is not displayed Press the [◀] or [▶] button to select a setting value.

### 5 Exit Menu List mode

Press the [MENU] button for at least 1 second to return to the first hierarchy. Press the [MENU] button in the first hierarchy to exit the Menu List mode.



- You cannot set the item with the [X] icon displayed.

# iPod/iPhone Operation

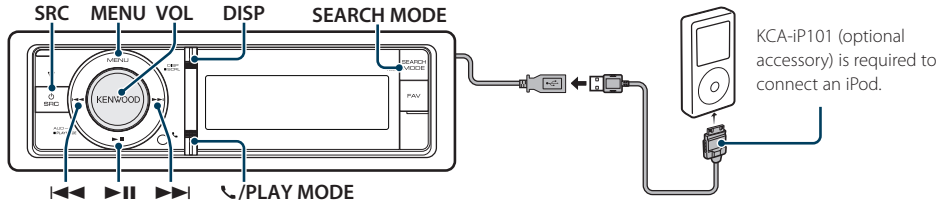

## Basic Operation

### Playing iPod

#### • Connect an iPod

When connected, the source is switched automatically and a song starts playing.

#### • Select iPod source

Press the [SRC] button. Turn the [VOL] knob and press it when the desired item is displayed.

Select the "iPod" display.

↻ SRC Select mode 2: Pressing the [SRC] button repeatedly switches source.

### Song Select

Press the [◀◀] or [▶▶] button.

### Fast Forwards or Fast Backwards

Hold down the [◀◀] or [▶▶] button.

### Pause and Play

Press the [▶II] button to pause or resume playback.

### Remove iPod

Press the [▶II] button for at least 2 seconds.

The unit enters the USB REMOVE mode ("USB REMOVE" is displayed), and the iPod can be removed safely.

## Selecting a song by browsing iPod

Display	Items
"Music"	
"Playlists"	Playlists
"Artists"	Artists
"Albums"	Albums
"Songs"	Songs
"Podcasts"	Podcasts
"Genres"	Genres
"Composers"	Composers

### 1 Select iPod source

### 2 Enter Menu List mode

Press the [MENU] button.

### 3 Turn the [VOL] knob and press it when the desired item is displayed.

Select "Music".

### 4 Select a song

Operation type	Operation
Move between items	Turn the [VOL] knob.
Select an item	Press the [VOL] knob.
High Speed Search	Press the [DISP] or [↵] / [PLAY MODE] button to scroll up or down by a page. Press the [DISP] or [↵] / [PLAY MODE] button for at least 1 second to continuously scroll up or down at high speed. Press the button again to stop scrolling.
Return to previous item	Press the [MENU] button.
Return to Top menu	Press the [MENU] button for at least 1 second.

↻ For example: Searching by Artist name.

Turn the [VOL] knob and press it when the desired item is displayed.

Select "Music" > "Artists" > Artist name > Album name > Song title

### Cancelling Menu List mode

Press the [MENU] button for at least 1 second, and then press it again briefly.



- The unit memorizes the position where you have found a song in the Search mode. When you enter the Menu List mode after searching a song, the memorized position is displayed. Press the [MENU] button for at least 1 second to move to the first hierarchy, select a Menu item, and set its parameters.
- Characters which cannot be displayed are left blank. If non of the characters can be displayed, the browse item name and digits are displayed.

Items	Display	Items	Display
Playlists	"PLIST****"	Podcasts	"PDC****"
Artists	"ART****"	Genres	"GEN****"
Albums	"ALB****"	Composers	"COM****"
Songs	"PRGM****"		

## Play Mode

You can select a Play Mode, such as Random play and Repeat play.

### 1 Select iPod source

### 2 Enter Play Mode Menu

**KDC-X994** **KDC-BT945U**

Press the [VOL] knob for at least 1 second.

**KDC-X794** **KDC-MP745U**

Press the [PLAY MODE] button.

➤ You can also select from "Play Mode" in Menu List mode.

### 3 Select the Play Mode

Turn the [VOL] knob.

Display	Overview
"iPod by Hand"	When set to "ON", allows you to operate iPod with the control on the iPod. "ON"/"OFF"
"Folder Random"	When set to "ON", plays the music in the folder randomly. "ON"/"OFF"
"All Random"	When set to "ON", plays all songs in iPod randomly. "ON"/"OFF"
"File Repeat"	When set to "ON", plays the music repeatedly. "ON"/"OFF"

( \_\_ : Factory setting)

### 4 Make a setting

Press the [◀◀] or [▶▶] button.

### 5 Exit Play Mode Menu

**KDC-X994** **KDC-BT945U**

Press the [MENU] button.

**KDC-X794** **KDC-MP745U**

Press the [PLAY MODE] button.

### Remarks

#### • All Random

- The time required to turn on the all random function may become longer depending on the number of songs in iPod.
- Turning on the all random function changes the iPod browse item to "Songs". This browse item will not be changed even if the all random function is turned off.
- If the browse item is changed to search for music while the all random function is on, the all random function is turned off and the songs in the browse item are played at random.

#### • iPod by Hand (iPod Control by Hand Mode)

Allows you to operate iPod with the control on the iPod.



- In the iPod Control by Hand Mode, iPod cannot be operated using this unit.
- This mode is not compatible with music information display. The display will show "iPod by Hand Mode".
- iPod can be operated when it conforms to the iPod control function.

## iPod Setting

You can select following iPod Setting items.

### 1 Select iPod source

### 2 Enter Menu List mode

Press the [MENU] button.

### 3 Turn the [VOL] knob and press it when the desired item is displayed.

Select "Settings".

### 4 Select the setting item

Turn the [VOL] knob and press it when the desired item is displayed.

Display	Overview
"Settings"	
"Skip Search"	Sets the ratio of skip performed with <Skip Search> (page 12). "0.5%"/"1%"/"5%"/"10%"
"Delete My Playlist"	Deletes the registered My Playlist. Refer to <Deleting a Song from the Playlist> (page 12) for the operation. "One"/"All" → "Yes"/"No"

( \_\_ : Factory setting)

### 5 Make a setting

- When the "[PUSH]" icon is displayed (at the right edge of the display)  
Turn the [VOL] knob to select a setting value, and then press the [VOL] knob.
- When the "[PUSH]" icon is not displayed  
Press the [◀◀] or [▶▶] button to select a setting value.

### 6 Exit Menu List mode

Press the [MENU] button for at least 1 second, and then press it again briefly.



- The setting of "Skip Search" in <iPod Setting> (page 9) and that in <USB Setting> (page 15) are always the same. Changing the setting of one reflects the other.

# iPod/iPhone Operation

## Selecting the Search mode

You can select the most suited search method for the desired song from 4 types of the Search mode.

### Normal playing

Display	Overview
"Direct Search"	You can quickly search the desired song by specifying its Search item (artist, album, etc.) and initial. Refer to <Direct Search> (page 10).
"Related Search"	Searches for music of the same artist or genre as the one being played. Refer to <Related Search> (page 11).
"Recall My Playlist"	Registers a song to My Playlist and play it.
"Delete My Playlist"	Refer to <My Playlist> (page 12).
"Register My P-list"	

### Browsing

Display	Overview
"Direct Search"	You can quickly search the desired song by specifying its Search item (artist, album, etc.) and initial. Refer to <Direct Search> (page 10).
"Alphabet Search"	You can select an alphabetic character from the list in the Search item (artist, album, etc.) selected now. Refer to <Alphabet Search> (page 11).
"Skip Search"	The number of songs to be skipped is determined by the ratio of the total number of songs in the list which is selected now. Refer to <Skip Search> (page 12).
"Register My P-list"	Registers a song to My Playlist. Refer to <My Playlist> (page 12).

### 1 Select iPod source

Press the [SRC] button. Turn the [VOL] knob and press it when the desired item is displayed.

Select the "iPod" display.

➤ SRC Select mode 2: Pressing the [SRC] button repeatedly switches source.

### 2 Enter Search mode

Press the [SEARCH MODE] button.

### 3 Select the Search mode

Turn the [VOL] knob.

### 4 Start the search mode

Press the [VOL] knob.

### Cancelling Search mode

Press the [SEARCH MODE] button.

## Direct Search

You can quickly search the desired song by specifying its Search item (artist, album, etc.) and initial.

### 1 Select iPod source

2 Press the [SEARCH MODE] button.

### 3 Enter Direct Search mode

Turn the [VOL] knob and press it when the desired item is displayed.

Select "Direct Search".

### 4 Select the Search item

Turn the [VOL] knob and press it when the desired Search item is selected.

Display	Items	Display	Items
"PLAYLISTS"	Playlists	"PODCASTS"	Podcasts
"ARTISTS"	Artists	"GENRES"	Genres
"ALBUMS"	Albums	"COMPOSERS"	Composers
"SONGS"	Songs		

### 5 Select the character to be searched for

Operation type	Operation
Move between items	Turn the [VOL] knob.
Select an item	Press the [VOL] knob.
Move to the next column	Press the [◀] or [▶] button.

Up to 3 characters can be entered.

### 6 Determine the selected initial

Turn the [VOL] knob and press it when the desired item is displayed.

Select "DONE".

Start search. When search is completed, the music search mode is selected again at the selected character position.

After this step, you need to browse. See step 4 of <Selecting a song by browsing iPod> (page 8) to select a song.

### Cancelling the Direct Search

Press the [SEARCH MODE] button.



- Characters that can be entered are alphabetical characters (A to Z), numerical characters(0 to 9), and " \* ".
- " \* " indicates characters other than alphabetical and numerical characters. You cannot enter any more characters when entering " \* " in the first character position.
- If the first character string begins with an article "a", "an", or "the" in the Direct Search mode, it is searched for in defiance of the article.

## Related Search

Searches for music of the same artist or genre as the one being played.

### 1 Play the music in iPod

### 2 Press the [SEARCH MODE] button.

### 3 Enter Related Search mode

Turn the [VOL] knob and press it when the desired item is displayed.

Select "Related Search".

### 4 Select the Search item

Turn the [VOL] knob and press it when the desired Search item is selected.

Display	Searches music
"Search Artist"	Displays the album of the same artist.
"Search Album"	Displays music in the album in which the one being played is included.
"Search Genre"	Displays the artist of the same genre.
"Search Composer"	Displays the album including music created by the same Composer.

After this step, you need to browse. See step 4 of [<Selecting a song by browsing iPod> \(page 8\)](#) to select a song.

### Canceling the Related Search

Press the [SEARCH MODE] button.



- Related search cannot be performed while playing the Podcast.
- When the music being played has no information on browsing items or no music was found, "Not Found" is displayed.

## Alphabet Search

You can select a song by alphabet. This function searches songs whose name contain the specified character(s) in the list of the selected Search item (artist, album, etc).

### 1 Select iPod source

### 2 Enter browsing mode

Press the [MENU] button.

Turn the [VOL] knob and press it when the desired item is displayed.

Select "Music" > item.

### 3 Enter Alphabet Search mode

Press the [SEARCH MODE] button.

Turn the [VOL] knob and press it when the desired item is displayed.

Select "Alphabet Search".

### 4 Search for item

Operation type	Operation
Select the character	Press the [DISP] or [⏪] / [PLAY MODE] button.
Move between items	Turn the [VOL] knob.
Select an item	Press the [VOL] knob.
Return to previous item	Press the [MENU] button.

After this step, you need to browse. See step 4 of [<Selecting a song by browsing iPod> \(page 8\)](#) to select a song.

### Canceling the Alphabet Search

Press the [SEARCH MODE] button.



- The time of search by alphabet may become long depending on the number of songs or items in iPod.
- If the first character string begins with an article "a", "an", or "the" in the Alphabet Search mode, it is searched for in defiance of the article.

# iPod/iPhone Operation

## Skip Search

You can scroll up or down according to the number of the selected Search items so that you can quickly switch the display position.

- 1 Select iPod source**
- 2 Enter browsing mode**  
Press the [MENU] button.  
Turn the [VOL] knob and press it when the desired item is displayed.  
Select "Music" > item.
- 3 Press the [SEARCH MODE] button.**
- 4 Enter Skip Search mode**  
Turn the [VOL] knob and press it when the desired item is displayed.  
Select "Skip Search".
- 5 Search for item**

Operation type	Operation
Move between items	Turn the [VOL] knob.
Select an item	Press the [VOL] knob.
Skip Search	Press the [DISP] or [ ] / [PLAY MODE] button. Keep pressing the button for 3 seconds or longer skips songs at 10% irrespective of the setting.
Sets the ratio of skip performed	Press the [◀◀] or [▶▶] button.
Return to previous item	Press the [MENU] button.

After this step, you need to browse. See step 4 of <Selecting a song by browsing iPod> (page 8) to select a song.

### Canceling the Skip Search

Press the [SEARCH MODE] button.



- Set the ratio with "Skip Search" in <iPod Setting> (page 9).

## My Playlist

Allows you to register your favorite songs in the Playlist of this unit. You can register up to 10 songs in the Playlist.

### Registering Songs in the Playlist

- 1 Play the song you want to register**
- 2 Press the [SEARCH MODE] button.**
- 3 Register the song**  
Turn the [VOL] knob and press it when the desired item is displayed.  
Select "Register My Playlist".  
"## Stored (Registration number)" is displayed.



- Make a Playlist from the songs stored in one iPod. If you attempt to register a song stored in a different iPod, "No Information" appears and then "Delete My Playlist" appears. Select "Yes" to delete the Playlist when you want to remake it.
- The song displayed in the Music Search mode can be registered in the same manner. For how to use the music search function, refer to <Selecting a song by browsing iPod> (page 8).
- If you attempt to register the eleventh song, "Memory Full" appears and you cannot register it accordingly. To register the song, delete an unnecessary song.
- Do not register Podcasts. Songs you do not want to register may be registered, or playback may not be carried out correctly.

### Playing the Song in the Playlist

- 1 Press the [SEARCH MODE] button.**
- 2 Enter My Playlist mode**  
Turn the [VOL] knob and press it when the desired item is displayed.  
Select "Recall My Playlist".
- 3 Play the song in the Playlist**  
Turn the [VOL] knob and press it when the desired item is displayed.  
Select the song you want to play.



- Turning ACC OFF or the power OFF cancels the My Playlist mode.
- The ending of a song may be cut unless the song has a silence of 1 second or longer at the end.
- Random play cannot be performed during playback of a song in the Playlist.

### Deleting a Song from the Playlist

- 1 Press the [SEARCH MODE] button.**

## 2 Enter Delete Playlist mode

Turn the [VOL] knob and press it when the desired item is displayed.

Select "Delete My Playlist".

## 3 Turn the [VOL] knob and press it when the desired item is displayed.

Select "Delete One" or "Delete All".

Selecting "Delete All" moves to step 5 and all songs are deleted.

## 4 Turn the [VOL] knob and press it when the desired item is displayed.

Select the song you want to delete.

## 5 Turn the [VOL] knob and press it when the desired item is displayed.

Select "Yes".

"Complete" is displayed.



- You can also delete all songs from the Playlist by selecting "Delete My Playlist" described in [<iPod Setting> \(page 9\)](#).
- If you connect the different iPod from one registered to My Playlist, "Delete One" and "Delete All" will not appear and all songs be deleted.

# USB device Operation

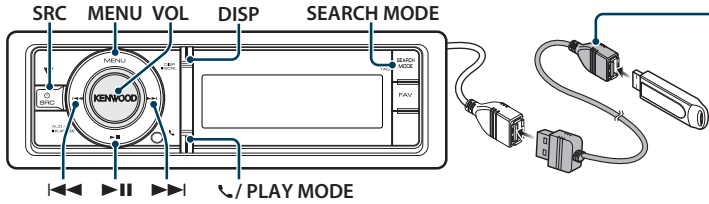

When connecting the USB device, usage of the CA-U1EX (option) is recommended.

## Basic Operation

### Playing USB device

- **Connect a USB device**  
When connected, the source is switched automatically and a song starts playing.
- **Select USB source**  
Press the [SRC] button. Turn the [VOL] knob and press it when the desired item is displayed.  
Select the "USB" display.  
➤ SRC Select mode 2: Pressing the [SRC] button repeatedly switches source.

### Moving to the next folder

Press the [SEARCH MODE] button.

### Song Select

Press the [◀◀] or [▶▶] button.

### Fast Forwards or Fast Backwards

Hold down the [◀◀] or [▶▶] button.



- No sound is output while playing audio file.

### Pause and Play

Press the [▶II] button to pause or resume playback.

### Remove USB device

Press the [▶II] button for at least 2 seconds.  
The unit enters the USB REMOVE mode ("USB REMOVE" is displayed.), and the USB device can be removed safely.

## File Search

Selecting the file you want to listen to from the device being played now.

### USB device

Display	Items
"Music"	Folder or file name list.

### Music Editor media

Display	Items
"Music"	
"Playlists"	Playlists
"Artists"	Artists
"Albums"	Albums
"Songs"	Songs
"Genres"	Genres

- 1 **Select USB source**
- 2 **Enter Menu List mode**  
Press the [MENU] button.
- 3 **Turn the [VOL] knob and press it when the desired item is displayed.**  
Select "Music".
- 4 **Select a file**

Operation type	Operation
Move between items	Turn the [VOL] knob.
Select an item	Press the [VOL] knob.
High Speed Search	Press the [DISP] or [↵] / [PLAY MODE] button to scroll up or down by a page. Press the [DISP] or [↵] / [PLAY MODE] button for at least 1 second to continuously scroll up or down at high speed. Press the button again to stop scrolling.
Return to previous item	Press the [MENU] button.
Return to Top menu	Press the [MENU] button for at least 1 second.

➤ For example: Searching for 🎵②.

Turn the [VOL] knob and press it when the desired item is displayed.

Select "Music" > [1] > [2] > 🎵②

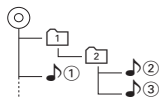

### Cancelling Menu List mode

Press the [MENU] button for at least 1 second, and then press it again briefly.



- When you search a song in the File Search mode, the unit memorizes the position of the song being played after the search. To set a different Menu item after searching a song, press the [MENU] button for at least 1 second to move to the first hierarchy.

## Play Mode

You can select a Play Mode, such as Random play and Repeat play.

### 1 Select USB source

### 2 Enter Play Mode

**KDC-X994** **KDC-BT945U**

Press the [VOL] knob for at least 1 second.

**KDC-X794** **KDC-MP745U**

Press the [PLAY MODE] button.

- You can also select from "Play Mode" in Menu List mode.

### 3 Select the Play Mode

Turn the [VOL] knob.

Display	Overview
"File Scan"	When set to "ON", plays the intro of the music in the folder successively. "ON" / "OFF"
"Folder Random"	When set to "ON", plays the music in the folder randomly. "ON" / "OFF"
"File Repeat"	When set to "ON", plays the music repeatedly. "ON" / "OFF"
"Folder Repeat"	When set to "ON", plays the music in the folder repeatedly. "ON" / "OFF"

( \_ : Factory setting)

### 4 Make a setting

Press the [◀◀] or [▶▶] button.

### 5 Exit Play Mode

**KDC-X994** **KDC-BT945U**

Press the [MENU] button.

**KDC-X794** **KDC-MP745U**

Press the [PLAY MODE] button.

## USB Setting

You can select following USB Setting items.

### 1 Select USB source

### 2 Enter Menu List mode

Press the [MENU] button.

### 3 Turn the [VOL] knob and press it when the desired item is displayed.

Select "Settings".

### 4 Select the setting item

Turn the [VOL] knob and press it when the desired item is displayed.

Display	Overview
"Settings"	
"Skip Search"	Sets the ratio of skip performed with <Skip Search> (page 16). "0.5%"/"1%"/"5%"/"10%"

( \_ : Factory setting)

### 5 Make a setting

Press the [◀◀] or [▶▶] button.

### 6 Exit Menu List mode

Press the [MENU] button for at least 1 second, and then press it again briefly.



- The setting of "Skip Search" in <iPod Setting> (page 9) and that in <USB Setting> (page 15) are always the same. Changing the setting of one reflects the other.

# USB device Operation

## Skip Search

You can scroll up or down according to the number of the selected Search items so that you can quickly switch the display position.

### 1 Select USB source

### 2 Enter File Search mode

Press the [MENU] button.

Turn the [VOL] knob and press it when the desired item is displayed.

Select "Music" > item.

### 3 Enter Skip Search mode

Press the [SEARCH MODE] button.

### 4 Search for music

Operation type	Operation
Move between items	Turn the [VOL] knob.
Select an item	Press the [VOL] knob.
Skip Search	Press the [DISP] or [↶] / [PLAY MODE] button. Keep pressing the button for 3 seconds or longer skips songs at 10% irrespective of the setting.
Sets the ratio of skip performed	Press the [◀◀] or [▶▶] button.
Return to previous item	Press the [MENU] button.

After this step, see step 4 of <File Search> (page 14) to select a song.

## Cancelling the Skip Search

Press the [SEARCH MODE] button.



- This operation is effective only for the files registered in the database created with KENWOOD Music Editor.
- Set the ratio with "Skip Search" in <USB Setting> (page 15).

## Function of remote control

### Direct Music Search

Searching the music by entering the file number.

#### 1 Enter Direct Music Search mode

Press the [DIRECT] button on the remote control.

#### 2 Enter the music number

Press the number buttons on the remote control.

#### 3 Search the music

Press the [◀◀] or [▶▶] button.

### Cancelling Direct Music Search

Press the [DIRECT] button.



- Direct Music Search cannot be performed during playing of "Music Editor" media, Random play, or scan play.

# Music CD/ Audio file Operation

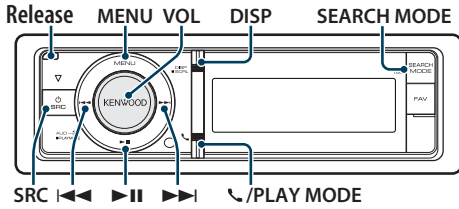

## Basic Operation

### Drop open the faceplate

Press the Release button.



- Push the faceplate on the left side, and return it to its former position.

### Disc play

- A disc inserted.

When inserted, the source is switched automatically and a song is starts playing.

When a CD is inserted, the "CD-IN" indicator is ON.

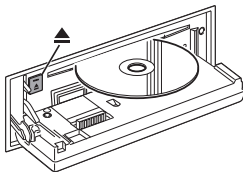

- **Select CD source**

Press the [SRC] button. Turn the [VOL] knob and press it when the desired item is displayed.

Select the "CD" display.

- SRC Select mode 2: Pressing the [SRC] button repeatedly switches source.

### Disc ejection

Press the [▲] button.

### Moving to the next folder

Press the [SEARCH MODE] button.



- This operation can be performed only for the Audio file.

### Song Select

Press the [◀◀] or [▶▶] button.

### Fast Forwards or Fast Backwards

Hold down the [◀◀] or [▶▶] button.



- No sound is output while playing audio file.

### Pause and Play

Press the [▶||] button to pause or resume playback.

### Function of Internal CD source

## Music Search

Selecting the music you want to listen to from the disc being played now.

Display	Overview
"Music"	Track list (Music CD) / Folder or file name list (Audio file)

### 1 Select CD source

### 2 Enter Menu List mode

Press the [MENU] button.

### 3 Turn the [VOL] knob and press it when the desired item is displayed.

Select "Music".

### 4 Search for music

Operation type	Operation
Move between items	Turn the [VOL] knob.
Select an item	Press the [VOL] knob.
High Speed Search	Press the [DISP] or [↵] / [PLAY MODE] button to scroll up or down by a page. Press the [DISP] or [↵] / [PLAY MODE] button for at least 1 second to continuously scroll up or down at high speed. Press the button again to stop scrolling.
Return to previous item	Press the [MENU] button.
Return to Top menu	Press the [MENU] button for at least 1 second.

### Canceling Menu List mode

Press the [MENU] button for at least 1 second, and then press it again briefly.

# Music CD/ Audio file Operation

## Play Mode

You can select a Play Mode, such as Random play and Repeat play.

### 1 Select CD source

### 2 Enter Play Mode

**KDC-X994** **KDC-BT945U**

Press the [VOL] knob for at least 1 second.

**KDC-X794** **KDC-MP745U**

Press the [PLAY MODE] button.

⇒ You can also select from "Play Mode" in Menu List mode.

### 3 Select the Play Mode

Turn the [VOL] knob.

#### Music CD source

Display	Overview
"Track Scan"	When set to "ON", plays the intro of the music on the disc successively. "ON"/"OFF"
"Disc Random"	When set to "ON", plays the music on the disc randomly. "ON"/"OFF"
"Track Repeat"	When set to "ON", plays the music repeatedly. "ON"/"OFF"

( \_\_ : Factory setting)

#### Audio file source

Display	Overview
"File Scan"	When set to "ON", plays the intro of the music on the disc successively. "ON"/"OFF"
"Folder Random"	When set to "ON", plays the music on the disc randomly. "ON"/"OFF"
"File Repeat"	When set to "ON", plays the music repeatedly. "ON"/"OFF"
"Folder Repeat"	When set to "ON", plays the music on the disc repeatedly. "ON"/"OFF"

( \_\_ : Factory setting)

#### Disc changer source

Display	Overview
"Track Scan"	When set to "ON", plays the intro of the music on the disc successively. "ON"/"OFF"
"Disc Random"	When set to "ON", plays the music on the disc randomly. "ON"/"OFF"
"Magazine Random"	When set to "ON", plays the music in the disc changer randomly. "ON"/"OFF"

"Track Repeat"	When set to "ON", plays the music repeatedly. "ON"/"OFF"
"Disc Repeat"	When set to "ON", plays the music on the disc repeatedly. "ON"/"OFF"

( \_\_ : Factory setting)

### 4 Make a setting

Press the [◀◀] or [▶▶] button.

### 5 Exit Play Mode

**KDC-X994** **KDC-BT945U**

Press the [MENU] button.

**KDC-X794** **KDC-MP745U**

Press the [PLAY MODE] button.

## Basic Operation of Disc Changer (Optional)

### Select CD changer source

Press the [SRC] button. Turn the [VOL] knob and press it when the desired item is displayed.

Select the "CD CHANGER" display.

⇒ SRC Select mode 2: Pressing the [SRC] button repeatedly switches source.

### Moving to the next disc

Press the [SEARCH MODE] button.

### Song Select

Press the [◀◀] or [▶▶] button.

### Fast Forwards or Fast Backwards

Hold down the [◀◀] or [▶▶] button.

### Pause and Play

Press the [▶||] button to pause or resume playback.

*Function of remote control*

## **Direct Music Search**

---

Searching the music by entering the track number.

### **1 Enter Direct Music Search mode**

Press the [DIRECT] button on the remote control.

### **2 Enter the music number**

Press the number buttons on the remote control.

### **3 Search the music**

Press the [◀◀] or [▶▶] button.

### **Cancelling Direct Music Search**

Press the [DIRECT] button.



- Direct Music Search cannot be performed during playing of Random play or scan play.

*Function of disc changer with remote control*

## **Direct Disc Search**

---

Searching the disc by entering the disc number.

### **1 Enter Direct Disc Search mode**

Press the [DIRECT] button on the remote control.

### **2 Enter the disc number**

Press the number buttons on the remote control.

### **3 Search the disc**

Press the [FM] or [AM] button.

### **Cancelling Direct Disc Search**

Press the [DIRECT] button.



- Direct Disc Search cannot be performed during Random play or scan play.
- Input "0" to select disc 10.

# Tuner Operation

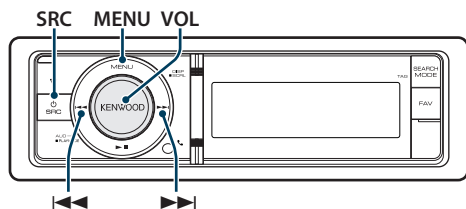

"Auto Memory"	Memorizes 6 stations with good reception automatically. Refer to <Auto Memory Entry> (page 21)
"TI"	Switches to the traffic information automatically when the traffic bulletin starts. (KDC-X994/KDC-X794 only) "OFF"/"ON"
"Forced MONO"	You can reduce the noise when stereo broadcasts are received as monaural. "OFF"/"ON"

( \_ : Factory setting)

## Basic Operation

### Selecting Tuner source

Press the [SRC] button. Turn the [VOL] knob and press it when the desired item is displayed.

Select the "Tuner" display.

↻ SRC Select mode 2: Pressing the [SRC] button repeatedly switches source.

### Selecting the Receiving Band

#### 1. Enter Menu List mode

Press the [MENU] button.

#### 2. Turn the [VOL] knob and press it when the desired item is displayed.

Select "FM1", "FM2", "FM3" or "AM".

### Selecting the Receiving station

Press the [◀◀] or [▶▶] button.

↻ Details of the station selecting in operation are set in the "Seek Mode" of <Tuner Setting> (page 20).

## Tuner Setting

You can select following Tuner Setting items.

### 1 Select Tuner source

### 2 Enter Menu List mode

Press the [MENU] button.

### 3 Turn the [VOL] knob and press it when the desired item is displayed.

Select "Settings".

### 4 Select the setting item to adjust

Turn the [VOL] knob and press it when the desired item is displayed.

Display	Overview
"Settings"	
"Seek Mode"	Selects the tuning mode of the radio. "Auto1": Automatic search for a station. "Auto2": Search in order of the stations in the Preset memory. "Manual": Normal manual tuning control.

### 5 Make a setting

Press the [◀◀] or [▶▶] button.

### 6 Exit Menu List mode

Press the [MENU] button for at least 1 second, and then press it again briefly.

### Remarks

#### • Forced MONO

Strong electrical fields (such as from power lines) may cause unstable sound quality when it is set to ON. In such a situation, turn it OFF.

#### • Traffic information (TI)

Turns ON or OFF the Traffic Information function. When the function is set to ON, "TI" indicator is ON. If traffic bulletin starts when the function is ON, "Traffic INFO" is displayed and traffic information is received.

If the volume is adjusted during reception of traffic information, the adjusted volume is memorized automatically. The memorized volume will be applied next time the Traffic Information function is turned ON.

## Station Preset Memory

Putting a station in the memory.

- 1 Select the radio band and tune in a desired radio station you wish to store in the preset memory**
- 2 Enter Menu List mode**  
Press the [MENU] button.
- 3 Enter Preset Memory mode**  
Turn the [VOL] knob and press it when the desired item is displayed.  
Select "List & Memory".
- 4 Select the number to put in the memory**  
Turn the [VOL] knob and press it for at least 2 seconds when the desired item is displayed.  
Select a preset number.

Display	Overview
"List & Memory"	
"-1"	Preset number 1.
"-2"	Preset number 2.
:	
"-6"	Preset number 6.

### Canceling the Preset Memory mode

Press the [MENU] button for at least 1 second, and then press it again briefly.

## Auto Memory Entry

Putting stations with good reception in the memory automatically.

- 1 Select the radio band you wish to store in the preset memory**
- 2 Enter Menu List mode**  
Press the [MENU] button.
- 3 Enter Auto Memory Entry mode**  
Turn the [VOL] knob and press it when the desired item is displayed.  
Select "Settings" > "Auto Memory".
- 4 Open Auto Memory Entry**  
Turn the [VOL] knob and press it when the desired item is displayed.  
Select "YES".

When 6 stations that can be received are put in the memory, auto memory entry closes.

## Preset Tuning

Recalling the stations in the memory.

- 1 Select the radio band**
- 2 Select a desired station in the memory**  
Turn the [VOL] knob and press it when the desired item is displayed.  
Select "List & Memory" > Preset number.

*Function of remote control*

## Direct Access Tuning

Tuning in a desired radio station by entering the frequency.

- 1 Select the radio band**
- 2 Enter Direct Access Tuning mode**  
Press the [DIRECT] button on the remote control.  
"- - - -" is displayed.
- 3 Enter the frequency**  
Press the number buttons on the remote control.

Example:

Desired frequency	Press button
92.1 MHz (FM)	[9], [2], [1]
810 kHz (AM)	[8], [1], [0]

- 4 Tune in to the entered frequency**  
Press the [◀◀] or [▶▶] button.

### Canceling Direct Access Tuning

Press the [DIRECT] button on the remote control.

# Tuner Operation

Function of KDC-X994/KDC-X794

## PTY (Program Type)

Selecting the Program Type below and searching for a station.

Program Type	Display	Program Type	Display
Speech	"Speech"	Soft	"Soft"
Music	"Music"	Nostalgia	"Nostalga"
News	"News"	Jazz	"Jazz"
Information	"Inform"	Classical	"Classical"
Sports	"Sports"	R & B	"R & B"
Talk	"Talk"	Soft R & B	"Soft R&B"
Rock	"Rock"	Language	"Language"
Classic Rock	"Cls Rock"	Religious Music	"Rel Musc"
Adult Hits	"Adlt Hit"	Religious Talk	"Rel Talk"
Soft Rock	"Soft Rck"	Personality	"Persnlty"
Top 40	"Top 40"	Public	"Public"
Country	"Country"	College	"College"
Oldies	"Oldies"	Weather	"Weather"

- Speech and Music include the Program type shown below.  
Speech: Items in the white letters.  
Music: Items in the black letters.

### 1 Enter Menu List mode

Press the [MENU] button.

### 2 Select the FM band

Turn the [VOL] knob and press it when the desired item is displayed.  
Select "FM1", "FM2", or "FM3".

### 3 Enter Menu List mode

Press the [MENU] button.

### 4 Enter PTY mode

Turn the [VOL] knob and press it when the desired item is displayed.  
Select "PTY Search".

### 5 Select the Program Type

Turn the [VOL] knob.

### 6 Search for the selected Program Type station

Press the [◀◀] or [▶▶] button.

### 7 Exit PTY mode

Press the [MENU] button.



- This function cannot be used during a traffic bulletin or AM reception.
- When the selected Program Type is not found, "No PTY" is displayed. Select another Program Type.
- The operation ends automatically if you do not operate within 30 seconds.

Function of KDC-X994/KDC-X794

## Program Type Preset

Putting the Program Type in the Preset button memory and quick recall.

### Presetting the Program Type

#### 1 Select the Program Type to preset

Refer to <PTY (Program Type)> (page 22).

#### 2 Enter Program Type Preset mode

Press the [SEARCH MODE] button.

#### 3 Select the number to put in the memory

Turn the [VOL] knob and press it for at least 2 seconds when the desired item is displayed.  
Select preset number.

### Recalling the preset Program Type

#### 1 Enter PTY mode

Refer to <PTY (Program Type)> (page 22).

#### 2 Enter Program Type Preset mode

Press the [SEARCH MODE] button.

#### 3 Select a desired Program Type in the memory

Turn the [VOL] knob and press it when the desired item is displayed.  
Select preset number.

## Bluetooth Audio Operation

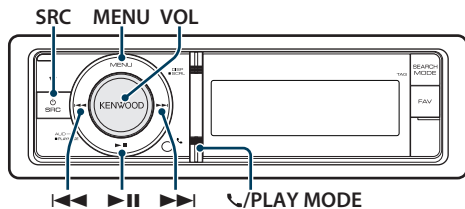

### Connecting a Bluetooth Device

Before use the Bluetooth device, you need to connect Bluetooth device to this unit.

#### Pairing (Registering from Bluetooth devices)

To make your Bluetooth Audio player usable with this unit, you need to register it (pairing).

**1 Turn on this unit**  
Press the [SRC] button.

**2 Start registering this unit by operating the Bluetooth device**

By operating the Bluetooth device, register the audio player (pairing). Select "KENWOOD BT CD/R-4P1"/"KCA-BT200" from the list of connected units.

**3 Enter a PIN code**  
Input the PIN code ("0000") in the Bluetooth device.

Check that registration is complete on the Bluetooth device.

✎ PIN code is set to "0000" as the default. You can change this code. Refer to <Registering PIN Code> (page 50).

**4 By operating the Bluetooth device, start Bluetooth connection.**



- If pairing does not succeed, try followings.
  - PIN code is set to "0000". See <Registering PIN Code> (page 50)
  - Turn off the power of this unit and turn it back on. And then try the pairing operation again.
  - If other audio players have been registered, delete them. And then try the pairing operation again. See <Deleting a Registered Bluetooth device> (page 51)
- When registering from this unit, refer to <Registering Bluetooth device> (page 49).
- For details on the Bluetooth Audio player which can be connected, see <About the Bluetooth Audio player> (page 63).

### Basic Operation

#### Selecting Bluetooth Audio source

Press the [SRC] button. Turn the [VOL] knob and press it when the desired item is displayed.

Select the "BT Audio" display.

✎ SRC Select mode 2: Pressing the [SRC] button repeatedly switches source.

#### Pause and play

Press the [▶||] button.

#### Music Search

Press the [◀◀] or [▶▶] button.



- All or some of the operations above cannot be performed if the Bluetooth audio player is not ready for remote control.
- Switching to the Bluetooth audio source does not start or stop playback automatically. Perform the operation for starting or stopping playback.
- Some audio players cannot be controlled remotely or reconnected after Bluetooth disconnection. Operate the main unit of the audio player to connect Bluetooth.

## Operation of hands-free phoning

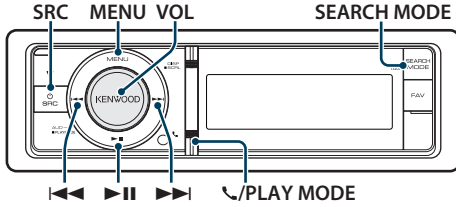

- When registering from this unit, refer to <Registering Bluetooth device> (page 49).
- For details on the Bluetooth cell-phone with the hands-free function, see <About the Cell-Phone> (page 63).

### Connecting a Bluetooth Device

Before use the Bluetooth device, you need to connect Bluetooth device to this unit. The following 3 steps procedure is necessary.

#### Step 1. Pairing (Registering from Bluetooth devices)

To make your Bluetooth device (cell-phone) usable with this unit, you need to register it (pairing).

**1 Turn on this unit**  
Press the [SRC] button.

**2 Start registering this unit by operating the Bluetooth device**

By operating the Bluetooth device, register the hands-free unit (pairing). Select "KENWOOD BT CD/R-4P1"/"KCA-BT200" from the list of connected units.

**3 Enter a PIN code**  
Input the PIN code ("0000") in the Bluetooth device.

Check that registration is complete on the Bluetooth device.

✎ PIN code is set to "0000" as the default. You can change this code. Refer to <Registering PIN Code> (page 50).

**4 By operating the Bluetooth device, start hands-free connection.**

#### Step 2. Connection

If you have registered 2 or more cell-phones, you need to select one of them. For more details, see <Selecting the Bluetooth device You Wish to Connect> (page 50).

When a cell-phone is connected, the "BT" indicator is light up.

#### Step 3. Hands-free phoning

You can do hand-free phoning when the connection is made.

### Receiving a Call

#### Answering a Phone Call

Press the [VOL] knob.



- The following operations disconnect the line:
  - Insert a CD.
  - Connect a USB device.
- The name of the calling party is displayed if it has already been registered in the Phone Book.

#### Rejecting an Incoming Call

Press the [SRC] button or press the [PHONE] / [PLAY MODE] button for at least 1 second.

### During a Call

#### Disconnecting a Call

Press the [SRC] button or press the [PHONE] / [PLAY MODE] button for at least 1 second.

#### Switching to the Private Mode

Press the [PAUSE] knob.

Switches between Private talk ("PRIVATE") and Hands-free talk each time this button is pressed.



- Depending on the type of your cell-phone, switching to the private talk mode may select the source that was used before commencing the hands-free connection. If this happens, the source cannot be switched back to the hands-free talk mode by operating this unit. Operate your cell-phone to return to the hands-free talk mode.

#### Adjusting the Voice Volume during a Call

Turn the [VOL] knob.

### Call Waiting

#### Answering Another Incoming Call with the Current Call Suspended

**1** Press the [VOL] knob.

**2** Turn the [VOL] knob and press it when the desired item is displayed.  
Select "ANSWER".

### **Answering another Incoming Call after Terminating the Current Call**

Press the [SRC] button.

### **Continuing the Current Call**

- 1 Press the [VOL] knob.
- 2 Turn the [VOL] knob and press it when the desired item is displayed.  
Select "REJECT".

### **Answering the Waiting Call after Terminating the Current Call**

Press the [SRC] button.

### **Switching between the Current Call and Waiting Call**

Press the [VOL] knob.

Each pressing of this knob switches the calling party.

## **Other Functions**

### **Clearing the Disconnection Message**

**KDC-X994** **KDC-BT945U**

Press the [ ] button.

**KDC-X794** **KDC-MP745U**

Press the [PLAY MODE] button for at least 1 second.

"HF Disconnect" disappears.

## **Making a Call**

### **1 Enter Bluetooth mode**

**KDC-X994** **KDC-BT945U**

Press the [ ] button.

**KDC-X794** **KDC-MP745U**

Press the [PLAY MODE] button for at least 1 second.

### **2 Select a dialing method**

Turn the [VOL] knob and press it when the desired item is displayed.

Display	Overview
"Preset Call"	Calling a number in the preset.
"Phonebook"	Selecting the initial to be searched for the phone book.
"In Call"	Calling a number in the incoming call list.
"Out Call"	Calling a number in the outgoing call list.
"Missed Call"	Calling a number in the missed calls list.
"Number Dial"	Making a call by entering phone number.

Operation method of each mode is described

below.

### **3 Exit the dialing method mode**

**KDC-X994** **KDC-BT945U**

Press the [ ] button.

**KDC-X794** **KDC-MP745U**

Press the [PLAY MODE] button for at least 1 second.

## **Speed Dialing (Preset Dial)**

### **1 Enter Bluetooth mode**

**KDC-X994** **KDC-BT945U**

Press the [ ] button.

**KDC-X794** **KDC-MP745U**

Press the [PLAY MODE] button for at least 1 second.

### **2 Select the preset dial mode**

Turn the [VOL] knob and press it when the desired item is displayed.  
Select "Preset call".

### **3 Select the number you want to recall from the memory**

Turn the [VOL] knob and press it when the desired item is displayed.  
Select preset number.  
Phone number is displayed.

### **4 Exit the preset dial mode**

Press the [MENU] button.

### **5 Make a call**

Press the [VOL] knob.



- You need to register the preset dial number. Refer to [<Registering to the Preset Dial Number List>](#) (page 27).

## Operation of hands-free phoning

### Calling a Number in the Phone Book

#### 1 Enter Bluetooth mode

**KDC-X994** **KDC-BT945U**

Press the  button.

**KDC-X794** **KDC-MP745U**

Press the [PLAY MODE] button for at least 1 second.

#### 2 Select the Phone Book mode

Turn the [VOL] knob and press it when the desired item is displayed.

Select "Phonebook".

#### 3 Select the initial to be searched for

Operation type	Operation
Move to the next character.	Turn the [VOL] knob.
Move to the next row.	Press the [◀◀] or [▶▶] button.
Determine the selected initial.	Press the [VOL] knob for at least 1 second.

#### 4 Select the name

Operation type	Operation
Move to the next phone number.	Turn the [VOL] knob.
Determine the selected phone number.	Press the [VOL] knob.

#### Switching between Display Modes

Press the [DISP] button.

Pressing this button each time switches between name and telephone number.

#### 5 Make a call

Press the [VOL] knob.



- During search, a non-accent character such as "u" is searched for instead of an accent character such as "ü".

### Calling a Number in the Call log

#### 1 Enter Bluetooth mode

**KDC-X994** **KDC-BT945U**

Press the  button.

**KDC-X794** **KDC-MP745U**

Press the [PLAY MODE] button for at least 1 second.

#### 2 Select the call log mode

Turn the [VOL] knob and press it when the desired item is displayed.

Select "Out Call" (outgoing call), "In Call" (incoming call), or "Missed Call" (missed call).

#### 3 Select a name or phone number

Turn the [VOL] knob and press it when the desired item is displayed.

#### Switching between Display Modes

Press the [DISP] button.

Pressing this button each time switches between name and telephone number.

#### 4 Make a call

Press the [VOL] knob.



- The outgoing call list and the incoming call list, and the missed call list are the lists of calls originated from and received at this unit. They are not the ones stored in the cell-phone memory.

### Dial a Number

#### 1 Enter Bluetooth mode

**KDC-X994** **KDC-BT945U**

Press the  button.

**KDC-X794** **KDC-MP745U**

Press the [PLAY MODE] button for at least 1 second.

#### 2 Select the number dial mode

Turn the [VOL] knob and press it when the desired item is displayed.

Select "Number Dial".

#### 3 Enter a phone number

Operation type	Operation
Select the numbers.	Turn the [VOL] knob.
Move to the next digit.	Press the [▶▶] button.
Delete the last digit.	Press the [◀◀] button.

- Press the number ([1] – [0]), #[FM]), \*([AM]), or +([▶▶]) button on the remote controller.

#### To erase the entered phone number digit by digit:

Press the [◀◀] button on the remote controller.

#### 4 Make a call

- Press the [VOL] knob.
- Press the [DIRECT] button on the remote controller.



- You can input max 32 digits.

## Make a Voice Dialing Call

### 1 Enter voice recognition mode

Press the [VOL] knob for at least 1 second.

### 2 "PB Name?" is displayed.

When a beep is heard, say the name within 2 seconds.

### 3 "PN Type" is displayed.

When a beep is heard, say the category name within 2 seconds.

### 4 Make a call

Press the [VOL] knob.

 This step is the same as step 4 of the procedure in <Calling a Number in the Phone Book> (page 26). You can make a call or select a category.



- If your voice cannot be recognized, a message is displayed. Pressing the [VOL] knob allows you to retry voice input. Refer to <Troubleshooting Guide> (page 74).
- Both the name and category require registration of a voice tag. Refer to <Setting a Voice Command for Category> (page 52).
- Audio sound is not output during voice recognition.

## Registering to the Preset Dial Number List

### 1 Select the phone number you wish to register

Select the phone number with reference to the following:

- Calling a Number in the Phone Book (page 26)
- Calling a Number in the Call log (page 26)

### 2 Enter Preset Memory mode

Press the [VOL] button for at least 2 seconds.

### 3 Select the Preset number to put in the memory

Turn the [VOL] knob and press it for at least 1 second when the desired item is displayed. Select preset number.

### 4 Determine the Preset number to put in the memory

Turn the [VOL] knob and press it when the desired item is displayed.

### Exit the Preset Memory mode

Press the [MENU] button.

## Display of Phone Number type (category)

The category items in the Phone Book are displayed as follows:

Display	Information
"GENERAL" / "☺"	General
"HOME" / "🏠"	Home
"OFFICE" / "📠"	Office
"MOBILE" / "📱"	Mobile
"OTHER" / "🔍"	Other

# Display Settings

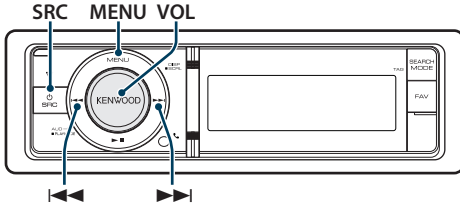

## Basic Operation

### Switching display

Press the [DISP] button.

Mode	Display Type
5-line display mode	Displays 4 to 5 lines of text.
3-line display mode	Displays 2 to 3 lines of text.
iPod-like display mode	Displays like iPod. (iPod source only)
Spectrum analyzer display mode	Displays a line of text and the spectrum analyzer.
Clock display mode	Displays the clock.



- When the 5-line display mode is selected, the status (ON/OFF indicator of each function) can be displayed on the first line, and the icon of the currently selected source and the text information title can be displayed on the left side by the following <Customization of 5-line Display Mode & 3-line Display Mode & iPod-like Display Mode> (page 30) operation.  
 Status display: Select "Settings" > "DISP & ILLUMI" > "Display Select" > "Status"  
 Side display: Select "Settings" > "DISP & ILLUMI" > "Display Select" > "Side Select"

### Text scroll

Press the [DISP] button for at least 1 second.

The displayed text scrolls.

## Display Setting

You can select following Display Setting items.

### 1 Select the source

Press the [SRC] button. Turn the [VOL] knob and press it when the desired item is displayed.

➤ SRC Select mode 2: Pressing the [SRC] button repeatedly switches source.

### 2 Enter Menu List mode

Press the [MENU] button.

### 3 Enter Display Setting mode

Turn the [VOL] knob and press it when the desired item is displayed.

Select "Settings" > "DISP & ILLUMI".

### 4 Select the setting item to adjust

Turn the [VOL] knob and press it when the desired item is displayed.

Display	Overview
"Settings"	
"DISP & ILLUMI"	Making Display and Illumination settings.
"Display Select"	Selecting and customizing the Display type.
"Color Select"	Selecting the Illumination Color of the panel. Refer to <Illumination Color Selection> (page 32)
"Display Off Mode"	If this unit is not operated at least 5 seconds with "OFF" selected, the display turns off. During a setup mode, the display will not turn off even if 5 seconds lapse. "OFF"/"ON"
"Display Dimmer"	Reduces the display Illumination brightness. "Auto": Dims the illumination in conjunction with the Light switch of the vehicle. "Manual1": Dims the illumination constantly. "Manual2": Dims the illumination darker than Manual1. "OFF": Does not dim the illumination.
"Contrast"	Adjusting the display contrast. "1" - "5" - "12"
"DISP N/P"	Switches the panel display between positive or negative. "POS1"/"POS2"/"NEGA1"/"NEGA2"
"TEXT Scroll"	Specifies whether the text is scrolled automatically. "Auto"/"Manual"
"ILLUMI Dimmer"	Reduces the key Illumination brightness. "Auto": Dims the illumination in conjunction with the Light switch of the vehicle. "Manual1": Dims the illumination constantly. "Manual2": Dims the illumination darker than Manual1. "OFF": Does not dim the illumination.

"ILLUMI Effect"	Sets whether the key illumination brightness is changed in conjunction with the key operation. "OFF"/"ON"
"ILLUMI MSC SYNC"	Sets whether the key illumination color is changed in conjunction with the sound volume. (KDC-X994 only) "OFF"/"ON"

( \_ : Factory setting)

## 5 Make a setting

- When the "PUSH" icon is displayed (at the right edge of the display)  
Turn the [VOL] knob to select a setting value, and then press the [VOL] knob.
- When the "PUSH" icon is not displayed  
Press the [◀▶] or [▶▶] button to select a setting value.

## 6 Exit Menu List mode

Press the [MENU] button for at least 1 second, and then press it again briefly.

# Display Settings

## Customization of 5-line Display Mode & 3-line Display Mode & iPod-like Display Mode

You can customize the display of the 5-line display mode, 3-line display mode, and iPod-like display mode.

### 1 Select the source

Press the [SRC] button. Turn the [VOL] knob and press it when the desired item is displayed.

➤ SRC Select mode 2: Pressing the [SRC] button repeatedly switches source.

### 2 Enter Menu List mode

Press the [MENU] button.

### 3 Enter Display Setting mode and Select the 5-line display mode, 3-line display mode or iPod-like display mode.

Turn the [VOL] knob and press it when the desired item is displayed.

Select "Settings" > "DISP & ILLUMI" > "Display Select" > "Type Select" > 5-line display mode or 3-line display mode or iPod-like display mode.

### 4 Select the setting item to adjust

Turn the [VOL] knob and press it when the desired item is displayed.

Display	Setting
"Display Select"	
"Type Select"	Selects from 5-line display mode, 3-line display mode, or iPod-like display mode.
"Side Select"	Sets the source display. Text/ Icon/ Disappear
"Text Select"	Sets the text display. 1. Turn the [VOL] knob to select the text display part The selected text display part blinks. 2. Press the [◀◀] or [▶▶] button to select the text
"Status"	Sets the Status display of the 5-line display mode. Appear/ Disappear

( \_ : Factory setting)

### 5 Make a setting

Press the [◀◀] or [▶▶] button.

### 6 Exit Menu List mode

Press the [MENU] button for at least 1 second, and then press it again briefly.

## Text Display Selection

### In FM Tuner source

KDC-X994/KDC-X794 : 5-line display mode

Frequency & Program Service name ("Frequency/PS")	Radio text ("Radio Text")
Song title* ("Song Title")	Spectrum analyzer & Clock ("Speana/Clock")
Artist name* ("Artist Name")	Date ("Date")
Station name* ("Station Name")	Blank ("Blank")
Radio text plus* ("Radio Text Plus")	

\* Information of Radio text plus is displayed.

KDC-X994/KDC-X794 : 3-line display mode

Frequency & Program Service name ("Frequency/PS")	Radio text ("Radio Text")
Song title & Artist name* ("Title/Artist")	Spectrum analyzer & Clock ("Speana/Clock")
Station name* ("Station Name")	Date ("Date")
Radio text plus* ("Radio Text Plus")	Blank ("Blank")

\* Information of Radio text plus is displayed.

KDC-BT945U/KDC-MP745U

Frequency ("Frequency")	Date ("Date")
Spectrum analyzer & Clock ("Speana/Clock")	Blank ("Blank")

### In AM Tuner source

Frequency ("Frequency")	Date ("Date")
Spectrum analyzer & Clock ("Speana/Clock")	Blank ("Blank")

### In USB/ iPod/ Audio file source

5-line display mode

Song title ("Song Title")	Play time bar ("Time Bar") : iPod only
Album name ("Album Name")	Spectrum analyzer & Clock ("Speana/Clock")
Artist name ("Artist name")	Date ("Date")
Folder name ("Folder name")	Blank ("Blank")
File name ("File name")	
Play time ("P-Time")	

3-line display mode

Title & Artist ("Artist/Title")	Play time bar ("Time Bar") : iPod only
Album & Artist ("Artist/Album")	Spectrum analyzer & Clock ("Speana/Clock")
Folder name ("Folder name")	Date ("Date")
File name ("File name")	Blank ("Blank")
Play time ("P-Time")	

iPod-like display mode

Song title ("Song Title")	Artist name ("Artist name")
Album name ("Album Name")	Blank ("Blank")

## In Music CD source

Disc title ("Disc title")	Spectrum analyzer & Clock ("Speana/Clock")
Track title ("Track title")	Date ("Date")
Play time ("P-Time")	Blank ("Blank")

## In Auxiliary input source

Source name ("Source Name")	Date ("Date")
Spectrum analyzer & Clock ("Speana/Clock")	Blank ("Blank")

## In Standby

Source name ("Source Name")	Clock ("Clock")
Date ("Date")	Blank ("Blank")

## In Bluetooth audio source (KDC-X994 /KDC-BT945U only)

### 5-line display mode

Bluetooth audio ("Source Name")	Spectrum analyzer & Clock ("Speana/Clock")
Song title ("Song Title")	Date ("Date")
Artist name ("Artist name")	Blank ("Blank")
Album name ("Album Name")	

### 3-line display mode

Bluetooth audio ("Source Name")	Spectrum analyzer & Clock ("Speana/Clock")
Title & Artist ("Artist/Title")	Date ("Date")
Album & Artist ("Artist/Album")	Blank ("Blank")

## In Disc changer source (Optional)

Disc title ("Disc title")	Spectrum analyzer & Clock ("Speana/Clock")
Track title ("Track title")	Date ("Date")
Play time ("P-Time")	Blank ("Blank")

## In HD Radio source (Optional)

### 5-line display mode

Frequency ("Frequency")	Spectrum analyzer & Clock ("Speana/Clock")
Station name ("Station Name")	Date ("Date")
Song Title ("Song Title")	Blank ("Blank")
Album name ("Album Name")	
Artist name ("Artist Name")	

### 3-line display mode

Frequency ("Frequency")	Spectrum analyzer & Clock ("Speana/Clock")
Station name ("Station Name")	Date ("Date")
Artist name & Song Title ("Artist name/Song Title")	Blank ("Blank")
Artist name & Album name ("Artist name/Album name")	

## In SIRIUS/ SAT/ XM source (Optional)

### 5-line display mode

Channel Name ("Channel Name" / "CHANNEL NAME")	Category Name ("Category Name" / "CATEGORY")
Song Title ("Song Title" / "SONG TITLE")	Channel Number ("Channel Number" / "CHANNEL NUMBER")
Artist name ("Artist name" / "ARTIST NAME")	Spectrum analyzer & Clock ("Speana/Clock")
Composer name ("Composer name") : SIRIUS/SAT only	Date ("Date")
	Blank ("Blank")

### 3-line display mode

Channel Name ("Channel Name" / "CHANNEL NAME")	Channel Number ("Channel Number" / "CHANNEL NUMBER")
Artist name & Song Title ("Artist name/Song Title" / "NAME/TITLE")	Spectrum analyzer & Clock ("Speana/Clock")
Category Name ("Category Name" / "CATEGORY")	Date ("Date")
	Blank ("Blank")



- If the selected display item does not have any information, alternative information is displayed.
- Some items cannot be selected depending on the display type and row.
- When selecting "Folder name" while playing with iPod, names will be displayed depending on currently selected browsing items.
- If the iPod Control by Hand Mode is set to on while playing the iPod, "iPod by Hand Mode" is displayed.
- If all characters cannot be displayed while playing with iPod, the file number in the list is displayed.

Information	Display
Music title	"TITLE****"
Folder name	"FLD****"
File name	"FILE****"

# Display Settings

## Customization of Spectrum Analyzer Display Mode

You can customize the display of the Spectrum analyzer display mode.

### 1 Select the source

Press the [SRC] button. Turn the [VOL] knob and press it when the desired item is displayed.

⚠ SRC Select mode 2: Pressing the [SRC] button repeatedly switches source.

### 2 Enter Menu List mode

Press the [MENU] button.

### 3 Enter the Display Setting mode and select the Spectrum analyzer display mode

Turn the [VOL] knob and press it when the desired item is displayed.

Select "Settings" > "DISP & ILLUMI" > "Display Select" > "Type Select" > Spectrum analyzer display mode.

### 4 Select the setting item to adjust

Turn the [VOL] knob and press it when the desired item is displayed.

Display	Setting
"Display Select"	
"Type Select"	Selects the Spectrum analyzer display mode.
"Graphic Select"	Changes the display of the Spectrum analyzer display mode.
"Text Select"	Sets the text display.

### 5 Make a setting

Press the [◀◀] or [▶▶] button.

### 6 Exit Menu List mode

Press the [MENU] button for at least 1 second, and then press it again briefly.

Function of KDC-X994

## Illumination Color Selection

Selecting the Illumination Color of the panel.

### 1 Enter Menu List mode

Press the [MENU] button.

### 2 Enter Illumination color selection mode

Turn the [VOL] knob and press it when the desired item is displayed.

Select "Settings" > "DISP & ILLUMI" > "Color Select".

### 3 Select the place where you want to set the Illumination Color

Turn the [VOL] knob and press it when the desired item is displayed.

Place	Display
Display and key	"All"
Display	"Display"
Key	"Key"

### 4 Select the Illumination Color

Turn the [VOL] knob and press it when the desired item is displayed.

Select the color from "Variable Scan"/"Color1" — "Color 10"/"User".

### Creating "User" color

You can create your original color during the selection from "Color1" — "Color10."

The color you created can be called when you select "User".

#### 1. Press the [VOL] knob for at least 1 second.

Enter the detail color adjustment mode.

#### 2. Set the color.

Operation type	Operation
To select the color to adjust. (red, green, or blue)	Press the [◀◀] or [▶▶] button.
To adjust color. (Range: 0 – 9)	Turn the [VOL] knob.

#### 3. Press the [VOL] knob.

Exit the detail color adjustment mode.

### 5 Exit Menu List mode

Press the [MENU] button for at least 1 second, and then press it again briefly.

## Auxiliary Input Display Setting

---

Selecting the display when changing to Auxiliary input source.

### 1 Select the AUX source

Press the [SRC] button. Turn the [VOL] knob and press it when the desired item is displayed.

Select the "AUX" display.

🔗 SRC Select mode 2: Pressing the [SRC] button repeatedly switches source.

### 2 Enter Menu List mode

Press the [MENU] button.

### 3 Enter Auxiliary input display setting mode

Turn the [VOL] knob and press it when the desired item is displayed.

Select "Settings" > "AUX Name Set".

### 4 Select the Auxiliary input display

Turn the [VOL] knob.

Select "AUX", "DVD", "PORTABLE", "GAME", "VIDEO", or "TV"

### 5 Exit Menu List mode

Press the [MENU] button for at least 1 second, and then press it again briefly.



- The Auxiliary input display can be set only when the built-in auxiliary input or the auxiliary input of optional KCA-S220A is used. On the KCA-S220A, "AUX EXT" is displayed by default.
- AUX source is initially set to "OFF". Before display setting, set "Built in AUX" described in <Initial Settings> (page 34) to "ON".

# Clock and Other Functions

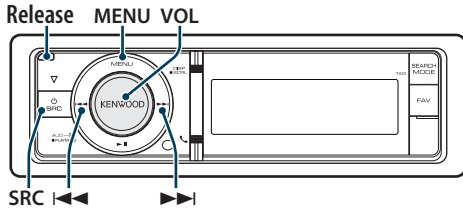

## Clock and Date Adjustment

You can adjust the clock and date.

Display	Overview
"Settings"	
"Clock & Date"	
"Clock Adjust"	Sets the clock.
"Time Synchronized"	Synchronizing the RDS station time data and this unit's clock. (KDC-X994/ KDC-X794 only) "OFF"/"ON"
"Date Adjust"	Sets the date.
"Date Mode Select"	Sets the date display mode.

### 1 Enter Menu List mode

Press the [MENU] button.

### 2 Select RDS's automatic time adjustment (KDC-X994/ KDC-X794 only)

Turn the [VOL] knob and press it when the desired item is displayed.

Select "Settings" > "Clock & Date" > "Time Synchronize" > "ON" or "OFF".

When selected "OFF", proceed to step 3.

When selected "ON", proceed to step 5.

### 3 Enter Clock adjustment mode

Turn the [VOL] knob and press it when the desired item is displayed.

Select "Settings" > "Clock & Date" > "Clock Adjust".

### 4 Adjusting Clock

1. Turn the [VOL] knob to set the hours.
2. Press the [▶▶] button.
3. Turn the [VOL] knob to set the minutes.
4. Press the [VOL] knob.

### 5 Enter Date adjustment mode

Turn the [VOL] knob and press it when the desired item is displayed.

Select "Date Adjust".

### 6 Adjusting Date

1. Turn the [VOL] knob to adjust the year.

2. Press the [▶▶] button.
3. Turn the [VOL] knob to adjust the month.
4. Press the [▶▶] button.
5. Turn the [VOL] knob to adjust the day.
6. Press the [VOL] knob.

### 7 Enter Date format mode

Turn the [VOL] knob and press it when the desired item is displayed.

Select "Date Mode Select".

### 8 Select Date format

Turn the [VOL] knob and press it when the desired item is displayed.

Select from 7 types.

### 9 Exit Menu List mode

Press the [MENU] button for at least 1 second, and then press it again briefly.

## Initial Settings

You can select following Initial Setting items.

### 1 Select the Standby

Press the [SRC] button. Turn the [VOL] knob and press it when the desired item is displayed.

Select the "STANDBY" display.

➡ SRC Select mode 2: Pressing the [SRC] button repeatedly switches source.

### 2 Enter Menu List mode

Press the [MENU] button.

### 3 Enter Initial Setting mode

Turn the [VOL] knob and press it when the desired item is displayed.

Select "Initial Settings".

### 4 Select the setting item to adjust

Turn the [VOL] knob.

Display	Overview
"Initial Settings"	
"SRC Select"	Sets the source selection method. "Settings 1"/"2"
"Beep"	Setting the operation check sound (beep sound) ON/OFF "OFF"/"ON"
"Menu Language"	You can select the display language for the Menu list item. "English"/"Français"/"Español"

"Built in AUX"	When this is set to ON, AUX source can be selected. "ON": Allows AUX source to be selected. Use this setting when the built-in AUX terminal is connected to the external equipment all the time. "OFF": Disable AUX source selection. Use this setting when the built-in AUX terminal is not used.
"Forced CD-DA"	Sets the method for reading CD. "Settings 1": Automatically distinguishes between audio file disc and music CD when playing disc. "Settings 2": Forces playing as music CD.
"Favorite Delete"	Deletes Favorite Preset Memory. Refer to <Favorite Preset Memory Delete> (page 46).
"Built in AMP"	Selecting "OFF" turns off the built-in amplifier. Turning off the built-in amplifier improves the quality of the sound from Preout. "OFF"/"ON"
"DSI"	DSI (Disabled System Indicator) of the unit blinks when the faceplate is removed. "OFF"/"ON"

( \_ : Factory setting)

## 5 Make a setting

- When the "PUSH" icon is displayed (at the right edge of the display)  
Turn the [VOL] knob to select a setting value, and then press the [VOL] knob.
- When the "PUSH" icon is not displayed  
Press the [◀] or [▶] button to select a setting value.

## 6 Exit Menu List mode

Press the [MENU] button for at least 1 second, and then press it again briefly.

## Demonstration mode Setting

Turning the demonstration mode ON/OFF.

- 1 Enter Menu List mode**  
Press the [MENU] button.
- 2 Enter Demonstration mode setting**  
Turn the [VOL] knob and press it when the desired item is displayed.  
Select "DEMO Mode".
- 3 Set the Demonstration mode**  
Turn the [VOL] knob and press it when the desired item is displayed.  
Select "ON" or "OFF".
- 4 Exit Menu List mode**  
Press the [MENU] button.

Function of KDC-X794/ KDC-MP745U

## Muting volume upon reception of Phone call

The audio system automatically mutes when a call comes in.

### When a call comes in

"CALL" is displayed.  
The audio system pauses.

### Listening to the audio during a call

Press the [SRC] button.  
The "CALL" display disappears and the audio system comes back ON.

### When the call ends

Hang up the phone.  
The "CALL" display disappears and the audio system comes back ON.



- To use the TEL Mute feature, you need to hook up the MUTE wire to your telephone using a commercial telephone accessory. Refer to <Connecting Wires to Terminals> (page 70).

# Clock and Other Functions

## Theft Deterrent Faceplate

The faceplate of the unit can be detached and taken with you, helping to deter theft.

### Removing the Faceplate

**1 Press the Release button.**

Drop open the faceplate.

**2 Drawing the faceplate to left side pull it to forward and remove it.**

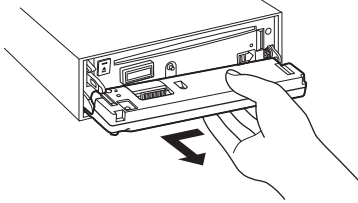

- The faceplate is a precision piece of equipment and can be damaged by shocks or jolts.
- Keep the faceplate in its faceplate case while detached.
- Do not expose the faceplate (and the faceplate case) to direct sunlight or excessive heat or humidity. Also avoid places with too much dust or the possibility of water splashing.

### Reattaching the Faceplate

**3 Align the shaft on the unit with the depression on the faceplate.**

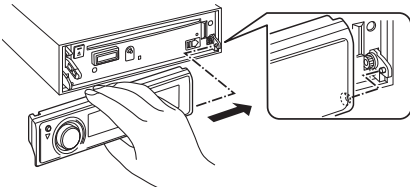

**4 Push the faceplate in until it clicks.**

The faceplate is locked in place, allowing you to use the unit.

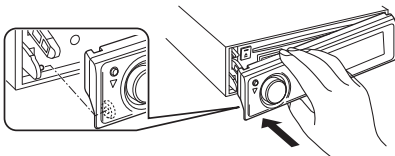



# Audio Adjustments

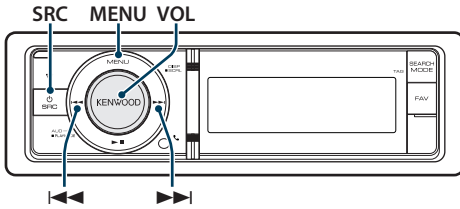

## Audio Control

You can adjust following Audio Setting items.

Display	Overview
"SubWoofer Level"	You can set subwoofer level. "–15" — "0" — "+15"
"DSP Set"	"Bypass": Disables the DSP function. "Through": Enables the DSP function.
"Equalizer"	Sets the sound quality. - Preset Equalizer curve Select (page 39). - Manual Equalizer Control (page 39).
"Bass Boost"	Sets the Bass Boost level in two steps. "OFF"/"Step1" — "2"
"HIGHWAY-SOUND"	Compensates the low volume or bass sound being lost by road noises to make vocal sound clearer. "OFF"/"Step1"/"2"/"3"
"Supreme+"	Turns ON/OFF the Supreme plus function. Can be set while Music CD source, Audio file source of USB and iPod source. "ON"/"OFF"
"Position"	Compensates the sound environment in accordance with the listening position. - Listening Position Selection (page 40). - Listening Position Fine Adjustments (page 40).
"Balance"	Adjusts left/right speaker balance. (Left) "L15" — "0" — "R15" (Right)
"Fader"	Adjusts front/rear speaker balance. (Rear) "R15" — "0" — "F15" (Front)
"2Zone Rear Volume"	Refer to <Dual Zone System> (page 40).
"SubWoofer"	Turns on/off the subwoofer output. "ON"/"OFF"
"Detailed Setup"	
"Car Type"	To get clear sound, set the sound environment according to the location and size of physically installed speakers with reference to the followings:
"Speaker"	
"Car Type Adjust"	
"X'Over"	- Car Type Selection (page 42). - Speaker Setting (page 42). - Car Type Fine Adjustments (page 43). - X'Over Setting (page 44).
"Volume offset"	Sets each source's volume as a difference from the basic volume. "–8" — "±0" (AUX: "–8" — "+8")

"2Zone"	Sets the Dual Zone System. - Dual Zone System (page 40).
"2Zone Select"	
"Preset"	Sets the audio preset. - Audio Preset Memory (page 44). - Audio Preset Recall (page 45).

( \_ : Factory setting)

### 1 Select the source

Press the [SRC] button. Turn the [VOL] knob and press it when the desired item is displayed.

Select a source other than "STANDBY".

↻ SRC Select mode 2: Pressing the [SRC] button repeatedly switches source.

### 2 Enter Audio Control mode

Press the [VOL] knob.

### 3 Select the setting item to adjust

Turn the [VOL] knob and press it when the desired item is displayed.

### 4 Make a setting

Press the [◀◀] or [▶▶] button to select a setting value, and then press the [VOL] knob.

### 5 Exit Audio Control mode

Press the [MENU] button for at least 1 second, and then press it again briefly.

### Remarks

#### • DSP Set

When "DSP Set" is set to "BYPASS", the DSP function is disabled, and the colored items can not be set.

#### • HIGHWAY-SOUND

Increases the volume of faintest sound being lost by road noises to make the sound more audible. Additionally, it accentuates bass sound being lost by road noises to make the bass sound more dynamic.

#### • Supreme+ (Supreme Plus)

Technology to extrapolate and supplement with proprietary algorithm, the high-frequency range that is cut off when encoding. The bass and vocal sound that are cut off by encoding are supplemented for the reproduction of natural sound quality. Supplementing is optimized by compression format (AAC, MP3 or WMA) and processed according to bit rate. The effect is negligible with music that is encoded at high bit rate, variable bit rate or has minimal high frequency range. The bass and vocal sound of Music CD/ iPod is also supplemented.

#### • Dual Zone System

Main source and sub source (Auxiliary input) output Front channel and Rear channel separately.

## Preset Equalizer curve Select

You can select following Equalizer curve.

Display	Equalizer curve
"Natural"	Natural
"User"	User*
"Rock"	Rock
"Pops"	Pops
"Easy"	Easy
"Top 40"	Top 40
"Jazz"	Jazz
"Game"	Game
"iPod"	iPod (During iPod source only)

\* The Equalizer curve set in the section <Manual Equalizer Control> is recalled.

( \_\_ : Factory setting)

### 1 Select the source

Press the [SRC] button. Turn the [VOL] knob and press it when the desired item is displayed.

Select a source other than "STANDBY".

↻ SRC Select mode 2: Pressing the [SRC] button repeatedly switches source.

### 2 Enter Audio Control mode

Press the [VOL] knob.

### 3 Enter Preset Equalizer mode

Turn the [VOL] knob and press it when the desired item is displayed.

Select "Equalizer" > "Preset Equalizer".

### 4 Select the Equalizer curve

Press the [◀◀] or [▶▶] button.

↻ Select the iPod Equalizer curve

You can select from 22 Equalizer curve types for iPod when "iPod" is selected.

#### 1. Enter iPod Equalizer mode

Press the [VOL] knob.

#### 2. Select the iPod Equalizer curve

Press the [◀◀] or [▶▶] button and press it when the desired item is displayed.

### 5 Exit Audio Control mode

Press the [MENU] button for at least 1 second, and then press it again briefly.



- You can select for each source.

## Manual Equalizer Control

You can adjust following Equalizer Control items.

### KDC-X994/ KDC-X794

Band	Item	Range
"BAND1" (62.5 Hz)	"GAIN" Band level	-9 — +9 dB
	"EFFECT" Bass Effect	"ON"/"OFF"
"BAND2" (250 Hz)	"GAIN" Band level	-9 — +9 dB
	"BAND3" (1 kHz)	"GAIN" Band level
"BAND4" (4 kHz)	"GAIN" Band level	-9 — +9 dB
	"BAND5" (16 kHz)	"GAIN" Band level

( \_\_ : Factory setting)

### KDC-BT945U/ KDC-MP745U

Band	Item	Range
"BAND1" (60/ 100/ 160/ 250/ 400 Hz)	"GAIN" Band level	-9 — +9 dB
	"Q" Quality	0.25/ 0.5/ <u>1.0</u> / 2.0
"BAND2" (630/ 1k/ 1.6k/ 2.5k Hz)	"GAIN" Band level	-9 — +9 dB
	"Q" Quality	0.25/ 0.5/ <u>1.0</u> / 2.0
"BAND3" (4k/ 6.3k/ 10k/ <u>16k</u> kHz)	"GAIN" Band level	-9 — +9 dB
	"Q" Quality	0.25/ 0.5/ <u>1.0</u> / 2.0

( \_\_ : Factory setting)

### 1 Select the source

Press the [SRC] button. Turn the [VOL] knob and press it when the desired item is displayed.

Select a source other than "STANDBY".

↻ SRC Select mode 2: Pressing the [SRC] button repeatedly switches source.

### 2 Enter Audio Control mode

Press the [VOL] knob.

### 3 Enter Manual Equalizer Control mode

Turn the [VOL] knob and press it when the desired item is displayed.

Select "Equalizer" > "Manual Equalizer".

### 4 Select the item you want to set

Operation type	Operation
Selects the item.	Turn the [VOL] knob.
Adjust each item.	Press the [◀◀] or [▶▶] button.
Set the value	Press the [VOL] button.

### 5 Exit Audio Control mode

Press the [MENU] button for at least 1 second, and then press it again briefly.



- When "iPod" is selected in the section <Preset Equalizer curve Select> (page 39), Manual Equalizer Control is disabled.
- You can select for each source.

# Audio Adjustments

## Listening Position Selection

The sound environment can be compensated in accordance with the selected position. According to the listening position, select the position from the following settings.

Compensation seat	Display
Not compensating.	"ALL"
Front-Left seat	"Front-Left"
Front-Right seat	"Front-Right"
Front seat	"Front"

( \_\_ : Factory setting)

### 1 Select the source

Press the [SRC] button. Turn the [VOL] knob and press it when the desired item is displayed.

Select a source other than "STANDBY".

➤ SRC Select mode 2: Pressing the [SRC] button repeatedly switches source.

### 2 Enter Audio Control mode

Press the [VOL] knob.

### 3 Enter Preset position setting mode

Turn the [VOL] knob and press it when the desired item is displayed.

Select "Position" > "Preset Position".

### 4 Select the seat you want to compensate

Press the [◀◀] or [▶▶] button.

### 5 Exit Audio Control mode

Press the [MENU] button for at least 1 second, and then press it again briefly.

Function of KDC-X994/ KDC-X794

## Listening Position Fine Adjustments

Making fine adjustment of the value specified at Preset position selection per speaker.

### 1 Select the source

Press the [SRC] button. Turn the [VOL] knob and press it when the desired item is displayed.

Select a source other than "STANDBY".

➤ SRC Select mode 2: Pressing the [SRC] button repeatedly switches source.

### 2 Enter Audio Control mode

Press the [VOL] knob.

### 3 Enter Manual position setting mode

Turn the [VOL] knob and press it when the desired item is displayed.

Select "Position" > "DTA".

### 4 Select the speaker you want to set

Turn the [VOL] knob and press it when the desired value is displayed.

Item	Setting overview
"FRONT" / "L"	Front Left speaker
"FRONT" / "R"	Front Right speaker
"REAR" / "L"	Rear Left speaker
"REAR" / "R"	Rear Right speaker
"SUBWOOFER" / "L"	Subwoofer Left
"SUBWOOFER" / "R"	Subwoofer Right
"INITIAL"	Initialize the setting values.

### 5 Set the value

Press the [◀◀] or [▶▶] button.

Adjust between 0 and 5.58 feet.

Press the [VOL] knob for at least 1 second if you want to execute the "INITIAL".

### 6 Exit Audio Control mode

Press the [MENU] button for at least 1 second, and then press it again briefly.

## Dual Zone System

Main source and sub source (Auxiliary input) output Front channel and Rear channel separately.

Display	Overview
"2Zone Rear Volume"*1	Adjust the volume of Rear channel. "0" — "35"
"Detailed Setup"	
"2Zone"	Sets the Dual Zone System. "OFF" / "ON"
"2Zone Select"*1	Specifies the destination of sub source sound when the Dual Zone function is turned on. "Rear" / "Front"

\*1 The Dual Zone System is set to "ON".

( \_\_ : Factory setting)

### 1 Select the source

Press the [SRC] button. Turn the [VOL] knob and press it when the desired item is displayed.

Select a source other than "STANDBY".

➤ SRC Select mode 2: Pressing the [SRC] button repeatedly switches source.

### 2 Enter Audio Control mode

Press the [VOL] knob.

### 3 Turn the [VOL] knob and press it when the desired item is displayed.

Select "Detailed Setup".

### 4 Select the item you want to set

Turn the [VOL] knob and press it when the

desired item is displayed.

## 5 Exit Audio Control mode

Press the [MENU] button for at least 1 second, and then press it again briefly.



- Select Main source by [SRC] button.
- Adjust the volume of Front channel by [VOL] knob.
- The Audio Control has no effect on sub source.
- There are following limitations when Dual Zone System is enabled.
  - There is no output from the subwoofer.
  - "Fader", "Subwoofer Level" of <Audio Control> (page 38) and DSP function are not available.
- The Bluetooth audio source can be set exclusively to the front speaker. Set "2Zone Select" to "Rear".

## DSP Setup

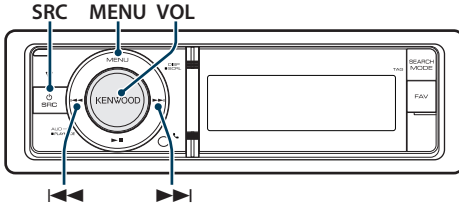

### Car Type Selection

You can compensate the delay of the sound arrival time by selecting your environment from the following car types.

Display	Overview
"OFF"	Not compensating.
"Compact"	Compact car
"Full size car"	Full size car
"Wagon"	Station wagon
"Minivan"	Minivan
"SUV"	Sport-utility vehicle
"Minivan (Long)"	Long Minivan

( \_ : Factory setting)

#### 1 Select the source

Press the [SRC] button. Turn the [VOL] knob and press it when the desired item is displayed.

Select a source other than "STANDBY".

⚙️ SRC Select mode 2: Pressing the [SRC] button repeatedly switches source.

#### 2 Enter Audio Control mode

Press the [VOL] knob.

#### 3 Enter Cabin select mode

Turn the [VOL] knob and press it when the desired item is displayed.

Select "Detailed Setup" > "Car Type".

#### 4 Select the car type

Press the [◀◀] or [▶▶] button.

#### 5 Set the value

Press the [VOL] button.

#### 6 Exit Audio Control mode

Press the [MENU] button for at least 1 second, and then press it again briefly.



- You can compensate the distances in more details by using <Car Type Fine Adjustments> (page 43) function.

## Speaker Setting

The speaker X'Over is automatically set when the position and size of each speaker are selected from the following items.

Speaker	Item	Range
"FRONT"	"SIZE"	Speaker Size Front KDC-X994/ KDC-X794: "O.E.M.", "4inch", "5inch", "6 1/2inch", "6 3/4inch", "7inch", "4x6", "5x7", "6x8", "6x9", "7x10" KDC-BT945U/ KDC-MP745U: "Small", "Medium", "Large"
	"LOCATION"	Speaker Location Front "Door", "On Dash", "Under Dash"
	"TWEETER"	Speaker Size Tweeter "None", "Use"
"REAR"	"SIZE"	Speaker Size Rear KDC-X994/ KDC-X794: "None", "O.E.M.", "4inch", "5inch", "6 1/2inch", "6 3/4inch", "7inch", "4x6", "5x7", "6x8", "6x9", "7x10" KDC-BT945U/ KDC-MP745U: "None", "Small", "Medium", "Large"
	"LOCATION"	Speaker Location Rear • "Door", "Rear Deck" • "2nd Row", "3rd Row" (Car Type: "Minivan", "Minivan (Long)")
"SUB W"	"SIZE"	Speaker Size Subwoofer KDC-X994/ KDC-X794: "None", "6 1/2inch", "8inch", "10inch", "12inch", "15inch Over" KDC-BT945U/ KDC-MP745U: "None", "Small", "Large"

( \_ : Factory setting)

#### 1 Select the source

Press the [SRC] button. Turn the [VOL] knob and press it when the desired item is displayed.

Select a source other than "STANDBY".

⚙️ SRC Select mode 2: Pressing the [SRC] button repeatedly switches source.

#### 2 Enter Audio Control mode

Press the [VOL] knob.

#### 3 Enter Speaker setting mode

Turn the [VOL] knob and press it when the desired item is displayed.

Select "Detailed Setup" > "Speaker".

#### 4 Select the item you want to set

Operation type	Operation
Selects the item.	Turn the [VOL] knob.
Adjust each item.	Press the [◀◀] or [▶▶] button.
Set the value	Press the [VOL] button.

## 5 Exit Audio Control mode

Press the [MENU] button for at least 1 second, and then press it again briefly.

## Car Type Fine Adjustments

Adjusting fine tuning of the speaker position compensation value specified at <Car Type Selection> (page 42).

Display	Item	Range
"Front"	Front speaker	0 – 14.44 feet
"Rear"	Rear speaker	0 – 14.44 feet
"SW"	Subwoofer	0 – 14.44 feet

( \_ : Factory setting)

### 1 Select the source

Press the [SRC] button. Turn the [VOL] knob and press it when the desired item is displayed.

Select a source other than "STANDBY".

🔊 SRC Select mode 2: Pressing the [SRC] button repeatedly switches source.

### 2 Enter Audio Control mode

Press the [VOL] knob.

### 3 Enter Car Type Adjustment mode

Turn the [VOL] knob and press it when the desired item is displayed.

Select "Detailed Setup" > "Car Type Adjust".

### 4 Select the item you want to set

Operation type	Operation
Selects the item.	Turn the [VOL] knob.
Adjust each item.	Press the [◀◀] or [▶▶] button.
Set the value	Press the [VOL] button.

The settings of the delay time are automatically identified and compensated by specifying the distances of each speaker from the center of the vehicle interior.

- 1 Set the front and rear positions and the height of the reference point to the position of the ears of the person sitting in the front seat, and set the right and left positions to the center of the vehicle interior.
- 2 Measure the distances from the reference point to the speakers.
- 3 Calculate the distance difference in accordance with the farthest speaker.

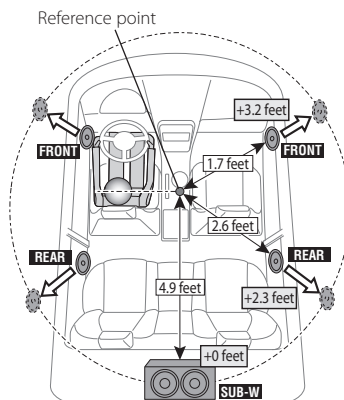

### 5 Exit Audio Control mode

Press the [MENU] button for at least 1 second, and then press it again briefly.

# DSP Setup

## X'Over Setting

Fine adjusting the following setting values corresponding to the X'Over values set in the section <Speaker Setting> (page 42).

Display	Item	Range
"X'Over"		
"Front"	"FC"	Front High Pass Filter Through, 30*, 40, 50*, 60, 70, 80, 90*, 100, 120, 150, 180, 220, 250* (Hz)
	"SLOPE"	Front High Pass Slope -6, -12, -18, -24 dB/Oct
"Rear"	"FC"	Rear High Pass Filter Through, 30*, 40, 50*, 60, 70, 80, 90*, 100, 120, 150, 180, 220, 250* (Hz)
	"SLOPE"	Rear High Pass Slope -6, -12, -18, -24 dB/Oct
"SubWoofers"	"FC"	Subwoofer Low Pass Filter 30*, 40, 50*, 60, 70, 80, 90*, 100, 120, 150, 180, 220, 250*, Through (Hz)
	"SLOPE"	Subwoofer Slope -6, -12, -18, -24 dB/Oct
	"PHASE"	Subwoofer Phase Reverse (180°)/ Normal (0°)

( \_ : Factory setting)

\* Function of KDC-X994/ KDC-X794

### 1 Select the source

Press the [SRC] button. Turn the [VOL] knob and press it when the desired item is displayed.

Select a source other than "STANDBY".

🔊 SRC Select mode 2: Pressing the [SRC] button repeatedly switches source.

### 2 Enter Audio Control mode

Press the [VOL] knob.

### 3 Enter X'Over setting mode

Turn the [VOL] knob and press it when the desired item is displayed.

Select "Detailed Setup" > "X'Over".

### 4 Select the speaker you want to set

Turn the [VOL] knob and press it when the desired item is displayed.

Select "Front", "Rear", or "SubWoofers".

### 5 Select the item you want to set

Operation type	Operation
Selects the item.	Turn the [VOL] knob.
Adjust each item.	Press the [◀◀] or [▶▶] button.
Set the value	Press the [VOL] button.

**6 Repeat steps 3 to 4 to complete the X'Over settings.**

### 7 Exit Audio Control mode

Press the [MENU] button for at least 1 second, and then press it again briefly.

## Audio Preset Memory

Registering the value setup by Sound Control.

### 1 Setup Sound Control

Refer to the following operations to setup the Sound Control.

- Car Type Selection (page 42)
- Speaker Setting (page 42)
- Car Type Fine Adjustments (page 43)
- X'Over Setting (page 44)
- Manual Equalizer Control (page 39)
- Listening Position Selection (page 40)
- Listening Position Fine Adjustments (page 40)

### 2 Enter Audio preset memory mode

Turn the [VOL] knob and press it when the desired item is displayed.

Select "Detailed Setup" > "Preset" > "Memory".

### 3 Select the number to put in the memory

Turn the [VOL] knob and press it when the desired item is displayed.

Select a preset number.

### 4 Turn the [VOL] knob and press it when the desired item is displayed.

Select "YES".

Select "YES".

"Memory Completed" is displayed.

### 5 Exit Audio Control mode

Press the [MENU] button for at least 1 second, and then press it again briefly.



- Register 6 patterns of Audio Preset Memory.
- Preset number "1":  
When you press the Reset, all the sources will be the setting value which is registered.
- Preset number "1" and "2":  
The memory cannot be erased by the Reset button.
- This function cannot be registered when the iPod Equalizer set in <Preset Equalizer curve Select> (page 39).

## Audio Preset Recall

---

Recalling the sound setup registered by [<Audio Preset Memory>](#) (page 44).

### 1 Select the source

Press the [SRC] button. Turn the [VOL] knob and press it when the desired item is displayed.

Select a source other than "STANDBY".

 SRC Select mode 2: Pressing the [SRC] button repeatedly switches source.

### 2 Enter Audio preset recall mode

Turn the [VOL] knob and press it when the desired item is displayed.

Select "Detailed Setup" > "Preset" > "Recall".

### 3 Select the number to recall in the memory

Turn the [VOL] knob and press it when the desired item is displayed.

Select preset number.

### 4 Turn the [VOL] knob and press it when the desired item is displayed.

Select "YES".

"Recall Completed" is displayed.

### 5 Exit Audio Control mode

Press the [MENU] button for at least 1 second, and then press it again briefly.



- The "User" of [<Preset Equalizer curve Select>](#) (page 39) is changed to the value which was recalled.
- The Equalizer curve is changed to the value which was recalled by the selected source.

# Favorite Control

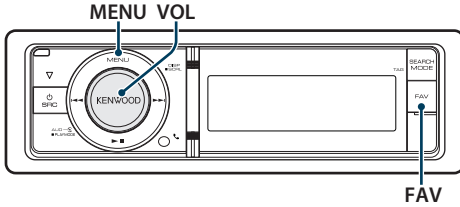

## Favorite Preset Memory

Registering the operation procedure to select your favorite broadcast station or iPod Playlists/ Artists, etc.

### 1 Display a favorite item

Source	Registerable items
TUNER/SIRIUS/XM/HD	Frequency or channel
iPod	Search item such as Playlists/ Artists/ Albums, etc.
Menu list Setting	Menu list Setting item
Audio control	Audio control item
Hands-free phone	Telephone number retrieval.

"[FAV]" is displayed when the operation procedure can be registered.

### iPod setting

The desired list in the first hierarchy can be registered.

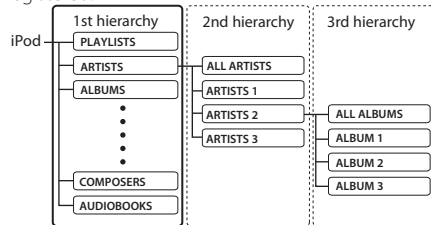

### 2 Enter Favorite Preset Memory mode

Press the [FAV] button for at least 1 second.

### 3 Select the number to put in the memory

Turn the [VOL] knob.

### 4 Put the Favorite Preset in the memory

Press the [VOL] knob.

### Canceling the Favorite Preset Memory mode

Press the [FAV] button.



- Registering the operation procedure to an existing preset number overwrites the existing procedure.
- Register 6 of Favorite Preset Memory.  
The memory cannot be erased by the Reset button.

- If the contents in iPod are changed after the FAVORITE registration, the list registered in this unit becomes different from that in iPod. In this case, perform the FAVORITE registration again.

## Favorite Preset Recall

Retrieving an item registered to Favorite.

### 1 Enter Favorite Preset Recall mode

Press the [FAV] button.

### 2 Select the number to recall in the Favorite memory

Turn the [VOL] knob and press it when the desired item is displayed.

Select preset number.

### Canceling the Favorite Preset Recall mode

Press the [FAV] button.



- When iPod is selected for the source, the list selection screen for Playlists/ Artists/ Albums, etc. is displayed. Songs will not be automatically played.

## Favorite Preset Memory Delete

Deleting an item registered to Favorite.

### 1 Select the Standby

Press the [SRC] button. Turn the [VOL] knob and press it when the desired item is displayed.

Select the "STANDBY" display.

⇨ SRC Select mode 2: Pressing the [SRC] button repeatedly switches source.

### 2 Enter Menu List mode

Press the [MENU] button.

### 3 Enter Favorite Preset Memory Delete mode

Turn the [VOL] knob and press it when the desired item is displayed.

Select "Initial Settings" > "Favorite Delete".

### 4 Enter Favorite Preset Memory Delete mode

Press the [VOL] knob.

### 5 Select the number you want to delete

Turn the [VOL] knob and press it when the desired item is displayed.

Select preset number.

"Delete?" is displayed.

Select "ALL" if you want to delete all.

### 6 Turn the [VOL] knob and press it when the desired item is displayed.

**Select "YES".**

"Completed" is displayed.

Exit Favorite Preset Memory Delete mode.

## Bluetooth Setup

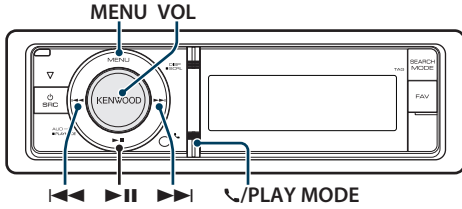

### Bluetooth Setting

You can select following Bluetooth Setting items.

#### 1 Enter Bluetooth mode

**KDC-X994 KDC-BT945U**

Press the [MENU] button.

**KDC-X794 KDC-MP745U**

Press the [PLAY MODE] button for at least 1 second.

➤ You can also select from "Settings" in Menu List mode.

#### 2 Turn the [VOL] knob and press it when the desired item is displayed. Select "BT Settings".

#### 3 Select the Menu item

Turn the [VOL] knob and press it when the desired item is displayed.

Display	Overview
"BT Settings"	
"Phone Selection"	Select a cell-phone or Bluetooth audio player connection.
"Audio Selection"	Refer to <Selecting the Bluetooth device You Wish to Connect> (page 50).
"SMS Download"	Download a short message. Refer to <Downloading the SMS> (page 54).
"SMS Inbox"	Display the received short message. Refer to <SMS (Short Message Service)> (page 54).
"Voice Tag"	Registers voice for voice recognition and voice to select the Phone number category in Phone book. - Adding a Voice Dialing Command (page 52) - Setting a Voice Command for Category (page 52)
"Detailed Setup"	Move to detailed item.
"Device Regist."	Register a Bluetooth device (pairing).
"SPCL DVC Select"	Refer to <Registering Bluetooth device> (page 49).
"Device Delete"	Cancel registration of the Bluetooth device. Refer to <Deleting a Registered Bluetooth device> (page 51).

"PIN Code Edit"	Specify the PIN code required when registering this unit using the Bluetooth device. Refer to <Registering PIN Code> (page 50).
"Auto Answer"	Answer a call automatically after lapse of the preset time interval for automatic answer. "OFF"/"0s" – "8s" – "99s"
"Bluetooth HF/ Audio"	You can specify output speakers for hands-free voice communication and Bluetooth audio sound. "FRONT": Outputs voice from the front speakers. "ALL": Outputs voice from the front and rear speakers.
"Call Beep"	You can output a beep from the speaker when a call comes in. "ON": Beep is heard. "OFF": Beep is canceled.
"BT F/W Update"	Display the version of the firmware of this unit.
"Mic Gain"*1	Adjust the sensitivity of the microphone for a telephone call. Adjust the voice of caller. Setting to "+" increases the voice volume. "-3" – "0" – "+3"
"NR Level"*1	Reduce the noises generated by surrounding environment without changing the microphone volume. Adjust the voice of caller when it is not clear. Setting to "+" increases the noise reduction. "-3" – "0" – "+3"
"Echo Cancel LV"*1	Adjust the level of echo cancellation. Setting to "+" increases the echo cancel reduction. "-2" – "0" – "+2"

( \_ : Factory setting)

\*1 Function of KDC-X994/ KDC-BT945U

#### 4 Make a setting

- When the [PUSH] icon is displayed (at the right edge of the display)

Turn the [VOL] knob to select a setting value, and then press the [VOL] knob.

- When the [PUSH] icon is not displayed  
Press the [◀] or [▶] button to select a setting value.

#### 5 Exit BT Settings mode

**KDC-X994 KDC-BT945U**

Press the [MENU] button.

**KDC-X794 KDC-MP745U**

Press the [PLAY MODE] button for at least 1 second.

#### Remarks

- "Auto Answer" (Setting the Time Interval for Automatic Answer)

This function automatically answers (responds to) a call after lapse of the preset time interval for automatic answer.  
"OFF": Does not answer the phone call automatically.  
"0": Automatically answers the phone call at once.

"1s" – "99s": Automatically answers the phone call after lapse of 1 – 99 seconds.



- If the time set in the cell-phone is shorter than that set in the unit, the former will be used.
- This function does not work for call waiting.
- **"Bluetooth HF/Audio" (Setting up the Voice Output Speakers)**  
Select the speaker which is further from the microphone in order to prevent howling or echoes.
- **"BT F/W Update" (Displaying the Firmware Version)**  
Display the version of the firmware of this unit.  
For how to update the firmware, access our web site.  
<http://www.kenwood.com/cs/ce/bt/>

## Registering Bluetooth device

To make your Bluetooth device (cell-phone) usable with this unit, you need to register it (pairing). You can register up to 5 Bluetooth devices to this unit.

### Registering from this unit

#### 1 Enter Bluetooth mode

**KDC-X994** **KDC-BT945U**  
Press the button.

**KDC-X794** **KDC-MP745U**

Press the [PLAY MODE] button for at least 1 second.

☞ You can also select from "Settings" in Menu List mode.

#### 2 Enter Bluetooth device registration mode

Turn the [VOL] knob and press it when the desired item is displayed.

Select "BT Settings" > "Detailed Setup" > "Device Regist."

Search for the Bluetooth device.

When search is completed, "Finished" is displayed.

#### 3 Select a Bluetooth device

Turn the [VOL] knob and press it when the desired item is displayed.

#### 4 "Pairing" is displayed (except KCA-BT200)

If "Pairing Success" is displayed, proceed to step 7.

If "PIN Code NG" is displayed, proceed to steps 5 to 6.

#### 5 Input the PIN code

Operation type	Operation
Select the numbers.	Turn the [VOL] knob.
Move to the next digit.	Press the [▶▶] button.
Delete the last digit.	Press the [◀◀] button.

#### 6 Transmit the PIN code

Press the [VOL] knob for at least 1 second.

If "Pairing Success" is displayed, registration is completed.

☞ If the error message appears even though the PIN code is correct, try <Registering Special Bluetooth device>.

#### 7 Return to the device list

Press the [MENU] button.

#### 8 Exit BT Settings mode

**KDC-X994** **KDC-BT945U**

Press the button.

**KDC-X794** **KDC-MP745U**

Press the [PLAY MODE] button for at least 1 second.



- This unit allows up to eight digits to be input for a PIN code. If a PIN code cannot be input from this unit, it can be input from the Bluetooth device.
- If there are 5 or more Bluetooth devices registered, you cannot register a new Bluetooth device.

### Registering Special Bluetooth device

Allow registration of a special device that cannot be registered normally (pairing).

#### 1. Select Special device registration mode

Turn the [VOL] knob and press it when the desired item is displayed.

Select "BT Settings" > "Detailed Setup" > "SPCL DVC Select".

#### 2. Enter Special device registration mode

Press the [VOL] knob for at least 1 second.  
A list is displayed.

#### 3. Select a device name

Turn the [VOL] knob and push the center when the desired device name is displayed.

If "Completed" is displayed, registration is completed.

#### 4. Go through the procedure step 3 of

<Registering from this unit> and complete the registration (pairing).

#### Canceling Special device registration mode

Press the [MENU] button for at least 1 second.



- If the device name is not in the list, select "Other Phones".

## Bluetooth Setup

### Registering PIN Code

By operating the Bluetooth device, specify the PIN code necessary for registering this unit.

#### 1 Enter Bluetooth mode

**KDC-X994** **KDC-BT945U**

Press the  button.

**KDC-X794** **KDC-MP745U**

Press the [PLAY MODE] button for at least 1 second.

☞ You can also select from “Settings” in Menu List mode.



#### 2 Enter PIN code edit mode

Turn the [VOL] knob and press it when the desired item is displayed.

Select “BT Settings” > “Detailed Setup” > “PIN Code Edit”.

The current setting of PIN code is displayed.

#### 3 Input the PIN code

Operation type	Operation
Select the numbers.	Turn the [VOL] knob.
Move to the next digit.	Press the  button.
Delete the last digit.	Press the  button.

#### 4 Register a PIN code

Press the [VOL] knob for at least 1 second.

If “Completed” is displayed, registration is completed.

#### 5 Exit BT Settings mode

**KDC-X994** **KDC-BT945U**

Press the  button.

**KDC-X794** **KDC-MP745U**

Press the [PLAY MODE] button for at least 1 second.



- By default, “0000” is specified.
- A PIN code can be specified with up to eight digits.

### Selecting the Bluetooth device You Wish to Connect

When two or more Bluetooth devices have already been registered, you need to select the Bluetooth device you wish to use.

#### 1 Enter Bluetooth mode

**KDC-X994** **KDC-BT945U**

Press the  button.

**KDC-X794** **KDC-MP745U**

Press the [PLAY MODE] button for at least 1 second.

☞ You can also select from “Settings” in Menu List mode.

#### 2 Select Bluetooth device selection mode

Turn the [VOL] knob and press it when the desired item is displayed.

##### Cell-phone

Select “BT Settings” > “Phone Selection”.

##### Audio player

Select “BT Settings” > “Audio Selection”.

#### 3 Enter Bluetooth device selection mode

Press the [VOL] knob for at least 1 second.

“(name)” is displayed.

#### 4 Select the Bluetooth device

Turn the [VOL] knob.

#### 5 Set up the Bluetooth device

Press the  or  button.

“\*(name)” or “-(name)” is displayed.

“\*”: The selected Bluetooth device is busy.

“..”: The selected Bluetooth device is on standby.

“ ” (blank): The Bluetooth device is deselected.

#### 6 Exit BT Settings mode

**KDC-X994** **KDC-BT945U**

Press the  button.

**KDC-X794** **KDC-MP745U**

Press the [PLAY MODE] button for at least 1 second.



- If a Bluetooth device is already selected, deselect it, and then select a different one.
- If you cannot select a device using the audio player, connect the device with the audio player.

## Deleting a Registered Bluetooth device

You can delete a registered Bluetooth device.

### 1 Enter Bluetooth mode

**KDC-X994** | **KDC-BT945U**

Press the  button.

**KDC-X794** | **KDC-MP745U**

Press the [PLAY MODE] button for at least 1 second.

 You can also select from "Settings" in Menu List mode.

### 2 Enter Bluetooth device deletion mode

Turn the [VOL] knob and press it when the desired item is displayed.

Select "BT Settings" > "Detailed Setup" > "Device Delete".

"(name)" is displayed.

### 3 Select the Bluetooth device

Turn the [VOL] knob.

### 4 Delete the selected Bluetooth device

Press the [VOL] knob.

### 5 Turn the [VOL] knob and press it when the desired item is displayed.

Select "YES".

"Delete" is displayed.

### 6 Exit BT Settings mode

**KDC-X994** | **KDC-BT945U**

Press the  button.

**KDC-X794** | **KDC-MP745U**

Press the [PLAY MODE] button for at least 1 second.



• When a registered cell-phone is deleted, its Phone Book, log, SMS, and voice tag are also deleted.

## Downloading the Phone Book

Download the phone book data from the cell-phone to this unit so that you can use the Phone Book of this unit.

### To download automatically

If the cell-phone supports a phone book synchronization function, the phone book is downloaded automatically after Bluetooth connection.



- Setting on the cell-phone may be required.
- If no phone book data is found in the unit even after the complete display, your cell-phone may not support automatic download of phone book data. In this case, try downloading manually.

### To download from the cell-phone manually

#### 1 By operating the cell-phone, end the hands-free connection.

#### 2 By operating the cell-phone, send the phone book data to this unit

By operating the cell-phone, download the phone book data to this unit.

- During downloading:  
"Downloading" is displayed.
- After completion of downloading:  
"Completed" is displayed.

#### 3 By operating the cell-phone, start the hands-free connection.

### To clear the downloading completion message

Press any button.



- Up to 1000 phone numbers can be registered for each registered cell-phone.
- Up to 32 digits can be registered for each phone number along with up to 50\* characters representing a name. (\* 50: Number of alphabetic alphabetical characters. Fewer characters can be input depending on the type of characters.)
- To cancel downloading of the phone book data, operate the cell-phone.

## Bluetooth Setup

Function of KDC-X794/KDC-MP745U

### Adding a Voice Dialing Command

Add a voice tag to the phone book for voice dialing. You can register up to 35 voice tags.

#### 1 Enter Bluetooth mode

Press the [PLAY MODE] button for at least 1 second.

☞ You can also select from "Settings" in Menu List mode.

#### 2 Enter Phone book name edit mode

Turn the [VOL] knob and press it when the desired item is displayed.

Select "BT Settings" > "Voice Tag" > "PB Name Edit".

#### 3 Search for the name to register

Select the name to register with reference to 4 in <Calling a Number in the Phone Book> (page 26). If a voice tag has already been registered for a name, "\*" is displayed before the name.

#### 4 Select a mode

Turn the [VOL] knob.

Display	Operation
"PB Name Regist"	Register a voice tag.
"PB Name Check"*	Play a voice tag.
"PB Name Delete"*	Delete a voice tag.
"Return"	Return to step 2.

\* Displayed only when a name for which a voice tag has been registered is selected.

#### Select "PB Name Regist" (Regist)

#### 5 Register a voice tag (first)

"Enter Voice 1" is displayed.

When a beep is heard, say a voice tag within 2 seconds.

#### 6 Confirm the voice tag (second)

"Enter Voice 2" is displayed.

When a beep is heard, say the same voice tag as that you said in step 6 within 2 seconds.

"Completed" is displayed.

#### 7 End registration

Press the [VOL] knob.

Return to step 2. You can register another voice tag continuously.



• If your voice cannot be recognized, a message is displayed. Pressing the [VOL] knob allows you to retry voice input. (page 52)

#### Select "PB Name Check" (Play)

#### 5 Press the [VOL] knob.

Play the registered voice and return to step 2.

#### Select "PB Name Delete" (Delete)

#### 5 Delete a voice tag

Press the [VOL] knob.

#### 6 Turn the [VOL] knob to select "YES", and then press the [VOL] knob.

#### Exit BT Settings mode

Press the [PLAY MODE] button for at least 1 second.



• Audio sound is not output during voice tag registration.

Function of KDC-X794/KDC-MP745U

### Setting a Voice Command for Category

Add a voice tag to the phone number category (type) for voice calling.

#### 1 Enter Bluetooth mode

Press the [PLAY MODE] button for at least 1 second.

☞ You can also select from "Settings" in Menu List mode.

#### 2 Enter Phone Number type edit mode

Turn the [VOL] knob and press it when the desired item is displayed.

Select "BT Settings" > "Voice Tag" > "PN Type Edit".

#### 3 Select the category (type) you wish to set

Turn the [VOL] knob and press it when the desired item is displayed.

Select "General", "Home", "Office", "Mobile", or "Other".

#### 4 Select a mode

Turn the [VOL] knob.

Display	Operation
"PN Type Regist"	Register a voice tag.
"PN Type Check"*	Play a voice tag.
"PN Type Delete"*	Delete a voice tag.
"Return"	Return to step 2.

\* Displayed only when a name for which a voice tag has been registered is selected.

#### 5 Register the category (type) by performing steps 5 to 7 in <Adding a Voice Dialing Command> (page 52).

## 6 Exit BT Settings mode

Press the [PLAY MODE] button for at least 1 second.



- Set the voice tag for all the 5 categories. If the voice tag is not registered for all the categories, the Phone book may not be recalled by voice command.

## SMS (Short Message Service)

### Downloading the SMS

Download the short message (SMS) arrived at the cell-phone so that it can be read on this unit.

#### 1 Enter Bluetooth mode

**KDC-X994** **KDC-BT945U**

Press the [ ] button.

**KDC-X794** **KDC-MP745U**

Press the [PLAY MODE] button for at least 1 second.

⇒ You can also select from "Settings" in Menu List mode.

#### 2 Enter SMS download mode

Turn the [VOL] knob and press it when the desired item is displayed.

Select "BT Settings" > "SMS Download".

#### 3 Start downloading

Press the [VOL] knob.

"Downloading" is displayed.

When the downloading finishes, "Completed" is displayed.

#### 4 Exit BT Settings mode

**KDC-X994** **KDC-BT945U**

Press the [ ] button.

**KDC-X794** **KDC-MP745U**

Press the [PLAY MODE] button for at least 1 second.



- The cell-phone must be able to transmit the SMS using Bluetooth. Setting on the cell-phone may be required. If the cell-phone does not support SMS function, the SMS download item in Function Control mode is not displayed.
- When the SMS is downloaded from the cell-phone, the unopened messages in the cell-phone are opened.
- The already-read and unread short messages can be respectively downloaded up to 75.

### SMS (Short Message Service)

The SMS arrived at the cell-phone is displayed on the receiver.

A newly arrived message is displayed.



- To prevent car accidents, the driver should not read the SMS while driving.

#### When a new message arrives

"SMS Received" is displayed.

The display disappears with any operations.

### Displaying the SMS

#### 1 Enter Bluetooth mode

**KDC-X994** **KDC-BT945U**

Press the [ ] button.

**KDC-X794** **KDC-MP745U**

Press the [PLAY MODE] button for at least 1 second.

⇒ You can also select from "Settings" in Menu List mode.

#### 2 Enter SMS Inbox mode

Turn the [VOL] knob and press it when the desired item is displayed.

Select "BT Settings" > "SMS Inbox".

A message list appears.

#### 3 Select a message

Turn the [VOL] knob.

Each pressing of the [DISP] button switches between telephone number or name and message reception date.

#### 4 Display the text

Press the [VOL] knob.

Turning the [VOL] knob scrolls the message.

Pressing the [VOL] knob again returns to the message list screen.

#### 5 Exit SMS Inbox mode

Press the [MENU] button.

#### 6 Exit BT Settings mode

**KDC-X994** **KDC-BT945U**

Press the [ ] button.

**KDC-X794** **KDC-MP745U**

Press the [PLAY MODE] button for at least 1 second.



- The unopened message is displayed at the beginning of the list. Other messages are displayed in the order of reception.
- The SMS that has arrived when the cell-phone is not

linked with Bluetooth cannot be displayed. Download the SMS.

- The short message cannot be displayed during downloading the SMS.

# Satellite Radio Tuner Control (Optional)

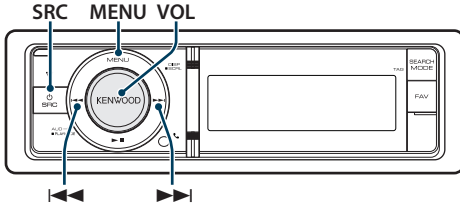

## Basic Operation

### Selecting Satellite Radio source

Press the [SRC] button. Turn the [VOL] knob and press it when the desired item is displayed.

Select the "SAT", "SIRIUS", or "XM" display.

🔊 SRC Select mode 2: Pressing the [SRC] button repeatedly switches source.



- You need to register to the service provider to receive the service by Satellite Radio. Consult the service provider if "CALL ... TO SUBSCRIBE" appears.
- The radio may take a little time to start receiving after you select the Satellite Radio source.
- If the signal reception fails, "Acquiring Signal"/ "No Signal" appears.

### Selecting the channel

Press the [◀◀] or [▶▶] button.

### Selecting the Preset Band

1. Enter Menu List mode  
Press the [MENU] button.
2. Turn the [VOL] knob and press it when the desired item is displayed.  
Select "SR1", "SR2", "SR3" or "SR4". (SIRIUS/SAT)  
Select "XM1", "XM2", "XM3" or "XM4". (XM)

## Satellite Radio Setting

You can select following Satellite Radio Setting items.

- 1 Select Satellite Radio source
- 2 Enter Menu List mode  
Press the [MENU] button.
- 3 Turn the [VOL] knob and press it when the desired item is displayed.  
Select "Settings".
- 4 Select the setting item to adjust  
Turn the [VOL] knob and press it when the desired item is displayed.

Display	Selectable setting/item
"Settings"	
"Seek Mode"	Selects the tuning mode of the radio. "Channel": Normal manual seeking control. "Preset": Search in order of the channels in the Preset memory
"ESN"	Displays the Electronic Serial Number of satellite radio. "ESN="

( \_ : Factory setting)

- 5 Make a setting  
Press the [◀◀] or [▶▶] button.
- 6 Exit Menu List mode  
Press the [MENU] button for at least 1 second, and then press it again briefly.

## Category and Channel Search

Selecting the channel and category you want to receive.

- 1 Select Satellite Radio source
- 2 Enter Menu List mode  
Press the [MENU] button.
- 3 Enter Category and Channel Search mode  
Turn the [VOL] knob and press it when the desired item is displayed.  
Select "Channel Search".
- 4 Select the Category  
Turn the [VOL] knob to select Category, and then press the [VOL] knob.
- 5 Select the Channel  
Turn the [VOL] knob to select Channel, and then press the [VOL] knob.

### Canceling Category and Channel Search mode

Press the [MENU] button for at least 1 second, and then press it again briefly.



- You cannot Channel search until the category information is acquired.

## Preset Memory

---

Putting the channel in the memory.

- 1 Select the channel you wish to store in the preset memory**
- 2 Enter Menu List mode**  
Press the [MENU] button.
- 3 Enter Preset Memory mode**  
Turn the [VOL] knob and press it when the desired item is displayed.  
Select "List & Memory".
- 4 Select the number to put in the memory**  
Turn the [VOL] knob and press [VOL] knob for at least 2 seconds when the desired item is displayed.  
Select preset number.

### Canceling the Preset Memory mode

Press the [MENU] button for at least 1 second, and then press it again briefly.



- Only the channel number is stored. Category information is not stored.

## Preset Tuning

---

Recalling the channels in the memory.

- 1 Select Satellite Radio source**
- 2 Enter Menu List mode**  
Press the [MENU] button.
- 3 Select a desired station in the memory**  
Turn the [VOL] knob and press it when the desired item is displayed.  
Select "List & Memory" > Preset number.

## Channel Scan

---

Every receivable Channel is checked for 10 seconds.

- 1 Select Satellite Radio source**
- 2 Enter Menu List mode**  
Press the [MENU] button.

### 3 Enter Channel Scan

Turn the [VOL] knob and press it when the desired item is displayed.  
Select "Channel Scan".

### 4 Start Channel Scan

Turn the [VOL] knob and press it when the desired item is displayed.  
Select "YES".

### 5 Release it when the channel you want to listen to is received

Press the [VOL] knob.

*Function of remote control*

## Direct Access Tuning

---

Entering the channel and tuning.

- 1 Select Satellite Radio source**
- 2 Enter Direct Access Tuning mode**  
Press the [DIRECT] button on the remote control.  
"----" is displayed.
- 3 Enter the channel**  
Press the number buttons.
- 4 Tune in to the entered channel**  
Press the [◀◀] or [▶▶] button.

### Canceling Direct Access Tuning

Press the [DIRECT] button on the remote control.



- If you make no button operation for 10 seconds, the Direct Access Tuning mode is automatically canceled.
- If you cannot receive any signal in the input Channel due to bad conditions on radio wave or other such problems, "Acquiring Signal"/"No Signal" appears.

## HD Radio™ Tuner Control (Optional)

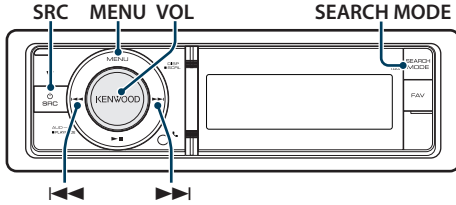

### Basic Operation

#### Selecting HD Radio source

Press the [SRC] button. Turn the [VOL] knob and press it when the desired item is displayed.

Select the "HD RADIO" display.

🔊 SRC Select mode 2: Pressing the [SRC] button repeatedly switches source.

#### Selecting the Receiving Band

1. Enter Menu List mode

Press the [MENU] button.

2. Turn the [VOL] knob and press it when the desired item is displayed.

Select "FM1", "FM2", "FM3" or "AM".

#### Selecting the Receiving station

Press the [◀◀] or [▶▶] button.

During reception of stereo stations the "ST" indicator is light up.

🔊 Details of the station selecting in operation are set in the "Seek Mode" of [<HD Radio™ Setting>](#) (page 58).

### Station Preset Memory

Putting a station in the memory.

1 Select the radio band and tune in a desired radio station you wish to store in the preset memory

2 Enter Menu List mode

Press the [MENU] button.

3 Enter Preset Memory mode

Turn the [VOL] knob and press it when the desired item is displayed.

Select "List & Memory".

4 Select the number to put in the memory

Turn the [VOL] knob and press [VOL] knob for at least 2 seconds when the desired item is displayed.

Select preset number.

#### Canceling the Preset Memory mode

Press the [MENU] button for at least 1 second, and then press it again briefly.

### Auto Memory Entry

Putting stations with good reception in the memory automatically.

1 Select the radio band you wish to store in the preset memory

2 Enter Menu List mode

Press the [MENU] button.

3 Enter Auto Memory Entry mode

Turn the [VOL] knob and press it when the desired item is displayed.

Select "Settings" > "Auto Memory".

4 Open Auto Memory Entry

Turn the [VOL] knob and press it when the desired item is displayed.

Select "YES".

When 6 stations that can be received are put in the memory, auto memory entry closes.

### Preset Tuning

Recalling the stations in the memory.

1 Select the radio band

2 Enter Menu List mode

Press the [MENU] button.

3 Select a desired station in the memory

Turn the [VOL] knob and press it when the desired item is displayed.

Select "List & Memory" > Preset number.

### HD Radio™ Setting

You can select following HD Radio Setting items.

1 Select the HD Radio source

2 Enter Menu List mode

Press the [MENU] button.

3 Turn the [VOL] knob and press it when the desired item is displayed.

Select "Settings".

4 Select the setting item to adjust

Turn the [VOL] knob and press it when the desired item is displayed.

Display	Overview
"Settings"	
"Seek Mode"	Selects the tuning mode of the radio. <b>"Auto1"</b> : Automatic search for a station. <b>"Auto2"</b> : Search in order of the stations in the Preset memory. <b>"Manual"</b> : Normal manual tuning control.
"Auto Memory"	Memorizes 6 stations with good reception automatically. Refer to <Auto Memory Entry> (page 58)
"Receive Mode"	Sets the receive mode of the HD Radio receiver. <b>"Auto"</b> : Automatically tunes to analog broadcast when there is no digital broadcast. <b>"Digital"</b> : Digital broadcasts only. <b>"Analog"</b> : Analog broadcasts only.
"TAG Memory"	Displays the tag memory usage of HD Radio receiver. Up to 50 tags can be registered to this unit. <b>"0"/"50"</b>
"Tagging"	Turns ON / OFF the tag memory function of HD Radio receiver. <b>"OFF"/"ON"</b>

( \_ : Factory setting)

## 5 Make a setting

Press the [◀◀] or [▶▶] button.

## 6 Exit Menu List mode

Press the [MENU] button for at least 1 second, and then press it again briefly.

Function of remote control

## Direct Access Tuning

Tuning in a desired radio station by entering the frequency.

### 1 Select the radio band

### 2 Enter Direct Access Tuning mode

Press the [DIRECT] button.

" \_ \_ \_ \_ " is displayed.

### 3 Select Tuning item

Press the [DIRECT] button.

Pressing the [DIRECT] button each time switches the following tuning items as follows.

Items	Display
Frequency	" _ _ _ _ "
Channel	"HD _ "
Cancelling Direct Access Tuning	—

### 4 Enter the frequency or Channel

Press the number buttons.

Example of frequency input:

Desired frequency	Press button
92.1 MHz (FM)	[9], [2], [1]
810 kHz (AM)	[8], [1], [0]

## 5 Tune in to the entered frequency

Press the [◀◀] or [▶▶] button.

### Cancelling Direct Access Tuning

Press the [DIRECT] button on the remote control.

## iTunes Tagging

Using an iTunes Tagging enabled HD Radio receiver you can tag your music. When you hear a song you enjoy on your local HD Radio station, you only have to press the [SEARCH MODE] button. The song's information will then be saved on this unit. The saved songs will then show up in a playlist called "Tagged" in iTunes the every next time you sync your iPod to your computer. So then you just need to click and then easily buy and download the song you were tagging directly from the Apple iTunes Music Store.

### 1 Enter iTunes tagging mode

Press the [SEARCH MODE] button.

"TAG" will be indicated on the display when song information can be registered.



- Turn "ON" the "TAGGING" of <HD Radio™ Setting> (page 58) when using this function.
- Up to 50 TAGs (song's information) can be registered to this unit. When iPod is connected, the TAG information registered to this unit is transferred to the connected iPod.
- The memory usage can be checked by selecting "TAG MEMORY" of <HD Radio™ Setting> (page 58).

# Basic Operations of remote control

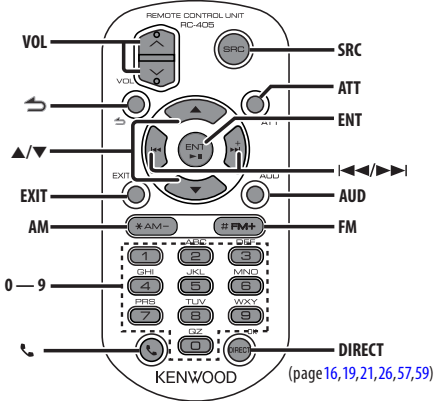

## General control

- Volume control: **[VOL]**
- Source select: **[SRC]**
- Volume reduce: **[ATT]**  
When the button is pressed again, the volume returns to the previous level.
- Return to previous item: **[↶]**
- Exit from mode: **[EXIT]**
- Selection of item: **[▲]/[▼]**
- Determination: **[ENT]**
- Enter Audio Control mode: **[AUD]**

## In Tuner/HD Radio source

- Band select: **[FM]/[AM]**
- Station select: **[◀◀]/[▶▶]**
- Recall preset stations: **[1] — [6]**

## In USB/Music CD/Audio file source

- Music select: **[◀◀]/[▶▶]**
- Folder select: **[FM]/[AM]**
- Pause/Play: **[ENT]**
- Enter Menu List mode: **[▲]/[▼]**
- Movement between folders/files during Search mode: **[▲]/[▼]**
- Return to previous folder: **[↶]**

## In iPod source





- Enter Menu List mode: **[▲]/[▼]**
- Movement between items during Music search mode: **[▲]/[▼]**
- Return to previous item: **[↶]**
- Music select: **[◀◀]/[▶▶]**

## In Satellite Radio tuner source

- Preset band select: **[FM]**
- Channel select: **[◀◀]/[▶▶]**
- Recall preset channels: **[1] — [6]**

## Hands-free phone control

### Making a call

- Enter Bluetooth mode: [
- Select a dialing method: []/[] → [ENT]
- Number dial input:  
Input a digit: [0] – [9]  
Input "+": [▶▶]  
Input "#": [FM]  
Input "\*": [AM]  
Clear the entered phone number: [◀◀]
- Make a call: [DIRECT]

### Receiving a call

- Answer the call: [
- Switch between the private talk mode and the hands-free talk mode: [ENT]

### Call waiting

- Answer Another Incoming Call with the Current Call Suspended: [
- Answer another Incoming Call after Terminating the Current Call: [SRC]
- Continue the Current Call: [1]

### During a call

- End the call: [SRC]

## Preparing the remote control unit

Pull the battery sheet out from the remote control unit to the direction of the arrow.



## Changing the battery of the remote control unit

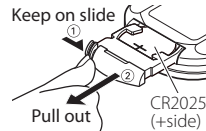

Use a commercially available button battery (CR2025). Insert the battery with the + and – poles aligned properly, following the illustration inside the case.

### ⚠ CAUTION

- Do not set the remote control in hot places such as on the dashboard.
- Lithium battery.  
Danger of explosion if the battery is incorrectly replaced.  
Replace only with the same or equivalent type.
- The battery pack or batteries shall not be exposed to excessive heat such as sunshine, fire or the like.
- Keep battery out of reach of children and in original package until ready to use. Dispose of used batteries promptly. If swallowed contact physician immediately.

# Appendix

## About Audio file

- **Playable Audio file**  
AAC-LC (.m4a), MP3 (.mp3), WMA (.wma)
- **Playable disc media**  
CD-R/RW/ROM
- **Playable disc file format**  
ISO 9660 Level 1/2, Joliet, Romeo, Long file name.
- **Playable USB device**  
USB mass storage class
- **Playable USB device file system**  
FAT16, FAT32

Although the audio files are complied with the standards listed above, the play maybe impossible depending on the types or conditions of media or device.

### Playing order of the Audio file

In the example of folder/file tree shown below, the files are played in the order from ① to ⑩.

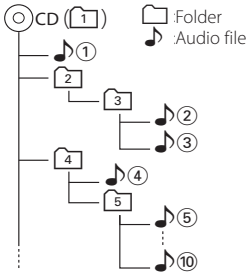

An online manual about audio files is put on the site, [www.kenwood.com/cs/ce/audiofile/](http://www.kenwood.com/cs/ce/audiofile/). On this online manual, detailed information and notes which are not written in this manual are provided. Make sure to read through the online manual as well.



- In this manual, the word "USB device" is used for flash memories and digital audio players which have USB terminals.

## iPod/iPhone that can be connected to this unit

Made for

- iPod nano (1st generation)
- iPod nano (2nd generation)
- iPod nano (3rd generation)
- iPod nano (4th generation)
- iPod nano (5th generation)
- iPod with video
- iPod classic
- iPod touch (1st generation)
- iPod touch (2nd generation)

Works with

- iPhone
- iPhone 3G
- iPhone 3GS



iPod  
4GB 8GB 16GB



iPhone 3G  
8GB 16GB



iPhone 3GS  
16GB 32GB

- Update iPod/iPhone software to the latest version.
- Type of control available varies depending on the type of connected iPod. See [www.kenwood.com/cs/ce/ipod/](http://www.kenwood.com/cs/ce/ipod/) for further details.

- The word "iPod" appearing in this manual indicates the iPod or the iPhone connected with the iPod connection cable\* (optional accessory).

\* Not supported model KCA-iP500.

Refer to the web site for connectable iPod and iPod connection cable.

<http://www.kenwood.com/cs/ce/ipod/>



- If you start playback after connecting the iPod, the music that has been played by the iPod is played first.

In this case, "RESUMING" is displayed without displaying a folder name, etc. Changing the browse item will display a correct title, etc.

- You cannot operate iPod if "KENWOOD" or "✓" displayed on iPod.

## About USB device

- When the USB device is connected to this unit, it can be charged up provided that this unit is powered.
- Install the USB device in the place where it will not prevent you from driving your vehicle properly.
- You cannot connect a USB device via a USB hub and Multi Card Reader.
- Take backups of the audio files used with this unit. The files can be erased depending on the operating conditions of the USB device. We shall have no compensation for any damage arising out of erasure of the stored data.
- No USB device comes with this unit. You need to purchase a commercially available USB device.

- When connecting the USB device, usage of the CA-U1EX (option) is recommended. Normal playback is not guaranteed when a cable other than the USB compatible cable is used. Connecting a cable whose total length is longer than 5 m can result in abnormal playback.

### About “KENWOOD Music Editor”

- This unit supports the PC application “KENWOOD Music Editor Lite ver1.0” or later.
- When you use the audio file with database information added by the “KENWOOD Music Editor Lite ver1.0”, you can search a file by title, album or artist name using the <File Search> (page 14).
- In the Instruction manual, the term “Music Editor media” is used to mean the device that contains audio files with database information added with KENWOOD Music Editor.
- “KENWOOD Music Editor Lite ver1.0” is available from the following web site:  
[www.kenwood.com/cs/ce/](http://www.kenwood.com/cs/ce/)
- For further information on “KENWOOD Music Editor Lite ver1.0”, refer to the site above or the application help.

### About the Cell-Phone

This unit conforms to the following Bluetooth specifications:

#### KDC-X994/KDC-BT945U

<b>Version</b>	Bluetooth Standard Ver. 2.1+EDR
<b>Profile</b>	HFP (Hands Free Profile) OPP (Object Push Profile) PBAP (Phone Book Access Profile) SYNC (Synchronization Profile)

#### KDC-X794/KDC-MP745U

You need to register your cell-phone to your Bluetooth Unit beforehand. Make sure to read the instruction manual of the Bluetooth Unit as well.

For the cell-phones verified for compatibility, access the following URL:

<http://www.kenwood.com/cs/ce/bt/>



- The units supporting the Bluetooth function have been certified for conformity with the Bluetooth Standard following the procedure prescribed by Bluetooth SIG. However, it may be impossible for such units to communicate with your cell-phone depending on its type.
- HFP is a profile used to make a hands-free call.
- OPP is a profile used to transfer data such as a phone book between units.

### About the Bluetooth Audio player

This unit conforms to the following Bluetooth specifications:

#### KDC-X994/KDC-BT945U

<b>Version</b>	Bluetooth Standard Ver. 2.1+EDR
<b>Profile</b>	A2DP (Advanced Audio Distribution Profile) AVRCP (Audio/Video Remote Control Profile)

#### KDC-X794/KDC-MP745U

<b>Version</b>	Bluetooth Standard Ver. 1.2
<b>Profile</b>	A2DP (Advanced Audio Distribution Profile) AVRCP (Audio/Video Remote Control Profile)



- A2DP is a profile designed to transfer the music from an audio player.
- AVRCP is a profile designed to control playback and selection of music by an audio player.

### About Satellite Radio tuner (Optional)

This unit supports Satellite Radio tuners which are released by SIRIUS and XM. Refer to the instruction manual of Satellite radio tuner.

### About HD Radio Reception (Optional)

When you connect an HD Radio tuner, Tuner features of the unit are disabled and changed to HD Radio tuner features. With the HD Radio tuner, you can use the similar functions of Tuner features.

# Appendix

## Menu List

### Common function items

Display	Page
"Settings"	—
"Clock & Date"	34
"Clock Adjust"	
"Time Synchronized"	
"Date Adjust"	
"Date Mode Select"	
"DISP & ILLUMI"	—
"Display Select"	—
"Type Select"	30, 32
"Side Select"	30
"Graphic Select"	32
"Text Select"	30
"Status"	
"Color Select"	32
"Display Off Mode"	28
"Display Dimmer"	
"Contrast"	
"DISP N/P"	
"TEXT Scroll"	
"ILLUMI Dimmer"	
"ILLUMI Effect"	
"ILLUMI MSC SYNC"	
"RDS Settings"	—
"TI"	20
"DEMO Mode"	35

### Function items appearing during standby

Display	Page
"Settings"	—
"Clock & Date"	—
"DISP & ILLUMI"	—
"Initial Settings"	—
"SRC Select"	34
"Beep"	
"MENU Language"	
"Built in AUX"	
"Forced CD-DA"	
"Favorite Delete"	
"Built in AMP"	
"DSI"	

### Function items appearing when the iPod source is selected

Display	Page
"Music"	8
"Playlists"	
"Artists"	
"Albums"	
"Songs"	
"Podcasts"	
"Genres"	
"Composers"	
"Play Mode"	9
"iPod by Hand"	
"Folder Random"	
"All Random"	
"File Repeat"	
"Settings"	—
"Skip Search"	9
>Delete My Playlist"	—
"Clock & Date"	—
"DISP & ILLUMI"	—
"RDS Settings"	—

### Function items appearing when the USB source is selected

Display	Page
"Music"	14
"Play Mode"	15
"File Scan"	
"Folder Random"	
"File Repeat"	
"Folder Repeat"	
"Settings"	—
"Skip Search"	15
"Clock & Date"	—
"DISP & ILLUMI"	—
"RDS Settings"	—

**Function items appearing when the Music CD/  
Audio file source is selected**

Display	Page
"Music"	19
"Play Mode"	18
"File Scan"	
"Track Scan"	
"Folder Random"	
"Disc Random"	
"Magazine Random"	
"File Repeat"	
"Folder Repeat"	
"Track Repeat"	
"Disc Repeat"	
"Settings"	—
"Clock & Date"	—
"DISP & ILLUMI"	—
"RDS Settings"	—

**Function items appearing when the Tuner  
source is selected**

Display	Page
"List & Memory"	21, 21
"FM1"	20
"FM2"	
"FM3"	
"AM"	
"PTY Search"	22
"Settings"	—
"Seek Mode"	20
"Auto Memory"	21
"TI"	20
"Forced MONO"	
"Clock & Date"	—
"DISP & ILLUMI"	—

**Function items appearing when an AUX source  
is selected**

Display	Page
"Settings"	—
"AUX Name Set"	33
"Clock & Date"	—
"DISP & ILLUMI"	—
"RDS Settings"	—

**Function items appearing when the Hands-Free  
source is selected**

Display	Page
"BT Settings"	—
"Phone Selection"	50
"Audio Selection"	
"SMS Download"	54
"SMS inbox"	54
"Voice Tag"	52
"Detailed Setup"	—
"Device Regist."	49
"SPCL DVC Select"	
"Device Delete"	51
"PIN Code Edit"	50
"Auto Answer"	48
"Bluetooth HF/Audio"	
"Call Beep"	
"BT F/W Update"	
"Mic Gain"	
"NR Level"	
"Echo Cancel LV"	
"Clock & Date"	—
"DISP & ILLUMI"	—
"RDS Settings"	—

**Function items appearing when the Bluetooth  
Audio source is selected**

Display	Page
"Settings"	—
"Audio Selection"	50
"Detailed Setup"	—
"Device Regist."	49
"SPCL DVC Select"	
"Device Delete"	51
"PIN Code Edit"	50
"BT F/W Update"	48
"Clock & Date"	—
"DISP & ILLUMI"	—
"RDS Setting"	—

# Appendix







## Function items appearing when the Satellite Radio tuner source is selected

Display	Page
"List & Memory"	57, 57
"SR1"/"XM1"	56
"SR2"/"XM2"	
"SR3"/"XM3"	
"SR4"/"XM4"	
"Channel Search"	56
"Channel Scan"	57
"Settings"	—
"Seek Mode"	56
"ESN"	—
"Clock & Date"	—
"DISP & ILLUMI"	—
"RDS Settings"	—

## Function items appearing when the HD Radio™ tuner source is selected

Display	Page
"List & Memory"	58, 58
"FM1"	58
"FM2"	
"FM3"	
"AM"	
"Settings"	—
"Seek Mode"	58
"Auto Memory"	58
"Receive Mode"	58
"TAG Memory"	—
"Tagging"	—
"Radio ID Watch"	—
"Clock & Date"	—
"DISP & ILLUMI"	—

## Display Indicator items

Source	Display	Overview	
General	"ATT"	Indicates that the attenuator is active.	
	"FAV"	Indicates that the Favorite can be registered.	
iPod/iUSB/ CD/CD Changer	"CD-IN"	Indicates that a disc is inserted.	
	"SCAN"	Indicates that the Scan function is ON.	
	"SCAN"	Indicates that the File Scan function is ON.	
	"RDM"	Indicates that the Disc Random function is ON.	
	"RDM"	Indicates that the Track/File Random function is ON.	
	"Fo-RDM"	Indicates that the Folder Random function is ON.	
	"M-RDM"	Indicates that the Magazine Random function is ON.	
	"ALL-RDM"	Indicates that the All Random function is ON.	
	"PL-RDM"	Indicates that the Playlist Random function is ON.	
	"DMS-RDM"	Indicates that the DMS Random function is ON.	
	"DMS-REP"	Indicates that the DMS Repeat function is ON.	
	"D-REP"	Indicates that the Disc Repeat function is ON.	
	"T-REP"	Indicates that the Track Repeat function is ON.	
Tuner	"Fo-REP"	Indicates that the Folder Repeat function is ON.	
	"Fi-REP"	Indicates that the File Repeat function is ON.	
	"P-REP"	Indicates that the Playlist Repeat function is ON.	
	"REP"	Indicates that the Repeat function is ON.	
	"MP3"	Identifies the MP3 file.	
	"WMA"	Identifies the WMA file.	
	"AAC"	Identifies the AAC-LC file.	
	"MYLIST"	Indicates that the My Playlist mode is selected now.	
	"RDS"	Indicates the RDS is being received.	
	"ST"	Indicates that stereo broadcast is being received.	
	"TI"	Indicates the reception state of traffic information. (On: TI is being received. Blinking: TI is not being received.)	
	HD Radio	"HD A"	Indicates that analog broadcast is being received.
		"HD D"	Indicates that digital broadcast is being received.
"M/S"		Indicates whether the reception channel is main or sub. (On: The channel is main. Blinking: The channel is sub.)	
"MC"		Indicates that Multi channel is being received.	
"ST"		Indicates that stereo broadcast is being received.	
"TAG"		Indicates that Tagging is enabled.	
Hands- Free	"C-Wait"	Indicates call-waiting.	
	"PRIVATE"	Indicates a cell-phone call in progress.	
	"BT"	Indicates that the Bluetooth function can be used.	
		Indicates that battery level of cell-phone. Full  Nearly dead	
		Indicates that the battery level of cell-phone cannot be obtained.	
		Indicates that signal strength of cell-phone. Maximum  Minimum	
	OUT	Indicates the out of coverage zone.	
		Indicates that the signal strength of cell-phone cannot be obtained.	



# Appendix

## ▲ CAUTION

Use of controls or adjustments or performance of procedures other than those specified herein may result in hazardous radiation exposure. In compliance with Federal Regulations, following are reproductions of labels on, or inside the product relating to laser product safety.

Kenwood Corporation  
2967-3, ISHIKAWA-MACHI,  
HACHIOJI-SHI  
TOKYO, JAPAN

KENWOOD CORP. CERTIFIES THIS EQUIPMENT  
CONFORMS TO DHHS REGULATIONS NO.21 CFR  
1040. 10, CHAPTER 1, SUBCHAPTER J.

Location : Top Panel

## FCC WARNING

This equipment may generate or use radio frequency energy. Changes or modifications to this equipment may cause harmful interference unless the modifications are expressly approved in the instruction manual. The user could lose the authority to operate this equipment if an unauthorized change or modification is made.

## FCC NOTE

This equipment has been tested and found to comply with the limits for a Class B digital device, pursuant to Part 15 of the FCC Rules. These limits are designed to provide reasonable protection against harmful interference in a residential installation. This equipment may cause harmful interference to radio communications, if it is not installed and used in accordance with the instructions. However, there is no guarantee that interference will not occur in a particular installation. If this equipment does cause harmful interference to radio or television reception, which can be determined by turning the equipment off and on, the user is encouraged to try to correct the interference by one or more of the following measures:

- Reorient or relocate the receiving antenna.
- Increase the separation between the equipment and receiver.
- Connect the equipment into an outlet on a circuit different from that to which the receiver is connected.
- Consult the dealer or an experienced radio/TV technician for help.

- Contains Transmitter Module  
FCC ID : RKXCK5050NEW
- Contains Transmitter Module  
IC ID : 5119A-CK5050NEW

## IC (Industry Canada) Notice

Operation is subject to the following two conditions:  
(1) This device may not cause interference, and  
(2) this device must accept any interference, including interference that may cause undesired operation of the device.

The term "IC:" before the certification/registration number only signifies that the Industry Canada technical specification were met.

This product contains a CR Coin Cell Lithium Battery which contains Perchlorate Material – special handling may apply.

See [www.dtsc.ca.gov/hazardouswaste/perchlorate](http://www.dtsc.ca.gov/hazardouswaste/perchlorate)

- HD Radio™ Technology Manufactured Under License From iBiquity Digital Corp. U.S. and Foreign Patents. HD Radio™ and the HD Radio Ready logos are proprietary trademarks of iBiquity Digital Corp.
- The "AAC" logo is trademark of Dolby Laboratories.
- The Bluetooth word mark and logos are owned by the Bluetooth SIG, Inc. and any use of such marks by Kenwood Corporation is under license. Other trademarks and trade names are those of their respective owners.
- iTunes is a trademark of Apple Inc.
- iPod is a trademark of Apple Inc., registered in the U.S. and other countries.
- iPhone is a trademark of Apple Inc.
- "Made for iPod" means that an electronic accessory has been designed to connect specifically to iPod and has been certified by the developer to meet Apple performance standards.
- "Works with iPhone" means that an electronic accessory has been designed to connect specifically to iPhone and has been certified by the developer to meet Apple performance standards.
- Apple is not responsible for the operation of this device or its compliance with safety and regulatory standards.

# Accessories/ Installation Procedure

## Accessories

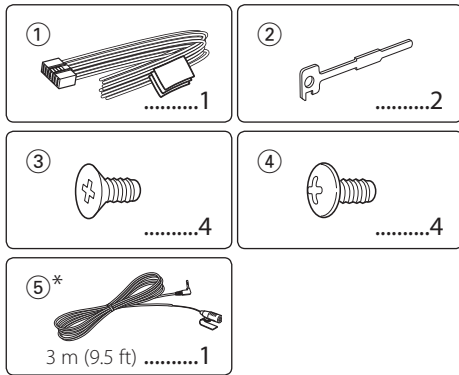

\*Accessory of KDC-X994/ KDC-BT945U

## Installation Procedure

- 1 To prevent a short circuit, remove the key from the ignition and disconnect the  $\ominus$  battery.
- 2 Make the proper input and output wire connections for each unit.
- 3 Connect the speaker wires of the wiring harness.
- 4 Connect the wiring harness wires in the following order: ground, battery, ignition.
- 5 Connect the wiring harness connector to the unit.
- 6 Install the unit in your car.
- 7 Reconnect the  $\ominus$  battery.
- 8 Press the reset button.

### ⚠ WARNING

If you connect the ignition wire (red) and the battery wire (yellow) to the car chassis (ground), you may cause a short circuit, that in turn may start a fire. Always connect those wires to the power source running through the fuse box.



- Mounting and wiring this product requires skills and experience. For safety's sake, leave the mounting and wiring work to professionals.
- Make sure to ground the unit to a negative 12V DC power supply.
- Do not install the unit in a spot exposed to direct sunlight or excessive heat or humidity. Also avoid places with too much dust or the possibility of water splashing.
- Do not use your own screws. Use only the screws provided. If you use the wrong screws, you could damage the unit.
- If the power is not turned ON ("PROTECT" is displayed), the speaker wire may have a short-circuit or touched the chassis of the vehicle and the protection function may have been activated. Therefore, the speaker wire should be

checked.

- If your car's ignition does not have an ACC position, connect the ignition wires to a power source that can be turned on and off with the ignition key. If you connect the ignition wire to a power source with a constant voltage supply, as with battery wires, the battery may die.
- If the console has a lid, make sure to install the unit so that the faceplate will not hit the lid when closing and opening.
- If the fuse blows, first make sure the wires aren't touching to cause a short circuit, then replace the old fuse with one with the same rating.
- Insulate unconnected wires with vinyl tape or other similar material. To prevent a short circuit, do not remove the caps on the ends of the unconnected wires or the terminals.
- Connect the speaker wires correctly to the terminals to which they correspond. The unit may be damaged or fail to work if you share the  $\ominus$  wires or ground them to any metal part in the car.
- When only two speakers are being connected to the system, connect the connectors either to both the front output terminals or to both the rear output terminals (do not mix front and rear). For example, if you connect the  $\oplus$  connector of the left speaker to a front output terminal, do not connect the  $\ominus$  connector to a rear output terminal.
- After the unit is installed, check whether the brake lamps, blinkers, wipers, etc. on the car are working properly.
- Mount the unit so that the mounting angle is 30° or less.
- Reception may drop if there are metal objects near the Bluetooth antenna.



Bluetooth antenna unit

### About CD players/disc changers connected to this unit

If the CD player/ disc changer has the "O-N" switch, set it to the "N" position.

The functions you can use and the information that can be displayed may differ depending on the models being connected.

### For Good Reception

To assure good reception, note the following:

- Communicate with the cell-phone within the line-of-sight distance of 10 m (30 ft). The communication range becomes shorter depending on the surrounding environment. The communication range also becomes shorter when there is an obstacle between this unit and the cell-phone. The above maximum communication range (10 m) is not always assured.
- A broadcast station or walkie-talkie located nearby can interfere with communication due to too strong signal.

# Connecting Wires to Terminals

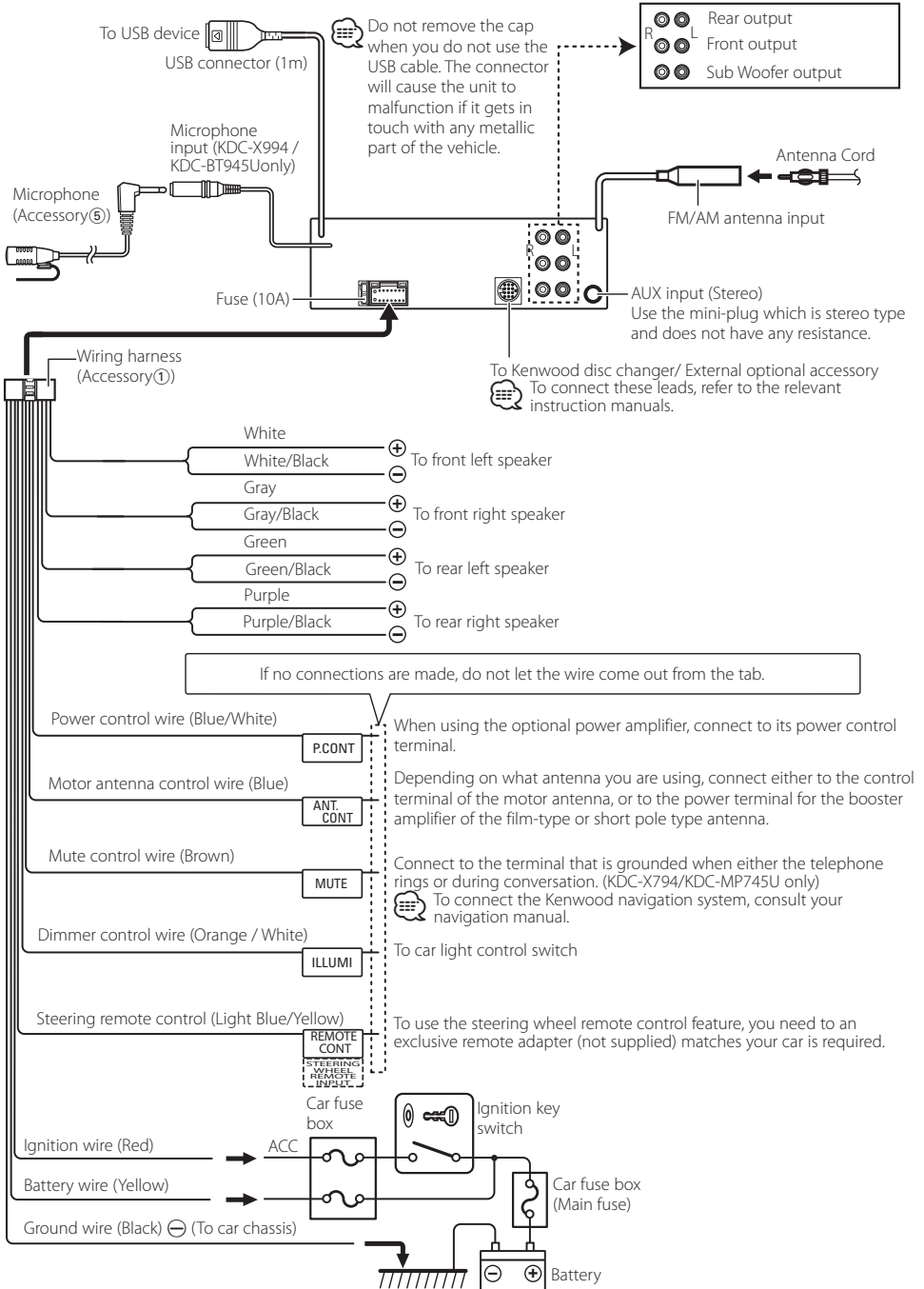

# Installation/Removing the Unit

## non-Japanese cars

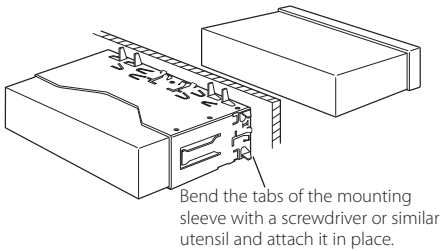

- Make sure that the unit is installed securely in place. If the unit is unstable, it may malfunction (for example, the sound may skip).

## Japanese cars

- 1 Refer to the section <Removing the hard rubber frame> and then remove the hard rubber frame.
- 2 Align the holes in the unit (two locations on each side) with the vehicle mounting bracket and secure the unit with the accessory screws.

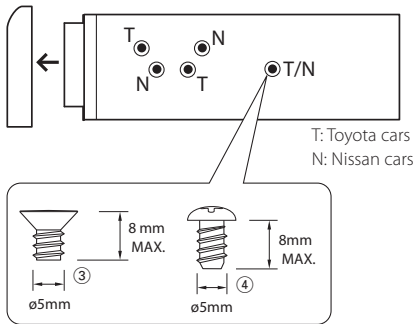

### CAUTION

Install this unit in the console of your vehicle. Do not touch the metal part of this unit during and shortly after the use of the unit. Metal part such as the heat sink and enclosure become hot.

## Removing the hard rubber frame

- 1 Engage the catch pins on the removal tool and remove the two locks on the upper level. Upper the frame and pull it forward as shown in the figure.

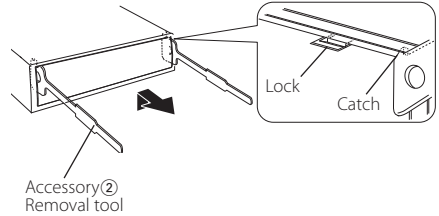

- 2 When the upper level is removed, remove the lower two locations.



- The frame can be removed from the bottom side in the same manner.

## Removing the Unit

- 1 Refer to the section <Removing the hard rubber frame> and then remove the hard rubber frame.
- 2 Detach the faceplate.
- 3 Insert the two removal tools deeply into the slots on each side, as shown.
- 4 Lower the removal tool toward the bottom, and pull out the unit halfway while pressing towards the inside.

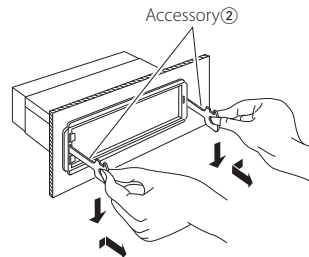

- Be careful to avoid injury from the catch pins on the removal tool.
- 5 Pull the unit all the way out with your hands, being careful not to drop it.

# Installation/Removing the Unit

Accessory of KDC-X994/ KDC-BT945U

## Installation the Microphone Unit

- 1 Check the installation position of the microphone (accessory ⑤).
- 2 Remove oil and other dirt from the installation surface.
- 3 Install the microphone.
- 4 Wire the cable up to the unit with it secured at several positions using tape or the like.

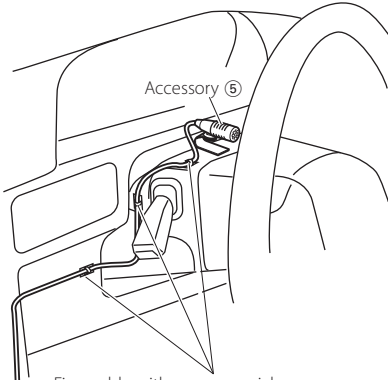

Fix a cable with a commercial item of tape.

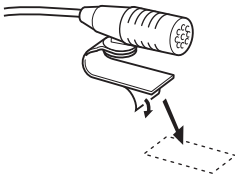

Peel the release coated paper of double-face adhesive tape to fix on the place shown above.





Adjust the direction of the microphone to the driver.







- Install the microphone as far as possible from the cell-phone.

# Troubleshooting Guide

Some functions of this unit may be disabled by some settings made on this unit.

- ! Cannot set up the subwoofer.**
- No output from the subwoofer.**
- Cannot set up the subwoofer position of Manual position setting.**
  - ▶ The Dual zone function is enabled.  <Dual Zone System> (page 40)
  - ▶ In the speaker select option, None is selected for the subwoofer.  <Speaker Setting> (page 42)

- ! Cannot set up the equalizer.**
- Cannot set up the Bass Boost.**
- Cannot set up the Highway sound.**
- Cannot set up the Supreme.**
- Cannot set up the Position control.**
  - ▶ The Dual zone function is enabled.  <Dual Zone System> (page 40)
  - ▶ The DSP function is disabled.  "DSP Set" of <Audio Control> (page 38)
  - ▶ In the speaker select option, None is selected for the rear speakers.  <Speaker Setting> (page 42)

- ! Cannot select the output destination of the subsource in the Dual zone.**
- Cannot adjust the volume of the rear speakers.**
  - ▶ The Dual zone function is disabled.  <Dual Zone System> (page 40)

- ! Cannot set up Display.**
  - ▶ <Demonstration mode Setting> (page 35) is not turned off.

- ! Cannot switch to USB/iPod source.**
  - ▶ The Dual zone function is set to USB/iPod.  <Dual Zone System> (page 40)

- ! The number of songs contained in "SONGS" category of this unit is different from that contained in "SONGS" category of iPod.**
  - ▶ Podcast files are not counted in this unit as this unit does not support the playback of podcast files.

What might seem to be a malfunction in your unit may just be the result of slight misoperation or miswiring. Before calling service, first check the following table for possible problems.

## General

- ? The operation check sound (beep sound) does not sound.**

- ✓ The preout jack is being used.
  -  The Touch Sensor Tone cannot be output from the preout jack.

- ? The illumination flashes when the knob or button is operated.**

- ✓ This is the key illumination effect.
  -  You set this effect in "ILLUMI Effect" of <Display Setting> (page 28).

- ? The key illumination effect brought about in conjunction with the sound volume is small.**

- ✓ The key illumination effect may be insufficient depending on the sound volume and sound quality.



## Tuner source

- ? Radio reception is poor.**

- ✓ The car antenna is not extended.
  -  Pull the antenna out all the way.



## Disc source

- ? The specified disc does not play, but another one plays instead.**

- ✓ The specified CD is quite dirty.
  -  Clean the CD, referring to the CD cleaning of the section on <Handling CDs> (page 5).
- ✓ The disc is loaded in a different slot from that specified.
  -  Eject the disc magazine and check the number for the specified disc.
- ✓ The disc is severely scratched.
  -  Try another disc instead.

## Audio file source

- ? The sound skips when an Audio file is being played.**

- ✓ The media is scratched or dirty.
  -  Clean the media, referring to the CD cleaning of the section on <Handling CDs> (page 5).
- ✓ The recording condition is bad.
  -  Record the media again or use another media.

# Troubleshooting Guide

## Hands-free

### ? The hands-free talk volume is low.

- ✓ The hands-free talk volume is set at a low level.
  - ☞ The hands-free talk volume can be adjusted independently. Adjust it during hands-free talk. "Mic Gain" and "NR Level" <Bluetooth Setting> (page 48).

### ? No sound is heard from the rear speakers.

- ✓ You are talking in the hand-free talk mode.
  - ☞ No sound is heard from the rear speakers in the hands-free talk mode.

### ? No beep is heard at reception of an incoming call.

- ✓ No beep is heard depending on the type of your cell-phone.
  - ☞ The "Call Beep" of <Bluetooth Setting> (page 48) is set ON.

### ? Voice is not recognized.

- ✓ The vehicle window is open.
  - ☞ If the surrounding noise is large, voice cannot be recognized properly. Close the vehicle windows to reduce noise.
- ✓ Small voice.
  - ☞ If voice is too small, it cannot be recognized properly. Speak into the microphone a little more loudly and naturally.
- ✓ The person uttering the voice tag is not the one who registered the it.
  - ☞ Only the voice of the person who registered the voice tag can be recognized.

## Bluetooth audio source

### ? The Bluetooth audio player cannot be registered (pairing).

- ✓ The PIN code is fixed.
  - ☞ When a PIN code is specified in the Instruction Manual for Bluetooth Audio Player, register it with reference to <Registering PIN Code> (page 50) to register the Bluetooth audio player. If no PIN code is specified in the Instruction Manual, try "0000".

### ? The sound from the Bluetooth audio player is discontinuous.

- ✓ The distance between this unit and audio player is too far.
  - ☞ Move the audio player nearer to this unit.
- ✓ Another Bluetooth device is affecting the Bluetooth communication.
  - ☞ Turn off another Bluetooth device.
  - ☞ Move another Bluetooth device away from this unit.
- ✓ Another Bluetooth device or profile is used for communication.
  - ☞ The downloading of the Phone book or the SMS disconnects the sound.

## The messages shown below display your systems condition.

- TOC Error:
  - No disc has been loaded in the disc magazine.
  - The CD is quite dirty. The CD is upside-down. The CD is scratched a lot.
- ERROR 05: The disc is unreadable.
- ERROR 77/Mecha Error:
  - The unit is malfunctioning for some reason.
  - ☞ Press the reset button on the unit. If the "ERROR 77"/"Mecha Error" code does not disappear, consult your nearest service center.
- ERROR 99: Something is wrong with the disc magazine. Or the unit is malfunctioning for some reason.
  - ☞ Check the disc magazine. And then press the reset button on the unit. If the "ERROR 99" code does not disappear, consult your nearest service center.
- CD-IN (Blink): The CD player section is not operating properly.
  - ☞ Reinsert the CD. If the CD cannot be ejected or the display continues to flash even when the CD has been properly reinserted, please switch off the power and consult your nearest service center.
- Protect (Blink):
  - The speaker wire has a short-circuit or touches the chassis of the vehicle, and then the protection function is activated.
  - ☞ Wire or insulate the speaker cable properly and press the reset button. If the "Protect" code does not disappear, consult your nearest service center.
- Unsupported File:
  - An Audio file is played with a format that this unit can't support.
- Copy Protection:
  - A copy-protected file is played.
- Read Error: The file system of the connected USB device is broken.
  - ☞ Copy the files and folders for the USB device again. If the error message is still displayed, initialize the USB device or use other USB devices.
- No Device: The USB device is selected as a source although no USB device is connected.
  - ☞ Change the source to any source other than USB. Connect an USB device, and change the source to USB again.

N/A Device:	<ul style="list-style-type: none"> <li>• An unsupported USB device is connected.</li> <li>• Connection to the iPod has failed.</li> <li>➤ Check that the connected iPod is an iPod that is supported. See &lt;About Audio file&gt; (page 62) for information on supported iPods.</li> </ul>	Err No Matching:	The voice tag is wrong. Voice cannot be recognized because of an unregistered voice tag, etc.
No Music Data/Error 15:	<ul style="list-style-type: none"> <li>• The connected USB device contains no playable audio file.</li> <li>• Media was played that does not have data recorded that the unit can play.</li> </ul>	Too Soft:	Voice is too small and cannot be recognized.
USB ERROR:	<p>Some trouble may have occurred to the connected USB device.</p> <ul style="list-style-type: none"> <li>➤ Remove the USB device, then cycle the power switch to ON. If the same display is repeated, use another USB device.</li> </ul>	Too Loud:	Voice is too large to be recognized.
iPod Error:	<p>Connection to the iPod has failed.</p> <ul style="list-style-type: none"> <li>➤ Remove the USB device and then reconnect it.</li> <li>➤ Confirm that the software for the iPod is the latest version.</li> </ul>	Too Long:	The word or utterance is too long to be recognized.
USB REMOVE (Blink):	The Remove mode has been selected for the USB device/iPod. You can remove the USB device/iPod safely.	No Phonebook:	Data is not contained in the phone book.
No Number:	<ul style="list-style-type: none"> <li>• The calling party does not notify a caller ID.</li> <li>• There is no phone number data.</li> </ul>	No Message:	No short message in In Box.
No Data:	<ul style="list-style-type: none"> <li>• There is no outgoing call list.</li> <li>• There is no incoming call list.</li> <li>• There is no missed call list.</li> <li>• There is no phone book list.</li> </ul>	No Record:	The voice tag is not registered in the phone book.
No Entry:	The cell-phone has not been registered (pairing).	Memory Full:	The number of voice tags reaches the maximum number to be registered in the phone book.
HF Disconnect:	The unit cannot communicate with the cell-phone.	Favorite: No Memory:	The procedure is not registered to Favorite Preset Memory
HF Error 07:	<p>The memory cannot be accessed.</p> <ul style="list-style-type: none"> <li>➤ Turn off the power and on again. If this message still appears, press the reset button on the control unit.</li> </ul>	No Access:	The procedure preset with Favorite Control cannot be available. The preset content may not be recalled depending on the selected source or mode.
HF Error 68:	<p>The unit cannot communicate with the cell-phone.</p> <ul style="list-style-type: none"> <li>➤ Turn off the power and on again. If this message still appears, press the reset button on the control unit.</li> </ul>	No Voice:	No call.
Un Known:	The Bluetooth device cannot be detected.		
Device Full:	5 Bluetooth device have already been registered. No more Bluetooth device cannot be registered.		
PIN Code NG:	The PIN code is wrong.		
Connect NG:	The unit cannot be connected to the device.		
Pairing Failed:	Pairing error.		

# Specifications

## FM tuner section

---

- Frequency range (200 kHz space)
  - : 87.9 MHz – 107.9 MHz
- Usable sensitivity (S/N = 30dB)
  - : 9.3dBf (0.8  $\mu$ V/75  $\Omega$ )
- Quieting Sensitivity (S/N = 50dB)
  - : 15.2dBf (1.6  $\mu$ V/75  $\Omega$ )
- Frequency response ( $\pm$ 3 dB)
  - : 30 Hz – 15 kHz
- Signal to Noise ratio (MONO)
  - : 70 dB
- Selectivity ( $\pm$ 400 kHz)
  - :  $\geq$  80 dB
- Stereo separation (1 kHz)
  - : 40 dB

## AM tuner section

---

- Frequency range (10 kHz space)
  - : 530 kHz – 1700 kHz
- Usable sensitivity (S/N = 20dB)
  - : 28 dB $\mu$  (25  $\mu$ V)

## Bluetooth section (KDC-X994/ KDC-BT945U)

---

- Version
  - : Bluetooth Ver.2.1+EDR Certified
- Frequency range
  - : 2.402 – 2.480 GHz
- Output Power
  - : +4dBm (MAX), 0dBm (AVE) Power Class 2
- Maximum Communication range
  - : Line of sight approx.10m (32.8 ft)
- Profiles
  - : HFP (Hands Free Profile)
  - : HSP (Headset Profile)
  - : SPP (Serial Port Profile)
  - : PBAP (Phone Book Access Profile)
  - : OPP (Object Push Profile)
  - : SYNC (Synchronization Profile)
  - : A2DP (Advanced Audio Distribution Profile)
  - : AVRCP (Audio/Video Remote Control Profile)

## USB Interface

---

- USB Standard
  - : USB1.1/ 2.0 (Full speed)
- Maximum Supply current
  - : 500 mA
- File System
  - : FAT16/ 32
- MP3 decode
  - : Compliant with MPEG-1/2 Audio Layer-3
- WMA decode
  - : Compliant with Windows Media Audio
- AAC decode
  - : AAC-LC ".m4a" files

## CD player section

---

- Laser diode
  - : GaAlAs
- Digital filter (D/A)
  - : 8 Times Over Sampling
- D/A Converter
  - : 24 Bit
- Spindle speed
  - : 500 – 200 rpm (CLV)
- Wow & Flutter
  - : Below Measurable Limit
- Frequency response ( $\pm$ 1 dB)
  - : 10 Hz – 20 kHz
- Total harmonic distortion (1 kHz)
  - : 0.008 %
- Signal to Noise ratio (1 kHz)
  - KDC-X994/KDC-X794: 110 dB
  - KDC-BT945U/KDC-MP745U: 105 dB
- Dynamic range
  - : 93 dB
- MP3 decode
  - : Compliant with MPEG-1/2 Audio Layer-3
- WMA decode
  - : Compliant with Windows Media Audio
- AAC decode
  - : AAC-LC ".m4a" files

## Audio section

---

Maximum output power  
: 50 W x 4

Full Bandwidth Power (at less than 1% THD)  
: 22 W x 4

Speaker Impedance  
: 4 – 8  $\Omega$

Tone action (KDC-X994/KDC-X794)  
BAND1 (60 Hz):  $\pm 9$  dB  
BAND2 (250 Hz):  $\pm 9$  dB  
BAND3 (1 kHz):  $\pm 9$  dB  
BAND4 (4 kHz):  $\pm 9$  dB  
BAND5 (16 kHz):  $\pm 9$  dB

Tone action (KDC-BT945U/KDC-MP745U)  
BAND1 : 60 Hz - 400 Hz  $\pm 9$  dB  
BAND2 : 630 Hz - 2.5 kHz  $\pm 9$  dB  
BAND3 : 4.0 kHz - 16 kHz  $\pm 9$  dB

Preout level / Load (CD)  
KDC-X994/KDC-X794/KDC-BT945U  
: 4000 mV/10 k $\Omega$   
KDC-MP745U: 2500 mV/10 k $\Omega$

Preout impedance  
:  $\leq 600 \Omega$

## Auxiliary input

---

Frequency response ( $\pm 1$  dB)  
: 20 Hz – 20 kHz

Input Maximum Voltage  
: 1200 mV

Input Impedance  
: 10 k $\Omega$

## General

---

Operating voltage  
KDC-X994/KDC-BT945U (10.5 – 16V allowable)  
: 14.4 V  
KDC-X794/KDC-MP745U (11 – 16V allowable)  
: 14.4 V

Maximum Current consumption  
: 10 A

Installation Size (W x H x D)  
: 182 x 53 x 158 mm  
7-3/16 x 2-1/16 x 6-1/4 inch

Weight  
: 2.9 lbs (1.30 kg)

• Specifications subject to change without notice.



This symbol mark indicates that Kenwood manufactured this product so as to decrease harmful influence on the environment.

---

**KENWOOD**