

SHE68P06UC

24" Evolution 800 Series

Dishwasher



Features and Benefits

Appearance

- Stainless Steel TallTub
- 6 Wash Cycles and 3 Options

Quietness

- Virtually Silent: 44 dBA
- Two Pumps Minimize Noise & Vibration
- Solid Base Contains Sound & Prevents Leaks

Efficiency

- 234 kwh/yr - Energy Star®
- EcoSense™ Reduces Energy Usage by up to 20%
- Half Load Option for Small Loads
- Flow-Through Water Heater™
- Quadruple Filtration System

Safety

- AquaStop® Leak Protection
- Sanitize Option eliminates bacteria and enhances drying results
- NSF Certified - Eliminates 99.9% of Bacteria
- Concealed Heating Element - No Melting of Plastics
- SaniDry™ Hygienic Condensation Drying

Capacity

- 14 Place Setting Capacity
- 800 Series Racks with Flexible Silverware Basket
- RackMatic® Automatically Adjustable Upper Rack
- Extra Tall Item Sprinkler Cleans Items 22" Tall



Notes: All height, width and depth dimensions are shown in inches. *Please refer to installation instructions prior to making cutout. BSH reserves the absolute and unrestricted right to change product materials and specifications, at any time, without notice. Consult the product's installation instructions for final dimensional data and other details. Applicable product warranty can be found in a accompanying product literature or you may contact your account manager for further details.

For more information on our entire line of products, go to boschappliances.com or call 1-800-944-2904.
Copyright ©2009 BSH Home Appliances Corporation. All rights reserved. Bosch is a registered trademark of Robert Bosch GmbH.

Litho Date: 10/2009



SHE68P06UC

24" Evolution 800 Series

Dishwasher

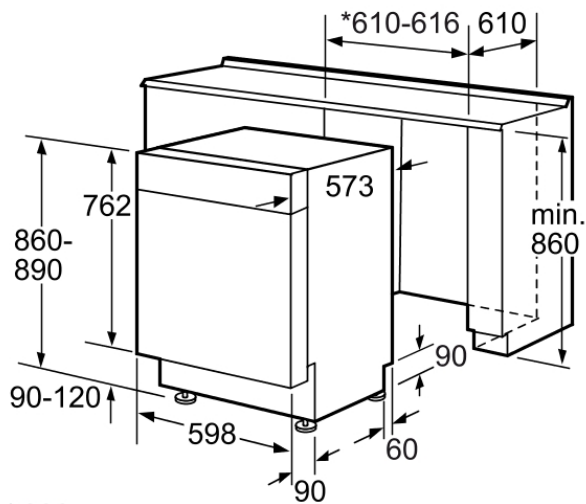

* 600
without decor strips Measurements in mm

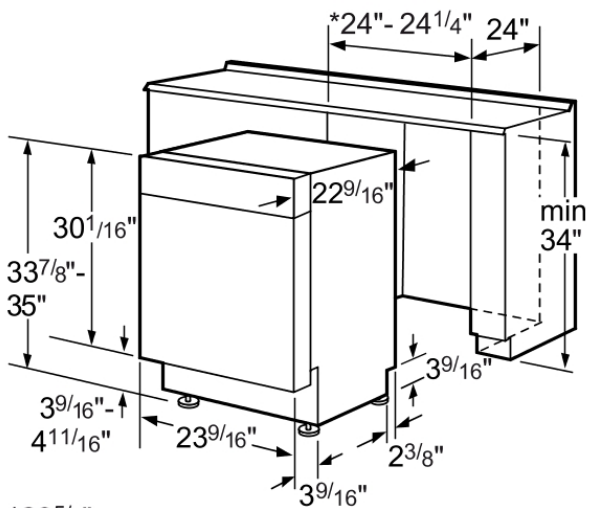

*23 5/8"
without decor strips in inch

Features

UPC code	825225878605
Main color of product	Black
Installation Type	Build-under
Panel ready	Not possible
Alternative colors available	SHE68P02UC, SHE68P05UC
Silence level (dBA)	44
Watts (W)	1400
Current (A)	12
Volts (V)	120
Frequency (Hz)	60
Total annual energy consumption (kWh)	234
Energy Star® qualified	Yes
Plug type	Fixed connection
Power cord length (in)	
Length outlet hose (in)	150 "
Length inlet hose (in)	
Required cutout size (HxWxD) (in)	33 15/16" - 35" x 24 " x 24 "
Overall appliance dimensions (HxWxD) (in)	33 7/8 " x 23 9/16 " x 22 9/16 "
Product packaging dimensions (HxWxD) (in)	36.22 x 26.37 x 25.98
Net weight (lbs)	100
Gross weight (lbs)	111
Adjustable feet	Yes
Tube material	Stainless steel
Tube type	TALLTUB
ADA Compliant	No
Number of place settings	14

Technical Specification

Leak Protection System	AQUASTOP
ChildLock	Childlock appliance
Water softener	No
Top basket type	800
Adjustable upper rack	Rackmatic
Shelf Racks in Top Basket	2
Upper rack cup shelf	
Bottom basket type	800
Bottom basket Inserts	0
3rd Rack	no
Silverware basket	Standard
Optional accessories	SGZ1010UC, SGZ1052UC,

Notes: All height, width and depth dimensions are shown in inches. *Please refer to installation instructions prior to making cutout. BSH reserves the absolute and unrestricted right to change product materials and specifications, at any time, without notice. Consult the product's installation instructions for final dimensional data and other details. Applicable product warranty can be found in a accompanying product literature or you may contact your account manager for further details.

For more information on our entire line of products, go to boschappliances.com or call 1-800-944-2904.
Copyright ©2009 BSH Home Appliances Corporation. All rights reserved. Bosch is a registered trademark of Robert Bosch GmbH.

Litho Date: 10/2009

