

# Table of Contents

<b>1. Introduction</b> .....	<b>5</b>
1.1. Minimum System Requirements .....	6
1.1.1. Windows users .....	6
1.1.2. Mac Users .....	6
1.1.3. Linux Users .....	6
1.2. Box Content .....	7
<b>2. Getting Connected</b> .....	<b>8</b>
2.1. Connect the USB Interface Cable .....	9
2.2. Connect the FireWire Interface Cable .....	10
2.3. Connect the Optional Power Sharing Cable .....	11
2.4. Launching LaCie Setup Assistant.....	12
2.5. Disconnecting Your LaCie Hard Drive.....	13
<b>3. Optional Formatting and Partitioning</b> .....	<b>14</b>
3.1. Formatting for Windows Users.....	15
3.1.1. Formatting from FAT32 to NTFS .....	15
3.1.2. Formatting from HFS+ (Apple File System) to NTFS.....	17
3.2. Formatting for Mac Users .....	19
<b>4. Interface and Data Transfer Information</b> .....	<b>20</b>
4.1. Cables and Connectors.....	20
4.1.1. USB 2.0 Cables and Connectors .....	20
4.1.2. FireWire Cables and Connectors .....	20
4.2. Data Transfers .....	21
<b>5. Troubleshooting</b> .....	<b>22</b>
5.1. Mac Troubleshooting .....	22
5.2. Windows Troubleshooting.....	23
<b>6. Contacting Customer Support</b> .....	<b>25</b>
6.1. LaCie Technical Support Contacts .....	26
<b>7. Warranty Information</b> .....	<b>27</b>

## Copyrights

Copyright © 2009 LaCie. All rights reserved. No part of this publication may be reproduced, stored in a retrieval system, or transmitted in any form or by any means, electronic, mechanical, photocopying, recording or otherwise, without the prior written consent of LaCie.

## Trademarks

Apple, Mac, and Macintosh are registered trademarks of Apple Computer, Inc. Microsoft, Windows 2000, Windows XP and Windows Vista are registered trademarks of Microsoft Corporation. Other trademarks mentioned in this manual are the property of their respective owners.

## Changes

The material in this document is for information only and subject to change without notice. While reasonable efforts have been made in the preparation of this document to assure its accuracy, LaCie assumes no liability resulting from errors or omissions in this document, or from the use of the information contained herein. LaCie reserves the right to make changes or revisions in the product design or the product manual without reservation and without obligation to notify any person of such revisions and changes. Canada Compliance Statement This Class A digital apparatus meets all requirements of the Canadian Interference-Causing Equipment Regulations.

## FCC Statement



This device complies with Part 15 of the FCC Rules. Operation is subject to the following conditions:

1. The devices may not cause harmful interference
2. The devices must accept any interference received, including interference that may cause undesired operation.

NOTE: This equipment has been tested and found to comply with the limits for a Class B digital device, pursuant to Part 15 of the FCC Rules. These limits are designed to provide reasonable protection against harmful interference in a residential installation. This equipment generates, uses and can radiate radio frequency energy and, if not installed and used in accordance with the instructions, may cause harmful interference to radio communications. However, there is no guarantee that interference will not occur in a particular installation. If this equipment does cause harmful interference to radio or television reception, which can be determined by turning the equipment off and on, the user is encouraged to try and correct the interference by one or more of the following measures:

- ◆ Reorient or relocate the receiving antenna.
- ◆ Increase the separation between the equipment and receiver.
- ◆ Connect the equipment into an outlet on a circuit different from that to which the receiver is connected.
- ◆ Consult the dealer or an experienced radio/TV technician for help.

Modifications to this product not authorized by LaCie could void the FCC & Industry Canada regulations and negate your authority to operate the product.



We, LaCie, solemnly declare that this product conforms to the following European standards: Class B EN60950, EN55022, EN55024

With reference to the following conditions: 73/23/EEC Low Voltage Directive; 89/336/EEC EMC Directive



This symbol on the product or on its packaging indicates that this product must not be disposed of with your other household waste.

Instead, it is your responsibility to dispose of your waste equipment by handing it over to a designed collection point for the recycling of waste electrical and electronic equipment. The separate collection and recycling of your waste equipment at the time of disposal will help to conserve natural resources and ensure that it is recycled in a manner that protects human health and the environment. For more information about where you can drop off your waste equipment for recycling, please contact your local city office, your household waste disposal service, or the shop where you purchased the product.

---

**CAUTION:** This LaCie hard drive's warranty may be void as a result of the failure to respect the precautions listed above.

---

## Health and Safety Precautions

- ◆ Only qualified persons are authorized to carry out maintenance on this device.
- ◆ Read this user manual carefully and follow the correct procedure when setting up the device.
- ◆ Do not open your LaCie Mobile Hard Drive or attempt to disassemble or modify it. Never insert any metallic object into the drive to avoid any risk of electrical shock, fire, short-circuiting or dangerous emissions. Your LaCie Mobile Hard Drive contains no user-serviceable parts. If it appears to be malfunctioning, have it inspected by a qualified LaCie Technical Support representative.
- ◆ Never expose your device to rain, or use it near water, or in damp or wet conditions. Never place objects containing liquids on the LaCie Mobile Hard Drive, as they may spill into its openings. Doing so increases the risk of electrical shock, short-circuiting, fire or personal injury.
- ◆ Make sure that the computer and LaCie Mobile Hard Drive are electrically grounded. If the devices are not grounded, there is an increased risk of electrical shock. Power requirements 100-240 V~, 1.5 A, 60- 50 Hz, (Supply voltage fluctuations not exceeding  $\pm 10\%$  of the nominal, transient over-voltages according to over-voltage category II).

## General Use Precautions

- ◆ Do not expose the LaCie Mobile Hard Drive to temperatures outside the range of 5° C to 35° C (41° F to 95° F); or to operational humidity beyond 5-80%, non-condensing, or non-operating humidity beyond 10-90%, non-condensing. Doing so may damage the LaCie Mobile Hard Drive or disfigure its casing. Avoid placing your LaCie Mobile Hard Drive near a source of heat or exposing it to sunlight (even through a window). Inversely, placing your LaCie Mobile Hard Drive in an environment that is too cold or humid may damage the unit.
- ◆ Always unplug the LaCie Mobile Hard Drive from the electrical outlet if there is a risk of lightning or if it will be unused for an extended period of time. Other-

wise, there is an increased risk of electrical shock, short-circuiting or fire.

- ◆ Use only the power supply shipped with the device.
- ◆ Do not use the LaCie Mobile Hard Drive near other electrical appliances such as televisions or radios. Doing so may cause interference which will adversely affect the operation of the other products.
- ◆ Do not place the LaCie Mobile Hard Drive near sources of magnetic interference, such as computer displays, televisions or speakers. Magnetic interference can affect the operation and stability of your LaCie Mobile Hard Drive.
- ◆ Do not place heavy objects on top of the LaCie Mobile Hard Drive or use excessive force on it.
- ◆ Never use excessive force on your LaCie Mobile Hard Drive. If you detect a problem, see the Troubleshooting section in this manual.

---

---

**CAUTION:** This LaCie Little Disk's warranty may be void as a result of the failure to respect the precautions listed above.

---

---

**IMPORTANT INFO:** Any loss, corruption or destruction of data while using a LaCie drive is the sole responsibility of the user, and under no circumstances will LaCie be held liable for the recovery or restoration of this data. To help prevent the loss of your data, LaCie highly recommends that you keep **TWO** copies of your data; one copy on your external hard disk, for instance, and a second copy either on your internal hard disk, another external hard disk or some other form of removable storage media. LaCie offers a complete line of CD and DVD drives. If you would like more information on backup, please refer to our website.

---

---

**IMPORTANT INFO:** 1GB = 1,000,000,000 bytes. 1TB = 1,000,000,000,000 bytes. Once formatted, the actual available storage capacity varies depending on operating environment (typically 5-10% less).

---

---

## Using this Manual

Some sections of this user manual contain information that applies to some LaCie Little Disk models, but not all of them. Look for Manual Notes like the one to below to determine if the section applies to your LaCie Little Disk.

This symbol ✓ appears next to models to which the section DOES apply.

This symbol ✗ appears next to models to which the section does NOT apply.

Manual Notes are not used in sections which apply to all Little Disk models.

---

### MANUAL NOTE:

- ✓ Little Disk Pocket Hard Drive USB 2.0
  - ✓ Little Disk Portable Hard Drive USB 2.0
  - ✗ Little Disk Portable Hard Drive (USB/FireWire)
- 

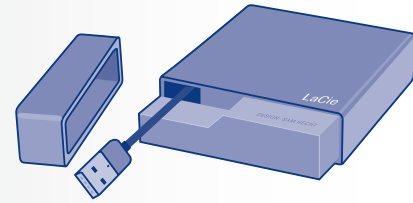

Little Disk Pocket Hard Drive USB 2.0

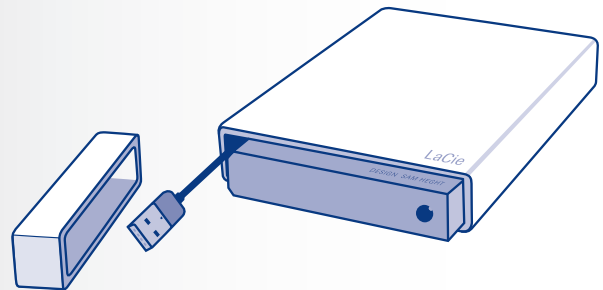

Little Disk Portable Hard Drive USB 2.0

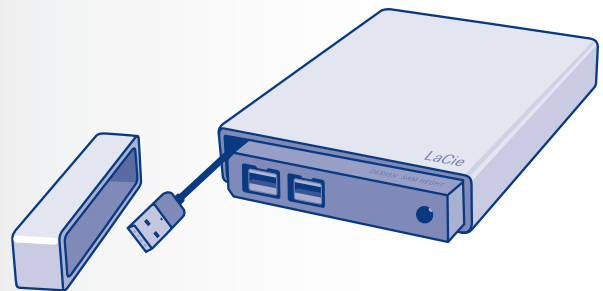

Little Disk Portable Hard Drive USB/FireWire

# 1. Introduction

Building on over a decade of design excellence, LaCie has created a new line of drives that are timeless and crafted to blend functionality with high-technology. These latest drives are performance-based solutions that will power you through your specific applications.

Ideal for speed intensive applications, the LaCie Hard Drive handles the curves of your demanding data needs. Secure and stable, the LaCie Hard Drive is an ideal way to add space to your computer; you can divide the drive into specific spaces (partitions) for different parts of your data, or leave it alone and simply use it as one big volume.

## Quick Links

### Click a topic:

- ◆ Getting Connected
- ◆ Optional Formatting and Partitioning
- ◆ Troubleshooting



---

## 1.1. Minimum System Requirements

### 1.1.1. Windows users

- ◆ Windows 2000, Windows XP or Windows Vista
- ◆ 233MHz Pentium or higher
- ◆ 32MB RAM or greater
- ◆ USB 2.0\*, FireWire 400, or FireWire 800\*\* interface port
- ◆ Internet connection (for downloading updates)

---

### 1.1.2. Mac Users

- ◆ Mac OS 10.3 or later
- ◆ G3 or later or Intel Core processor
- ◆ 32MB RAM or greater
- ◆ USB 2.0\*, FireWire 400, or FireWire 800\*\* interface port
- ◆ Internet connection (for downloading updates)

---

### 1.1.3. Linux Users

- ◆ Linux 2.4 / 2.6
- ◆ 32MB RAM or greater
- ◆ USB 2.0\*, FireWire 400, or FireWire 800\*\* interface port
- ◆ Internet connection (for downloading updates)

---

• To achieve USB 2.0 speeds, your drive must be connected to a USB 2.0 host port. If it is connected to a USB 2.0 port, your drive will operate at USB 2.0 speeds.

\*\* Most computers do not come from the factory with FireWire 800 ports, so you may need to purchase a PCI, PCI-X or PCI-Express card to be able to connect your hard via FireWire 800 interface. LaCie offers a wide selection of PCI cards. Visit the LaCie website at [www.lacie.com/accessories](http://www.lacie.com/accessories).

---

## 1.2. Box Content

1. LaCie Little Disk Pocket Hard Drive USB 2.0  
or  
LaCie Little Disk Portable Hard Drive USB 2.0  
or  
LaCie Little Disk Portable Hard Drive USB/FireWire
2. Power sharing cable (Little Disk Portable Hard Drive USB/  
FireWire only)\*
3. FireWire 800 (9-to-9 pin) cable \*\*
4. FireWire 400 to 800 (6-to-9 pin) cable \*\*
5. Quick Install Guide

---

**IMPORTANT INFO:** Please save your packaging. In the event that the drive should need to be repaired or serviced, it must be returned in its original packaging.

---

\* The USB power sharing cable is included only with the LaCie Little Disk Portable Hard Drive USB/FireWire. If you wish to use the cable with the Little Disk Portable Hard Drive USB 2.0, it can be purchased from the LaCie website.

\*\* FireWire cables not included with Little Disk Pocket Hard Drive or Little Disk Portable Hard Drive USB 2.0.

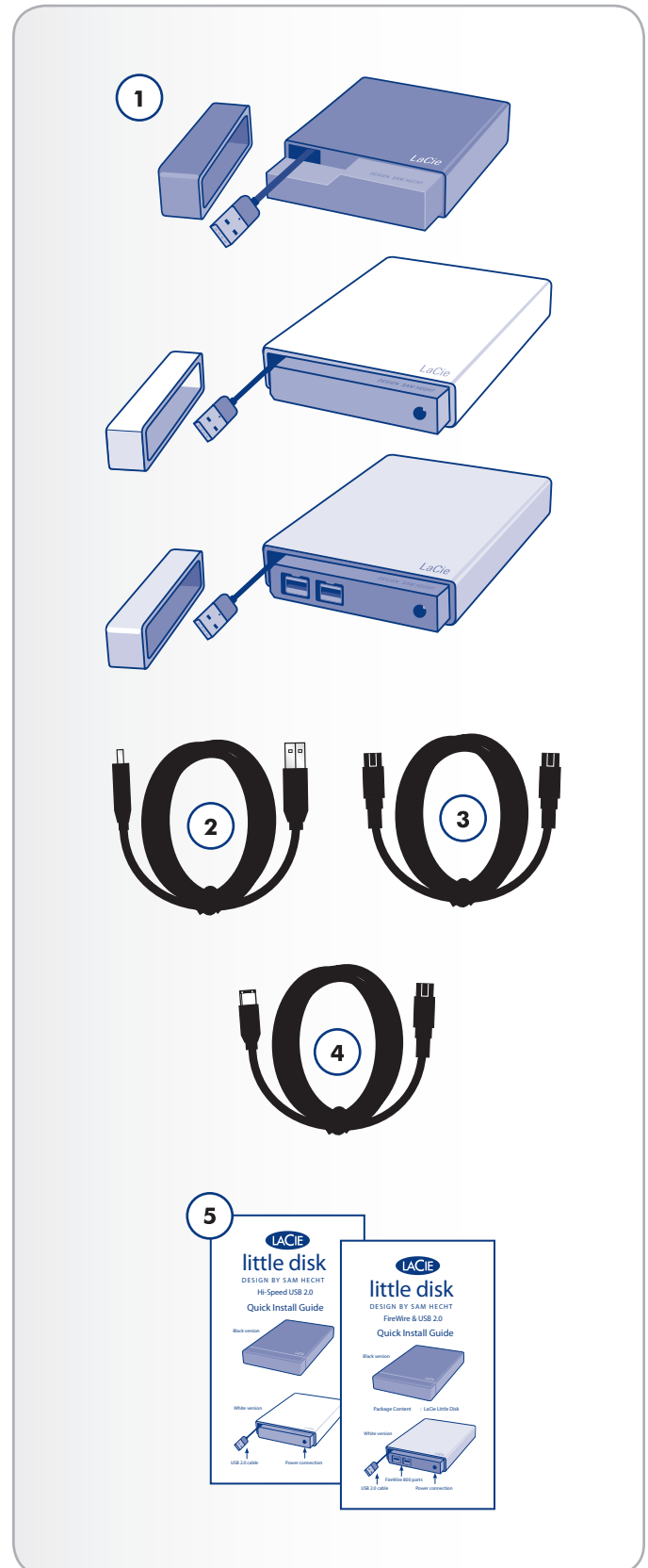

## 2. Getting Connected

Follow these steps to quickly get your LaCie hard drive powered on and connected to your computer.

Step 1	<p><a href="#">2.1. Connect the USB Interface Cable</a></p> <ul style="list-style-type: none"><li>✓ Little Disk Pocket Hard Drive USB 2.0</li><li>✓ Little Disk Portable Hard Drive USB 2.0</li><li>✓ Little Disk Portable Hard Drive USB/FireWire</li></ul> <p><a href="#">2.2. Connect the FireWire Interface Cable</a></p> <ul style="list-style-type: none"><li>✗ Little Disk Pocket Hard Drive USB 2.0</li><li>✗ Little Disk Portable Hard Drive USB 2.0</li><li>✓ Little Disk Portable Hard Drive USB/FireWire</li></ul>
Step 2	<p><a href="#">2.3. Connect the Optional Power Sharing Cable</a></p> <ul style="list-style-type: none"><li>✗ Little Disk Pocket Hard Drive USB 2.0</li><li>✓ Little Disk Portable Hard Drive USB 2.0*</li><li>✓ Little Disk Portable Hard Drive USB/FireWire</li></ul>
Step 3	<p><a href="#">2.4. Launching LaCie Setup Assistant</a></p>
Step 4	<p><a href="#">3. Optional Formatting and Partitioning</a></p>

- 
- Note that the Little Disk Portable Hard Drive USB 2.0 does not include the power sharing cable, but it can be purchased from the LaCie website.

## 2.1. Connect the USB Interface Cable

### MANUAL NOTE:

- ✓ Little Disk Pocket Hard Drive USB 2.0
- ✓ Little Disk Portable Hard Drive USB 2.0
- ✓ Little Disk Portable Hard Drive USB/FireWire)

1. Remove the cap.
2. Pull out the integrated USB 2.0 cable until it stops (*Fig. 01*). The cord is about 2 inches long; do not attempt to pull it out farther.
3. Insert the USB 2.0 connector into an available USB 2.0 port on your computer (*Fig. 02*).
4. After a few seconds, the hard drive will mount on your computer and appear on the desktop (Mac users) or in My Computer (Windows users).
5. Proceed to section [2.4. Launching LaCie Setup Assistant](#).

**IMPORTANT INFO:** If your Little Disk Portable Hard Drive does not power on within a few seconds of connecting the USB interface cable, proceed to section [2.3. Connect the Optional Power Sharing Cable](#).

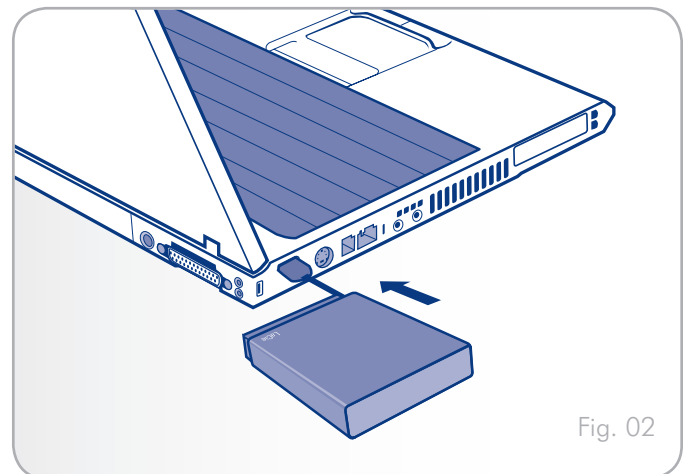
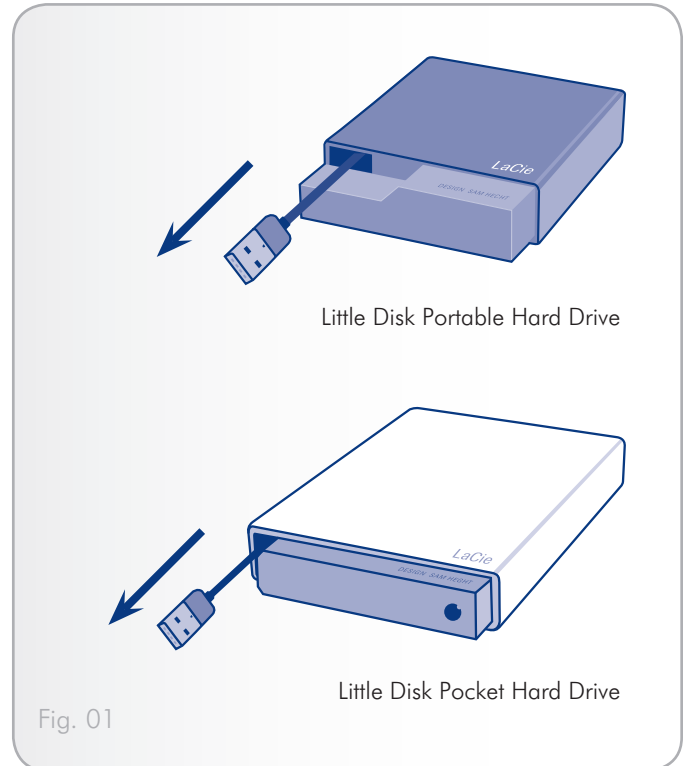

## 2.2. Connect the FireWire Interface Cable

---

---

### MANUAL NOTE:

- ✗ Little Disk Pocket Hard Drive USB 2.0
  - ✗ Little Disk Portable Hard Drive USB 2.0
  - ✓ Little Disk Portable Hard Drive USB/FireWire)
- 
- 

1. Remove the cap.

### Either:

2. Attach the rectangular end of the FireWire 400 to 800 (6-to-9 pin) cable to the hard drive and the other end to a FireWire 400 port on your computer;

### Or:

2. Attach one end of the FireWire 800 (9-to-9 pin) cable to the hard drive and the other end to a FireWire 800 port on your computer ([Fig. 03](#)).

### Then:

3. After a few seconds, the hard drive will mount on your computer and appear on the desktop (Mac users) or in My Computer (Windows users).
4. Proceed to section [2.4. Launching LaCie Setup Assistant](#).

---

---

**TECHNICAL NOTE:** For help with understanding the different types of FireWire cables included with your drive, refer to section [4.1. Cables and Connectors](#).

---

---

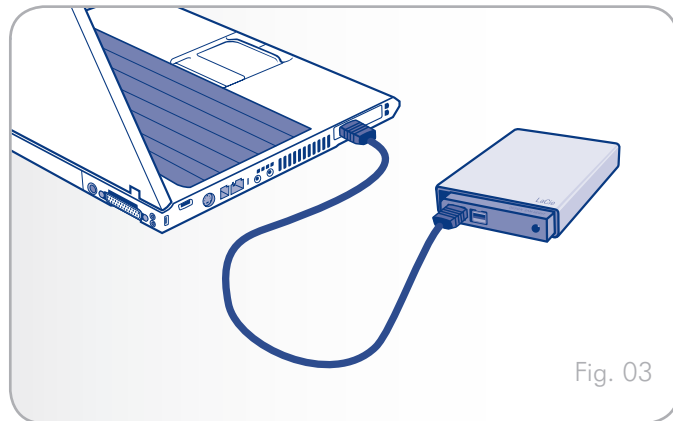

Fig. 03

## 2.3. Connect the Optional Power Sharing Cable

---

**MANUAL NOTE:**

- ✗ Little Disk Pocket Hard Drive USB 2.0
  - ✓ Little Disk Portable Hard Drive USB 2.0\*
  - ✓ Little Disk Portable Hard Drive USB/FireWire)
- 

In the event that the USB bus on your computer does not provide enough power to operate your drive, you may use the included USB power sharing cable to supply additional power to the drive from your computer.

1. Attach the small end of the power sharing cable to the back of your LaCie drive (*Fig. 04*).
2. Attach the USB end of the USB power sharing cable to an available USB port on your computer.

---

**IMPORTANT INFO:** If the USB power sharing cable does not work with your specific computer configuration, LaCie offers an optional power supply, sold separately. Please contact your LaCie reseller or LaCie Customer Service for more information.

---

\* Note that the Little Disk Portable Hard Drive USB 2.0 does not include the power sharing cable, but it can be purchased from the LaCie website.

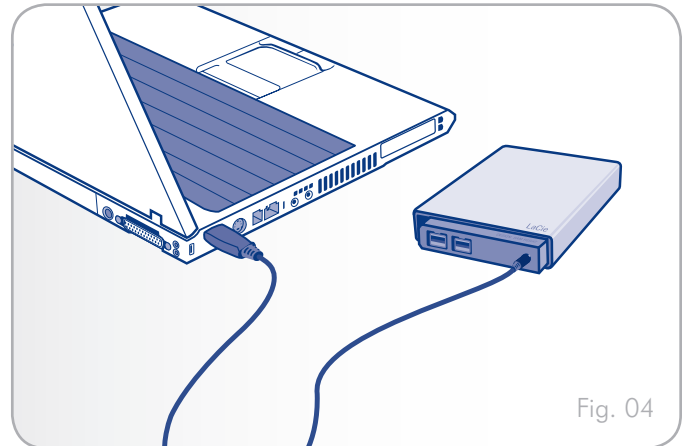

Fig. 04

## 2.4. Launching LaCie Setup Assistant

Before using your drive, LaCie Setup Assistant software must be launched to format your drive. It will:

- ◆ Optimize your drive according to your needs
- ◆ Copy the manual and utilities onto your LaCie hard disk

---

**IMPORTANT INFO:** LaCie recommends that you copy the user manual and utilities onto your computer's internal hard drive or other medium when setup is complete.

---

### To launch LaCie Setup Assistant:

**Windows** users: double click on the LaCie drive icon in "My Computer".

**Mac** users: double click on the "LaCie Setup Assistant" icon which will appear on your desktop.

---

**IMPORTANT INFO:** If you do not launch LaCie Setup Assistant or if you quit LaCie Setup Assistant after formatting has begun, your drive will not be ready to use and will require manual formatting. The user manual and utilities will not be available on your drive and will have to be downloaded from the LaCie website: [www.lacie.com](http://www.lacie.com)

---

---

**TECHNICAL NOTE:** The LaCie Setup Assistant does not prevent you from using your computer's native disk utility program to format or partition your LaCie drive. Simply follow the Setup Assistant through completion, then use your computer's native disk utility (Disk Management for Windows or Disk Utility for Mac) to reformat your drive. See section 3. *Optional Formatting and Partitioning* for more information.

---

---

## 2.5. Disconnecting Your LaCie Hard Drive

USB external devices feature “plug & play” connectivity, which means that your drive can be connected and disconnected while the computer is running. To prevent failures, however, it is important to follow these steps when disconnecting your LaCie hard drive.



### Windows Users

1. From the **System Tray** (located in the lower right-hand side of your screen), click the **Eject** icon (a small green arrow over a hardware image).
2. A message will appear, listing the devices the Eject icon controls (it should say, “Safely remove...”). Click on the LaCie Little Disk in this prompt.
3. This message will appear: “Safe to Remove Hardware” (or similar). It is now safe to disconnect the device.



### Mac Users

1. Drag the hard disk icon to the trash.
2. When the icon disappears from the desktop, the drive can be disconnected.

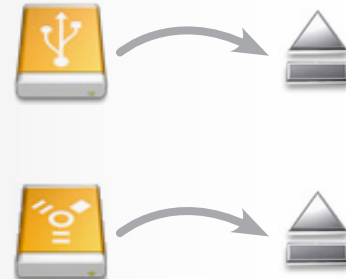

## 3. Optional Formatting and Partitioning

The first time you use your LaCie Little Disk, LaCie Setup Assistant formats your drive according to your needs. If your needs change, you can reformat your LaCie Little Disk to optimize it for use with Windows or Mac, or for cross-platform use. For example, if you used LaCie Setup Assistant to format your drive to work with your Mac (HFS+), but now you want to share your hard disk with Windows users, you can reformat it to FAT 32 (MS-DOS) for this purpose.

You may need to format your LaCie Little Disk if LaCie Setup Assistant was interrupted or stopped. If the hard disk does not appear in My Computer (Windows) or on the desktop (Mac), it may not be formatted properly.

### What is Formatting?

When a disk is formatted, the following things occur: the operating system erases all of the bookkeeping information on the disk, tests the disk to make sure that all of the sectors are reliable, marks bad sectors (i.e., those that are scratched) and creates internal address tables that it later uses to locate information. Your LaCie Hard Drive is preformatted in FAT-32 (MSDOS) format. To reformat your drive, follow the instructions in this section.

### What is Partitioning?

You can also divide the hard disk into sections, called partitions. A partition is a section of the hard disk's storage capacity that is created to contain files and data. For instance, you could create three partitions on your drive: one partition for your office documents, one as a backup and one for your multimedia files. Or, if you will be sharing the drive with another person in your household or office, you can create a partition for each person who uses the drive. Partitioning is optional.

---

**TECHNICAL INFORMATION:** The LaCie hard drive is preformatted in FAT-32 (MS-DOS) format, optimized for use with Mac and Windows OS. See File System Formats, below for explanations of the other possible file formats.

---

---

**IMPORTANT INFO:** Reformatting will erase everything from the hard drive. If you have information that you want to protect or continue to use, back up this information before reformatting.

---

### File System Formats

There are three different file system format categories: NTFS, FAT 32 (MS-DOS), and Mac OS Extended (HFS+). Use the information below to determine which format is best for you.

#### Use NTFS if...

...you will be using the drive only with Windows 2000, Windows XP or Windows Vista (performance will generally be greater when compared to FAT 32). This file system is compatible in read only mode with Mac OS X 10.3 and higher.

#### Use HFS+ if...

...you will be using the drive on Macs only; performance will generally be greater when compared to FAT 32. This file system is NOT compatible with Windows OS.

#### Use FAT 32 (MS-DOS) if...

...you will be using your drive with both Windows and Mac OS X 10.3 or sharing the drive between Windows 2000 and Windows XP or Windows Vista. Maximum single file size is 4GB.

### 3.1. Formatting for Windows Users

- ◆ If your disk is formatted as a FAT32 volume, proceed to section 3.1.1. *Formatting from FAT32 to NTFS*.
- ◆ If your disk is formatted as an HFS+ volume (or unrecognized in Windows) , click here or proceed to section 3.1.2. *Formatting from HFS+ (Apple File System) to NTFS*.

#### 3.1.1. Formatting from FAT32 to NTFS

Follow these steps if you used LaCie Setup Assistant to create an exchange volume on your LaCie Little Disk for data sharing between Windows and Mac computers or if you reformatted your LaCie Little Disk as a FAT32 volume on a Mac.

**CAUTION:** Following these steps will erase everything from the hard disk. If you have information that you want to protect or continue to use, back up this information before performing these steps.

1. Right-click **My Computer** and select **Manage** (Fig. 05). The Computer Management window opens.
2. Select **Disk Management** under Storage (you may have to expand the Storage list to see the Disk Management option). See Fig. 06. Information about all storage devices connected to your computer appears in the pane on the right.
3. Find the disk corresponding to your LaCie Little Disk. Right-click in the disk allocation bar of the FAT32 volume and select **Format...** from the right-click options menu (Fig. 06).

**TECHNICAL NOTE:** If you did not create an exchange volume using LaCie Setup Assistant, there may be only one volume associated with the disk.

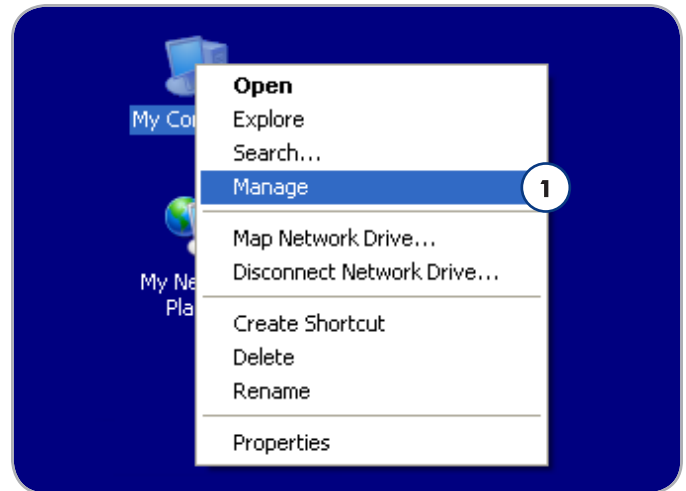

Fig. 05

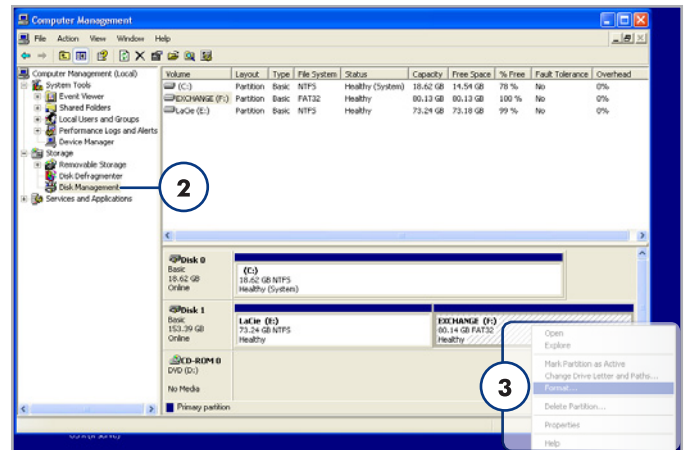

Fig. 06

Continued on next page...

4. In the Format window:
  - a. Enter a name for the disk as you'd like it to appear on your computer in the Volume label field.
  - b. Select "Perform a quick format".
  - c. Leave the other options at their default values and click OK.
5. Click **OK** in the format warning dialog. During the formatting process, the status of the disk changes to "Formatting" in the Computer Management window. When Formatting is complete, the status changes to "Healthy". See [Fig. 08](#).

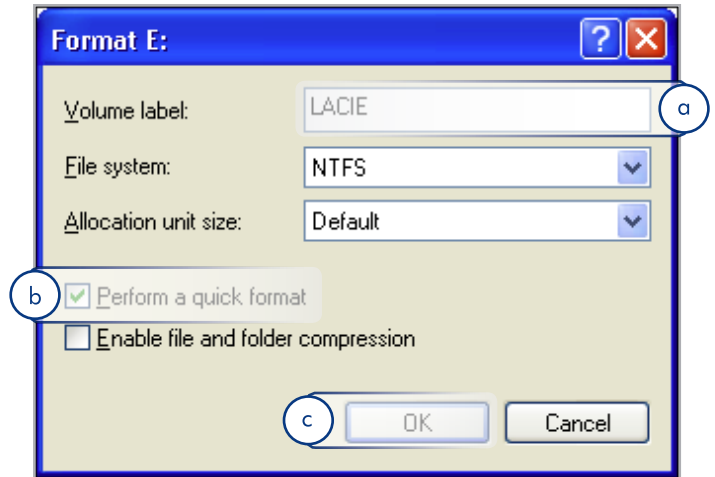

Fig. 07

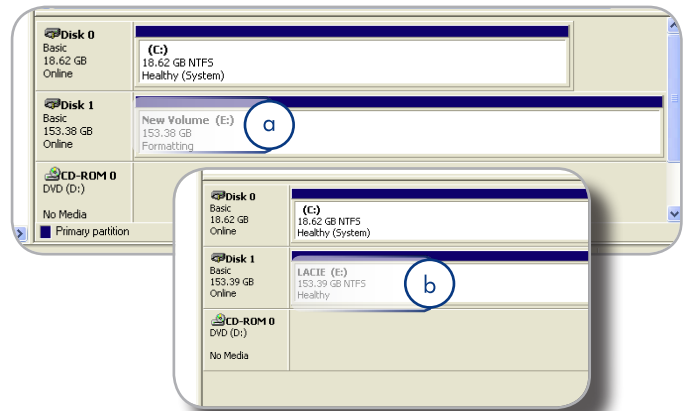

Fig. 08

### 3.1.2. Formatting from HFS+ (Apple File System) to NTFS

Follow the steps in this section if you used LaCie Setup Assistant to format your drive for use with a Mac or if you reformatted your LaCie Little Disk as an HFS+ volume on a Mac.

**CAUTION:** Following these steps will erase everything from the hard disk. If you have information that you want to protect or continue to use, back up this information before performing these steps.

1. Right-click **My Computer** and select **Manage** (Fig. 09). The Computer Management window opens.
2. Select **Disk Management** under Storage (you may have to expand the Storage list to see the Disk Management option). See Fig. 10. Information about all storage devices connected to your computer appears in the pane on the right.
3. Find the disk corresponding to your LaCie Little Disk. Right-click on the "Unallocated" volume in the disk allocation bar and select **New Partition...** from the right-click options menu (Fig. 10). The New Partition Wizard opens.

Continued on next page...

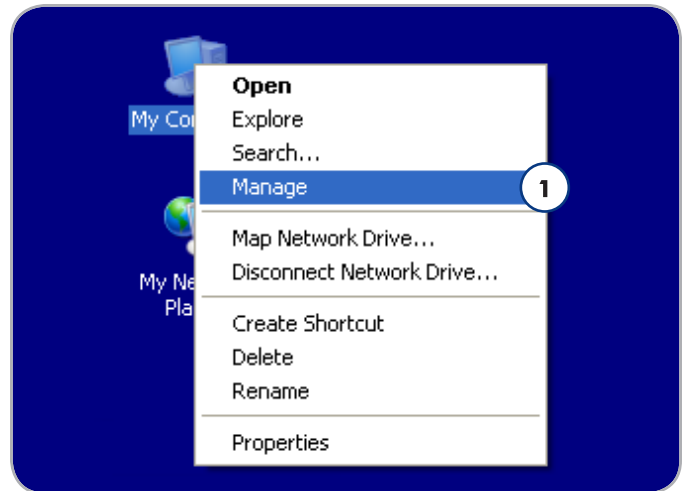

Fig. 09

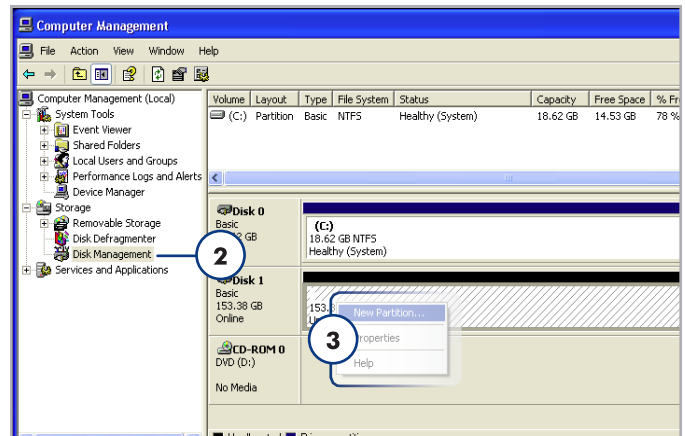

Fig. 10

- On the Welcome to the New Partition Wizard screen, click **Next**.
- Select **Primary Partition** and click **Next**.
- If you would like to create more than one partition on the disk, enter the size of the first partition in the "Partition size in MB" field. Otherwise, leave the default values and click **Next**.
- Choose a drive letter to assign to the drive. Click **Next**.
- Select "Format this partition with the following settings" and Enter a name for the volume as you'd like it to appear on your computer. Select "Perform a quick format." Click **Next**. See [Fig. 12](#).
- Review your settings and click **Finish** to begin the formatting process.
- During the formatting process, the status of the disk changes to "Formatting" (a) in the Computer Management window. When Formatting is complete, the status changes to "Healthy" (b). See [Fig. 13](#).

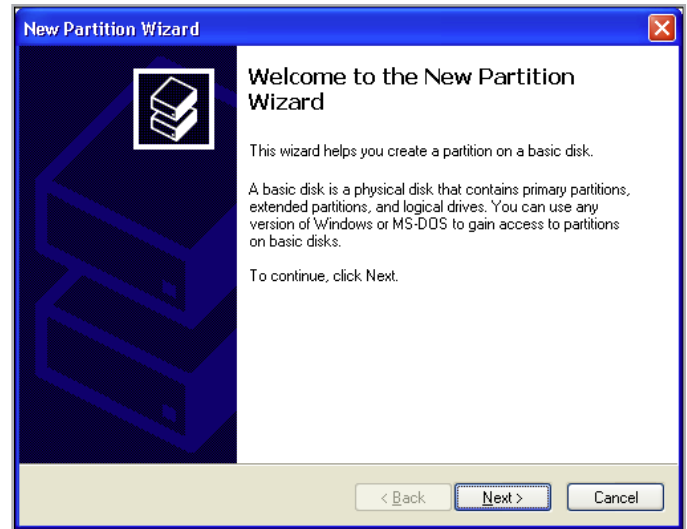

Fig. 11

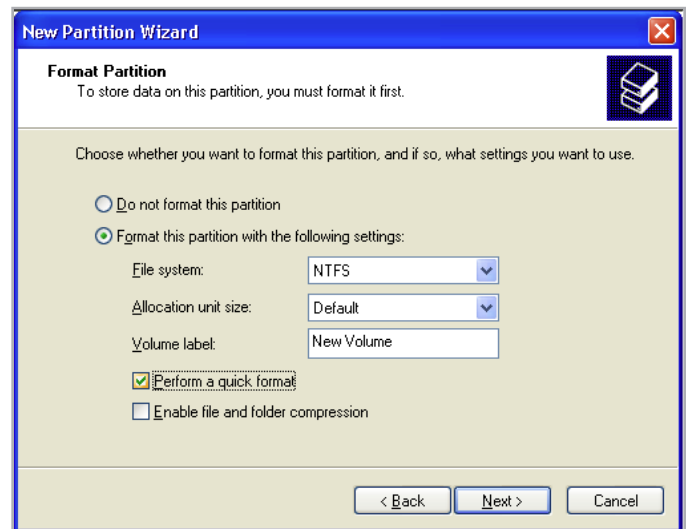

Fig. 12

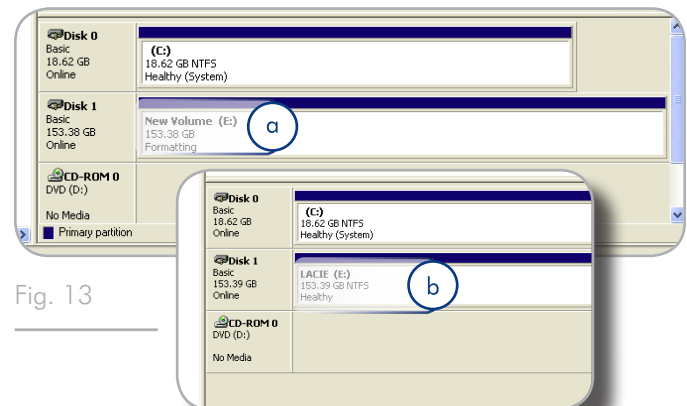

Fig. 13

## 3.2. Formatting for Mac Users

**CAUTION:** Following these steps will erase everything from the hard disk. If you have information that you want to protect or continue to use, back up this information before performing these steps.

1. Select **Utilities** from the Go menu in Finder.
2. Open Disk Utility.
3. In the disk list on the left side of the Disk Utility window, find the disk corresponding to your LaCie Little Disk. For each disk there is a listing for the drive controller and one for each volume on the disk. Select the listing for the controller (ex. "153.4 GB HDT72251 6D..." in [Fig. 14](#)).
4. Select the **Partition** tab.
5. From the **Volume Scheme** menu, choose the number of partitions you want to divide the drive into (16 maximum). You can adjust the size of each partition using the slide bar between the partitions in the **Volume Scheme** area.
6. In the **Volume Information** section, enter a name for each volume (partition) and choose the volume format (Mac OS Extended, Mac OS Standard, UNIX File System, or MS-DOS).

**TECHNICAL NOTE:** To share a volume with Windows users, select MS-DOS (FAT32) format.

**IMPORTANT INFO:** Apple recommends that unless you have a specific reason to use the UNIX File System (UFS), you should use the Mac OS Extended format because it provides a more familiar experience to Macintosh users.

7. Click **Partition**. Click **Partition** again to close the alert message and continue.
8. Mac Disk Utility will format and partition the disk according to your settings, and your drive will be ready to use.

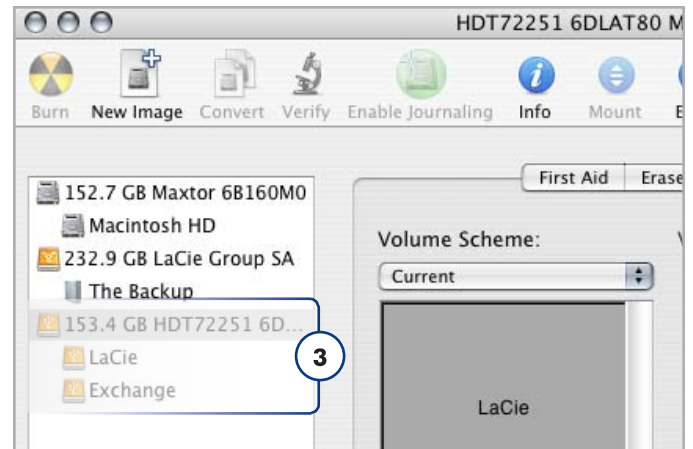

Fig. 14

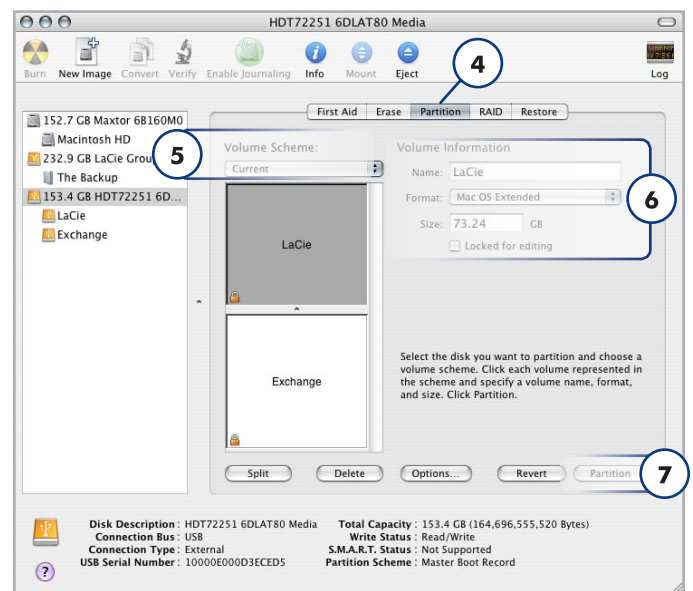

Fig. 15

## 4. Interface and Data Transfer Information

### 4.1. Cables and Connectors

#### 4.1.1. USB 2.0 Cables and Connectors

USB is a serial input/output technology for connecting peripheral devices to a computer or to each other. Hi-Speed USB 2.0 is the latest implementation of this standard, and it provides the necessary bandwidth and data transfer rates to support high speed devices such as hard drives, CD/DVD drives and digital cameras.

##### Included USB Cable

Your LaCie drive is shipped with a Hi-Speed USB 2.0 cable, to ensure maximum data transfer performance when connected to a Hi-Speed USB 2.0 port. The cable will also work when connected to a USB 1.1 port, but drive performance will be limited to USB 1.1 transfer rates.

#### 4.1.2. FireWire Cables and Connectors

FireWire 400, also known as IEEE 1394, is a high-speed serial input/output technology for connecting peripheral devices to a computer or to each other, and FireWire 800 is the implementation of the new IEEE 1394b standard.

FireWire 800 offers increased bandwidth and extended cabling distance between devices. FireWire 800 is ideal for bandwidth-intensive applications, such as audio, video and graphics.

##### Included FireWire Cables

Your LaCie hard disk is shipped with a FireWire 800 (9-9 pin) cable (Fig. 17) and a FireWire 400 to 800 (6-pin to 9-pin) adapter cable (Fig. 18), which will allow you to connect your drive to your computer's FireWire 400 cable. Note that in this case, file transfers will be limited to FireWire 400 speeds.



Fig. 16 – USB Cable Ends



Fig. 17 – FireWire 800 (9-9 pin) cable



Fig. 18 – FireWire 400 to 800 (6-pin to 9-pin) adapter cable

## 4.2. Data Transfers

A data transfer is the flow of data that accomplishes a task, usually related to moving data from storage to computer RAM or between storage devices. During data transfers, it's best to wait before launching other applications on the same USB 2.0 port. Anomalies may arise with computers that have USB 2.0 controllers that do not conform to OHCI (Open Host Controller Interface) standards. In any other configurations, we cannot ensure 100% correct operation.

If you experience hanging problems, proceed as follows:

1. Make sure that the USB 2.0 cable is connected tightly and securely on both ends of the cable, from the drive to the computer. If you are using a USB 2.0 cable other than the one supplied with your LaCie drive, check that it is certified.
2. Disconnect your computer's USB 2.0 cable. Wait 30 seconds. Reconnect.

---

**CAUTION:** Do not connect USB cables so that they form a ring of devices. There is no need for terminators on USB or devices, so the unused USB connectors should be left empty.

---

---

**TECHNICAL INFORMATION:** Controller – A controller is a component or an electronic card (referred to in this case as a “controller card”) that enables a computer to communicate with or manage certain peripherals. An external controller is an expansion card which fills one of the free slots (i.e. PCI or PCMCIA) inside your PC and which enables a peripheral (ex. CD-R/RW drive, scanner or printer) to be connected to the computer. If your computer is not equipped with a USB controller card, you can purchase an external controller through LaCie. Contact your LaCie reseller or LaCie Technical Support (section 6. [Contacting Customer Support](#)) for more information.

---

## 5. Troubleshooting

If your LaCie hard drive is not working correctly, please refer to the following checklist to determine the source of the problem. If you have gone through all of the points on the checklist and your drive still does not work properly, please check the FAQs that are regularly published on our website – [www.lacie.com](http://www.lacie.com). One of these FAQs may provide an answer to your specific question. You can also visit the downloads page, where the most recent software updates will be available.

If you need further assistance, please contact your LaCie reseller or LaCie Customer Support (see section 6. [Contacting Customer Support](#) for details).

### Manual Updates

LaCie strives to give you the most up-to-date, comprehensive user manuals available on the market. It is our goal to provide you with a friendly, easy-to-use format that will help you quickly install and utilize the many functions of your new device.

If your user manual does not reflect the configuration of the product you purchased, please check our website for the most current version of the user manual.

[www.lacie.com](http://www.lacie.com)

### 5.1. Mac Troubleshooting

Problem	Question	Solution
The drive is not recognized by the computer.	Does an icon for the drive appear on the desktop?	There should be an icon for the LaCie drive on the desktop. If the drive does not appear, follow the rest of the Troubleshooting tips to isolate the problem.
	Does your computer's configuration meet the minimum system requirements for use with this drive?	Check page <a href="#">1.1. Minimum System Requirements</a> for more information.
	Did you follow the correct installation steps for the specific interface and operating system?	Review the installation steps on page <a href="#">2.1. Connect the USB Interface Cable</a> .
	Are both ends of the USB cable securely attached?	Check both ends of the USB cable to make sure they are fully seated in their respective ports. Try disconnecting the cables, waiting 10 seconds, and then reconnecting them. If the drive is still not recognized, restart your computer and try again.
	Is the drive receiving sufficient power?	If the LED on the front of the drive is not on, the drive may not be receiving enough power from the USB bus on your computer. Try connecting the USB power sharing cable as described in section <a href="#">2.3. Connect the Optional Power Sharing Cable</a> . Note that this cable is included only with the LaCie Portable Hard Drive USB/FireWire, but it can be purchased from the LaCie website for use with the LaCie Portable Hard Drive USB 2.0.
	Are your computer's USB buses working properly?	Open Apple System Profiler, expand the Hardware list and click on USB. If your device is not listed, recheck the cables and try the other troubleshooting tips listed here.
	Is there a conflict with other device drivers or extensions?	Contact LaCie Technical Support for help.

Problem	Question	Solution
The drive is not recognized by the computer.	Has the drive been formatted?	Make sure that the drive has been formatted properly. Please see section 3. <i>Optional Formatting and Partitioning</i> for more details.
	Does your computer's operating system support the file system?	Check your computer's documentation and see section 3. <i>Optional Formatting and Partitioning</i> for more information.
Error messages under Mac OS 10.x.	Did you get an "Error -50" message while copying to a FAT 32 volume?	When copying files or folders from Mac OS 10.x to a FAT 32 volume, file names with certain characters cannot be copied. These characters include, but are not limited to:  ? < > / \ :  Check your files and folders to ensure that these types of characters are not being used.
	Did you get an error message telling you that the drive has been disconnected when coming out of sleep mode?	Ignore this message. The drive will remount to the desktop. LaCie drives conserve power by spinning down when you set your computer to sleep mode, and when the computer is "revived" from sleep, it does not give the drive enough time to spin up from its sleep mode.
The drive is working slowly.	Are there other USB devices connected to the same port or hub?	Disconnect any other USB devices and see if the drive's performance increases.
The drive is not running noticeably faster when connected via Hi-Speed USB 2.0.	Are you operating in Mac OS 10.x?	Apple has only recently begun incorporating native Hi-Speed USB 2.0 ports in their computers. To achieve Hi-Speed USB 2.0 transfer rates, you will need to add a Hi-Speed USB 2.0 PCI or PC card to your computer.

## 5.2. Windows Troubleshooting

Problem	Question	Solution
The drive is not recognized by the computer.	Has the drive been formatted?	Make sure that the drive has been formatted properly. Please see section 3. <i>Optional Formatting and Partitioning</i> for more details.
	Does your computer's operating system support the file system?	Check your computer's documentation and see section 3. <i>Optional Formatting and Partitioning</i> .
	Is there an icon for the drive in My Computer?	Go into My Computer and look for an icon and drive letter assigned to the LaCie drive. If the drive does not appear, follow the rest of the Troubleshooting tips to isolate the problem.
	Does your computer's configuration meet the minimum system requirements for use with this drive?	See section 1.2. <i>Box Content</i> for more information.

Problem	Question	Solution
The drive is not recognized by the computer.	Is the drive receiving sufficient power?	If the LED on the front of the drive is not on, the drive may not be receiving enough power from the USB bus on your computer. Try connecting the USB power sharing cable as described in section 2.3. <a href="#">Connect the Optional Power Sharing Cable</a> . Note that this cable is included only with the LaCie Portable Hard Drive USB/FireWire, but it can be purchased from the LaCie website for use with the LaCie Portable Hard Drive USB 2.0.
	Did you follow the correct installation steps for the specific interface and operating system?	Review the installation steps on section 2.1. <a href="#">Connect the USB Interface Cable</a> .
	Are both ends of the USB cable securely attached?	Check both ends of the USB cable to make sure they are fully seated in their respective ports. Try disconnecting the cables, waiting 10 seconds, and then reconnecting them. If the drive is still not recognized, restart your computer and try again.
	Is there a conflict with other device drivers or extensions?	Contact LaCie Technical Support for help.
The drive is working slowly.	Are there other USB devices connected to the same port or hub?	Disconnect any other USB devices and see if the drive's performance increases.
The drive is not running noticeably faster when connected via Hi-Speed USB 2.0.	Is the drive connected to a USB 1.1 port on your computer, or to a USB 1.1 hub?	If your drive is connected to a USB 1.1 port or hub, this is normal. A Hi-Speed USB 2.0 device can only operate at Hi-Speed USB 2.0 performance levels when it is connected directly to a Hi-Speed USB 2.0 port or hub. Otherwise, the Hi-Speed USB 2.0 device will operate at the slower USB 1.1 transfer rates.
	Is the drive connected to a Hi-Speed USB 2.0 port on your computer?	Check to see that the Hi-Speed USB 2.0 drivers for both your host bus adapter and device have been installed correctly. If in doubt, uninstall the drivers and re-install them.
	Does your computer or operating system support Hi-Speed USB 2.0?	See section 1.1. <a href="#">Minimum System Requirements</a>

## 6. Contacting Customer Support

### Before You Contact Technical Support

1. Read the manuals and review section [5. Troubleshooting](#).
2. Try to isolate the problem. If possible, make the drive the only external device on the CPU, and make sure that all of the cables are correctly and securely attached.

If you have asked yourself all of the pertinent questions in the troubleshooting checklist, and you still can't get your LaCie drive to work properly, contact us at [www.lacie.com](http://www.lacie.com). Before contacting us, make sure that you are in front of your computer and that you have the following information on hand:

Information	Where to Find Information
LaCie hard drive serial number	Located on a sticker at the back of drive or on the original packaging
Macintosh/PC model	<b>Mac users:</b> Click on the Apple icon in the menu bar and select <b>About This Mac</b> . <b>Windows users:</b> Right click <b>My Computer</b> and select <b>Properties &gt; General</b> .
Operating system version	
Processor speed	
Computer memory	
The brands and models of other internal and external peripherals installed on your computer	
	<b>Mac users:</b> Click on the Apple icon in the finder bar and select <b>About This Mac</b> . Select <b>More Info...</b> The Apple System Profiler will launch and will list your internal and external peripherals. <b>Windows users:</b> Right click <b>My Computer</b> and select <b>Properties &gt; Hardware</b> .

## 6.1. LaCie Technical Support Contacts

LaCie Asia, Singapore, and Hong Kong Contact us at: <a href="http://www.lacie.com/asia/contact/">http://www.lacie.com/asia/contact/</a>	LaCie Australia Contact us at: <a href="http://www.lacie.com/au/contact/">http://www.lacie.com/au/contact/</a>
LaCie Belgium Contact us at: <a href="http://www.lacie.com/be/contact/">http://www.lacie.com/be/contact/</a> (Français)	LaCie Canada Contact us at: <a href="http://www.lacie.com/caen/contact/">http://www.lacie.com/caen/contact/</a> (English)
LaCie Denmark Contact us at: <a href="http://www.lacie.com/dk/contact">http://www.lacie.com/dk/contact</a>	LaCie Finland Contact us at: <a href="http://www.lacie.com/fi/contact/">http://www.lacie.com/fi/contact/</a>
LaCie France Contact us at: <a href="http://www.lacie.com/fr/contact/">http://www.lacie.com/fr/contact/</a>	LaCie Germany Contact us at: <a href="http://www.lacie.com/de/contact/">http://www.lacie.com/de/contact/</a>
LaCie Italy Contact us at: <a href="http://www.lacie.com/it/contact/">http://www.lacie.com/it/contact/</a>	LaCie Japan Contact us at: <a href="http://www.lacie.com/jp/contact/">http://www.lacie.com/jp/contact/</a>
LaCie Netherlands Contact us at: <a href="http://www.lacie.com/nl/contact/">http://www.lacie.com/nl/contact/</a>	LaCie Norway Contact us at: <a href="http://www.lacie.com/no/contact/">http://www.lacie.com/no/contact/</a>
LaCie Spain Contact us at: <a href="http://www.lacie.com/es/contact/">http://www.lacie.com/es/contact/</a>	LaCie Sweden Contact us at: <a href="http://www.lacie.com/se/contact">http://www.lacie.com/se/contact</a>
LaCie Switzerland Contact us at: <a href="http://www.lacie.com/chfr/contact/">http://www.lacie.com/chfr/contact/</a> (Français)	LaCie United Kingdom Contact us at: <a href="http://www.lacie.com/uk/contact/">http://www.lacie.com/uk/contact/</a>
LaCie Ireland Contact us at: <a href="http://www.lacie.com/ie/contact/">http://www.lacie.com/ie/contact/</a>	LaCie USA Contact us at: <a href="http://www.lacie.com/contact/">http://www.lacie.com/contact/</a>
LaCie International Contact us at: <a href="http://www.lacie.com/intl/contact/">http://www.lacie.com/intl/contact/</a>	

## 7. Warranty Information

LaCie warrants your drive against any defect in material and workmanship, under normal use, for the period designated on your warranty certificate. In the event this product is found to be defective within the warranty period, LaCie will, at its option, repair or replace the defective drive. This warranty is void if:

- ◆ The drive was operated/stored in abnormal use or maintenance conditions;
- ◆ The drive is repaired, modified or altered, unless such repair, modification or alteration is expressly authorized in writing by LaCie;
- ◆ The drive was subjected to abuse, neglect, lightning strike, electrical fault, improper packaging or accident;
- ◆ The drive was installed improperly;
- ◆ The serial number of the drive is defaced or missing;
- ◆ The broken part is a replacement part such as a pickup tray, etc.
- ◆ The tamper seal on the drive casing is broken.

LaCie and its suppliers accept no liability for any loss of data during the use of this device, or for any of the problems caused as a result.

LaCie will not, under any circumstances, be liable for direct, special or consequential damages such as, but not limited to, damage or loss of property or equipment, loss of profits or revenues, cost of replacement goods, or expense or inconvenience caused by service interruptions.

Any loss, corruption or destruction of data while using a LaCie drive is the sole responsibility of the user, and under no circumstances will LaCie be held liable for the recovery or restoration of this data.

Under no circumstances will any person be entitled to any sum greater than the purchase price paid for the drive.

To obtain warranty service, call LaCie Technical Support. You will be asked to provide your LaCie product's serial number, and you may be asked to furnish proof of purchase to confirm that the drive is still under warranty.

All drives returned to LaCie must be securely packaged in their original box and shipped with postage prepaid.

---

**IMPORTANT INFO:** Register online for free technical support:  
[www.lacie.com/register](http://www.lacie.com/register)

---