



Capresso Café

Model #115

Pump Espresso and Cappuccino Machine

Operating Instructions
Product Registration
and Warranty

Customer Service 1-800-767-3554

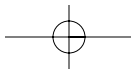
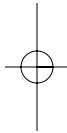
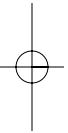
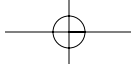

IMPORTANT SAFEGUARDS

When using electrical appliances, basic safety precautions should always be followed, including:

1. Read all instructions.
2. Do not touch hot surfaces. Use handles or knobs.
3. To protect against fire, electrical shock or personal injury, do not immerse cord, plugs or appliance in water or other liquid.
4. Close supervision is necessary when any appliance is used by or near children.
5. Unplug appliance from outlet when not in use and before cleaning. Allow appliance to cool before putting on or taking off parts, and before cleaning the appliance.
6. Do not operate any appliance with a damaged cord or plug or after the appliance malfunctions, or has been damaged in any manner. Return appliance to the nearest authorized service facility for examination, repair, or adjustment.
7. The use of accessory attachments not recommended by the appliance manufacturer may result in fire, electric shock, or injury to persons.
8. Do not use outdoors.
9. Do not let cord hang over edge of table or counter top, or touch any hot surfaces.
10. Do not place on or near a hot gas or electric burner, or in a heated oven.
11. Always attach plug to appliance first, then plug the cord

into the wall outlet. To disconnect, turn any control 'OFF', then remove plug from wall outlet.

12. Do not use appliance for other than intended use.
13. Use extreme caution when dispensing hot steam.
14. For household use only.

SAVE THESE INSTRUCTIONS SPECIAL CORD SET INSTRUCTIONS

1. A short power supply cord (or detachable power-supply cord) is provided to reduce risks resulting from becoming entangled in or tripping over a longer cord.
2. Longer detachable power-supply cords or extension cords are available and may be used if care is exercised in their use.
3. If a longer detachable power-supply cord or extension cord is used,
 - a. The marked electrical rating of the detachable power-supply cord or extension cord must be as great as the electrical rating of the appliance,
 - b. If the appliance is of the grounded type, the extension cord should be a grounding type 3-wire cord, and
 - c. The longer cord should be arranged so that it will not drape over the counter top or table top where it can be pulled on by children or tripped over.

4. This appliance has a polarized plug (one blade is wider than the other). As a safety feature, this plug will fit in a polarized outlet only one way. If the plug does not fit fully in the outlet, reverse the plug. If it still does not fit, contact a qualified electrician. Do not attempt to defeat this safety feature.

CAUTION

This appliance is for household use. Any servicing other than cleaning and user maintenance should be performed by an authorized service agent.

1. Do not immerse in water or try to disassemble appliance.
2. To reduce the risk of fire or electric shock, do not remove the base. No user servicable parts are inside. Repair should be done by authorized service personnel only.
3. Never use warm or hot water to fill the water container. Use cold water only!
4. Keep hands and cord away from hot parts of the appliance during operation.
5. Never clean with scouring powders or hard implements.
6. Operate the appliance with the drip tray and support grid in place.
7. Never heat inflammable liquids using steam.
8. Clean the steam tube only when the appliance is not under pressure and the ON/OFF switch is in the 'OFF' position.
9. Follow the instructions for Decalcifying.

WARNING:

The system is under pressure during operation. Removing the porta filter during operation can cause scalding and injury. Remove the porta filter when brewing is complete, and the appliance is no longer under pressure.

Customer Service

1-800-767-3554

Mon-Thu 9AM – 9PM • Fri 9AM – 8PM • Sat 9AM – 5PM
Eastern Standard Time.
email: contact@capresso.com

Jura-Capresso LLC.

81 Ruckman Road, Closter, NJ 07624
201-767-3999 • Fax: 201-767-9684
Website: www.capresso.com

Table of Contents

	Page		Page
Important Safeguards	3	14. Decalcifying	14
Line Drawing, Fig 1	6	15. Troubleshooting	14
1. The Capresso Café Espresso/Cappuccino Machine	7	16. Recipes	16
2. Before Using for the First Time	7	17. Warranty	17
3. Filling the Water Container	8	18. Customer Service	17
4. Control Panel and Functions	8	Product Registration	19
5. Warming the Internal Components and Cups	10		
6. Filling and Inserting the Porta Filter	10		
7. Preparing Espresso	11		
8. Preparing Cappuccino	11		
9. Cleaning the Frothing Sleeve and Steam Tube	12		
10. Preparing Latte / Heating Other Liquids	12		
11. Delivering Hot Water	13		
12. Turning OFF the Capresso Café	13		
13. Cleaning & Maintenance	13		

APPLIANCE SPECIFICATIONS

Name: Capresso Café

Voltage: 120V 60Hz

Rated Input: 1050 W

Heating System: 1000W thermoblock heater,
thermostat controlled

Pump: 50W electromagnetic high power pump

Pressure: 12-16 bar (max)

Dimensions: 12 x 8 x 11 inches, (303.5 x 203.5 x 274 mm)

Weight: 8.8 lbs, (4 kg)

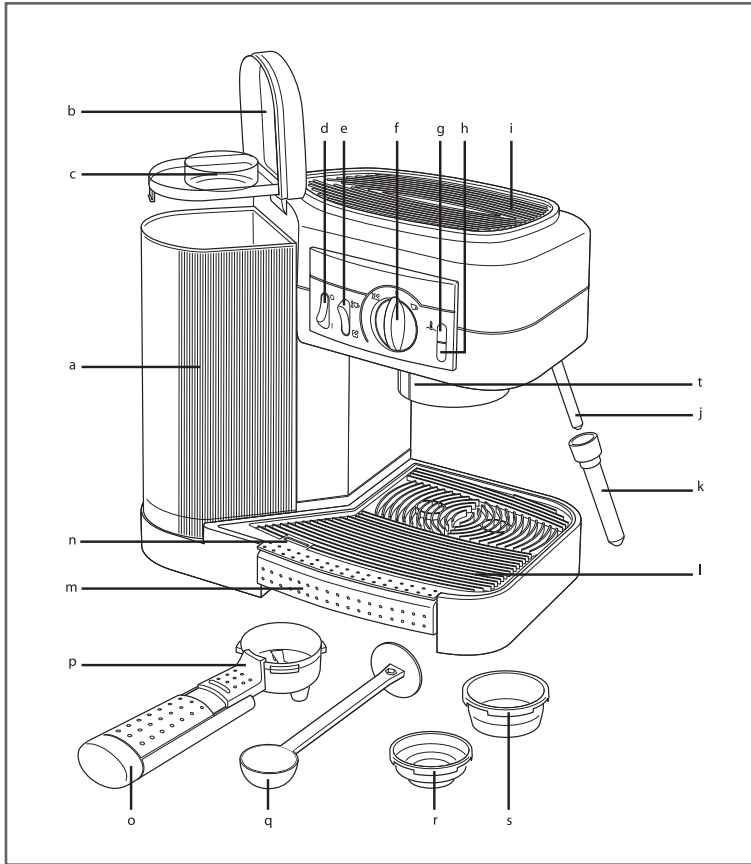

Fig 1, Capresso Café User Components

- a Removable water container
- b Hinged container lid
- c Sieve storage
- d ON/OFF switch
- e Function switch, Coffee or Steam
- f Control dial
- g Heating indicator light (red)
- h Operating indicator light (green)
- i Warming plate for cups
- j Steam tube
- k Removable frothing sleeve
- l Removable grid
- m Removable drip tray
- n Drip tray level indicator
- o Porta filter
- p Filter lock
- q Measuring spoon with tamper and hexagonal key
- r Small sieve, one-cup
- s Large sieve, two-cup
- t Brew head with unlock position indicator

1. The Capresso Café Espresso / Cappuccino Machine

Thank you for purchasing the Capresso Café Espresso and Cappuccino machine. For Warranty and Product Registration please see the end of this booklet.

Experts consider brewing coffee under high pressure to be the ideal process to extract maximum flavor and aroma. The difference between espresso and conventional coffee is that espresso requires a shorter brewing time. This is also that reason that espresso contains approximately 30% less caffeine than conventional filter coffee. If possible, use thick-sided, pre-heated espresso/cappuccino cups which stay hot longer. Add the sugar before pouring espresso into the cup or simply shake some sugar briefly into the cup, stirring just once or twice, otherwise too much flavor escapes.

The Capresso Café produces perfect espresso – coffee with a thick, foamy layer on top called “crema.” The “crema” traps the fine aromatics and the light gaseous flavors that register on the palate. The “crema” keeps flavor locked in that would otherwise escape. The high pressure and short brewing time prevent the extraction of bitter oils and release less caffeine than other brewing methods. Whether you are brewing a small 1 oz. shot of espresso or a larger cup of pressure brewed coffee, your Capresso Café will produce the absolute freshest and most aromatic cup of “crema” coffee possible. Not only will your Capresso Café make the perfect espresso, but within seconds the easy to use frothing system turns your espresso into a

delicious cappuccino. The separate hot water function allows you to make a cup of hot tea or instant soup in 30 seconds.

2. Before Using for the First Time

After carefully unpacking your Capresso Café, wash all removable parts with warm soapy water and rinse thoroughly. Familiarize yourself with the appliance and read the instructions manual.

Plug the power cord into a grounded wall outlet according to the safety instructions.

Rinse the internal components before making espresso. Fill the water container and pump a few ounces of water through the brew head (Fig.1, t) and the steam tube (Fig.1, j). Follow the procedures in chapters 4 and 5 without using coffee.

3. Filling the Water Container

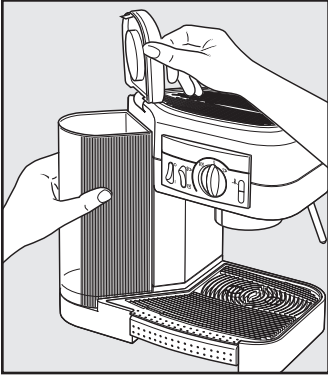

Open the lid and remove the container.



Fill the container every day with fresh, cold water.

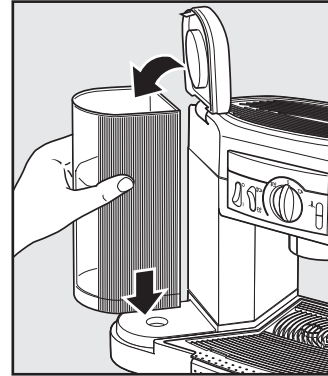

Place the container back into the appliance, pushing down firmly to engage the base valve. Close the lid.

4. Control Panel and Functions

- a) The ON/OFF Switch turns the machine on and off.
- b) The red heating light illuminates while the appliance is heating up. When the operating temperature is reached, the red light turns off and the green “ready” light illuminates.
- c) The Function Switch selects Coffee (through the Brew Head, Fig. 1,t) or Hot Water or Steam (through the Steam Tube, Fig 1, j).
- d) The Control Dial turns the pump on and off and directs the flow of water or steam.

To Brew Espresso:

- Push the Function Switch to Coffee/Hot Water. ☕
- Rotate the Control Dial to the right to deliver Coffee. ☕
- To stop brewing espresso, turn the Control Dial back to 0.

To Deliver Steam:

- Push the Function Switch to Steam. ☕
- Rotate the Control Dial to the left to deliver Steam/Hot Water. ☕
- To stop delivering steam, turn the Control Dial back to 0.

To Deliver Hot Water:

- Push the Function Switch to Coffee/Hot Water. ☕
- Rotate the Control Dial to the left to deliver Hot Water. ☕
- To stop delivering hot water, turn the Control Dial back to 0.

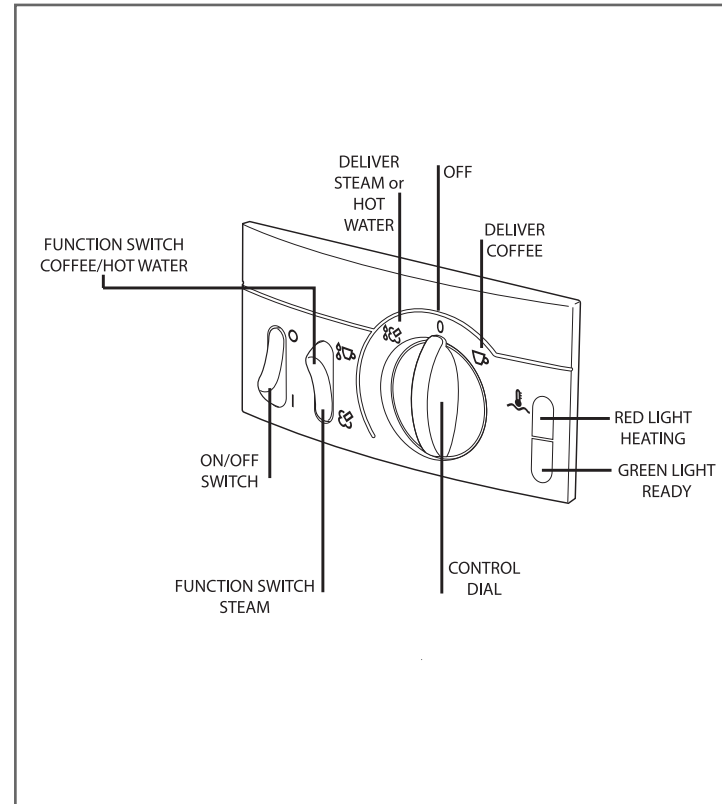

5. Warming Internal Components and Cups

Before making espresso, it is important to pre-warm all the internal components in the appliance and to pre-warm the cups. This procedure will add 10° to 15° F to the first cup of espresso.

- Turn on machine.
- Set the function switch to Coffee/Hot Water.
- Fill the water container with fresh, cold water and place in appliance.
- Insert the porta filter, without coffee and lock into place.
- Place one or two cups underneath the porta filter.
- After the green ready light illuminates, turn the Control Dial to the right to the coffee-delivery position and allow some hot water to pass into the cups.
- Turn the Control Dial back to the 0 position to stop the flow.
- Empty the cups, remove the Porta Filter.

TIP! Place espresso cups upside down on the warming plate to keep them warm. As long as the machine is on, the internal heater will keep the top plate warm.

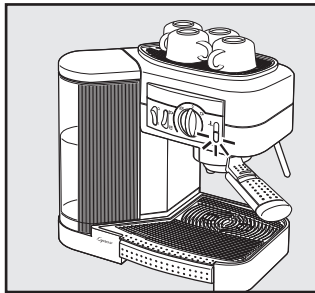

6. Filling and Inserting the Porta Filter

The machine comes with a small (one-cup) and large (two-cup, extra strong) sieve (Fig. 1, r, s). One of them is inserted in the Porta Filter (Fig. 1, o) the other one is stored in the storage compartment (Fig. 1, c).

- Pull back on the filter lock on the porta filter
- Place one of the sieves into the porta filter.
- Ensure the relevant locking cams of the porta filter are always located between the projections on the sieve (see drawing).
- With the measuring spoon, place one or two level spoonfuls of espresso coffee into the sieve.
- Push down, or tamp, the coffee grounds with the tamper side of the measuring spoon.
- Wipe off any coffee grounds of the edge of the porta filter.

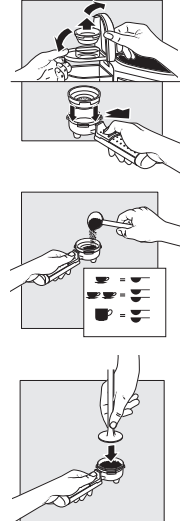

TIP! Do not overfill the porta filter. Use the measuring spoon provided. One level spoonful is sufficient for one cup.

- Pull back the filter lock. Insert and lift the porta filter into the brew head at the unlock position.
- Turn the porta filter to the right until it locks into place.

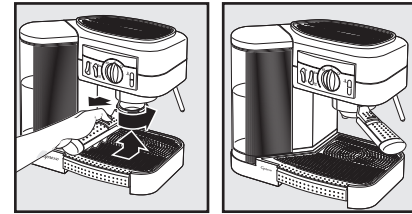

7. Preparing Espresso

- Fill the water container (chapter 3), pre-warm the parts (chapter 5) and fill and insert the Porta Filter (chapter 6).
- Place one or two espresso cups underneath the porta filter.
- When the green ready light illuminates, turn the control dial to the right to the coffee-delivery position.
- When the desired amount of espresso is brewed, stop the flow by turning the control dial to the center position 0.

Note: It is normal for the red heating light to illuminate during brewing indicating the heater is warming the water as it flows through.

- Remove the cups and enjoy.
- Remove the porta filter from the appliance.
- Push the filter lock forward and hold to lock in the sieve.
- Turn the porta filter upside down and tap out the used coffee grounds.
- Rinse sieve under warm water and make sure the holes are free of coffee deposits.
- When the green ready light illuminates, the machine is ready to make the next espresso.

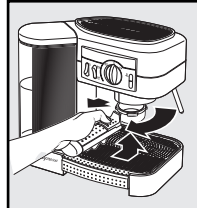
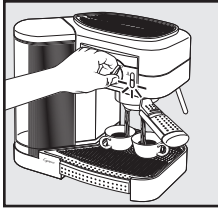
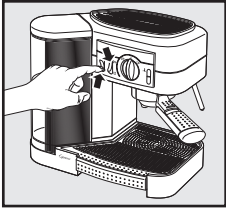

8. Preparing Cappuccino

Cappuccino is the combination of one or two shots of espresso with an equal or larger amount of hot milk and milk froth (for Latte see chapter 10).

Always start with cold milk. Skim or Fat-free milk will produce the most froth and will provide a stronger espresso taste. 1% and 2% milk will produce less froth, and whole milk will produce less than half the amount of froth of skim milk.

- Fill a stainless steel pitcher with 6 to 8 oz. of milk, this will provide enough froth for two to three cups of cappuccino. Make sure that there is enough space left in the pitcher for the milk and milk froth to expand.
- First prepare your espresso (see chapter 8), but use larger, pre-heated cappuccino cups instead of espresso cups.
- Set the function switch to the Steam position. The red heating light illuminates as the appliance is heated to steam temperature.
- Insert and slide the frothing sleeve (Fig. 1, k) onto the steam tube (Fig. 1, j) until it makes contact. The frothing sleeve must click into the groove.
- Turn the frothing sleeve as far as possible to the right to lock it in place.
- The appliance is ready to deliver steam when the green ready light illuminates.

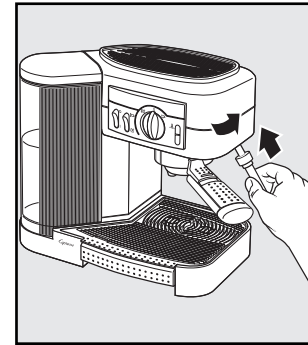

Delivering Steam

TIP! Although it is recommended to use a stainless steel pitcher to froth milk, porcelain or ceramic cups can also be used.

- g) Immerse the frothing sleeve into the milk so that the tip and small side hole is just beneath the surface of the milk. Immersing the frothing sleeve deep into the milk will not allow the tiny bubbles to rise to the surface. It will heat the milk but it will not froth the milk. The frothing sleeve should not come into contact with the base of the milk pitcher while frothing.

Frothing Milk

Note: It is normal for the red heating light to illuminate while frothing. It is also normal for the pump to make ticking noises when making steam.

- h) Turn the control dial to the left to the Steam/Hot Water position. The steaming process will start immediately.
- i) Froth and steam the milk.
- j) To stop dispensing steam, turn the control dial to the center position 0 and remove the pitcher.
- k) Set the froth aside for a few moments to allow the froth to thicken further.
- l) Spoon the frothy milk over the espresso and then fill the remainder of the cup with warmed milk.

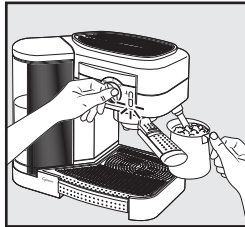

9. Cleaning the Frothing Sleeve and Steam Tube

Note: Clean immediately after use.

- a) Remove the frothing sleeve by turning it as far as possible to the left and then pull it off of steam tube.
- b) Rinse off the remaining milk under running water after each use.

Caution: the frothing sleeve might be hot!

- c) Turn the function switch to the Coffee/Hot Water position.
- d) Place a cup under the steam tube and turn the control dial to the left to the Steam/Hot Water position to rinse the steam tube for a few seconds.
- e) Turn the control dial to 0 to stop the flow of water.

10. Preparing Latte / Heating Other Liquids

Latte is the combination of one or two shots of espresso with an equal or larger amount of hot steamed milk without or very little froth. Prepare your espressos and then add steamed milk (see below).

Producing Steam to Heat Liquids

The steam tube (without the frothing sleeve) can be used to steam milk and heat or re-heat hot beverages, for example hot chocolate, water or tea.

- a) Fill the container with fresh water and place in the appliance.
- b) Make sure the frothing sleeve is removed from the steam tube.
- c) Set the function switch to Steam. When the green ready lights illuminate, the machine is ready to deliver steam.

Note: It is normal for the red heating light to illuminate while delivering steam. It is also normal for the pump to make ticking noises when delivering steam.

- d) Immerse the steam tube into the liquid and turn the Control Dial to the Steam/Hot water position.
- e) When heating is complete, turn the control dial to the center position 0 and remove the cup.

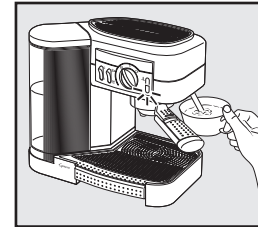

11. Delivering Hot Water

The steam tube (without the frothing sleeve) can be used to deliver hot water for hot drinks, for example, tea or ready-made soups.

Note: If the water is not hot enough, set the Function Switch to Steam to further heat the water with steam (see chapter 10). It is normal for the red heating light to illuminate while delivering hot water. It is also normal for the pump to make ticking noises when making steam.

- Fill the container with water and place in the appliance.
- Remove the frothing sleeve from the steam tube (turn as far as possible to the left and then pull it off the steam tube).
- Set the function switch to Coffee/Hot Water.
- Place or hold a cup underneath the steam tube. Turn the control dial to the left to the Steam/Hot Water position.
- To stop the flow of hot water turn the control dial back to the center 0 position and remove the cup or bowl.

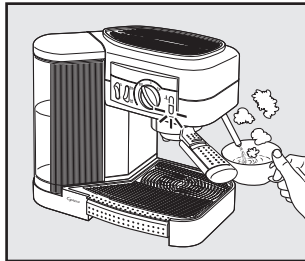

12. Turning OFF the Capresso Café

- Do not switch the appliance off immediately after making the last coffee.
- Wait for a few seconds so that the thermo block heating system can release any left over moisture into the tray. A hissing sound can be heard as the steam expands. This is perfectly normal.

- Now you can turn off the machine.

Note: If the appliance is not used over a longer period of time, remove the Porta Filter. This will extend the life of the seal inside the Brew Head.

13. Cleaning & Maintenance

- Always disconnect the plug from the wall outlet and allow the appliance to cool down before cleaning.
- Do not immerse the appliance in water or any other liquid.
- Do not use harsh abrasives to clean. Wipe down the appliance housing with a damp cloth.
- Wipe the brew head with a damp cloth. Caution hot! Danger of burning or scalding!
- Rinse the fresh water container, the support grid and drip tray regularly with water.
- Empty the drip tray regularly. If the red float fill level indicator (Fig. 1, n) becomes visible through the opening in the support grid, empty drip tray immediately.
- If the inner screen becomes heavily soiled, it can be unscrewed from the brew head, using a coin, for thorough cleaning. Caution hot! Disconnect plug from wall outlet.

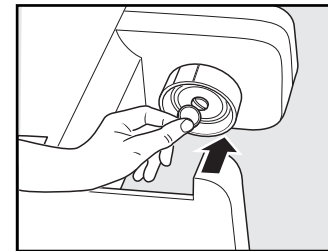
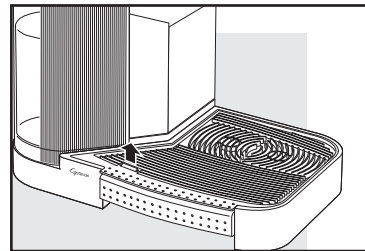

Cleaning the Steam Tube and Frothing Sleeve see chapter 9.

h) If the tip of the steam tube becomes blocked, use the hexagon key on the measuring spoon to remove it. Clean with a needle and replace. In case you lose the tip, there is a spare tip included with the machine.

Decalcifying the Steam Tube

Follow the instructions for 'Decalcifying', (chapter 14) however, set the control dial to the left to the Steam/Hot Water position instead. Remove the frothing sleeve and place a bowl beneath the steam tube.

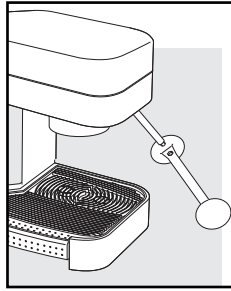

14. Decalcifying

When making espresso, always use cold clean water. Using spring water or filtered water will slow down calcium build up. How often depends on the water hardness; however a good rule would be to decalcify the machine after 200-400 uses.

- Use normal commercial liquid decalcifying agents (follow the instructions for use) or dissolve 4 tablespoons of tartaric acid or citric acid in 30 oz. water. Do not use vinegar as this will considerably shorten the life of the seal.
- Remove the porta filter.
- Unscrew the inner screen from the brew head with a coin.
Wipe off any coffee residue with a damp cloth.
- Fill the container with the decalcifying solution.
- Place a large bowl beneath the brew head.
- Switch ON the appliance and set the function switch to Coffee/Hot Water.

- Turn the control dial to the right to the coffee-delivery position. Allow 1/3 to 1/2 of the solution to be pumped through the system.

Note: There is no need to wait for the green ready light to illuminate.

- Turn OFF the appliance, with the control dial in the coffee-delivery position.
- Allow the solution to take effect for 10-15 minutes.
- Turn ON the appliance and allow the rest of the solution to pass through.
- Important:** After decalcifying, it is absolutely necessary to run 2 tanks full of fresh water through the appliance before putting it back into use.
- Replace inner screen and tighten the screw securely.

15. Troubleshooting

COFFEE RUNS DOWN ON THE SIDE OF THE PORTA FILTER

- Porta filter is not properly in contact position.
Turn the porta filter to the extreme right.
- Edge of sieve not free of ground coffee.
Switch OFF the appliance, remove the porta filter holder and clean the edges of the sieve.
- Sealing ring inside brew head is dirty.
Remove the inner screen with a coin. Remove, clean and replace the sealing ring. Caution hot.
- Sealing ring no longer has elasticity.
Sealing ring must be replaced. See mail order form.

LOUD PUMP NOISE

- A) No water in container.
Fill with water.
- B) Water container not correctly in position.
Raise water container and put into the correct position.

NO OR VERY LITTLE COFFEE COMES THROUGH PORTA FILTER

- A) No water in container.
Fill the container with water.
- B) Function switch set for Steam.
Remove porta filter, set function switch to 0, wait a minute for machine to cool down. Turn function switch to Coffee/Hot Water.
- C) Inner screen is blocked.
*Remove porta filter and allow water to run through inner screen. See section 'Before Using for the First Time'. If necessary, unscrew inner screen and clean.
Caution hot, disconnect plug from wall outlet.*

ESPRESSO BREWS OUT ONLY AS DROPS

- A) Coffee grounds are too fine or packed down too firmly.
Change brand of coffee, do not tamp the coffee grounds so firmly. Use a coarser grind of coffee.
- B) Inner screen is blocked.
*Remove porta filter and allow water to run through inner screen. See chapter 2. If necessary, unscrew inner screen and clean. **Caution hot, disconnect plug from wall outlet.***
- C) Machine blocked by calcium deposits. Decalcify the appliance.
See chapter 14.

NO CREMA

- A) Coffee old or too dry.
Use fresh coffee.
- B) Coffee not pushed down firmly enough.
Tamp coffee grounds more firmly. Use a finer grind.
- C) Coffee too coarse.
Use a finer grind.
- D) Coffee blend not suited to espresso coffee.
Change brand of espresso.

ESPRESSO NOT HOT ENOUGH

See chapter 5.

NO STEAM FROM THE STEAM TUBE

Tip of steam tube is blocked. See chapter 13. If no steam or water comes out of the steam tube, then decalcify the steam tube. If the appliance is still blocked, call Jura-Capresso customer service, see chapter 18.

NOT ENOUGH FROTH WHEN FROTHING MILK

- A) Milk not fresh.
Use fresh milk.
- B) Milk not suitable.
Use milk with no more than 1.5% fat content.
- C) Milk was too warm from the start.
Use milk of fridge temperature.
- D) Not enough milk to froth.
Use more cold milk.

WATER CONTAINER DRIPS WHEN REMOVED

Valve in base may be stuck.

Use finger to push valve back into place.

UNEVEN CUP FILLING

A) Outlet in porta filter blocked.

Clean porta filter.

B) Support grid not level.

Remove, clean and replace support grid.

DIFFICULTY INSERTING PORTA FILTER

Groove on inside of brew head may be soiled by coffee ground residue.

*Disconnect plug from wall outlet, wipe down groove with damp cloth. **Caution hot!***

ESPRESSO TASTES BITTER

Appliance has not been rinsed properly after decalcifying.

Run 2 containers full of fresh water through the appliance. See chapter 14.

APPLIANCE DOES NOT OPERATE (NO POWER)

Mechanical or electronic defect.

Call the Jura-Capresso Customer Service, see chapter 18.

MISSING PARTS

See Mail Order Form or call the Jura-Capresso Customer Service, see chapter 18.

16. Recipes

Espresso:

1 1/2 to 2 ounces, add sugar to taste.

Espresso ristretto:

small, strong, about 1 ounce

Espresso lungo:

medium and less concentrated, 2 to 2 1/2 ounces

Cappuccino:

Prepare one or two shots of espresso in a pre-warmed cappuccino cup. Add steamed and frothed milk to taste. Garnish with cocoa powder or chocolate sprinkles.

Latte: Prepare one or two shots of espresso in a large cup.

Prepare steamed milk. Fill the remainder of the cup with warmed milk.

Italian-style Iced Coffee:

Ingredients: 4 scoops of vanilla ice-cream; 1/2 cup of milk; 2 cups of cold, sweetened espresso; chocolate sprinkles.

Mix the milk and espresso, pour over the ice-cream and decorate with the chocolate sprinkles.

Espresso flambé:

Ingredients: 5 measures of brandy; 2 teaspoons of brown sugar, 2 cups of espresso; whipping cream.

Pour the brandy into heat-resistant glasses, heat and then set alight. Add sugar and stir. Pour espresso over the top and garnish with a topping of whipped cream.

17. LIMITED ONE-YEAR WARRANTY

This warranty covers your CAPRESSO machine, model #115 espresso machine. The model # can be found on the bottom of the machine. This warranty is in effect for one year from the date of the first consumer purchase and is limited to the United States of America. This warranty covers all defects in materials or workmanship (parts and labor) This warranty does not cover:

- Any machine not distributed by JURA-CAPRESSO within the United States.
- Any machine not purchased from an Authorized JURA-CAPRESSO Dealer.
- Commercial use of machine.
- Damage caused by accident, abuse, negligence, misuse, improper operation or failure to follow instructions contained in this manual.
- Any service or alteration performed by an unauthorized person, company, or association.

Other limitations and exclusions: Any implied warranties including fitness for use and merchantability are limited in duration to the period of the express warranty set forth above and no person is authorized to assume for JURA-CAPRESSO any other liability in connection with the sale of the machine. JURA-CAPRESSO expressly disclaims liability for incidental and consequential damages caused by the machine. The term “incidental damages” refers to the loss of the original purchasers time, loss of the use of the machine or other costs relating to the care and custody of the machine. The term “consequential

damages” refers to the cost of repairing or replacing other property which is damaged when this machine does not work properly. The remedies provided under this warranty are exclusive and in lieu of all others. This warranty gives you specific legal rights, and you may also have other rights which vary from state to state.

18. JURA-CAPRESSO CUSTOMER SERVICE:

JURA-CAPRESSO Inc.
81 Ruckman Road
CLOSTER, NJ 07624

Help Line: 1-800-767-3554
9AM to 9PM Monday through Friday
9AM to 5PM Saturday Eastern Standard Time.

If you call at any other time, please leave a message with your telephone number and when we can call you back.

Fax: 201-767-9684

Email: contact@capresso.com

Website: www.capresso.com

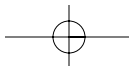
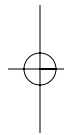
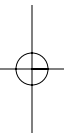
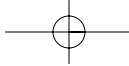



Capresso Café, Model #115 Product Registration

Please complete this registration after you have used your machine for a few days. Your information will help us to better serve you in the future.

Thank you for buying from JURA-CAPRESSO.

Please print clearly

Last Name _____

First Name _____

Male Female

Address _____

City _____ State _____ Zip _____

Your Email Address _____

Purchased from:

Specialty store Mail order Department store

Internet company Received as gift

Name of retailer _____

Purchase Date _____ Purchase Price \$ _____

Reasons for buying this product:

- Concept/Features
- Saw it on TV
- Print advertising
- Retailer recommendation
- Recommended by a friend

Do you use an espresso/cappuccino machine regularly?

- Yes
- No

I drink (mark all that applies):

- Regular coffee
- Cappuccino
- Latte
- Espresso
- Hot Chocolate

What other espresso machine did you use before?

- None
- Krups
- Salton
- Gaggia
- DeLonghi
- Breville
- Cuisinart
- Other: _____

Would you like more information about our products? Yes No

Your annual household income: Under \$50,000

\$50,000 – \$100,000 \$100,000 – \$250,000 \$250,000 +

Your age group: Under 25 25–40 41–45 46–55

56–65 65 +

Any suggestions on how we can improve this product?

Would you recommend this product to your friends? Yes No

Mail to JURA-CAPRESSO Inc.,
P.O. Box 775, CLOSTER, NJ 07624
or FAX to: (201) 767-9684.