

# DENON

AV SURROUND RECEIVER

# AVR-589

---

Owner's Manual

Manuel de l'Utilisateur

SAFETY PRECAUTIONS



**CAUTION**

**RISK OF ELECTRIC SHOCK**

**DO NOT OPEN**



**CAUTION:**  
**TO REDUCE THE RISK OF ELECTRIC SHOCK, DO NOT REMOVE COVER (OR BACK). NO USER-SERVICEABLE PARTS INSIDE. REFER SERVICING TO QUALIFIED SERVICE PERSONNEL.**

The lightning flash with arrowhead symbol, within an equilateral triangle, is intended to alert the user to the presence of uninsulated "dangerous voltage" within the product's enclosure that may be of sufficient magnitude to constitute a risk of electric shock to persons.

The exclamation point within an equilateral triangle is intended to alert the user to the presence of important operating and maintenance (servicing) instructions in the literature accompanying the appliance.

**WARNING:**  
**TO REDUCE THE RISK OF FIRE OR ELECTRIC SHOCK, DO NOT EXPOSE THIS APPLIANCE TO RAIN OR MOISTURE.**

# SAFETY INSTRUCTIONS

1. Read Instructions – All the safety and operating instructions should be read before the product is operated.
2. Retain Instructions – The safety and operating instructions should be retained for future reference.
3. Heed Warnings – All warnings on the product and in the operating instructions should be adhered to.
4. Follow Instructions – All operating and use instructions should be followed.
5. Cleaning – Unplug this product from the wall outlet before cleaning. Do not use liquid cleaners or aerosol cleaners.
6. Attachments – Do not use attachments not recommended by the product manufacturer as they may cause hazards.
7. Water and Moisture – Do not use this product near water – for example, near a bath tub, wash bowl, kitchen sink, or laundry tub; in a wet basement; or near a swimming pool; and the like.
8. Accessories – Do not place this product on an unstable cart, stand, tripod, bracket, or table. The product may fall, causing serious injury to a child or adult, and serious damage to the product. Use only with a cart, stand, tripod, bracket, or table recommended by the manufacturer, or sold with the product. Any mounting of the product should follow the manufacturer's instructions, and should use a mounting accessory recommended by the manufacturer.
9. A product and cart combination should be moved with care. Quick stops, excessive force, and uneven surfaces may cause the product and cart combination to overturn.
10. Ventilation – Slots and openings in the cabinet are provided for ventilation and to ensure reliable operation of the product and to protect it from overheating, and these openings must not be blocked or covered. The openings should never be blocked by placing the product on a bed, sofa, rug, or other similar surface. This product should not be placed in a built-in installation such as a bookcase or rack unless proper ventilation is provided or the manufacturer's instructions have been adhered to.
11. Power Sources – This product should be operated only from the type of power source indicated on the marking label. If you are not sure of the type of power supply to your home, consult your product dealer or local power company. For products intended to operate from battery power, or other sources, refer to the operating instructions.
12. Grounding or Polarization – This product may be equipped with a polarized alternating-current line plug (a plug having one blade wider than the other). This plug will fit into the power outlet only one way. This is a safety feature. If you are unable to insert the plug fully into the outlet, try reversing the plug. If the plug should still fail to fit, contact your electrician to replace your obsolete outlet. Do not defeat the safety purpose of the polarized plug.
13. Power-Cord Protection – Power-supply cords should be routed so that they are not likely to be walked on or pinched by items placed upon or against them, paying particular attention to cords at plugs, convenience receptacles, and the point where they exit from the product.
15. Outdoor Antenna Grounding – If an outside antenna or cable system is connected to the product, be sure the antenna or cable system is grounded so as to provide some protection against voltage surges and built-up static charges. Article 810 of the National Electrical Code, ANSI/NFPA 70, provides information with regard to proper grounding of the mast and supporting structure, grounding of the lead-in wire to an antenna discharge unit, size of grounding conductors, location of antenna-discharge unit, connection to grounding electrodes, and requirements for the grounding electrode. See Figure A.
16. Lightning – For added protection for this product during a lightning storm, or when it is left unattended and unused for long periods of time, unplug it from the wall outlet and disconnect the antenna or cable system. This will prevent damage to the product due to lightning and power-line surges.
17. Power Lines – An outside antenna system should not be located in the vicinity of overhead power lines or other electric light or power circuits, or where it can fall into such power lines or circuits. When installing an outside antenna system, extreme care should be taken to keep from touching such power lines or circuits as contact with them might be fatal.
18. Overloading – Do not overload wall outlets, extension cords, or integral convenience receptacles as this can result in a risk of fire or electric shock.
19. Object and Liquid Entry – Never push objects of any kind into this product through openings as they may touch dangerous voltage points or short-out parts that could result in a fire or electric shock. Never spill liquid of any kind on the product.
20. Servicing – Do not attempt to service this product yourself as opening or removing covers may expose you to dangerous voltage or other hazards. Refer all servicing to qualified service personnel.
21. Damage Requiring Service – Unplug this product from the wall outlet and refer servicing to qualified service personnel under the following conditions:
  - a) When the power-supply cord or plug is damaged,
  - b) If liquid has been spilled, or objects have fallen into the product,
  - c) If the product has been exposed to rain or water,
  - d) If the product does not operate normally by following the operating instructions. Adjust only those controls that are covered by the operating instructions as an improper adjustment of other controls may result in damage and will often require extensive work by a qualified technician to restore the product to its normal operation,
  - e) If the product has been dropped or damaged in any way, and
  - f) When the product exhibits a distinct change in performance – this indicates a need for service.
22. Replacement Parts – When replacement parts are required, be sure the service technician has used replacement parts specified by the manufacturer or have the same characteristics as the original part. Unauthorized substitutions may result in fire, electric shock, or other hazards.
23. Safety Check – Upon completion of any service or repairs to this product, ask the service technician to perform safety checks to determine that the product is in proper operating condition.
24. Wall or Ceiling Mounting – The product should be mounted to a wall or ceiling only as recommended by the manufacturer.
25. Heat – The product should be situated away from heat sources such as radiators, heat registers, stoves, or other products (including amplifiers) that produce heat.

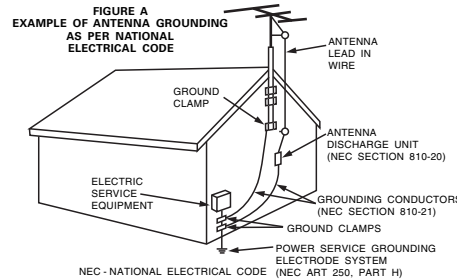

### FCC INFORMATION (For US customers)

#### 1. PRODUCT

This product complies with Part 15 of the FCC Rules. Operation is subject to the following two conditions: (1) this product may not cause harmful interference, and (2) this product must accept any interference received, including interference that may cause undesired operation.

#### 2. IMPORTANT NOTICE: DO NOT MODIFY THIS PRODUCT

This product, when installed as indicated in the instructions contained in this manual, meets FCC requirements. Modification not expressly approved by DENON may void your authority, granted by the FCC, to use the product.

#### 3. NOTE

This product has been tested and found to comply with the limits for a Class B digital device, pursuant to Part 15 of the FCC Rules. These limits are designed to provide reasonable protection against harmful interference in a residential installation.

This product generates, uses and can radiate radio frequency energy and, if not installed and used in accordance with the instructions, may cause harmful interference to radio communications. However, there is no guarantee that interference will not occur in a particular installation. If this product does cause harmful interference to radio or television reception, which can be determined by turning the product OFF and ON, the user is encouraged to try to correct the interference by one or more of the following measures:

- Reorient or relocate the receiving antenna.
- Increase the separation between the equipment and receiver.
- Connect the product into an outlet on a circuit different from that to which the receiver is connected.
- Consult the local retailer authorized to distribute this type of product or an experienced radio/TV technician for help.

This Class B digital apparatus complies with Canadian ICES-003.  
Cet appareil numérique de la classe B est conforme à la norme NMB-003 du Canada.

### NOTE ON USE / OBSERVATIONS RELATIVES A L'UTILISATION

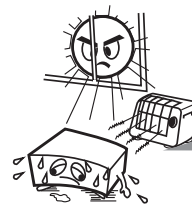

- Avoid high temperatures. Allow for sufficient heat dispersion when installed in a rack.
- Eviter des températures élevées. Tenir compte d'une dispersion de chaleur suffisante lors de l'installation sur une étagère.



- Keep the unit free from moisture, water, and dust.
- Protéger l'appareil contre l'humidité, l'eau et la poussière.



- Do not let foreign objects into the unit.
- Ne pas laisser des objets étrangers dans l'appareil.

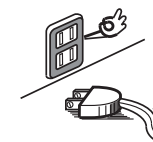

- Unplug the power cord when not using the unit for long periods of time.
- Débrancher le cordon d'alimentation lorsque l'appareil n'est pas utilisé pendant de longues périodes.

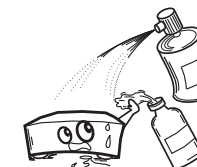

- Do not let insecticides, benzene, and thinner come in contact with the unit.
- Ne pas mettre en contact des insecticides, du benzène et un diluant avec l'appareil.

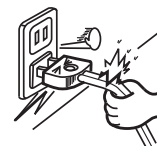

- Handle the power cord carefully. Hold the plug when unplugging the cord.
- Manipuler le cordon d'alimentation avec précaution. Tenir la prise lors du débranchement du cordon.



\* (For apparatuses with ventilation holes)

- Do not obstruct the ventilation holes.
- Ne pas obstruer les trous d'aération.



- Never disassemble or modify the unit in any way.
- Ne jamais démonter ou modifier l'appareil d'une manière ou d'une autre.

## □ Contents

### Getting Started

<b>Accessories</b> .....	2
<b>Cautions on Handling</b> .....	3
<b>Cautions on Installation</b> .....	3
<b>About the Remote Control Unit</b> .....	3
Inserting the Batteries .....	3
Operating Range of the Remote Control Unit .....	3
<b>Part Names and Functions</b> .....	4
Front Panel .....	4
Display .....	4
Rear Panel .....	5
Remote Control Unit .....	6

### Connections

<b>Preparations</b> .....	7
Cables Used for Connections .....	7
<b>Speaker Connections</b> .....	8
Speaker Installation .....	8
Speaker Connections .....	9
<b>Connecting Equipment with HDMI connectors</b> .....	10
<b>Connecting the Monitor</b> .....	11
<b>Connecting the Playback Components</b> .....	11
DVD Player .....	11
CD Player .....	12
iPod® .....	12
TV/CABLE Tuner .....	12
<b>Connecting the Recording Components</b> .....	13
Video Cassette Recorder .....	13
CD Recorder / MD Recorder / Tape Deck .....	13
<b>Connections to Other Devices</b> .....	13
Video Camera / Game Console .....	13
Component with Multi-channel Output connectors .....	14
SIRIUS connector .....	14
Antenna terminals .....	15
<b>Connecting the Power Cord</b> .....	15
<b>Once Connections are Completed</b> .....	15

### Operations

<b>Menu Map</b> .....	16
<b>Examples of Front Display</b> .....	16

### Auto Setup

<b>Preparations</b> .....	17
<b>Auto Setup</b> .....	18
<b>1</b> Auto Setup .....	18
<b>2</b> Error Messages .....	19

### System Setup

<b>System Setup Operation</b> .....	20
<b>Example of Display of Default Values</b> .....	20
<b>1. Speaker Setup</b> .....	21
<b>1 ~ 4</b> Speaker Configuration .....	21
<b>5</b> Subwoofer Mode Setup .....	21
<b>6 ~ 11</b> Distance .....	22
<b>12 ~ 16</b> Crossover Frequency .....	22
<b>17</b> Test Tone .....	22
<b>18</b> Restore .....	23
<b>2. Input Setup</b> .....	23
<b>1, 2</b> HDMI In Assign .....	23
<b>3 ~ 6</b> Digital In Assign .....	24
<b>7</b> iPod Assign .....	24
<b>8</b> Audio Delay .....	24
<b>9</b> EXT. IN Subwoofer Level .....	24
<b>10</b> Auto Preset Memory .....	24
<b>11</b> Parental Lock .....	25
<b>12</b> Edit Lock Code .....	25
<b>3. Option Setup</b> .....	26
<b>1 ~ 3</b> Volume Control .....	26
<b>4</b> Auto Surround Mode .....	26
<b>5</b> Direct Mode Setup .....	26
<b>6</b> Remote ID Setup .....	26

### Surround Modes

<b>① Standard Playback</b> .....	27
Surround Playback of 2-channel Sources .....	27
Playing Multi-channel Sources (Dolby Digital, DTS, etc.) .....	27
<b>② DSP Simulation Playback</b> .....	28
<b>③ Direct Playback</b> .....	28
<b>④ Stereo Playback</b> .....	28

### Parameter

<b>Adjusting the parameters</b> .....	29
<b>Surround Parameter</b> .....	29
<b>1</b> Mode .....	30
<b>2</b> Cinema EQ .....	30
<b>3</b> D.Comp (Dynamic Range Compression) .....	30
<b>4</b> LFE .....	30
<b>5</b> Center Image .....	30
<b>6</b> Panorama .....	30
<b>7</b> Dimension .....	30
<b>8</b> Center Width .....	30
<b>9</b> Delay Time .....	30
<b>10</b> Effect Level .....	30
<b>11</b> Room Size .....	30
<b>12</b> SW ATT (Subwoofer Attenuation) .....	31
<b>13</b> Subwoofer .....	31
<b>14</b> Tone Control .....	31
<b>15</b> Bass .....	31
<b>16</b> Treble .....	31
<b>17</b> MultEQ .....	31
<b>18</b> Dynamic EQ .....	31
<b>19</b> Dynamic Volume .....	32
<b>20</b> DV Setting (Dynamic Volume Setting) .....	32
<b>21</b> RESTORER .....	32
<b>22</b> Night Mode .....	33
<b>23</b> Default .....	33

<b>Information</b> .....	33
--------------------------	----

**Playback**

**Preparations**.....34  
 Turning the Power On.....34  
 Selecting the Input Source.....34  
 Setting the Input Mode.....34  
 Operations During Playback.....35  
**Playing Video and Audio Equipment**.....35  
 Basic Operation.....35  
**Listening to FM/AM Broadcasts**.....36  
 Basic Operation.....36  
 Presetting Radio Stations (Preset Memory).....36  
 Listening to Preset Stations.....36  
**Listening to SIRIUS Satellite Radio Programs**.....37  
 Basic Operation.....37  
 Checking the SIRIUS Signal Strength and Radio ID.....37  
 Searching Categories.....38  
 Parental Lock.....38  
**iPod® Playback**.....38  
 Preparations.....38  
 Listening to Audio.....39  
 Viewing Still Pictures or Videos on the iPod.....39

**Other Operations and Functions**

**Other Operations**.....40  
 Recording on an External Device (REC OUT mode).....40  
**Convenient Functions**.....40  
 Channel Level.....40  
 Quick Select Function.....41  
 Personal Memory Plus Function.....41  
 Last Function Memory.....41  
 Backup Memory.....41  
 Resetting the Microprocessor.....41

**Remote Control Unit Operations**

**Operating DENON Audio Components**.....42  
**Presetting**.....42  
**Operating Preset Components**.....42  
**Punch Through Function**.....44

**Other Information**..... 45

**Troubleshooting**..... 50

**Specifications**..... 52

**List of preset codes**..... End of this manual

**Getting Started**

Thank you for purchasing this DENON product. To ensure proper operation, please read this owner's manual carefully before using the product. After reading them, be sure to keep them for future reference.

**Accessories**

Check that the following parts are supplied with the product.

- ① Owner's manual ..... 1
- ② Getting Started ..... 1
- ③ Warranty (for North America model only)..... 1
- ④ Service station list ..... 1
- ⑤ Remote control (RC-1104)..... 1
- ⑥ R6/AA batteries ..... 2
- ⑦ FM indoor antenna ..... 1
- ⑧ AM loop antenna ..... 1
- ⑨ Setup microphone (DM-A409, Cord length: Approx. 25 ft / 7.6 m) ..... 1

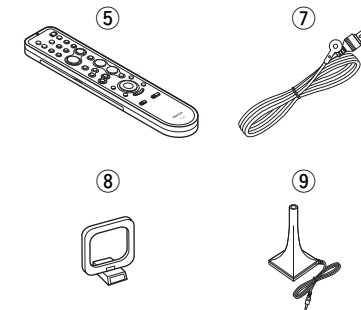

## Cautions on Handling

- **Before turning the power switch on**  
Check once again that all connections are correct and that there are no problems with the connection cables.
- Power is supplied to some of the circuitry even when the unit is set to the standby mode. When traveling or leaving home for long periods of time, be sure to unplug the power cord from the power outlet.
- **About condensation**  
If there is a major difference in temperature between the inside of the unit and the surroundings, condensation (dew) may form on the operating parts inside the unit, causing the unit not to operate properly.  
If this happens, let the unit sit for an hour or two with the power turned off and wait until there is little difference in temperature before using the unit.
- **Cautions on using mobile phones**  
Using a mobile phone near this unit may result in noise. If so, move the mobile phone away from this unit when it is in use.
- **Moving the unit**  
Turn off the power and unplug the power cord from the power outlet.  
Next, disconnect the connection cables to other system units before moving the unit.
- Note that the illustrations in these instructions may differ from the actual unit for explanation purposes.

## Cautions on Installation

### Note:

For proper heat dispersal, do not install this unit in a confined space, such as a bookcase or similar enclosure.

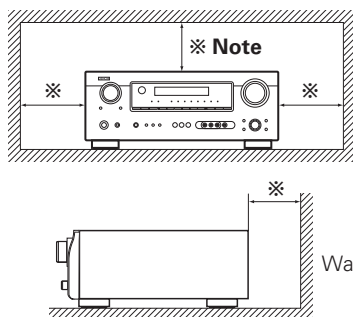

## About the Remote Control Unit

In addition to the AVR-589, the included remote control unit (RC-1104) can also be used to operate the equipment listed below.

- ① DENON system components
- ② Non-DENON system components
  - By setting the preset memory (☞ page 42 ~ 44)

## Inserting the Batteries

- ① Lift the clasp and remove the rear lid.

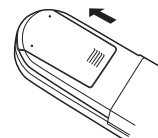

- ② Load the two batteries properly as indicated by the marks in the battery compartment.

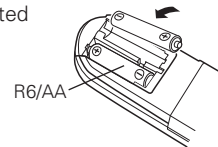

- ③ Put the rear cover back on.

### NOTE

- Replace the batteries with new ones if the set does not operate even when the remote control unit is operated close to the unit.
- The supplied batteries are only for verifying operation.
- When inserting the batteries, be sure to do so in the proper direction, following the “⊕” and “⊖” marks in the battery compartment.
- To prevent damage or leakage of battery fluid:
  - Do not use a new battery together with an old one.
  - Do not use two different types of batteries.
  - Do not attempt to charge dry batteries.
  - Do not short-circuit, disassemble, heat or dispose of batteries in flames.
- If the battery fluid should leak, carefully wipe the fluid off the inside of the battery compartment and insert new batteries.
- Remove the batteries from the remote control unit if it will not be in use for long periods.
- When replacing the batteries, have the new batteries ready and insert them as quickly as possible.

## Operating Range of the Remote Control Unit

Point the remote control unit at the remote sensor when operating it.

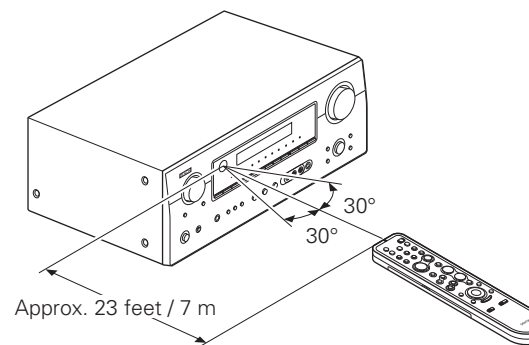

### NOTE

The set may function improperly or the remote control unit may not operate if the remote control sensor is exposed to direct sunlight, strong artificial light from an inverter type fluorescent lamp or infrared light.



# Part Names and Functions

For buttons not explained here, see the page indicated in parentheses ( ).

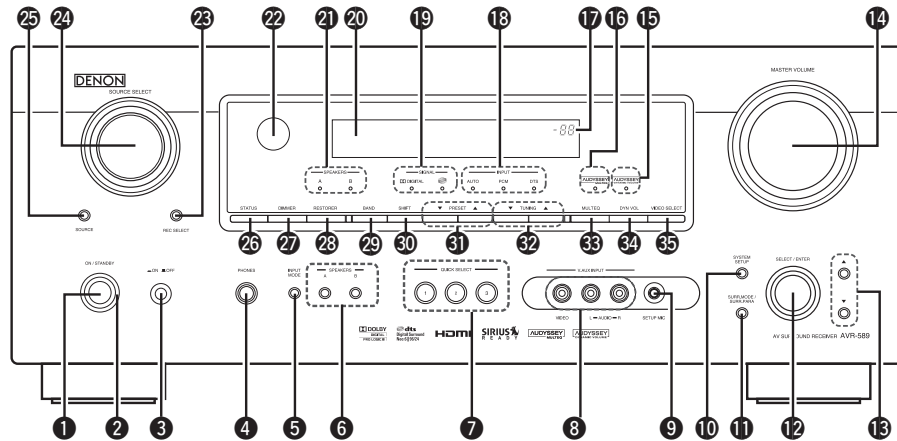
## Front Panel

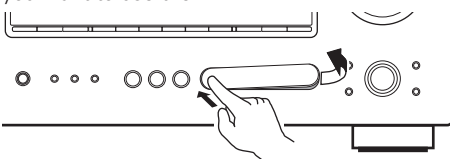

- 1 Power operation button (ON/STANDBY) ..... (34)
- 2 Power indicator ..... (34)
- 3 Power switch (ON/OFF) ..... (34, 41)
- 4 Headphone jack (PHONES) ..... (35)
- 5 INPUT MODE button ..... (34)
- 6 SPEAKERS buttons ..... (35, 41)
- 7 QUICK SELECT buttons ..... (41)
- 8 V. AUX INPUT connectors  
Remove the cap covering the connectors when you want to use them.  

- 9 SETUP MIC jack ..... (17)
- 10 SYSTEM SETUP button ..... (20)
- 11 SURR. MODE / SURR. PARA button ..... (27, 29)

- 12 SELECT/ENTER knob  
  
• The SELECT/ENTER knob on the main unit operates in the same way as the cursor ◀ and ▶ buttons on the remote control unit.  
  
• The control functions in the same way as the cursor ◀ button when turned counterclockwise, as the cursor ▶ button when turned clockwise.  
• The control functions in the same way as the ENTER button when pressed the knob.
- 13 Cursor buttons (Δ▽) ..... (20)
- 14 MASTER VOLUME control knob ..... (35)
- 15 Dynamic Volume indicator ..... (32)
- 16 MultEQ indicator ..... (31)
- 17 Master volume indicator

- 18 INPUT mode indicators ..... (34)
- 19 SIGNAL indicators
- 20 Display
- 21 SPEAKERS indicators ..... (35)
- 22 Remote control sensor ..... (3)
- 23 REC SELECT button ..... (40)
- 24 SOURCE SELECT knob ..... (34)
- 25 SOURCE button ..... (34)
- 26 STATUS button ..... (33)
- 27 DIMMER button ..... (35)
- 28 RESTORER button ..... (32)
- 29 BAND button ..... (36)
- 30 SHIFT button ..... (36)
- 31 PRESET CHANNEL buttons (▲▼) ..... (36)
- 32 TUNING buttons (▲▼) ..... (36)
- 33 MULTEQ button ..... (31)
- 34 DYNAMIC VOLUME button ..... (32)  
\* About Dynamic Volume  
Audyssey Dynamic Volume™ solves the problem of large variations in volume level between television programs, commercials, and between the soft and loud passages of movies. Audyssey Dynamic EQ™ is integrated into Dynamic Volume so that as the playback volume is adjusted automatically, the perceived bass response, tonal balance, surround impression, and dialog clarity remain the same.  
\* About Dynamic EQ  
Audyssey Dynamic EQ solves the problem of deteriorating sound quality as volume is decreased by taking into account human perception and room acoustics. Audyssey Dynamic EQ works in tandem with Audyssey MultEQ® to provide well-balanced sound for every listener at any volume level.
- 35 VIDEO SELECT button ..... (35)

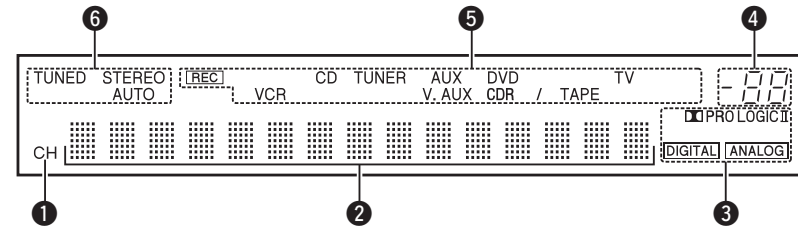
## Display



- 1 Signal channel indicator  
Lights when the preset channel is displayed at 2.
- 2 Information display
- 3 Input signal indicators
- 4 Master volume indicator  
This displays the volume level. The Setup item number is displayed in System Setup.
- 5 Recording output source indicator  
This lights when the REC OUT mode is selected. (This indicator is off when "SOURCE" is selected.)
- 6 Tuner reception mode indicators  
These light according to the reception conditions when the input source is set to "TUNER".  
• AUTO  
This lights when in the auto tuning mode.  
• STEREO  
In the FM mode, this lights when receiving analog stereo broadcasts.  
• TUNED  
This lights when the broadcast is properly tuned in.

Rear Panel

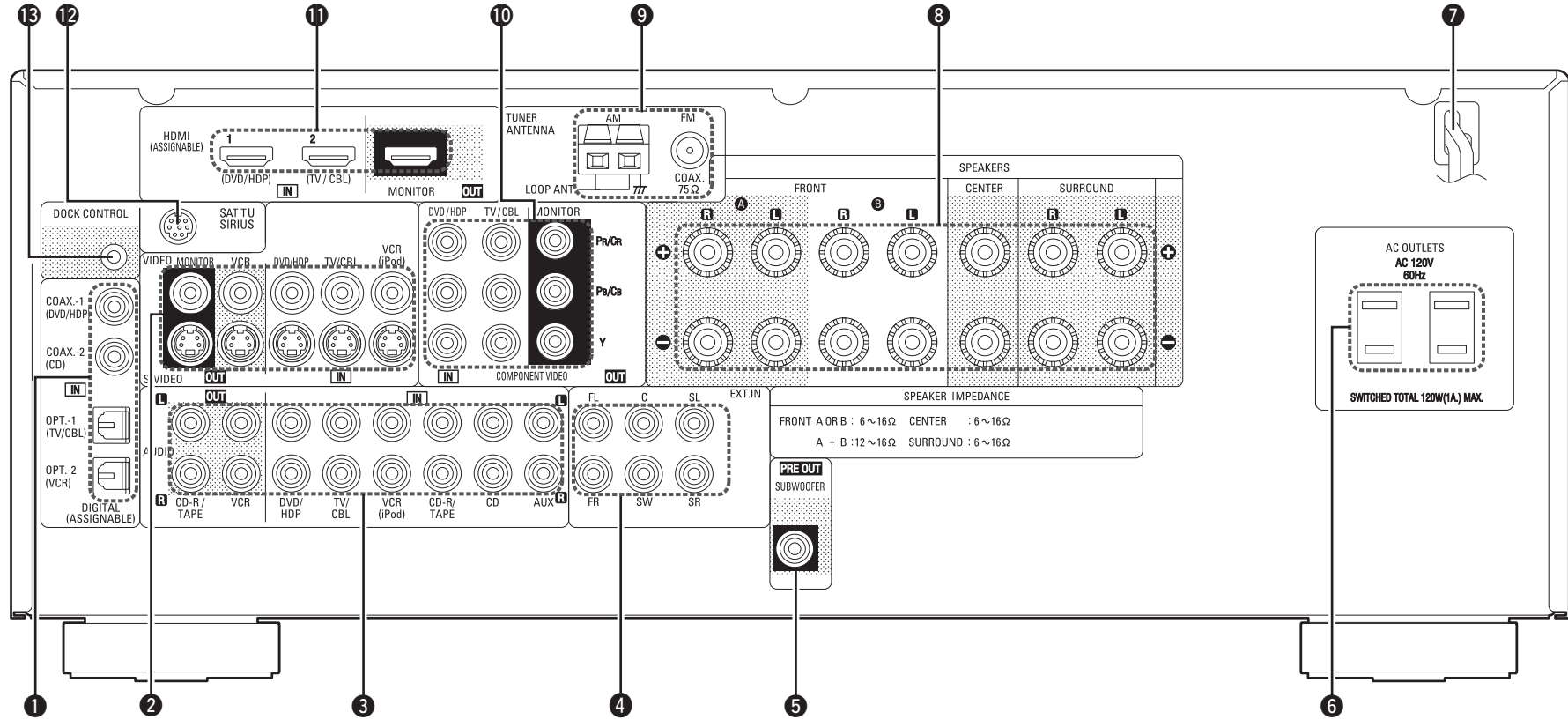

- |   |  |
|---|--|
| <p>① Digital audio connectors (OPTICAL / COAXIAL) ..... (10 ~ 12, 14)</p> <p>② VIDEO / S-VIDEO connectors ..... (11 ~ 13)</p> <p>③ Analog audio connectors (AUDIO) ..... (10 ~ 13)</p> <p>④ EXT. IN connectors ..... (14)</p> <p>⑤ PRE OUT connector ..... (9)</p> <p>⑥ AC OUTLETS ..... (15)</p> | <p>⑦ Power cord ..... (15)</p> <p>⑧ Speaker terminals (SPEAKERS) ..... (9)</p> <p>⑨ FM/AM antenna terminals (TUNER ANTENNA) ..... (15)</p> <p>⑩ COMPONENT VIDEO connectors ..... (11, 12)</p> <p>⑪ HDMI connectors ..... (10 ~ 12)</p> <p>⑫ SIRIUS connector (SAT TU) ..... (14)</p> <p>⑬ DOCK CONTROL jack ..... (12)</p> |
|---|--|

Remote Control Unit

[ Front ]

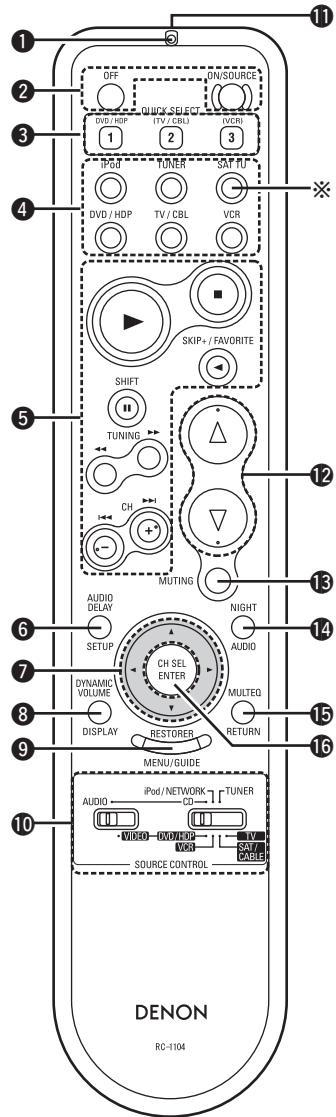

- ❶ Indicator ..... (42)
- ❷ Power buttons ..... (34)
- ❸ QUICK SELECT buttons ..... (41)
- ❹ Source select buttons ..... (34)  
※ : To select "SIRIUS" as the input source, use the SAT TU button.
- ❺ System buttons ..... (39, 43)
- ❻ AUDIO DELAY button ..... (24)
- ❼ Cursor buttons (Δ▽◀▶) ..... (20)
- ❽ DYNAMIC VOLUME button ..... (32)
- ❾ RESTORER button ..... (32)
- ❿ SOURCE CONTROL switches ..... (36)
- ⓫ Remote control signal transmitter
- ⓬ Master volume control buttons ..... (35)
- ⓭ MUTING button ..... (35)
- ⓮ NIGHT button ..... (33)
- ⓯ MULTEQ button ..... (31)
- ⓰ Channel select (CH SEL) / ENTER button ..... (20, 40)

[ Rear ]

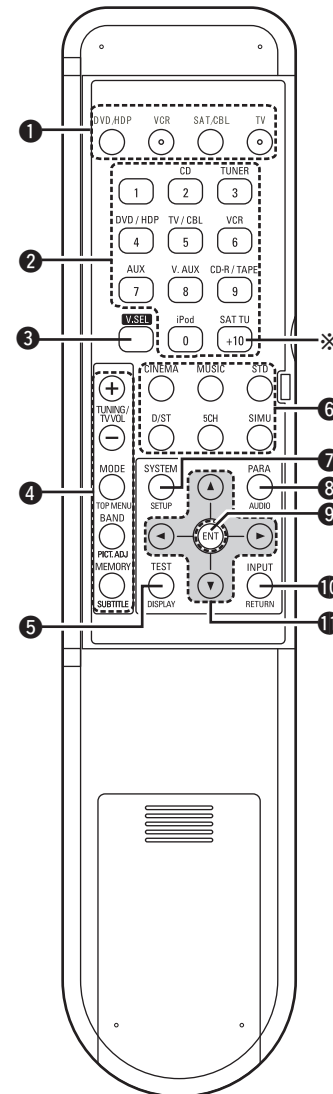

- ❶ Power buttons ..... (44)
- ❷ Source select buttons ..... (34)  
※ : To select "SIRIUS" as the input source, use the SAT TU button.
- ❸ Video select button (V.SEL) ..... (35)
- ❹ Tuner system buttons ..... (36)
- ❺ Test tone button (TEST) ..... (23)
- ❻ Surround mode buttons ..... (27, 28, 30)
- ❼ System setup button (SYSTEM) ..... (20)
- ❽ Surround parameter button (PARA) ... (27, 29)
- ❾ Enter button (ENT) ..... (20)
- ❿ Input mode button (INPUT) ..... (34)
- ⓫ Cursor buttons (Δ▽◀▶) ..... (20)

NOTE

If buttons on the front or rear are pressed strongly, the button on the opposite side will be activated too.

# Connections

Connections for all compatible audio and video signal formats are described in this owner's manual. Please select the types of connections suited for the equipment you are connecting.

With some types of connections, certain settings must be made on the AVR-589. For details, refer to the instructions for the respective connection items below.



























































































**NOTE**

- Do not plug in the power cord until all connections have been completed.
- When making connections, also refer to the operating instructions of the other components.
- Be sure to connect the left and right channels properly (left with left, right with right).
- Do not bundle power cords together with connection cables. Doing so can result in humming or noise.

## Preparations

### Cables Used for Connections

Select the cables according to the equipment being connected.

Audio cables	Video cables								
<p><b>Coaxial digital connections</b></p> <p>(Orange)   </p> <p>Coaxial digital (75 Ω/ohms pin-plug) cable</p> <p><b>Optical digital connections</b></p> <p>  </p> <p>Optical cable</p> <p><b>Analog connections (stereo)</b></p> <p>(White)   </p> <p>(Red)   </p> <p>Stereo pin-plug cable</p> <p><b>Analog connections (monaural, for subwoofer)</b></p> <p>(Black)   </p> <p>Pin-plug cable</p> <p><b>Speaker connections</b></p> <p>  </p> <p>Speaker cables</p>	<p><b>Component video connections</b></p> <p>(Green)    (Y)</p> <p>(Blue)    (PB/Cb)</p> <p>(Red)    (PR/CR)</p> <p>Component video cable</p> <p><b>S-Video connections</b></p> <p>  </p> <p>S-Video cable</p> <p><b>Video connections</b></p> <p>(Yellow)   </p> <p>75 Ω/ohms pin-plug video cable</p> <tr> <th colspan="2" style="background-color: #cccccc;">Audio and video cables</th> </tr> <tr> <td colspan="2"> <p><b>HDMI connections</b></p> <p>  </p> <p>19-pin HDMI cable</p> <tr> <th colspan="2" style="background-color: #cccccc;">Signal direction</th> </tr> <tr> <td> <p>Audio signal:</p> <p>Output </p> <p>Input </p> <p>Input </p> <p>Output </p> </td> <td> <p>Video signal:</p> <p>Output </p> <p>Input </p> <p>Input </p> <p>Output </p> </td> </tr> </td></tr>	Audio and video cables		<p><b>HDMI connections</b></p> <p>  </p> <p>19-pin HDMI cable</p> <tr> <th colspan="2" style="background-color: #cccccc;">Signal direction</th> </tr> <tr> <td> <p>Audio signal:</p> <p>Output </p> <p>Input </p> <p>Input </p> <p>Output </p> </td> <td> <p>Video signal:</p> <p>Output </p> <p>Input </p> <p>Input </p> <p>Output </p> </td> </tr>		Signal direction		<p>Audio signal:</p> <p>Output </p> <p>Input </p> <p>Input </p> <p>Output </p>	<p>Video signal:</p> <p>Output </p> <p>Input </p> <p>Input </p> <p>Output </p>
Audio and video cables									
<p><b>HDMI connections</b></p> <p>  </p> <p>19-pin HDMI cable</p> <tr> <th colspan="2" style="background-color: #cccccc;">Signal direction</th> </tr> <tr> <td> <p>Audio signal:</p> <p>Output </p> <p>Input </p> <p>Input </p> <p>Output </p> </td> <td> <p>Video signal:</p> <p>Output </p> <p>Input </p> <p>Input </p> <p>Output </p> </td> </tr>		Signal direction		<p>Audio signal:</p> <p>Output </p> <p>Input </p> <p>Input </p> <p>Output </p>	<p>Video signal:</p> <p>Output </p> <p>Input </p> <p>Input </p> <p>Output </p>				
Signal direction									
<p>Audio signal:</p> <p>Output </p> <p>Input </p> <p>Input </p> <p>Output </p>	<p>Video signal:</p> <p>Output </p> <p>Input </p> <p>Input </p> <p>Output </p>								

# Speaker Connections

## Speaker Installation

The illustration below shows a basic example of installation of the amplifier combined with 6 speakers and a monitor.

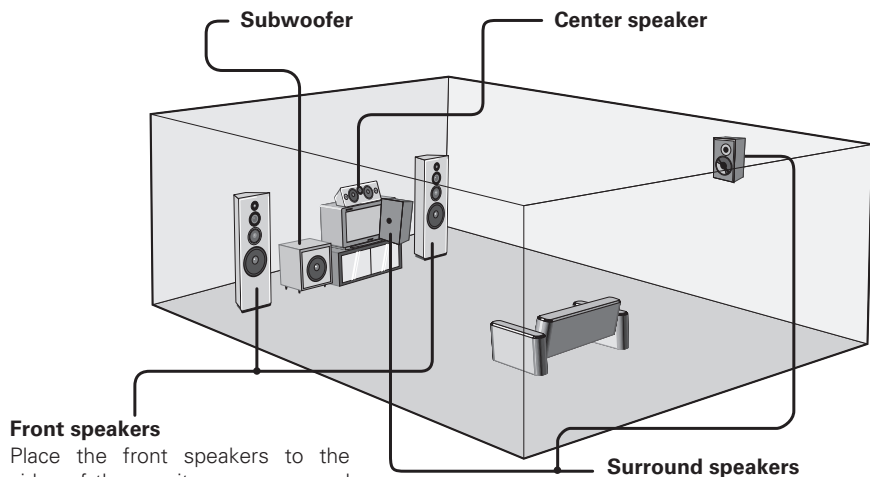

**Front speakers**

Place the front speakers to the sides of the monitor or screen and as flush with the screen surface as possible.



The table below shows a typical speaker configuration for the AVR-589.

	FRONT		CENTER	SURROUND		SUBWOOFER
	L	R		L	R	
5.1-channels	○	○	○	○	○	○
3.1-channels	○	○	○	-	-	○
2.1-channels	○	○	-	-	-	○
2-channels	○	○	-	-	-	-

# Speaker Connections

Example: 5.1-channels

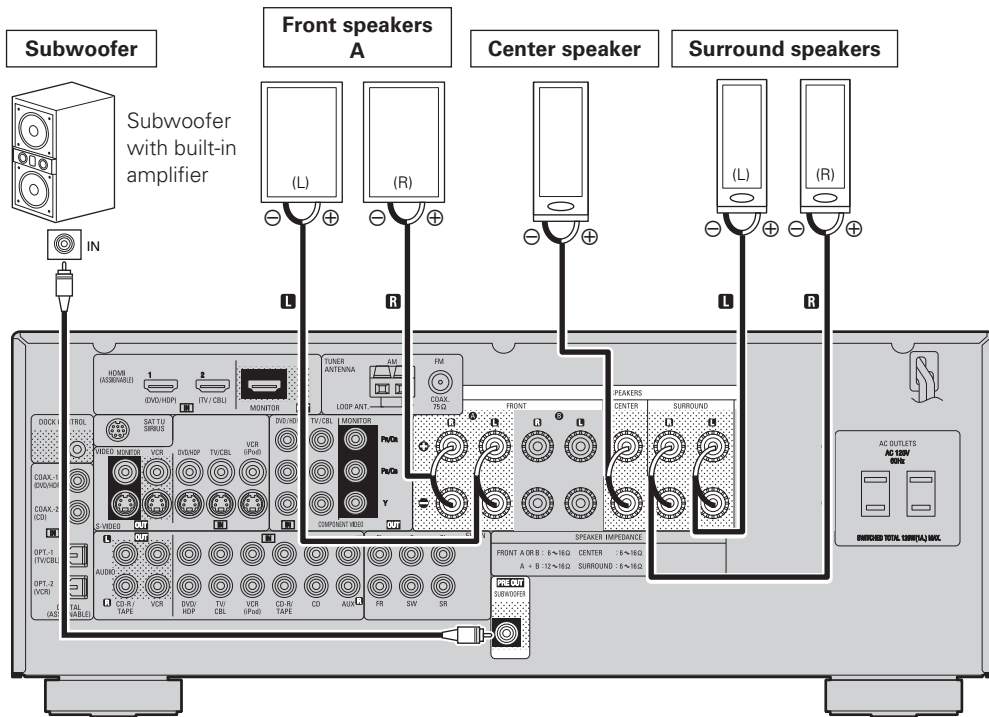

※ L : Left  
R : Right

## Connecting the Speaker Cables

Carefully check the left (L) and right (R) channels and + (red) and - (black) polarities on the speakers being connected to the AVR-589, and be sure to interconnect the channels and polarities correctly.

**1** Peel off about 0.03 ft/10 mm of sheathing from the tip of the speaker cable, then either twist the core wire tightly or terminate it.



**2** Turn the speaker terminal counterclockwise to loosen it.



**3** Insert the speaker cable's core wire to the hilt into the speaker terminal.



**4** Turn the speaker terminal clockwise to tighten it.



### When using a banana plug

Tighten the speaker terminal firmly before inserting the banana plug.



### NOTE

- Use speakers with an impedance of 6 to 16 Ω/ohms. When using front A and B speakers simultaneously, use speakers with an impedance of 12 to 16 Ω/ohms.
- Connect the speaker cables in such a way that they do not stick out of the speaker terminals. The protection circuit may be activated if the core wires touch the rear panel or if the + and - sides touch each other (☞ "Protection circuit").
- Never touch the speaker terminals while the power supply is connected. Doing so could result in electric shock.

### Protection circuit

If the core wires touch the rear panel and the screws etc., or the ± sides touch each other, the protection circuit will be activated and the power indicator will flash red at intervals of 0.5 secs.

If the protection circuit is activated, the speaker output is isolated, and the power supply goes to the standby state. If the power supply is turned off, after the power supply cord is withdrawn, please confirm that speaker cable and input cable are connected.

Also, if replaying large sound levels by using a speaker having an impedance less than that specified (eg. 4 Ω/ohms), the temperature will rise, and the protection circuit might be activated. The power supply will go into the standby state, and the power indicator will flash red at 2 second intervals.

In this case, please switch off the power supply, and wait until the AVR-589 has cooled down, and the surrounding ventilation is good.

Even if there are no problems with the surrounding ventilation and connections, in the event of the protection circuit becoming activated, due to thinking that the AVR-589 has failed, please contact DENON Service center after switching off.

## Connecting Equipment with HDMI connectors

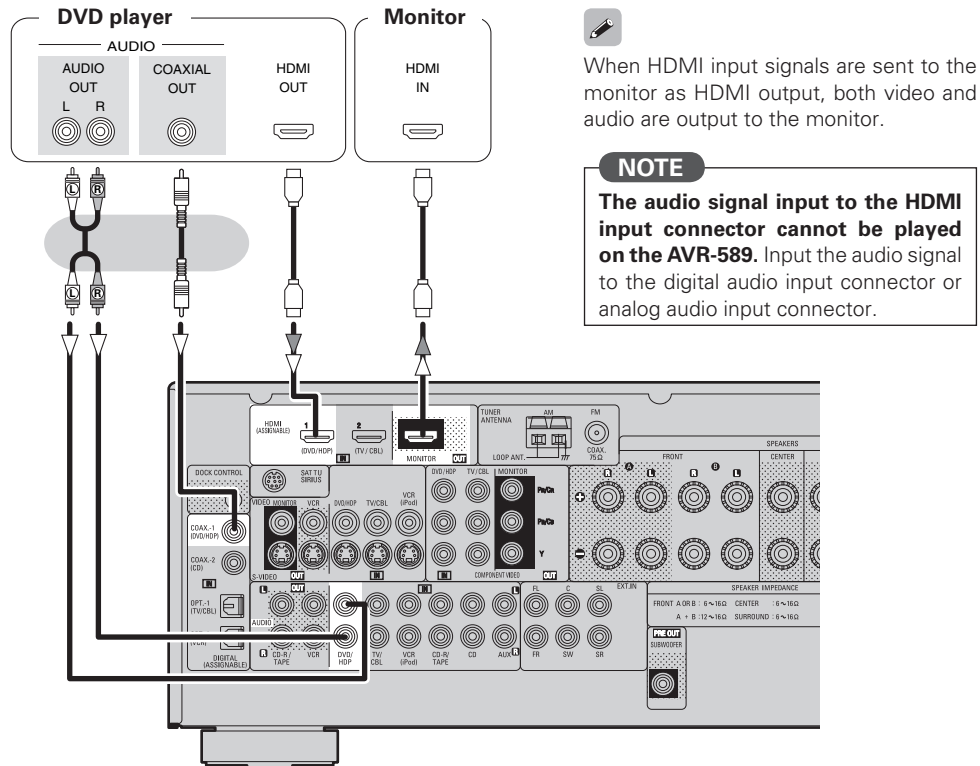

When HDMI input signals are sent to the monitor as HDMI output, both video and audio are output to the monitor.

### NOTE

**The audio signal input to the HDMI input connector cannot be played on the AVR-589.** Input the audio signal to the digital audio input connector or analog audio input connector.

### NOTE

- The AVR-589 cannot be controlled from another device via the HDMI cable.
- Video signals are not output if the input video signals do not match the monitor's resolution. In this case, switch the DVD player's resolution to a resolution with which the monitor is compatible.
- Use a cable on which the HDMI logo is indicated (a certified HDMI product) for connection to the HDMI connector. Normal playback may not be possible when using a cable other than one on which the HDMI logo is indicated (a non-HDMI-certified product).
- If the monitor or DVD player does not support Deep Color, deep color signal transfer is not possible.
- If the monitor or DVD player does not support xvYCC, xvYCC signal transfer is not possible.



- The audio and video signals input to the AVR-589's HDMI input connector are output unchanged from the HDMI output connector. Because of this, the sound is output from the monitor connected using the HDMI connectors, but in order to take full advantage of the AVR-589's playback sound, turn the TV's volume down.
- If the connected monitor or DVD player only has a DVI-D connector, use an HDMI/DVI converter cable. **When using a DVI cable, no audio signals are transmitted.**
- Use a Deep Color compatible cable for connection to Deep Color compatible devices.

### When connecting with an HDMI/DVI converter cable (adapter)

- HDMI video signals are theoretically compatible with the DVI format. When connecting to a monitor, etc., equipped with a DVI-D connector, connection is possible using an HDMI/DVI converter cable, but depending on the combination of components in some cases the video signals will not be output.
- When connecting using an HDMI/DVI converter adapter, the video signals may not be output properly due to poor connections with the connected cable, etc.

- ※ The AVR-589 is equipped for HDMI version 1.3a. This version is compatible with other versions, allowing connection to all components equipped with an HDMI connector.
- ※ The AVR-589 is compatible with 30- and 36-bit Deep Color.
- ※ The AVR-589 can be connected to a device equipped with an HDMI output connector using an HDMI cable.
- ※ The AVR-589 is compatible with HDMI Ver. 1.3a Deep Color and xvYCC.

## Connecting the Monitor

Select the terminal to use and connect the device.

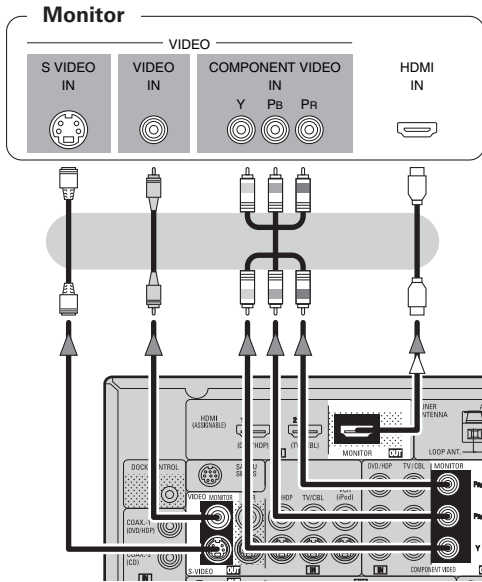

[Flow of video signals inside the AVR-589]

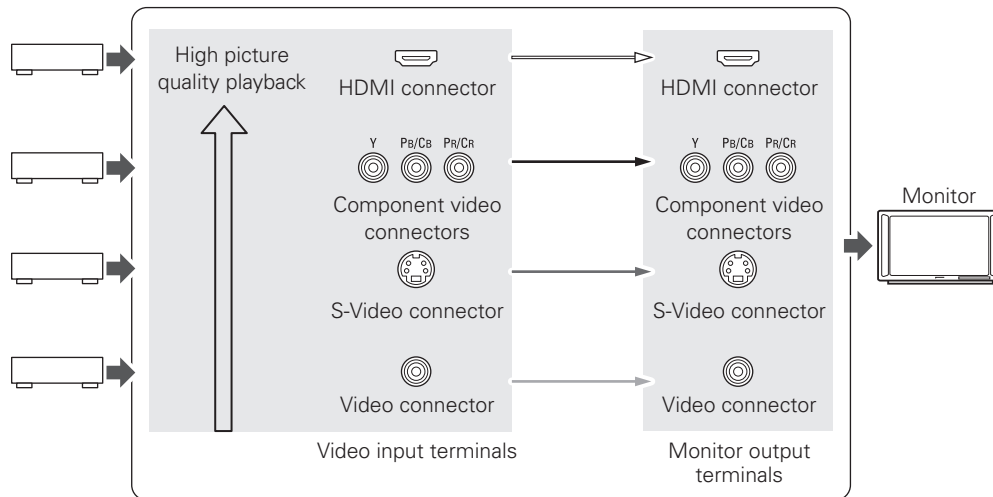

### NOTE

- The AVR-589 supports four video input formats: HDMI, component video, S-video and video. Because video signals are output from the AVR-589's monitor output terminal in the same format as the video input signals, **the monitor output terminal should be of the same type as the terminal used for input.**
- The component video connectors may be indicated differently on your monitor. For details, see the monitor's operating instructions.
- To play the sound by AVR-589, make analog or digital audio output connections to AVR-589's audio input connectors.

## Connecting the Playback Components

Carefully check the left (L) and right (R) channels and the inputs and outputs, and be sure to interconnect correctly.

### DVD Player

Select the terminal to use and connect the device.

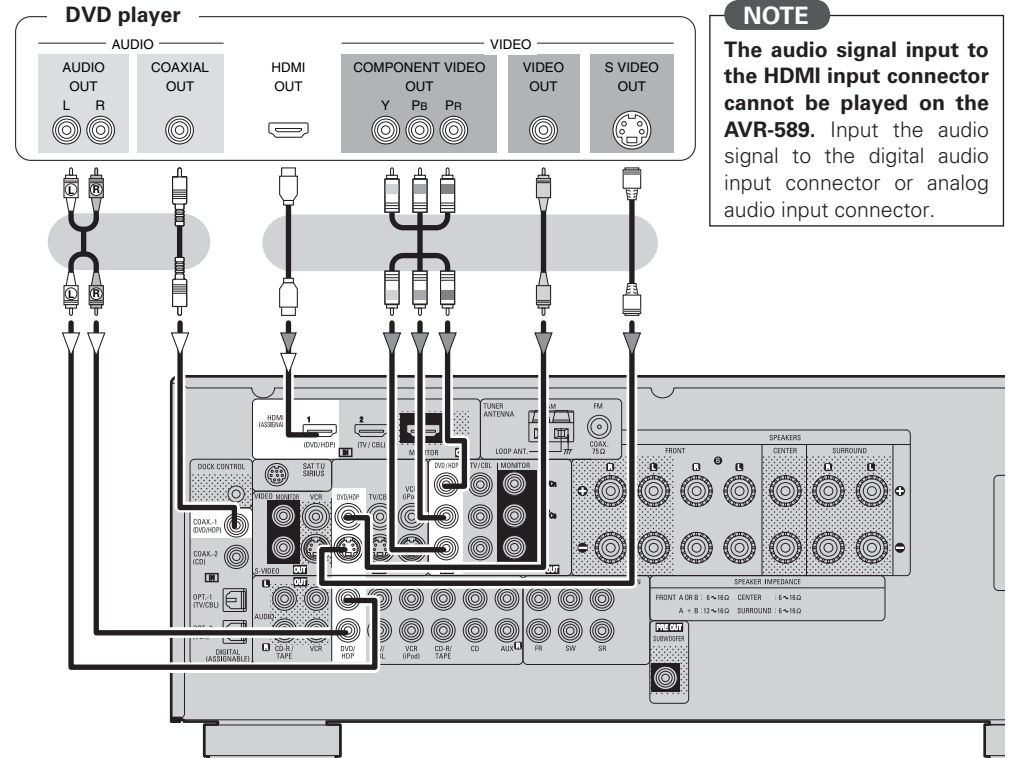

### NOTE

**The audio signal input to the HDMI input connector cannot be played on the AVR-589.** Input the audio signal to the digital audio input connector or analog audio input connector.



- The same method can be used to connect an HDP (High-Definition Player) such as a Blu-ray Disc player.
- When using an optical cable for the digital audio connection, make the settings at "System Setup" - "Input Setup" - "Digital In Assign" (page 24).

### NOTE

Because video signals are output from the AVR-589's monitor output terminal in the same format as the video input signals, **the monitor output terminal should be of the same type as the terminal used for input.**

### CD Player

Select the terminal to use and connect the device.

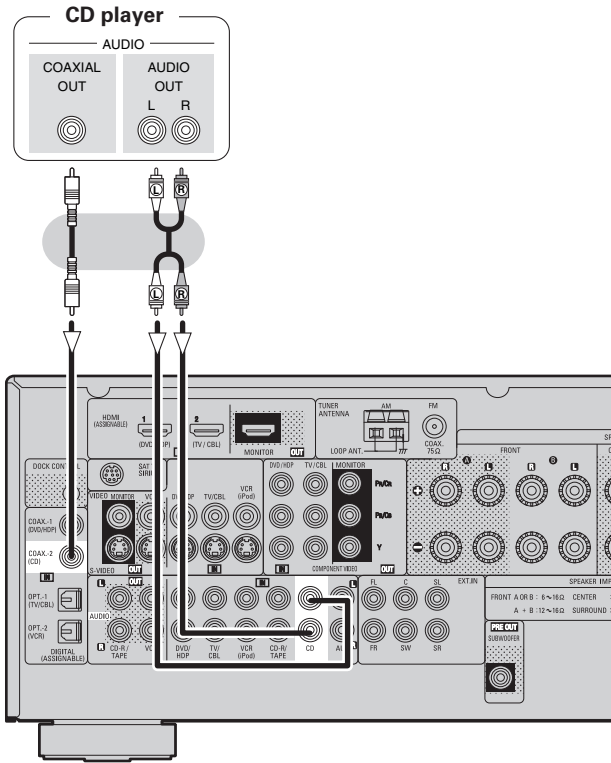

When using an optical cable for the digital audio connection, make the settings at "System Setup" – "Input Setup" – "Digital In Assign" (page 24).

### iPod®

Use a DENON control dock for iPod (ASD-1R, ASD-3N or ASD-3W, sold separately) to connect the iPod to the AVR-589. For instructions on the control dock for iPod settings, refer to the control dock for iPod's operating instructions.

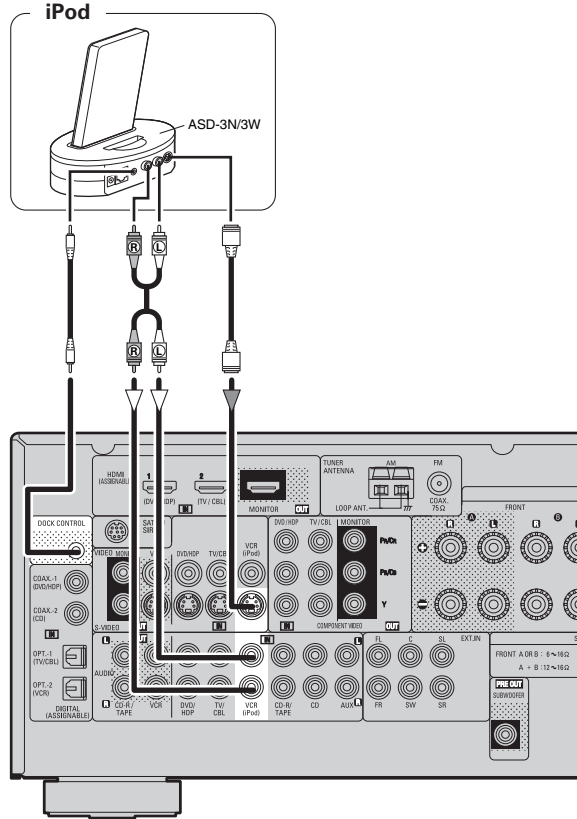

- With the default settings, the iPod can be used connected to the VCR (iPod) connector.
- To assign the iPod to a connector other than VCR (iPod), make the settings at "System Setup" – "Input Setup" – "iPod Assign" (page 24).

#### NOTE

**Video/S-Video or Component Video connections are required to playback iPod Video or Photos on TV monitor.**

### TV/CABLE Tuner

Select the terminal to use and connect the device.

#### NOTE

**The audio signal input to the HDMI input connector cannot be played on the AVR-589. Input the audio signal to the digital audio input connector or analog audio input connector.**

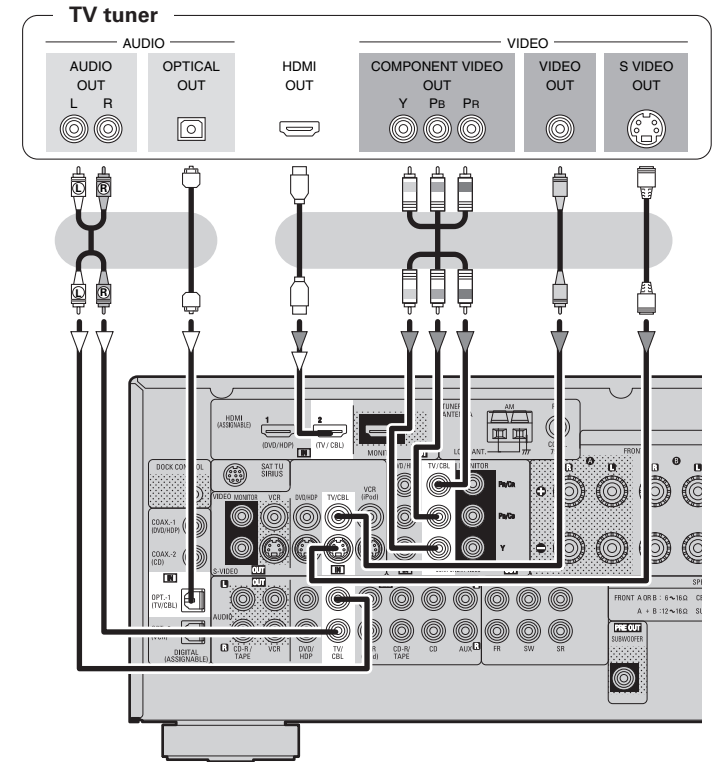

When using a coaxial cable for the digital audio connection, make the settings at "System Setup" – "Input Setup" – "Digital In Assign" (page 24).

#### NOTE

Because video signals are output from the AVR-589's monitor output terminal in the same format as the video input signals, **the monitor output terminal should be of the same type as the terminal used for input.**

## Connecting the Recording Components

Carefully check the left (L) and right (R) channels and the inputs and outputs, and be sure to interconnect correctly.

### Video Cassette Recorder

Select the terminal to use and connect the device.

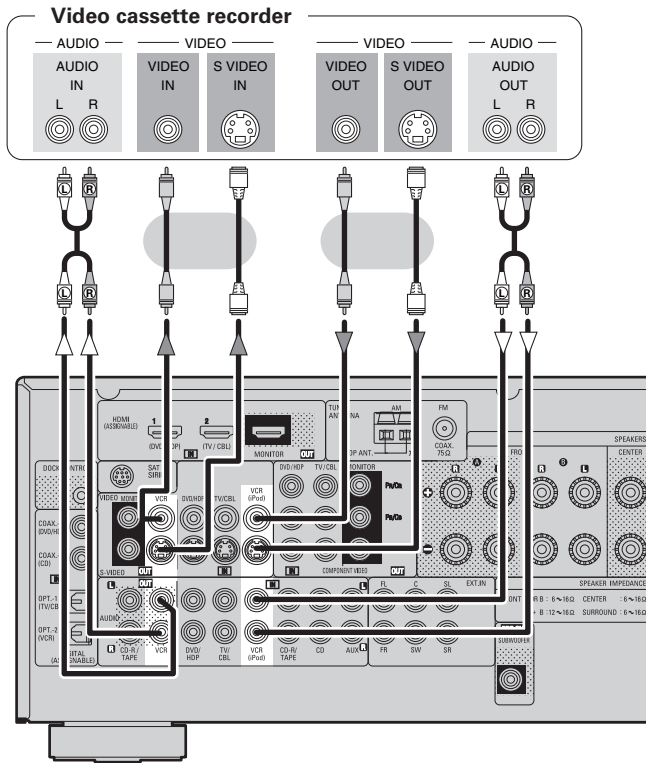

### CD Recorder / MD Recorder / Tape Deck

Select the terminal to use and connect the device.

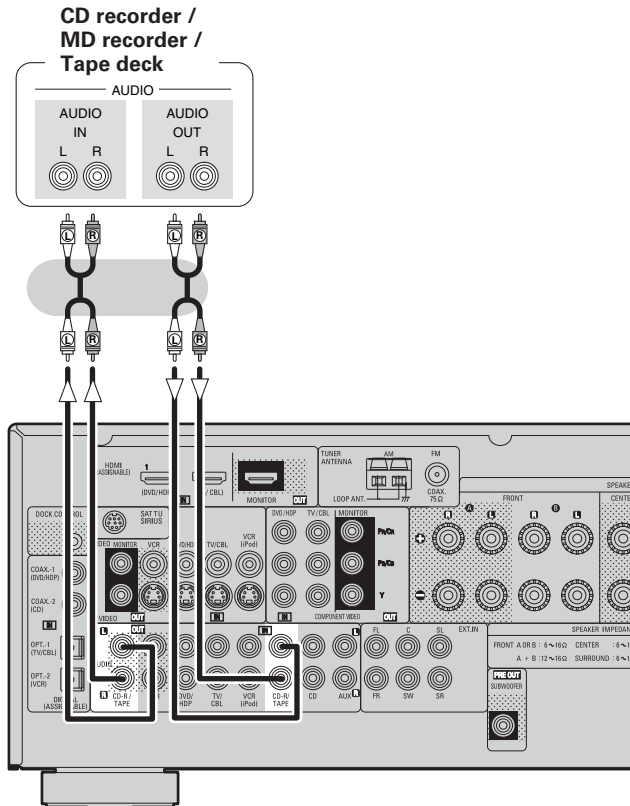

## Connections to Other Devices

Carefully check the left (L) and right (R) channels and the inputs and outputs, and be sure to interconnect correctly.

### Video Camera / Game Console

Select the terminal to use and connect the device.

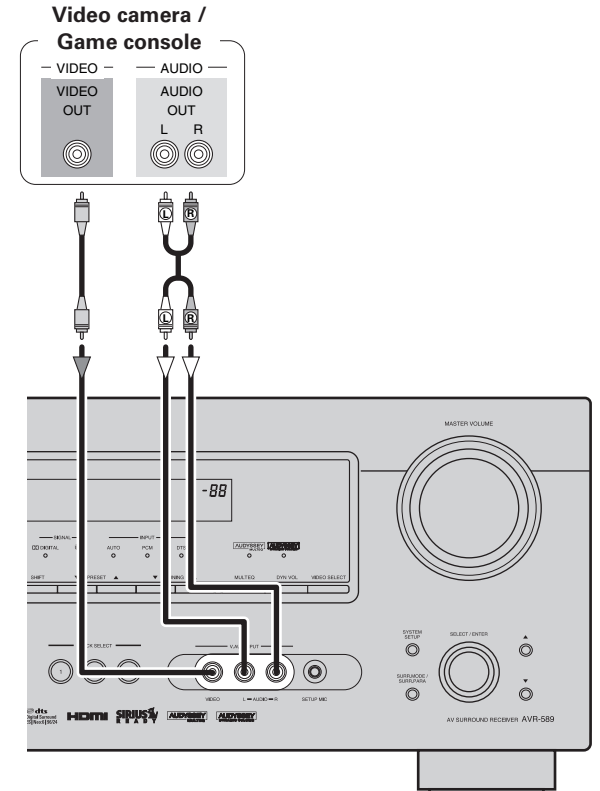

When recording via the AVR-589, the playback device's cable must be of the same type as the cable used to connect the AVR-589's VCR OUT connector.

**Example:** TV IN → S-Video cable : VCR OUT → S-Video cable  
TV IN → Video cable : VCR OUT → Video cable

## Component with Multi-channel Output connectors

Select the terminal to use and connect the device.

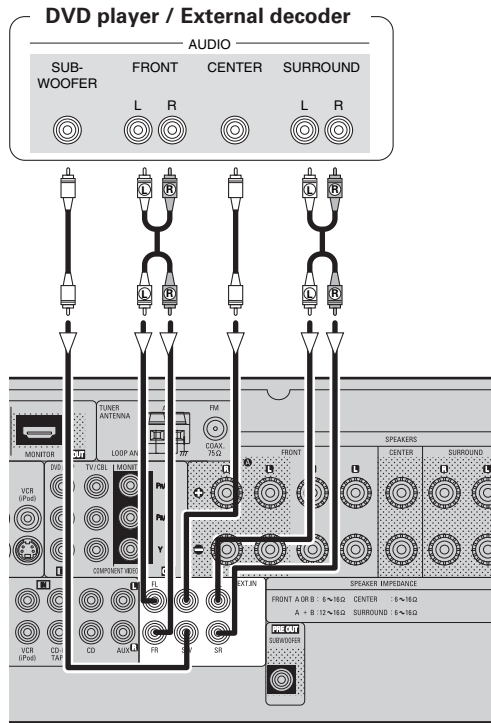

- To play the analog input signals input to the EXT. IN connectors, press the **INPUT MODE** button on the main unit or the **INPUT** button on the remote control unit and select "EXT. IN" (page 34).
- The video signal can be connected in the same way as a DVD player (page 11).
- To play copyright-protected discs, connect the AVR-589's EXT. IN connector with the DVD player's analog multi-channel output connector.

## SIRIUS connector

- The AVR-589 is a SIRIUS Satellite Radio Ready® receiver. You can receive SIRIUS® Satellite Radio by connecting to the SiriusConnect Home Tuner and subscribing to the SIRIUS service.
  - Plug the SIRIUS connector on the rear panel.
  - Position the Home Tuner antenna near a south-facing window to receive the best signal.
- For details, see "Listening to SIRIUS Satellite Radio Programs" (page 37).  
When making connections, also refer to the operating instructions of the SiriusConnect Home Tuner.

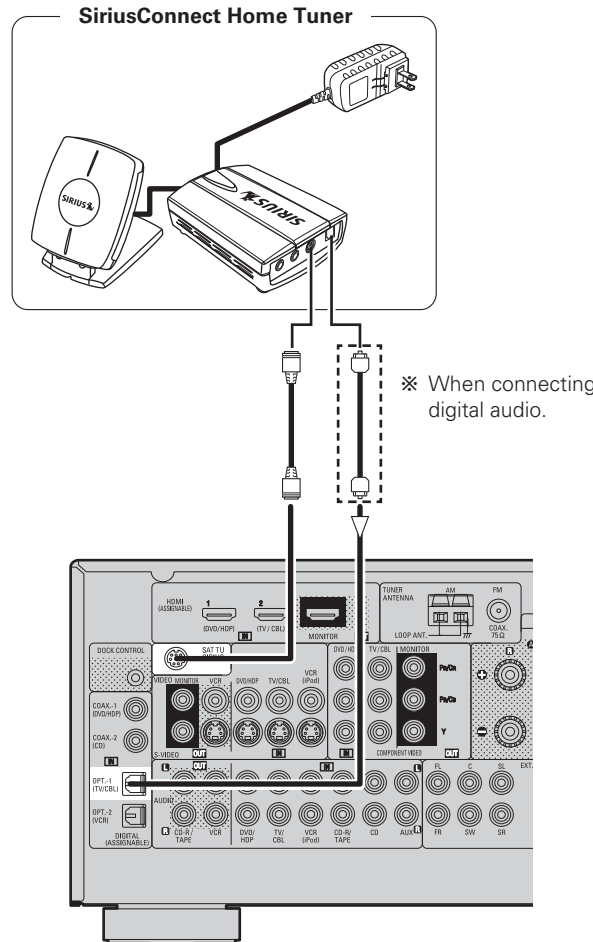

When connecting the Optical terminal, set the input Optical terminal allocations for "System Setup" – "Input Setup" – "Digital In Assign", in "SIRIUS".

### NOTE

Keep the power cord unplugged until the SiriusConnect Home Tuner connection have been completed.

©2006 SIRIUS Satellite Radio Inc. "SIRIUS", the SIRIUS dog logo, and channel names and logos are trademarks of SIRIUS Satellite Radio Inc.

### Positioning the Antenna

For a consistent satellite signal, the antenna must be positioned correctly. Use the following map to determine which area you are in and position the antenna accordingly.

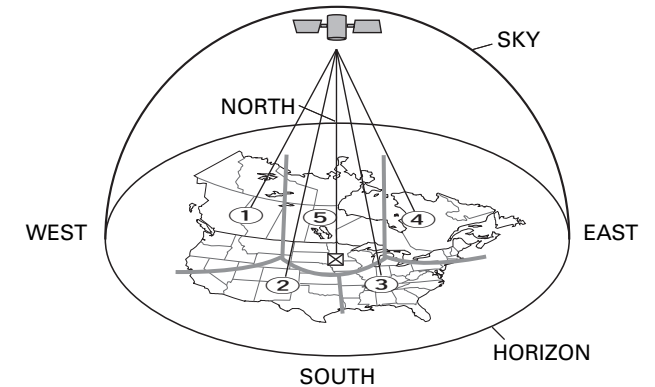

- Area 1 :** Point the antenna toward the sky in the **east, northeast, or southeast**, either through a window or outside.
- Area 2 :** Point the antenna toward the sky in the **north or northeast**, either through a window or outside.
- Area 3 :** Point the antenna toward the sky in the **north or northwest**, either through a window or outside.
- Area 4 :** Point the antenna toward the sky in the **west, northwest, or southwest**, either through a window or outside.
- Area 5 :** Put the antenna outside and point it **straight up**. The antenna cannot be used indoors.

## Antenna terminals

An F-type FM antenna cable plug can be connected directly.

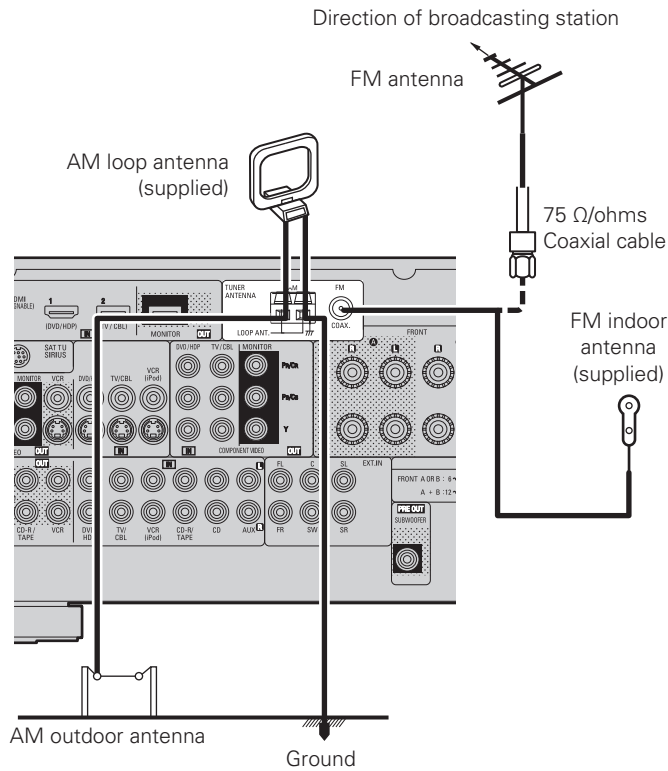

### AM loop antenna assembly

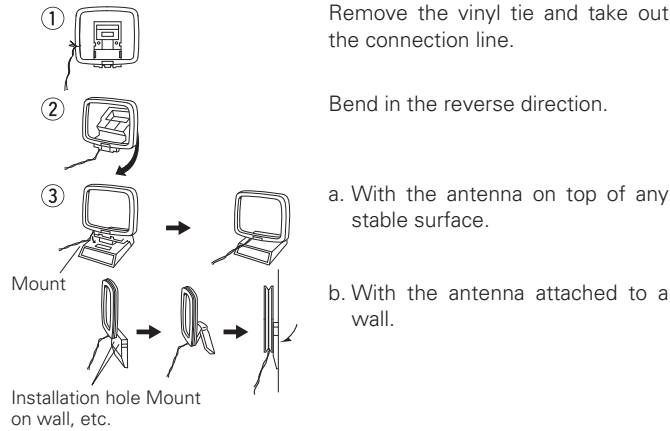

### Connection of AM antennas

1. Push the lever.
2. Insert the conductor.
3. Return the lever.



### Note to CATV system installer:

This reminder is provided to call the CATV system installer's attention to Article 820-40 of the NEC which provides guidelines for proper grounding and, in particular, specifies that the cable ground shall be connected to the grounding system of the building, as close to the point of cable entry as practical.

## Connecting the Power Cord

Wait until all connections have been completed before connecting the power cord.

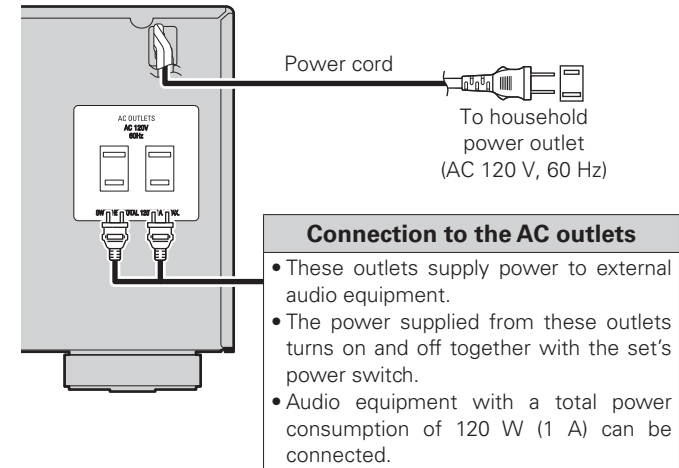

### NOTE

- Insert the AC plugs securely. Incomplete connections could cause noise.
- Only use the AC outlets to plug in audio equipment. Do not use them as power supplies for hairdryers or anything other than audio equipment.

## Once Connections are Completed

### Turning the Power On (page 34)

# Operations

## Menu Map

### Auto Setup (page 17 ~ 19)

※ When the setup microphone is connected.

- Start Menu
  - Step 1: Speaker Detection
  - Step 2: Measurement
  - Step 3: Calculation
  - Step 4: Check
  - Step 5: Store

### System Setup (page 20 ~ 26)

- |  |   |  |
|--|---|--|
| <ul style="list-style-type: none"> <li>□ Speaker Setup (page 21 ~ 23)                             <ul style="list-style-type: none"> <li>• Speaker Configuration</li> <li>• Subwoofer Mode Setup</li> <li>• Distance</li> <li>• Crossover Frequency</li> <li>• Test Tone</li> <li>• Restore</li> </ul> </li> </ul> | <ul style="list-style-type: none"> <li>□ Input Setup (page 23 ~ 25)                             <ul style="list-style-type: none"> <li>• HDMI In Assign</li> <li>• Digital In Assign</li> <li>• iPod Assign</li> <li>• Audio Delay</li> <li>• EXT. IN Subwoofer Level</li> <li>• Auto Preset Memory</li> <li>• Parental Lock</li> <li>• Edit Lock Code</li> </ul> </li> </ul> | <ul style="list-style-type: none"> <li>□ Option Setup (page 26)                             <ul style="list-style-type: none"> <li>• Volume Control                                     <ul style="list-style-type: none"> <li>· Volume Limit</li> <li>· Power On Level</li> <li>· Mute Level</li> </ul> </li> <li>• Auto Surround Mode</li> <li>• Direct Mode Setup</li> <li>• Remote ID Setup</li> </ul> </li> </ul> |
|--|---|--|

### Parameter (page 29 ~ 33)

- |  |  |   |
|--|--|---|
| <ul style="list-style-type: none"> <li>□ Surround Parameter                             <ul style="list-style-type: none"> <li>• Mode</li> <li>• Cinema EQ</li> <li>• D. Comp</li> <li>• LFE</li> <li>• Center Image</li> <li>• Panorama</li> <li>• Dimension</li> <li>• Center Width</li> </ul> </li> </ul> | <ul style="list-style-type: none"> <li>• Delay Time</li> <li>• Effect Level</li> <li>• Room Size</li> <li>• SW ATT</li> <li>• Subwoofer</li> <li>• Tone Control</li> <li>• Bass</li> <li>• Treble</li> </ul> | <ul style="list-style-type: none"> <li>• MultEQ</li> <li>• Dynamic EQ</li> <li>• Dynamic Volume</li> <li>• DV Setting</li> <li>• RESTORER</li> <li>• Night Mode</li> <li>• Default</li> </ul> |
|--|--|---|

### Information (page 33)

- Status
- Audio Input Signal

## Examples of Front Display

Some typical examples are described below.

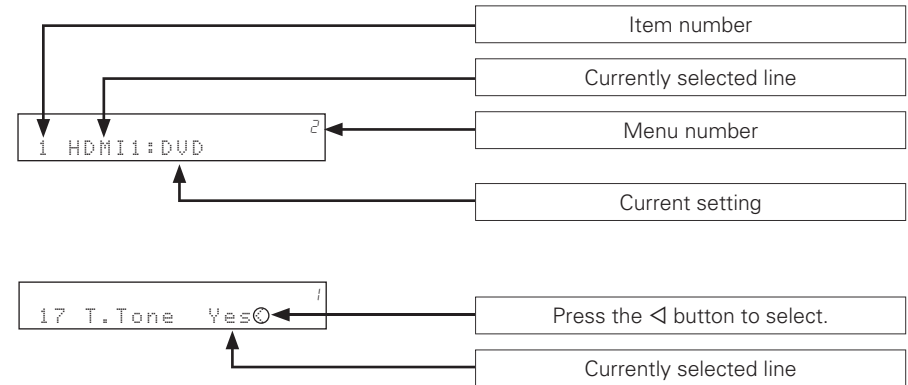

# Auto Setup

**Symbols used to indicate buttons in this manual**

- Button located on both the main unit and the remote control unit → **BUTTON**
- Button only on the main unit → **<BUTTON>**
- Button only on the remote control unit → **[BUTTON]**

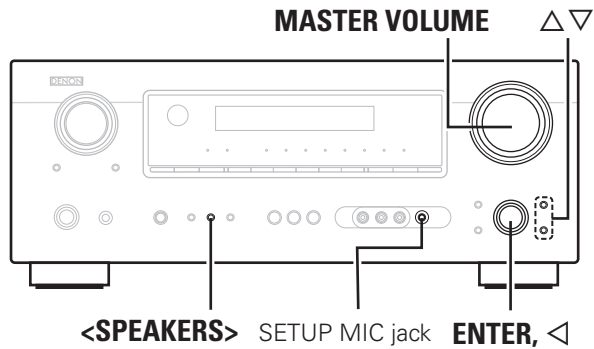

[Front]

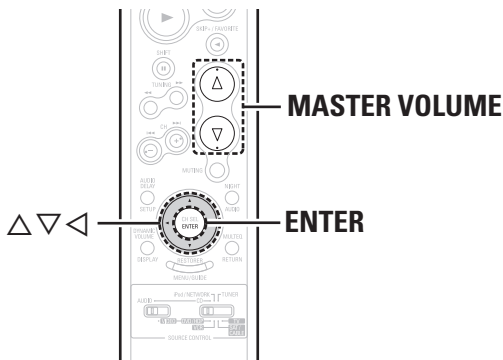

[Rear]

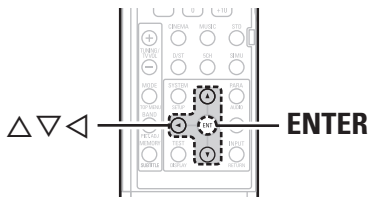

- Audyssey MultEQ automatically measures the acoustical problems in the listening environment to create the best audio experience for your home theater.
- Audyssey MultEQ optimizes a large listening area where one or more listeners are seated. Measurements are performed by placing the calibrated microphone (DM-A409) successively at multiple positions throughout the listening area as shown in **Example ①**. For best results, it is strongly recommended to measure 6 positions so that the measurements have the proper spatial weighting. Even if the listening environment is small as shown in **Example ②**, measuring at multiple points throughout the listening environment results in more effective correction.

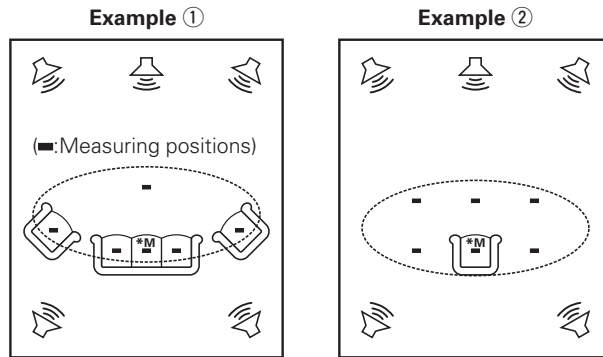

**About the main listening position (\*M)**

The main listening position refers to the most central position where one would normally sit within the listening environment. MultEQ uses the measurements from this position to calculate speaker distance, level, polarity, and the optimum crossover value for the subwoofer.

To make manual adjustments to the settings, see pages 21 ~ 23 .

## Preparations

**1** Press **<SPEAKERS>** to select the front speakers **Front A, Front B or Front A+B**.

**2** Connect the included calibrated setup microphone to the **SETUP MIC jack on the main unit**.  
"Auto Set<Start>" is displayed.

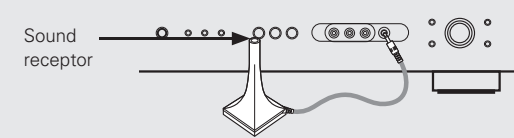

**3** Place the microphone at ear height on a tripod or stand with the microphone pointing directly up towards the ceiling.

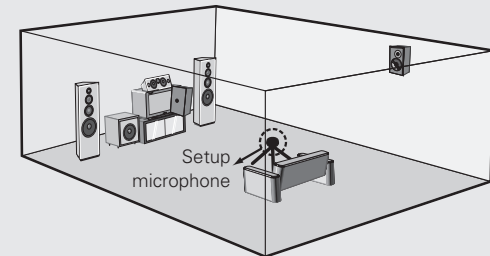

※ Do not hold the microphone in your hand during measurements. Be sure that the path from microphone to the speakers is not blocked by objects. Avoid placing the microphone close to a seat back or wall as sound reflections may give inaccurate results.

When using a subwoofer, make the following settings before starting the auto setup procedure:

- Defeat the volume and crossover controls if possible
- If this is not possible then set
  - Volume: "12 o'clock" position
  - Crossover frequency: "Maximum/Highest Frequency"
  - Low pass filter: "Off"
  - Standby mode: "Off"

**NOTE**

- Do not disconnect the setup microphone until the auto setup procedure is completed.
- When using headphones, unplug the headphones before starting the auto setup procedure.

## Auto Setup

Optimize settings for speakers in use.

### 1 Auto Setup

The settings found at this stage are applied automatically.

[Auto setup flow]

**Step 1: Speaker Detection**



**Step 2: Measurement**



**Step 3: Calculation**



**Step 4: Check**



**Step 5: Store**

**NOTE**

- Loud test sounds may be played during Audyssey MultEQ automatic speaker setup. This is part of normal operation. If there is background noise in room, these test signals will increase in volume.
- Do not stand between the speakers and setup microphone or allow obstacles in the path while the measurements are being made. This will cause inaccurate readings.
- Make the room as quiet as possible. Background noise can disrupt the room measurements. Close windows, silence cell phones, televisions, radios, air conditioners, fluorescent lights, home appliances, light dimmers, or other devices as measurements may be affected by these sounds. Cell phones should be placed away from all audio electronics during the measurement process as Radio Frequency Interference (RFI) may cause measurement disruptions (even if the cell phone is not in use).
- Operating **MASTER VOLUME** during the measurements will cancel the measurements.

## About the Auto Setup

The Audyssey MultEQ auto setup function detects the presence of each speaker and automatically calculates the speaker size, channel level, distance, and optimal crossover frequency setting. Audyssey MultEQ corrects acoustical distortions within the listening area. Before starting, connect and position all of your speakers. Once started, MultEQ will play a series of test tones through each speaker.



If an error message appears during the measurements, check "Error Messages", take the advised action, then start the measurements again (page 19).

### Step 1 : Speaker Detection

The speaker connection and polarity are detected at the first measurement position (main listening position). The following attributes are also determined at this time: "Speaker Size", "Speaker Distance", "Channel Level", "Crossover Frequency".

- ① Press  $\triangleleft$  while "Auto Set<Start" is displayed.
  - While the measurements are being conducted "Measure:FL <Ccl" ("FL" indicates the speaker being measured) is displayed.
  - When the measurements are completed, speaker detection check is displayed.

**Example :** For a 5.1 channel speaker configuration

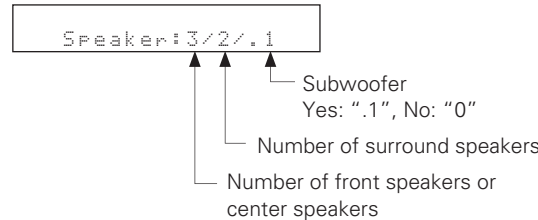

- To cancel the measurements, press  $\triangleleft$  while "Measure:FL <Ccl" is displayed ("Ccl" stands for "Cancel").



- If the result differs from the actual connection status or an error message appears, use  $\nabla$  to display "Retry<" and then press  $\triangleleft$  to repeat the measurement.
- If the result still differs from the actual connection status after re-measurement or the error message still appears, it is possible that the speakers are not connected properly. Turn the AVR-589 off, check the speaker connections and repeat the measurement process from the beginning.

**NOTE**

Do not change the speaker connections or subwoofer volume after "Step 1".

### Step 2 : Measurement

- ① Press  $\nabla$  to select "2nd Start<", then press  $\triangleleft$ .
  - The measurement of the 2nd position starts.
- ② Move the microphone to the 3rd position and press  $\triangleleft$ .
  - The measurement of the 3rd position starts.
- ③ Perform ② repeatedly.
  - "Calculate<" is displayed when you have completed measurements in 6 positions.
  - If you want to stop after measuring just five or fewer positions, use  $\nabla$  to display "Calculate<".



After completing a measurement position, move the microphone to the next position. Measure at 6 positions: the main listening position and 5 other surrounding positions. Although it is allowable to measure less than 6 positions, it is recommended to measure **6** for best results.

### Step 3 : Calculation

The values obtained from the measurements are automatically analyzed and the attributes for each of the speakers in the listening area are determined.

- ① Press  $\triangleleft$  while "Calculate" is displayed.
  - "Calculating" is displayed and analysis begins.



- Analysis takes several minutes to complete.
- The time required for this analysis depends on the number of speakers connected. The greater the number of speakers connected, the longer analysis will take.

**NOTE**

Do not change the speaker connections or subwoofer volume, or speaker locations after making measurements. If changes are necessary, make the changes and use the Audyssey MultEQ auto setup once again for an updated EQ solution.

### Step 4 : Check

When analysis is complete, "Parameter Check<" is displayed. Press ◀ and check the analysis results for the following four items.

- ① Make your selection using Δ ▽ and press ◀.
  - Presence and size of speaker  
"SpConfig. Check<"
  - Distance of speaker from listening position  
"Distance Check<"
  - Speaker channel level  
"Ch Level Check<"
  - Crossover Frequency  
"Crossover Check<"
- ② Use Δ or ▽ to change which speaker is displayed.

**To switch to another analysis result item**

Press **ENTER**.  
This returns you to analysis results items, so repeat operation ①.

**To proceed to "Step 5 : Store"**

During display of crossover frequency result or analysis results item, press **ENTER**.  
• "Store<" is displayed.



- To proceed to "Step 5" without checking the analysis result, use Δ ▽ to select "Store<" while "Parameter Check<" is displayed.
- Values that are different from the actual distance may be set for speakers with built-in filters (subwoofers, etc). This is because filters add electrical delay to the signal that should be compensated.

### Step 5 : Store

The auto setup measurement results are stored in the AVR-589.

- ① Press ◀ while "Store<" is displayed.
  - "Storing" blinks on the display panel while the results are being stored.
  - When storing is complete, "Completed" is displayed followed by "Disconnect Mic".
- ② Disconnect the setup microphone from the AVR-589.

**To cancel storing**

Use Δ or ▽ to display "Cancel<" while "Store<" is displayed and press ◀.  
• All the measured auto setup data will be erased.

**NOTE**

Do not turn the power off while the settings are being stored.

## 2 Error Messages

If the auto setup procedure could not be completed due to speaker installation, the measuring environment, etc. an error message is displayed. Check the relevant items and be sure to take the necessary measures. After addressing any issues, perform the auto setup procedure over again.

Error messages (examples)	Cause	Measures
Mic or Sp:None	<ul style="list-style-type: none"> <li>• The included setup microphone is not connected.</li> <li>• Not all speakers could be detected.</li> </ul>	<ul style="list-style-type: none"> <li>• Connect the included setup microphone to the SETUP MIC jack on the main unit.</li> <li>• Check the speaker connections.</li> </ul>
Ambient Noise	<ul style="list-style-type: none"> <li>• Too much noise in the room for accurate measurements to be made.</li> <li>• Speaker or subwoofer sound is too low for accurate measurements to be made.</li> </ul>	<ul style="list-style-type: none"> <li>• Either turn off any device generating noise or move it away.</li> <li>• Try again when the surroundings are quieter.</li> <li>• Check the speaker installation and the direction in which the speakers are facing.</li> <li>• Adjust the subwoofer's volume.</li> </ul>
Caution:Sp None ↕ The messages alternate FR	<ul style="list-style-type: none"> <li>• Displayed speaker could not be detected.                             <ul style="list-style-type: none"> <li>· The front L and front R speakers were not properly detected.</li> <li>· Only one channel of the surround speakers was detected.</li> </ul> </li> </ul>	<ul style="list-style-type: none"> <li>• Check the connections of the displayed speaker.</li> </ul>
Caution:Phase ↕ The messages alternate SL	<ul style="list-style-type: none"> <li>• Displayed speaker connected with the polarities reversed.</li> </ul>	<ul style="list-style-type: none"> <li>• Check the polarities of the displayed speaker.</li> <li>• For some speakers, this error message may be displayed even if the speaker is properly connected. If the connection is correct, use the Δ or ▽ buttons to display "Skip&lt;" and then press ◀.</li> </ul>



Select "Retry" to make the measurements again.

**NOTE**

Be sure to turn the power off before checking speaker connections.

# System Setup

**Symbols used to indicate buttons in this manual**

- Button located on both the main unit and the remote control unit → **BUTTON**
- Button only on the main unit → **<BUTTON>**
- Button only on the remote control unit → **[BUTTON]**

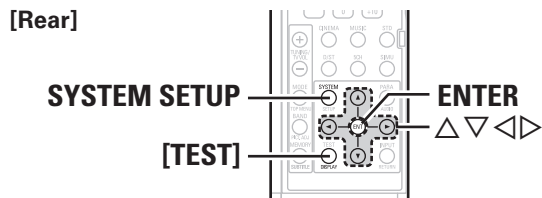
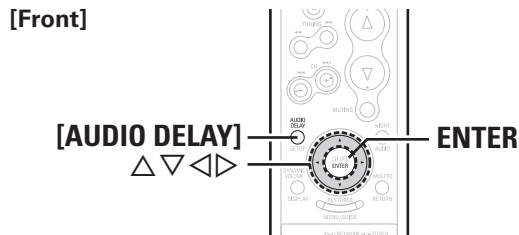
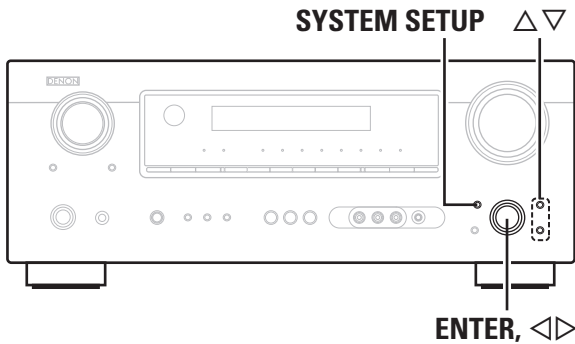

Make detail settings for various parameters.

## System Setup Operation

The same operation is possible on the main unit or remote control unit.

- 1 Press SYSTEM SETUP.**  
"System Setup" is displayed.
- 2 Press ENTER.**  
Three setup menu categories are displayed.  
"1. Sp" : Speaker Setup  
"2. In" : Input Setup  
"3. Op" : Option Setup
  - The cursor of the item number selected blinks.
  - For details of the items to be set in each item, see "Menu Map" (page 16).
- 3 Press <> to select the item you want to set, then press ENTER.**  
The detailed setup menu for each item is displayed.
- 4 Press Δ ∇ to select the item you want to change, then press <> to change the setting.**
- 5 Press ENTER or ∇ to confirm the next settings.**

- To move to a setup item of another category**  
Press **SYSTEM SETUP**.
  - Returns to the setup menu.
  - Perform steps 3 and 4.
- To exit setup**  
Press **SYSTEM SETUP** while the setup menu is displayed.
  - The display returns to normal.

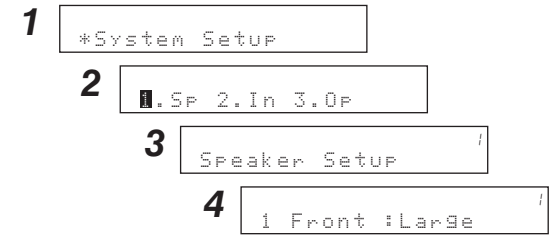

## Example of Display of Default Values

In lists of selectable items or adjustable ranges, the item surrounded by a border is the default value.



# 1. Speaker Setup

Use this procedure to set the speakers manually or if you wish to change the settings made with the auto setup procedure.

- 1 ~ 4 **Speaker Configuration**
- 5 **Subwoofer Mode Setup**
- 6 ~ 11 **Distance**
- 12 ~ 16 **Crossover Frequency**
- 17 **Test Tone**
- 18 **Restore**

## 1 ~ 4 Speaker Configuration

Select speaker configuration and size.  
(bass reproduction capability)

### [Display]

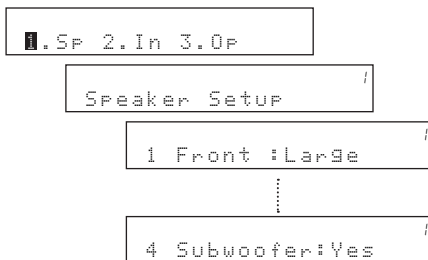

## 1 Front Speaker

Select front speaker size.

[Selectable items] **Large** **Small**

## 2 Center Speaker

Select center speaker use and size.

[Selectable items] **Large** **Small** **None**

## 3 Surround Speaker

Select surround speakers use and size.

[Selectable items] **Large** **Small** **None**

## 4 Subwoofer

Select subwoofer use.

[Selectable items] **Yes** **No**

**Large** : Select this when using large speakers with ample low frequency reproduction capabilities.

**Small** : Select this when using small speakers without ample low frequency reproduction capabilities.

**None** : Select this when no speaker is connected.

**Yes** : Select this when a subwoofer is connected.

**No** : Select this when no subwoofer is connected.



- Select "Large" or "Small" not according to the physical size of the speaker but according to the low frequency reproduction capabilities based on the frequency set at "Crossover Frequency" (page 22).
- When "Front Speaker" is set to "Small", "Subwoofer" is automatically set to "Yes".
- If "Subwoofer" is set to "No", "Front Speaker" is automatically set to "Large".
- When "Front Speaker" is set to "Small", "Center Speaker" can not be set to "Large".

## 5 Subwoofer Mode Setup

Select low range signal to be reproduced by subwoofer.

### [Display]

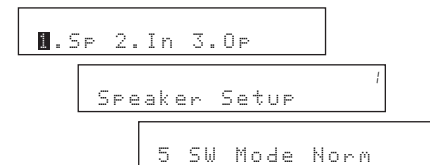

### [Selectable items]

**Norm** : Play low range and LFE signal of channels set to "Small".

**+Main** : Play low range and LFE signal of all channels.



- This can be set when "System Setup" – "Speaker Setup" – "Subwoofer" is set to "Yes".
- Play music or a movie source and select the mode offering the strongest bass.
- Select "+Main" if you want the bass signals to always be produced from the subwoofer.

**6 ~ 11 Distance**

Set distance from listening position to speakers. Before making the settings, measure the distance from the listening position to the different speakers.

**[Display]**

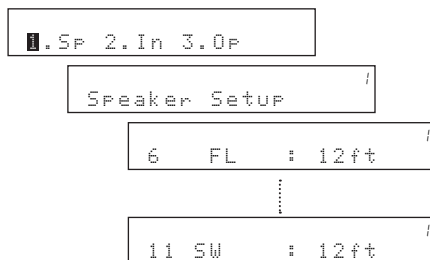

**Distance measurement**

Select the speaker you want to set, then set the distance. Set the value closest to the measured distance.

**[Variable range]**

**0ft ~ 60ft** : Settable in units of 1 foot.

Default setting :

- FL / FR / C / SW ..... 12 ft
- SL / SR ..... 10 ft

**NOTE**

Set the distance between the listening position and the various speakers to no more than 20 ft.

**12 ~ 16 Crossover Frequency**

Select crossover frequency from which subwoofer handles low range signal.

**[Display]**

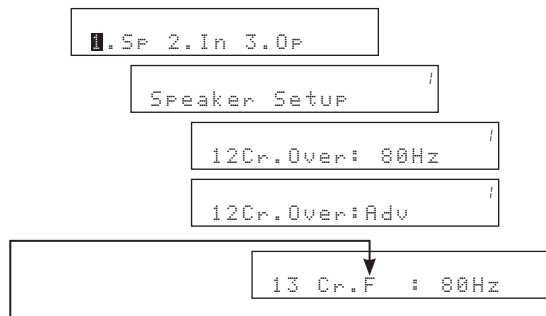

F : Front, C : Center, S : Surround, LFE : LFE are displayed.

Only the portion of the bass sound of the various speakers output from the subwoofer that has a frequency below the frequency set here is output.

Set this according to the low frequency reproduction capabilities of the speakers you are using.

**[Selectable items]**

- 40Hz 60Hz **80Hz** 90Hz 100Hz 110Hz 120Hz 150Hz
- 200Hz 250Hz :

Set the Crossover Frequency of all speakers as one.

**Advanced** :

Set the Crossover Frequency separately for the different speakers.

- ① When "Cr.Over:Adv" is displayed, press **ENTER** or  $\nabla$ .
- ② Press  $\triangleleft$   $\triangleright$  to set the crossover frequency of each speaker. The preset speaker changes each time you press  $\nabla$ .

**[Selectable items]**

- 40Hz 60Hz **80Hz** 90Hz 100Hz 110Hz 120Hz 150Hz
- 200Hz 250Hz

※ In the case of "LFE", there are 8 modes: 80Hz, 90Hz, 100Hz, 110Hz, 120Hz, 150Hz, 200Hz, 250Hz.



- If in the "Advanced" settings, "Subwoofer Mode Setup" (page 21) in the "System Setup" is set to "Norm", it is possible to make this setting for speakers set to "Small" at "Speaker Configuration". If set to "+Main", this setting can be made regardless of the speaker size.
- For speakers set to "Small", sound below the crossover frequency is cut from the sound output. The cut bass sound is output from the subwoofer or front speakers.
- Always set the crossover frequency to "80Hz". When using small speakers, however, we recommend setting the crossover frequency to a higher frequency.

**17 Test Tone**

Adjust channel levels to obtain equal volume from all speakers.

**[Display]**

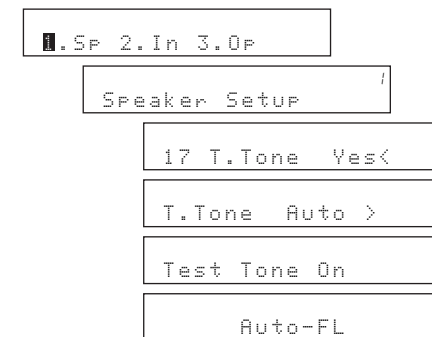

**Test Tone**

Select test tone playback method.

**[Selectable items]**

- Auto** : Automatically switch speaker from which test tone is output.
- Manual** : Manually switch speaker from which test tone is output.

### Test Tone Start

Press ◀ to select "Yes", then press ◀ ▶ to select "Auto" or "Manual".

Then press ▽. Out put the test tone.

**Auto** : Press ◀ ▶ to adjust the volume.

**Manual** : Press △ ▽ to select the speaker, then press ◀ ▶ to adjust the volume.

When the adjustments are completed, press **ENTER** to finish the test tone.

[Variable range] **-12dB** ~ **0dB** ~ **+12dB**

### Operating from the remote control unit

Adjusting with the remote control unit using the test tones is only possible in the "Auto" mode and only effective in the STANDARD mode. The adjusted levels for the different modes are automatically stored in the memory.

#### [Adjusting using test tones]

- ① Press **[TEST]**.  
Test tones are output from the various speakers.
- ② Use ◀ ▶ to adjust so that the volume is equal for all speakers.
- ③ When the adjustments are completed, press **[TEST]**.



- Speakers set to "None" in the Speaker Configuration settings are not displayed.
- When "Channel Level" is adjusted, the adjusted values are set for all the surround modes.

### 18 Restore

After the Auto Setup measurements, it is possible to return those settings to the Auto Setup measurement results after changing the speaker settings (speaker configuration, distance, channel level and crossover frequency) with "System Setup" – "Speaker Setup".

Press ◀ to start.

[Display]

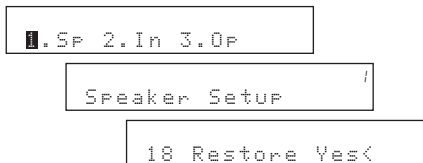

## 2. Input Setup

Use this procedure to select the input source and make the settings related to playing input sources.

- 1, 2 **HDMI In Assign**
- 3 ~ 6 **Digital In Assign**
- 7 **iPod Assign**
- 8 **Audio Delay**
- 9 **EXT. IN Subwoofer Level**
- 10 **Auto Preset Memory**
- 11 **Parental Lock**
- 12 **Edit Lock Code**

### 1, 2 HDMI In Assign

Select HDMI connector to assign to this source.

[Display]

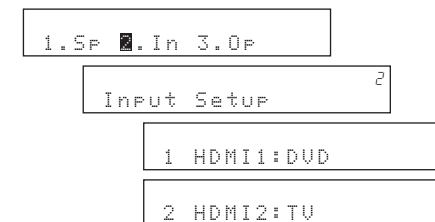

[Input terminals] **HDMI1** **HDMI2**

[Assignable input sources]

**DVD/HDP**\*1 **TV/CBL**\*2 **VCR** **V.AUX** **OFF**

\*1 : "DVD" is displayed.

\*2 : "TV" is displayed.

Input terminals	1 HDMI1	2 HDMI2
Default setting	DVD/HDP	TV/CBL



- With HDMI, the video and audio signals are transferred simultaneously. (The HDMI audio signal is output from the monitor.) At this time, set the input mode to "Auto".
- The audio signals input from the analog, digital and EXT. IN connectors are not output to the monitor.

### 3 ~ 6 Digital In Assign

Select digital input connector to assign to this source.

[Display]

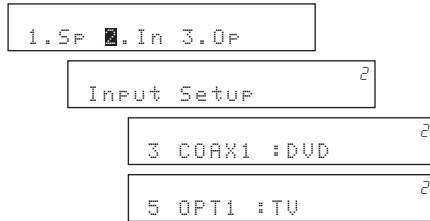

[Input terminals] **COAX1** **COAX2** **OPT1** **OPT2**

[Assignable input sources]



\*1 : "DVD" is displayed.  
\*2 : "TV" is displayed.

Input terminals	3 COAXIAL1	4 COAXIAL2	5 OPTICAL1	6 OPTICAL2
Default setting	DVD/HDP	CD	TV/CBL	VCR

### 7 iPod Assign

Assign control dock for iPod to this source.

[Display]



[Assignable input sources]



\*1 : "DVD" is displayed.  
\*2 : "TV" is displayed.



With the default settings, the control dock for iPod can be used connected to the VCR (iPod) connector.

### 8 Audio Delay

Compensate for mismatched timing between video and audio.

[Display]

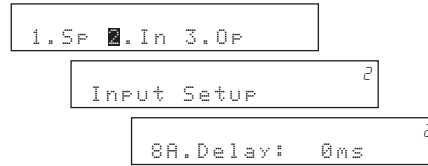

Delay audio.  
This sets the delay time for audio signals.

[Variable range] **0 ms** ~ **200 ms**

With a movie source, for example, adjust so that the movement of the actors' lips is synchronized with the sound.



**Operating from the remote control unit**

Press **[AUDIO DELAY]**.



- This cannot be adjusted when playing in the EXT. IN, DIRECT or STEREO mode (with "Front Speaker" set to "Large", "Tone Control" to "OFF" and "MultEQ" to "OFF").
- Store each input source.

### 9 EXT. IN Subwoofer Level

Set the subwoofer level for playback.  
Select according to the player in use.

[Display]

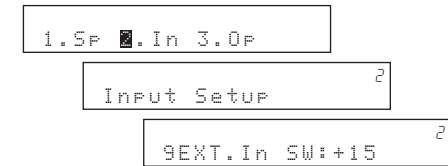

[Selectable items]

**0dB** **+5dB** **+10dB** :

Select according to the player in use.

**+15dB** :

This is the recommended level.

### 10 Auto Preset Memory

Use the auto preset function to program radio stations.

Press <1> to start.

- "CH" blinks on the display and searching begins.
- "Completed" appears once searching is completed.

[Display]

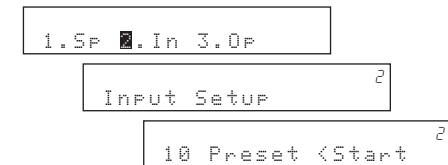

If an FM station cannot be preset automatically, select the desired station by tuning it in manually, then preset it manually.

**NOTE**

"Auto Preset Memory" is displayed when the input source is "FM" and "AM".

**11 Parental Lock**

For any channel, set the radio reception limits.

- ① Press  $\triangleleft$ .
- ② Using  $\triangle\triangledown\triangleleft\triangleright$ , input the password (4 digits number) and press **ENTER**.
- ③ Set the lock by pressing  $\triangleleft\triangleright$ .

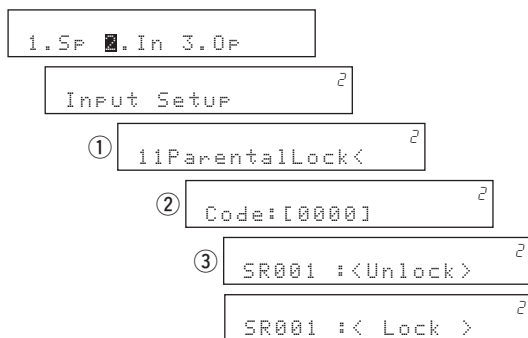
**[Display]****[Selectable items]**

**Unlock** : Do not lock selected channel(s).

**Lock** : Lock selected channel(s).

※ When a Parental Locked channel is tuned, "Code : [ ]" is displayed, then input the password.



- The default password is "0000". If you wish to change this password, set the new password with "Edit Lock Code".
- If the password is incorrectly input, "Incorrect Code" is displayed, and proceed again from step ①.
- If the password input is 3 digits or less, "Enter 4-digit" is displayed, and input again with a 4 digit password.
- While listening to the channel being played, you can also set parental lock (👉 page 38).

**NOTE**

"Parental Lock" is displayed when input source is "SIRIUS" , and connected to SIRIUS Tuner.

**12 Edit Lock Code**

Change the password (See "Parental Lock").

- ① Press  $\triangleleft$ .
- ② Input old password (4 digits) using  $\triangle\triangledown\triangleleft\triangleright$ , and press **ENTER**.
- ③ Input new password (4 digits) using  $\triangle\triangledown\triangleleft\triangleright$ , and press **ENTER**.  
Be sure to memorize the password you have entered.
- ④ Input new password (4 digits) again using  $\triangle\triangledown\triangleleft\triangleright$ , and press **ENTER**. If the correct password is input, "Complete" is displayed, and the new password is modified.

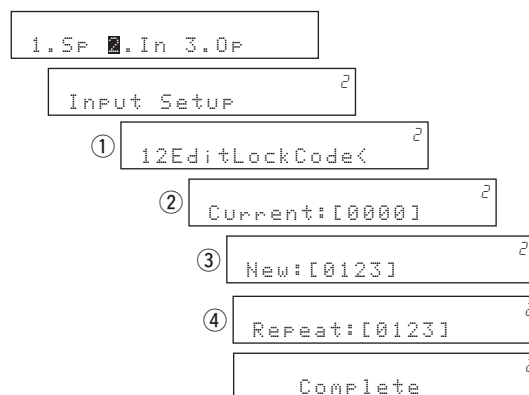
**[Display]**

- If the old password is incorrectly input, "Incorrect Code" is displayed, and proceed again from step ①.
- If the password input is 3 digits or less, "Enter 4-digit" is displayed, and input again with a 4 digit password.
- If the new password is not correctly input, "Disagreement" is displayed and the password does not change.

**NOTE**

"Edit Lock Code" is displayed when the input source is "SIRIUS".

### 3. Option Setup

Make various other settings.

- 1 ~ 3 Volume Control
- 4 Auto Surround Mode
- 5 Direct Mode Setup
- 6 Remote ID Setup

#### 1 ~ 3 Volume Control

Set the main zone volume setting.

##### [Display]

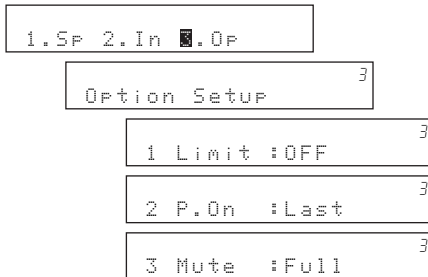

#### 1 Volume Limit

Make a setting for maximum volume.

##### [Selectable items]

- OFF** : Do not set a maximum volume.
- 20dB** : Set the maximum volume to -20 dB.
- 10dB** : Set the maximum volume to -10 dB.
- 0dB** : Set the maximum volume to 0 dB.

#### 2 Power On Level

This sets the volume set when the main zone's power is turned on.

##### [Selectable items]

- Last** : Use the memorized setting from the last session.
- : Always use the muting on condition when power is turned on.

##### [Variable range]

**-80dB ~ +18dB** : Set the volume level when the power is turned on in units of 1 dB.

※ The variable level when upper limit has been set with "Volume Limit" is "-80 dB ~ the set volume level".

#### 3 Mute Level

This sets the amount of attenuation of the volume when the mute mode is set in the main zone.

##### [Selectable items]

- Full** : The sound is cut off entirely.
- 40dB** : The sound is attenuated by 40 dB.
- 20dB** : The sound is attenuated by 20 dB.

#### 4 Auto Surround Mode

Make setting for memorizing surround mode setting for each input signal type.

##### [Display]



##### [Selectable items]

- ON** : Memorize settings. Most recently stored surround mode is automatically selected.
- OFF** : Do not memorize settings. Surround mode does not change according to input signal.



The auto surround mode function lets you store in the memory the surround mode last used for playing the three types of input signals listed below.

- ① Analog and PCM 2-channel signals (STEREO)
  - ② 2-channel signals of Dolby Digital, DTS or other multi-channel format (DOLBY PLII Cinema)
  - ③ Multi-channel signals of Dolby Digital, DTS or other multichannel format (DOLBY/DTS SURROUND)
- ※ Default settings are indicated in ( ).

#### 5 Direct Mode Setup

Select MultEQ use for DIRECT mode playback.

##### [Display]

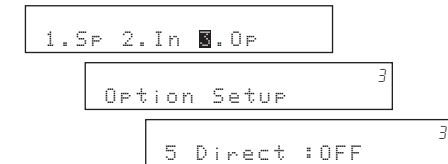

##### [Selectable items]

- ON** : Use MultEQ.
- OFF** : Do not use MultEQ.

#### 6 Remote ID Setup

Set remote control ID.

##### [Display]



##### [Selectable items]

- 1
- 2
- 3
- 4

##### NOTE

When using the AVR-589 with only the included remote control unit (RC-1104), there is no need to make settings. When using a separately sold remote control unit (RC-7000CI, etc.), this function can be used. Match the ID setting of the remote control unit and the receiver.

# Surround Modes

**Symbols used to indicate buttons in this manual**

- Button located on both the main unit and the remote control unit → **BUTTON**
- Button only on the main unit → **<BUTTON>**
- Button only on the remote control unit → **[BUTTON]**

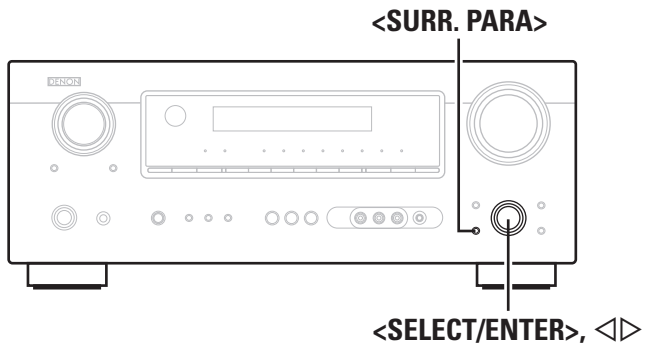

[Front]

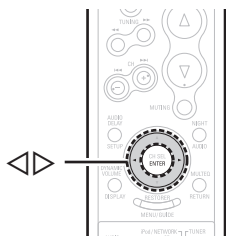

[Rear]

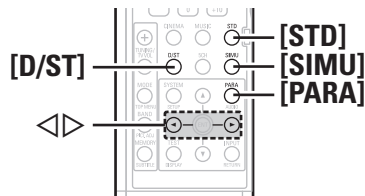

## 1 Standard Playback

This is the mode for enjoying surround sound according to the program source.

## Surround Playback of 2-channel Sources

### Selecting the surround mode

Select by turning **<SELECT/ENTER>** or pressing **[STD]**.

#### [Selectable items]

**DOLBY PLII** : The signals are decoded in DOLBY PLII for playback.

**DTS NEO:6** : The signals are decoded in DTS NEO:6 for playback.

### Select the mode to suit the source

Press **<Surr. Para>** or **[PARA]**. Display "Mode" and select your desired mode using **<Left>** **<Right>**.

#### DOLBY PLII

**Cinema** : This mode is suited for movie sources.

**Music** : This mode is suited for music sources.

**Game** : This mode is suited for games.

**PL** : This is the Pro Logic playback mode. This can be selected when playing with a DOLBY PLII decoder. When this mode is selected, "DOLBY PL" is displayed.

#### DTS NEO:6

**Cinema** : This mode is suited for movie sources.

**Music** : This mode is suited for music sources.



Select the "Cinema", "Music", "Game" and "PL" modes at "Surround Parameter" - "Mode" (page 30).

## Playing Multi-channel Sources (Dolby Digital, DTS, etc.)

In the case of standard playback of multi channel sources, the AVR-589 recognizes the format of the multi-channel audio input signal and automatically operates the appropriate decoder for surround sound.

### [Selectable items]

#### STANDARD :

Any of the surround modes in the "Display" column in the following table.

The mode changes depending upon factors such as the

- Input signal is being used.

Input signal		Display
Dolby Digital Source	DOLBY DIGITAL (other than 2ch)	DOLBY DIGITAL
DTS Surround Source	DTS (5.1ch) / DTS 96/24	DTS SURROUND
		DTS 96/24 (*)

\* : This is displayed when the input signal is "DTS 96/24".



- For details, see page 49.
- To select these surround modes using **<SELECT/ENTER>** or press **[STD]**.

## ② DSP Simulation Playback

The desired mode according to the program source and viewing situation can be selected from among 7 DENON original surround modes.

The surround parameters can be adjusted (🔧 page 47, 48) to achieve an even more realistic, powerful sound field.

### Selecting the surround mode

Select by turning <SELECT/ENTER> or pressing [SIMU].

#### [Selectable items]

**5CH STEREO** : This mode is for enjoying stereo sound from all speakers.

**ROCK ARENA** : This mode is for enjoying the atmosphere of a live concert in an arena.

**JAZZ CLUB** : This mode is for enjoying the atmosphere of a live concert in a jazz club.

**MONO MOVIE** \* : This mode is for playing monaural movie sources with surround sound.

**VIDEO GAME** : This mode is suited for achieving surround sound with video games.

**MATRIX** : This mode lets you add a sense of expansion to stereo music sources.

**VIRTUAL** : This mode is for enjoying surround effects using only the front speakers or headphones.

\*: When playing sources recorded in monaural in the MONO MOVIE mode, the sound will be off balance with a single channel (left or right), so input to both channels.



Depending on the program source being played, it may not be possible to achieve a satisfactory surround effect. In this case, try other modes to achieve a sound field suited to your tastes.

## ③ Direct Playback

### Selecting the mode

Select by turning <SELECT/ENTER> or pressing [D/ST].

#### [Selectable items]

**DIRECT** :

In this mode the signals bypass the tone adjustment circuitry for high quality sound.

The sound is output to the same channels as the input signal.

Input signal	Display
Analog signal / PCM (2ch) / Dolby Digital source / DTS source / Other 2-channel digital signals	DIRECT



For details, see page 49.

## ④ Stereo Playback

### Selecting the mode

Select by turning <SELECT/ENTER> or pressing [D/ST].

#### [Selectable items]

**STEREO** :

This is the mode for playing in stereo. The tone can be adjusted.

Sound is output from the front left and right speakers and subwoofer.

# Parameter

**Symbols used to indicate buttons in this manual**

- Button located on both the main unit and the remote control unit → **BUTTON**
- Button only on the main unit → **<BUTTON>**
- Button only on the remote control unit → **[BUTTON]**

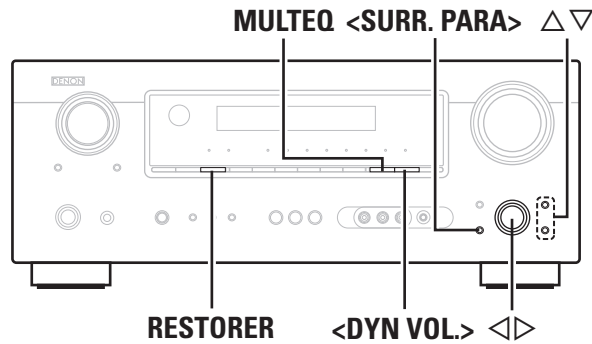

[Front]

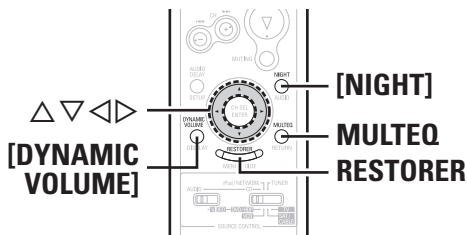

[Rear]

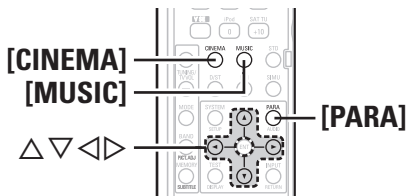

## Adjusting the Parameters

- 1** Press **<Surr. Para>** or **[PARA]**.  
Parameter is displayed.
- 2** Use **△▽** to select which parameters to adjust.  
Only those parameters which can be adjusted under the current playback status are displayed.
- 3** Use **◀▶** to adjust the parameters.  
Repeat steps 2 and 3 to set each parameter.

- ❑ To exit adjustment**
- Press **<Surr. Para>** or **[PARA]** during adjustment.
  - If no adjustment is made for a period of about 5 seconds, the adjustments made up that point are registered and the AVR-589 returns to the original mode.

## Surround Parameter

Adjust surround sound parameters.

The parameters (items) which can be adjusted differ depending upon the following conditions.

- Whether an input signal is present (when playing) or not (when stopped, etc.).
- The type of input signal
- The type of surround mode

For details of which parameters can be adjusted in each surround mode, see "Surround Modes and Parameters" (👉 page 47, 48).

- 1** Mode
- 2** Cinema EQ
- 3** D. Comp (Dynamic Range Compression)
- 4** LFE
- 5** Center Image
- 6** Panorama
- 7** Dimension
- 8** Center Width
- 9** Delay Time
- 10** Effect Level
- 11** Room Size
- 12** SW ATT (Subwoofer Attenuation)
- 13** Subwoofer
- 14** Tone Control
- 15** Bass
- 16** Treble
- 17** MultEQ
- 18** Dynamic EQ
- 19** Dynamic Volume
- 20** DV Setting (Dynamic Volume Setting)
- 21** RESTORER
- 22** Night Mode
- 23** Default

## 1 Mode

Select the mode to match the source (cinema source, music source, etc.).

### □ In the PLII mode

#### [Selectable items]

**Cinema** : This is the mode for cinema source.

**Music** : This is the mode for music source.

**Game** : This is the mode for game source.

**PL** : Dolby Pro Logic playback mode.  
(This is the mode for 4-channel playback (front L, front R, center, surround (MONO)).)

### □ In the DTS NEO:6 mode

#### [Selectable items]

**Cinema** : This is the mode for cinema source.

**Music** : This is the mode for music source.



### Operating from the remote control unit

You can operate "Cinema" mode or "Music" mode with the remote control unit.

Press **[CINEMA]** or **[MUSIC]**.



The "Music" mode is also effective for movie sources including a lot of stereo music.

## 2 Cinema EQ

Soften the treble range of movie soundtracks for better understanding.

#### [Selectable items]

**ON** : "Cinema EQ" is used.

**OFF** : "Cinema EQ" is not used.

## 3 D. Comp (Dynamic Range Compression)

Compress dynamic range (difference between loud and soft sounds).

#### [Selectable items]

**OFF** : Turn dynamic range compression off.

**Low** : Low setting.

**Mid** : Middle setting.

**High** : High setting.



When playing DTS sources, this is only displayed for compatible software.

## 4 LFE

Adjust the low-frequency effects level (LFE).

[Variable range] **-10dB** ~ **0dB**



For proper playback of the different program sources, we recommend setting to the values below.

- Dolby Digital sources: "0 dB"
- DTS movie sources: "0 dB"
- DTS music sources: "-10 dB"

## 5 Center Image

Assign center channel signal to front left and right channels for wider sound.

[Variable range] **0.0** ~ **0.3** ~ **1.0**

## 6 Panorama

Assign front L/R signal also to surround channels, for wider sound. If the surround effect seems weak, set "Panorama" to "ON".

[Selectable items] **ON** **OFF**

## 7 Dimension

Shift sound image center to front or rear, to adjust playback balance.

[Variable range] **0** ~ **3** ~ **6**

## 8 Center Width

Assign center channel signal to front left and right channels for wider sound.

[Variable range] **0** ~ **3** ~ **7**

## 9 Delay Time

Adjust delay time to control sound stage size.

[Variable range] **0 ms** ~ **30 ms** ~ **110 ms**

## 10 Effect Level

Adjust the strength of the surround effect.

[Variable range] **1** ~ **10** ~ **15**



Set to a lower level if the positioning and sense of phase of the surround signals seems unnatural.

## 11 Room Size

Determine size of acoustic environment.

#### [Selectable items]

**Small** : Simulate acoustics of a small room.

**Med-S** : Simulate acoustics of a medium-small room.

**Med** : Simulate acoustics of a medium room.

**Med-L** : Simulate acoustics of a medium-large room.

**Large** : Simulate acoustics of a large room.

#### NOTE

"Room Size" does not indicate the size of the room in which sources are played.

## 12 SW ATT (Subwoofer Attenuation)

Attenuate subwoofer level when using EXT. IN mode.

### [Selectable items]

**ON** : The input from the subwoofer channel is attenuated.

**OFF** : The input from the subwoofer channel is not attenuated. Usually use in this mode.



Set this to "ON" if the subwoofer channel level seems too high when playing audio signal.

## 13 Subwoofer

Turn subwoofer output on and off.

### [Selectable items]

**ON** : The subwoofer is used.

**OFF** : The subwoofer is not used.

## 14 Tone Control

Turn tone adjustments on and off.

### [Selectable items]

**ON** : Allow tone adjustment (treble, bass).

**OFF** : Playback without tone adjustment.



The tone cannot be adjusted when in the DIRECT mode.

### NOTE

When the "Dynamic EQ" setting is "ON", setting is not possible.

## 15 Bass

Adjust low frequency range (bass).

[Variable range] **-6dB** ~ **0dB** ~ **+6dB**

## 16 Treble

Adjust high frequency range (treble).

[Variable range] **-6dB** ~ **0dB** ~ **+6 dB**



"Bass" and "Treble" can be set when "Tone Control" is set to "ON".

## 17 MultEQ

Select the type of room correction desired from the following list:

### [Selectable items]

**Audyssey** : Optimize frequency response of all speakers.

**Byp. L/R** : Optimize frequency response of speakers except front L and R speakers.

**Flat** : Optimize frequency response of all speakers to flat response.

**OFF** : Turn equalizer off.

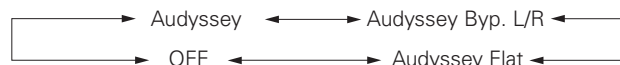

### Operating from the main unit or remote control unit

Press **MULTEQ**.

- When "Audyssey", "Audyssey Byp. L/R" or "Audyssey Flat" is selected, the Audyssey MultEQ indicator lights green.
- After running Auto Setup, if the Speaker Configuration, Distance, Channel Level and Crossover Frequency have changed without increasing the number of speakers measured, the Audyssey MultEQ indicator lights red.

### NOTE

- "MultEQ" can only be set when Auto Setup has been performed.
- "MultEQ" cannot be set in the following situations.
  - If "Auto Setup" fails to be completed.
  - After running Auto Setup, when the number of used speakers has increased from the number of measured speakers.



- If the settings of speakers for which "None" has been determined at "Auto Setup" are changed, "Audyssey", "Audyssey Byp. L/R" and "Audyssey Flat" cannot be selected. Either perform Auto Setup again, or return to the setting after running Auto Setup with "System Setup" - "Speaker Setup" - "Restore".
- When using headphones, "MultEQ" is set to "OFF".

## 18 Dynamic EQ

Audyssey Dynamic EQ solves the problem of deteriorating sound quality as volume is decreased by taking into account human perception and room acoustics. Audyssey Dynamic EQ works in tandem with Audyssey MultEQ to provide well-balanced sound for every listener at any volume level.

### NOTE

- "Dynamic EQ" can only be set when auto setup has been performed.
- "Dynamic EQ" cannot be set in the following situations.
  - If "Auto Setup" fails to be completed.
  - After running Auto Setup, when the number of used speakers has increased from the number of measured speakers.
- When "MultEQ" is set to "OFF", "Dynamic EQ" is automatically set to "OFF".
- "Night Mode" and "Tone Control" cannot be used jointly.

### [Selectable items]

**ON** : Use Dynamic EQ function.

**OFF** : Do not use Dynamic EQ function.



### Operating from the unit or remote control unit

Press **<DYN VOL>** or **[DYNAMIC VOLUME]**.



Before running Auto Setup and after running Auto Setup, if the number of speakers has increased or you pressed **<DYN VOL>** or **[DYNAMIC VOLUME]**, "Run Audyssey" is displayed. In this case, either perform Auto Setup again, or return to the setting after running Auto Setup with "System Setup" - "Speaker Setup" - "Restore".

### Operating conditions for each function

- **Dynamic EQ** : When "MultEQ" is set to "ON"
- **Dynamic Volume** : When "Dynamic EQ" is set to "ON"
- **DV setting** : When "Dynamic Volume" is set to "ON"

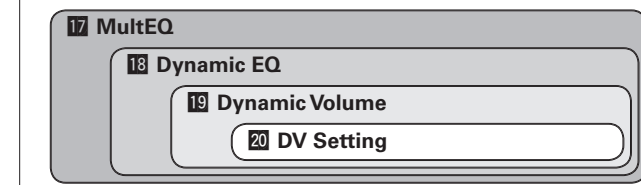

## 19 Dynamic Volume

Audyssey Dynamic Volume solves the problem of large variations in volume level between television programs, commercials, and between the soft and loud passages of movies.

Audyssey Dynamic EQ is integrated into Dynamic Volume so that as the playback volume is adjusted automatically, the perceived bass response, tonal balance, surround impression, and dialog clarity remain the same.

### NOTE

- “Dynamic Volume” can only be set when auto setup has been performed.
- “Dynamic Volume” cannot be set in the following situations.
  - If “Auto Setup” fails to be completed.
  - After running Auto Setup, when the number of used speakers has increased from the number of measured speakers.
- When “MultEQ” is set to “OFF”, “Dynamic Volume” is automatically set to “OFF”.
- “Night Mode” and “Tone Control” cannot be used jointly.

### [Selectable items]

**ON** : Use Dynamic Volume.  
The Dynamic Volume effect will be at the level of the “DV Setting”.

**OFF** : Do not use Dynamic Volume.

### Operating from the unit or remote control unit

Press **<DYN VOL>** or **[DYNAMIC VOLUME]**.

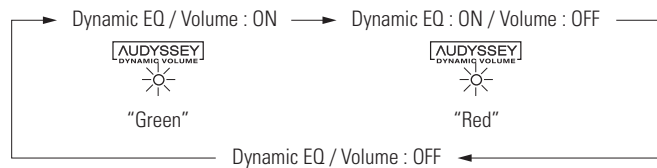

Before running Auto Setup and after running Auto Setup, if the number of speakers has increased or you pressed **<DYN VOL>** or **[DYNAMIC VOLUME]**, “Run Audyssey” is displayed. In this case, either perform Auto Setup again, or return to the setting after running Auto Setup with “System Setup” – “Speaker Setup” – “Restore”.

## 20 DV Setting (Dynamic Volume Setting)

Set Dynamic Volume effect.

### [Selectable items]

**Midnight** : High setting affects volume the most, causing all sounds to be of equal loudness.

**Evening** : Middle setting prevents loud and soft sounds from being much louder and softer respectively than average sounds.

**Day** : Low setting provides the least adjustments to the loudest and softest of sounds.

### NOTE

- “DV Setting” can only be set when auto setup has been performed.
- “DV Setting” cannot be set in the following situations.
  - If “Auto Setup” fails to be completed.
  - After running Auto Setup, when the number of used speakers has increased from the number of measured speakers.
  - If “Dynamic Volume” setting is “OFF”.

### About Dynamic EQ

Audyssey Dynamic EQ™ solves the problem of deteriorating sound quality as volume is decreased by taking into account human perception and room acoustics. Dynamic EQ selects the correct frequency response and surround levels moment-by-moment at any user-selected volume setting. The result is bass response, tonal balance, and surround impression that remain constant despite changes in volume. Dynamic EQ combines information from incoming source levels with actual output sound levels in the room, a prerequisite for delivering a loudness correction solution. Audyssey Dynamic EQ works in tandem with Audyssey MultEQ to provide well-balanced sound for every listener at any volume level.

### About Dynamic Volume

Audyssey Dynamic Volume™ solves the problem of large variations in volume level between television programs, commercials, and between the soft and loud passages of movies. Dynamic Volume looks at the preferred volume setting by the user and then monitors how the volume of program material is being perceived by listeners in real time to decide whether an adjustment is needed. Whenever necessary, Dynamic Volume makes the necessary rapid or gradual adjustments to maintain the desired playback volume level while optimizing the dynamic range. Audyssey Dynamic EQ is integrated into Dynamic Volume so that as the playback volume is adjusted automatically, the perceived bass response, tonal balance, surround impression, and dialog clarity remain the same whether watching movies, flipping between television channels, or changing from stereo to surround sound content.

## 21 RESTORER

This function restores compressed audio signals to how they were before compression and corrects the sense of volume of the bass and treble to obtain richer playback sound.

### [Selectable items]

**OFF** :

Do not use RESTORER.

**Mode1** (RESTORER 64):

Optimized mode for compressed sources with very weak highs.

**Mode2** (RESTORER 96):

Apply suitable bass and treble boost for all compressed sources.

**Mode3** (RESTORER HQ):

Optimized mode for compressed sources with normal highs.

The default setting for “iPod” is “Mode3”. All others are set to “OFF”.

### Operating from the main unit or remote control unit

Press **RESTORER**.

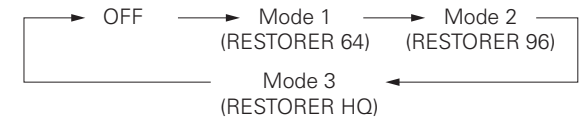

### About the RESTORER function

- Such compressed audio formats as MP3, WMA (Windows Media Audio) and MPEG-4 AAC reduce the amount of data by eliminating signal components that are hard for the human ear to hear. The RESTORER function generates the signals eliminated upon compression, restoring the sound to conditions near those of the original sound before compression. It also corrects the sense of volume of the bass to obtain richer sound with compressed audio signals.
- This is displayed on the “Surround Parameter” and can be set when the input source is selected to “SIRIUS” or analog signals (including AM/FM signals) or PCM signals (fs = 44.1/48 kHz) are input.

**22 Night Mode**

Optimized setting for late-night listening.  
Set the dynamic range compression of the output audio.

**[Selectable items]**

- OFF** : Turn night mode off.
- Low** : Low setting.
- Mid** : Middle setting.
- High** : High setting.

**Operating from the remote control unit**

Press **[NIGHT]**.

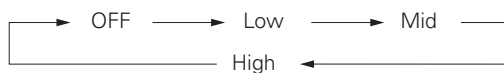
**NOTE**

When the "Dynamic EQ" setting is "ON", setting is not possible.  
When the "Dynamic Volume" setting is "ON", setting is not possible.

**23 Default**

Resets the settings to the default values.

**[Selectable items]**

- Yes** : Reset.
- No** : Do not reset.

**Information****Symbols used to indicate buttons in this manual**

- Button located on both the main unit and the remote control unit → **BUTTON**
- Button only on the main unit → **<BUTTON>**
- Button only on the remote control unit → **[BUTTON]**

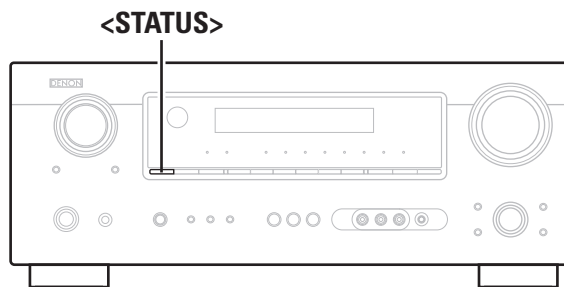

Information on the main unit's various settings (Status) and on input signals (Audio Input Signal) is shown on the display.  
The information displayed changes each time you press **<STATUS>**.  
The information is displayed for several seconds before the display returns to its original condition.

**[Items to be checked]**

- Surround Mode
  - Input signal
  - Dialogue normalization
  - Input function
  - Input digital terminal
  - Audio Delay
  - Tone Control
  - Channel level of each speaker
  - Cinema EQ
  - Night Mode
- etc.

**Dialogue normalization function**

This is automatically activated when playing Dolby Digital sources.  
This function automatically corrects the standard signal level for individual program sources.  
The correction value can be checked using **<STATUS>**.

OFFSET -4dB

The figure is the correction value when the standard level is corrected.



- The items displayed will differ depending upon the current settings, the presence or absence of an input signal or the type of input signal, etc.
- For details of the content of the items displayed, refer to the page containing an explanation of the settings.

# Playback

**Symbols used to indicate buttons in this manual**

- Button located on both the main unit and the remote control unit → **BUTTON**
- Button only on the main unit → **<BUTTON>**
- Button only on the remote control unit → **[BUTTON]**

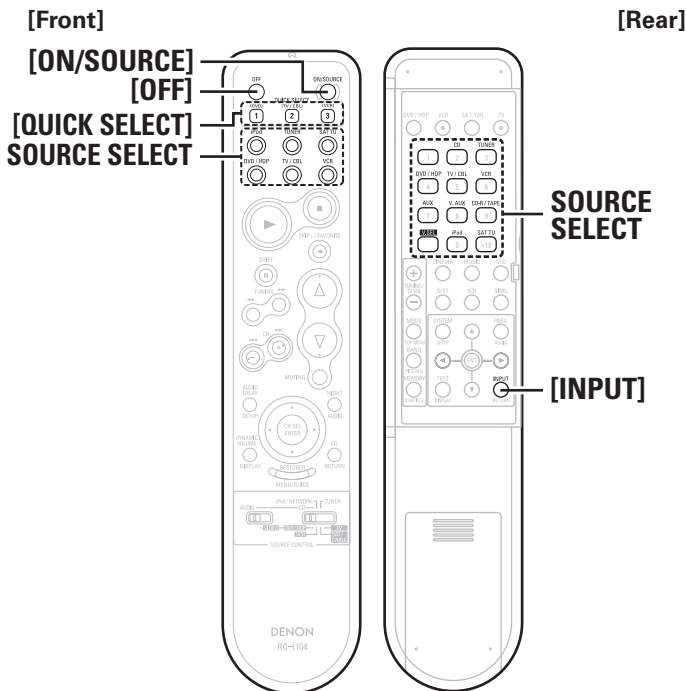
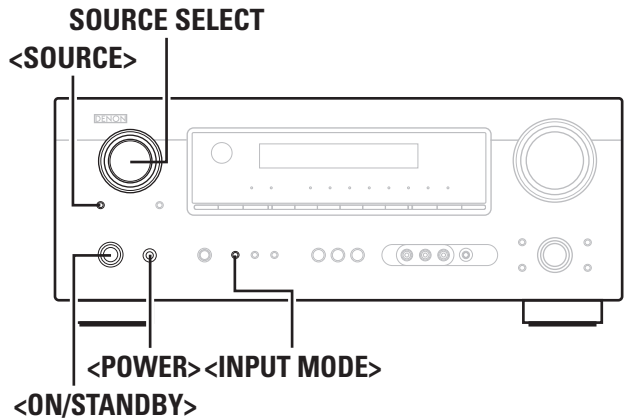

## Preparations

### Turning the Power On

- 1 Press <POWER>.**  
The power indicator lights red and the power is set to the standby mode.
- 2 Press <ON/STANDBY> or [ON/SOURCE].**  
The power indicator flashes green and the power turns on.  
  - ※ Also press **[SOURCE SELECT]** when in standby mode, the power turns on. In this case the input source is selected by remote control unit.
  - ※ Also press **[QUICK SELECT]** when in standby mode, the power turns on. In this case Quick Select is selected by remote control unit (page 41).

### Turning the Power Off

- 1 Press **<ON/STANDBY>** or **[OFF]**.  
The power is set to the standby mode.
- 2 Press **<POWER>**.  
The power indicator turns off, and so does the power.

**NOTE**

Power continues to be supplied to some of the circuitry even when the power is in the standby mode. When leaving home for long periods of time or when traveling, either press **<POWER>** to turn off the power, or unplug the power cord from the power outlet.

### Selecting the Input Source

Select the source using **SOURCE SELECT**. Turn **<SOURCE SELECT>** or press **[SOURCE SELECT]** to switch between input sources.

If "Rec Select" is selected for the input source, press **<SOURCE>** before turning **<SOURCE SELECT>**.

### Setting the Input Mode

Set the input mode for this source.

Press **<INPUT MODE>** or **[INPUT]**.

Each time you press the button, the input mode display will change.

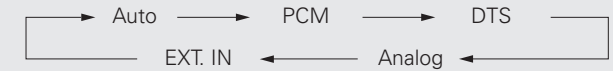

**[Selectable items]**

- Auto** : Detect type of digital input signal and decode and play automatically.
- PCM** : Decode and play only PCM input signals.
- DTS** : Decode and play only DTS input signals.
- Analog** : Play only signals from analog input.
- EXT. IN** : Play only signals from EXT. IN input.



- When a digital signal is properly input, the "DIGITAL" indicator lights on the display. If the "DIGITAL" indicator does not light, check the digital input connector assignment and the connections.
- The surround mode cannot be set if the input mode is set to "EXT. IN".
- Only set "PCM" and "DTS" when playing the respective signals.

**Symbols used to indicate buttons in this manual**

Button located on both the main unit and the remote control unit → **BUTTON**  
 Button only on the main unit → **<BUTTON>**  
 Button only on the remote control unit → **[BUTTON]**

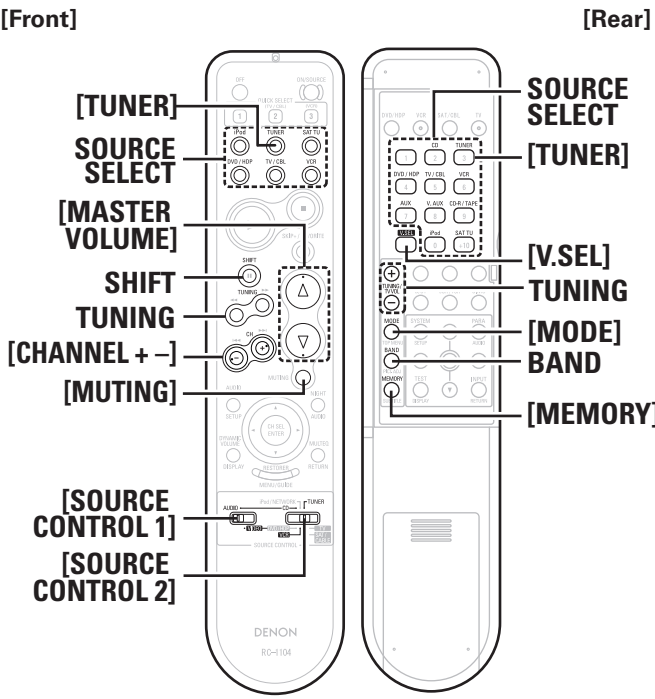
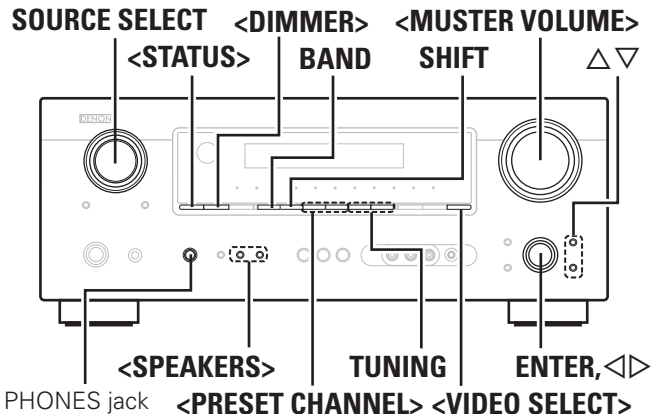

**Operations During Playback**

**Adjusting the Master Volume**

Either turn **<MASTER VOLUME>** or press **[MASTER VOLUME]**.

[Variable range] --- **-80.0dB ~ +18.0dB**

**NOTE**  
The adjustable range will differ depending upon factors such as the type of input signal and the channel level setting.

**Turning Off the Sound Temporarily (Muting)**

Press **[MUTING]**.

To cancel, press **[MUTING]** again. Muting can also be canceled by adjusting the master volume.

**Listening with Headphones**

Plug the headphones into the PHONES jack on the main unit.

The sound from the speakers and pre-out connectors is automatically cut.

**NOTE**  
Be careful not to set the volume too high when using headphones.

**Switching the front speakers**

Press **<SPEAKERS>**.

**Video Select Function**

Switch video input source while listening to audio signal.

Press **<VIDEO SELECT>** or **[V.SEL]** until the desired picture appears.

※ To cancel, press **<VIDEO SELECT>** to select "SOURCE".

**Checking the currently playing program source, etc.**

Press **<STATUS>**.  
The current program source and various settings are indicated on the display.  
For details, refer to "Information" (page 33).

**Switching the brightness of the display**

Press **<DIMMER>**.

When setting to "OFF", the display brightness of the menu setting in operation changes to "Dark".

**Playing Video and Audio Equipment**

**Basic Operation**

- 1 Prepare the equipment.**
  - ① Load the DVD, CD or other software in the player. (See the operating instructions of the respective devices.)
  - ② To play a video device, switch the monitor input. (See the monitor's operating instructions.)
- 2 Use SOURCE SELECT to select the input source.**
- 3 Start playback.** (See the operating instructions of the respective devices.)

The remote control unit can be used to operate external devices. See "Remote Control Unit Operations" (page 42).

## Listening to FM/AM Broadcasts

### Basic Operation

- 1** Either turn <SOURCE SELECT> or press [TUNER] to select “TUNER”.
- 2** Set [SOURCE CONTROL 1] to “AUDIO” and [SOURCE CONTROL 2] to “TUNER”.  
(☞ page 42 “Remote Control Unit Operations”)
- 3** Press BAND to select “FM” or “AM”.
- 4** Tune in the desired broadcast station.
  - ① **To tune in automatically (Auto Tuning)**  
Press [MODE] to light the “AUTO” indicator on the display, then use TUNING to select the station you want to hear.
  - ② **To tune in manually (Manual Tuning)**  
Press [MODE] to turn off the display’s “AUTO” indicator, then use TUNING to select the station you want to hear.



- If the desired station cannot be tuned in with auto tuning, tune it in manually.
- When tuning in stations manually, press and hold TUNING to change frequencies continuously.

### Presetting Radio Stations (Preset Memory)

Your favorite broadcast stations can be preset so that you can tune them in easily. Up to 56 stations can be preset.

- 1** Tune in the broadcast station you want to preset.
- 2** Press [MEMORY].
- 3** Press SHIFT to select the block (A to G) in which the station is to be preset.
- 4** Press <PRESET CHANNEL> or [CHANNEL + -] to select the preset number (1 to 8).
- 5** Press [MEMORY] again to complete the setting.



- To preset other stations, repeat steps 1 to 5.
- Stations can be preset automatically at “System Setup” – “Input Setup” – “Auto Preset Memory” (☞ page 24).

#### NOTE

Preset stations are erased by overwriting them.

### Listening to Preset Stations

- 1** Press SHIFT to select the memory block (A to G).
- 2** Press <PRESET CHANNEL> or [CHANNEL + -] to select the desired preset channel (1 to 8).

#### Default settings

Auto tuner presets	
A1 ~ A8	87.5 / 89.1 / 98.1 / 107.9 / 90.1 / 90.1 / 90.1 / 90.1 MHz
B1 ~ B8	520 / 600 / 1000 / 1400 / 1500 / 1710 kHz, 90.1 / 90.1 MHz
C1 ~ C8	90.1 MHz
D1 ~ D8	90.1 MHz
E1 ~ E8	90.1 MHz
F1 ~ F8	90.1 MHz
G1 ~ G8	90.1 MHz

**Symbols used to indicate buttons in this manual**

Button located on both the main unit and the remote control unit → **BUTTON**  
 Button only on the main unit → **<BUTTON>**  
 Button only on the remote control unit → **[BUTTON]**

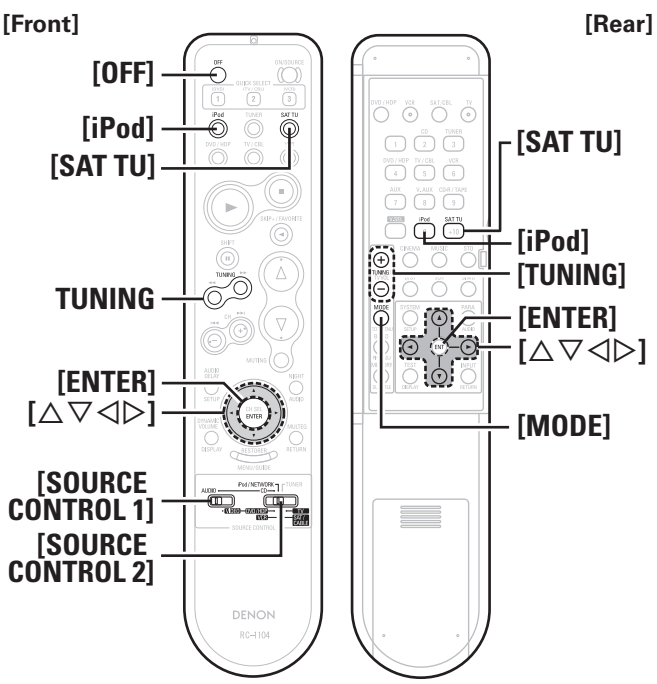
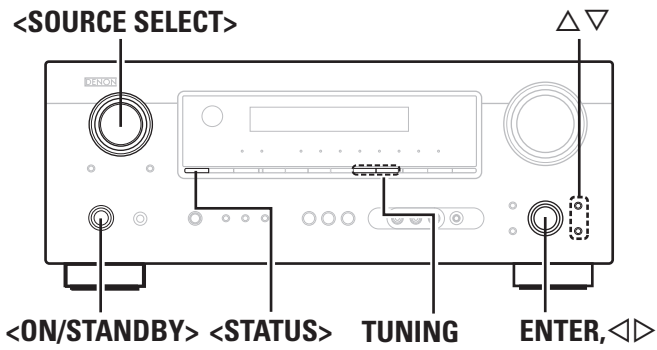

# Listening to SIRIUS Satellite Radio Programs

## What is SIRIUS Satellite Radio?

Simply The Best Radio on Radio™ with all your favorite entertainment including 100% commercial-free music, plus superior sports coverage, uncensored talk and comedy, world-class entertainment, news, weather and more for your car, home or office. For more information visit [sirius.com](http://sirius.com) or [siriuscanada.ca](http://siriuscanada.ca)

Sirius is available in the US for subscribers with addresses in the continental US and is available in Canada for subscribers with a Canadian address. Required subscription plus compatible SIRIUS tuner and antenna are required and sold separately. SIRIUS Programming is subject to change. Visit [sirius.com](http://sirius.com) for the most complete and up-to-date channel lineup and product information. "SIRIUS" and the SIRIUS dog logo and related marks are trademarks of Sirius Satellite Radio Inc. All rights reserved.

## Basic Operation

- 1 Either turn **<SOURCE SELECT>** or press **[SAT TU]** to select "SIRIUS".
- 2 Set **[SOURCE CONTROL 1]** to "AUDIO" and **[SOURCE CONTROL 2]** to "TUNER".  
(☞ page 42 "Remote Control Unit Operations")
- 3 Use **TUNING** to search the channel.  
When selecting channel, the Channel No. and Channel name are displayed.

- The channel switches continuously when **TUNING** is pressed and held.
- SIRIUS Radio stations can be preset using the same procedure as for FM/AM stations (☞ page 36 "Presetting Radio Stations (Preset Memory)" and "Listening to Preset Stations").  
※ You cannot perform "Auto Preset".
- The track name, artist name, composer name, category and reception level can be checked by pressing **<STATUS>**.
- When tuning a channel to which "Parental Lock" is applied, "Code: [ ]" is displayed, so enter the password.

## Checking the SIRIUS Signal Strength and Radio ID

- 1 Either turn **<SOURCE SELECT>** or press **[SAT TU]** to select "SIRIUS".
- 2 Press **<STATUS>** until "SIG." appears on the display.  
The display will switch as shown below, depending on the reception conditions.

Display	Status
EXCELLENT	Signal strength is excellent
GOOD	Signal strength is good
WEAK	Signal strength is weak
NO SIGNAL	No signal

- 3 Adjust the position of the antenna until "SIG.: EXCELLENT" is shown on the display.
- 4 Press **<STATUS>** until the station you want to check (example: "SR001") is displayed.
- 5 Press **TUNING** and select channel 0 (SR000).  
Channel No. and SIRIUS ID are alternately shown on the display.

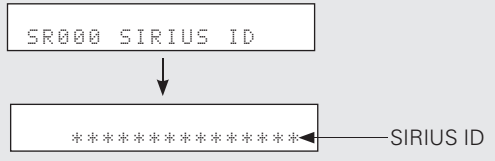

※ Write your own SIRIUS ID for storage use.  
SIRIUS ID : \_\_\_\_\_

**NOTE**  
You can check Satellite and Terrestrial antenna signal strength each time you press **<STATUS>**. (On the display, "S" indicates Satellite, and "T" indicates Terrestrial.)

## Searching Categories

**1** Press [**◀▶**].



**2** Use [**◀▶**] to select the category, then use [**△▽**] to select the desired station.



- “UPDATING” is displayed while the encoding code is being updated.
- “SIRIUS UPDATING” is displayed when updating SIRIUS tuner firmware.
- Refer to “Troubleshooting” (page 52) regarding other messages.

## Parental Lock

**1** Tune to the channel you want to lock.

**2** Press [**ENTER**] for at least 3 seconds.  
“Code: [ ]” is displayed.

**3** Enter the 4-digit lock code using [**△▽◀▶**].  
When you enter the correct code, the corresponding channel is locked.

**4** Press [**ENTER**].



- Channels under Parental Lock cannot be tuned in by performing Tuning Up/Down or by category search.
- Channels stored in preset memory can be tuned in by the preset channel select operation, even if Parental Lock is applied.
- When a channel to which Parental Lock is applied is being played, Parental Lock for that channel is cancelled by performing Step 2.
- See “Edit Lock Cord” (page 25) for the method of changing Parental Lock Cord.
- You can also set “Parental Lock” from the system setup (page 25).

## iPod® Playback

The music on an iPod can be played by using the control dock for iPod (ASD-1R, ASD-3N or ASD-3W, sold separately). The operation can also be performed using the buttons on the remote control unit.



iPod is a trademark of Apple Inc., registered in the U.S. and other countries.

- ※ The iPod may only be used to copy or play contents that are not copyrighted or contents for which copying or playback is legally permitted for your private use as an individual. Be sure to comply with applicable copyright legislation.

## Preparations

**1** Make the necessary preparations.

- ① Set the iPod in the DENON control dock for iPod.  
(See the control dock for iPod’s operating instructions.)
- ② Assign the control dock for iPod’s input.  
The input for the control dock for iPod is assigned to VCR by default.

“System Setup” – “Input Setup” – “iPod Assign”  
(page 24)

**2** Either turn <SOURCE SELECT> or press [**iPod**] to select the input source assigned in step 1-② above.

**3** Set [**SOURCE CONTROL 1**] to “AUDIO” and [**SOURCE CONTROL 2**] to “iPod/NETWORK”.  
(page 42 “Remote Control Unit Operations”)

**4** Press [**MODE**] and hold it down for a 2 seconds or more to select the display mode.

To switch between modes, press and hold down the button. When remote mode is active, “Remote” is displayed.

[Selectable mode]		Browse mode	Remote mode
Display location		Main unit display	iPod display
Playable files	Audio file	<input type="radio"/>	<input type="radio"/>
	Video file	<input type="radio"/> *1	<input type="radio"/> *2
Active buttons	Remote control unit (AVR-589)	<input type="radio"/>	<input type="radio"/>
	iPod	<input checked="" type="radio"/>	<input type="radio"/>

- \*1 : When using an ASD-3N or ASD-3W control dock for iPod.
- \*2 : Video may not be output, depending on the combination of ASD-1R and iPod.



- With the default settings, the iPod can be used connected to the VCR (iPod) connector.
- Use the RESTORER mode to expand the low and high frequency components of compressed audio files and achieve a richer sound. The default setting is “Mode3” (page 32).
- Press <ON/STANDBY> or [**OFF**] and set the AVR-589’s power to the standby mode before disconnecting the iPod. Also switch the input source to one to which “iPod Assign” is not assigned before disconnecting the iPod.
- When using an ASD-3N or ASD-3W control dock for iPod, refer to the respective manual to operate.

**Symbols used to indicate buttons in this manual**

Button located on both the main unit and the remote control unit → **BUTTON**  
 Button only on the main unit → **<BUTTON>**  
 Button only on the remote control unit → **[BUTTON]**

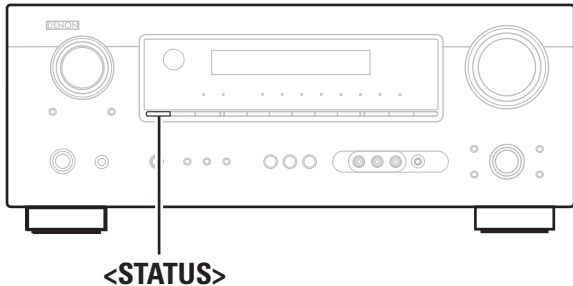

[Front]

[Rear]

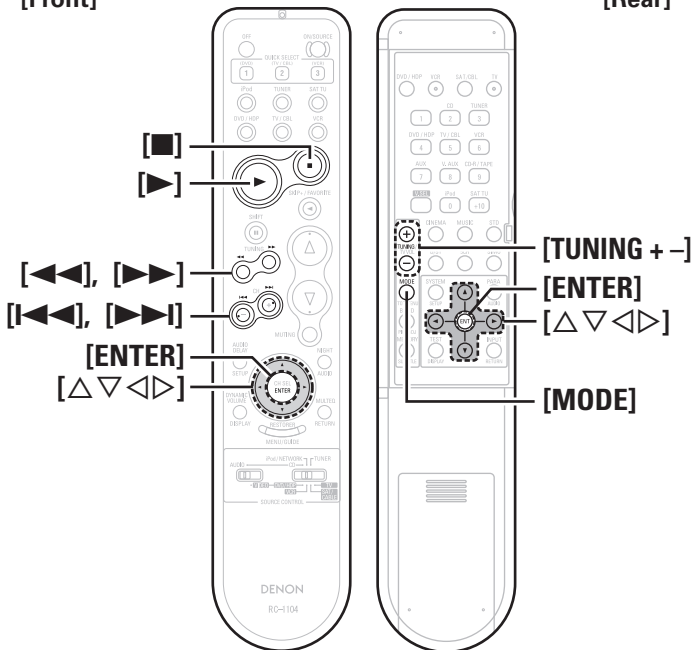

**Listening to Audio**

**1** Use [Δ ▽] to select the item, then press [ENTER] or [▶] to select the music file to be played.

**2** Press [ENTER] or [▶].  
Playback starts.

- Stopping playback temporarily**  
During playback, press [ENTER] or [▶].  
Press again to resume playback.
- Fast-forwarding or fast-reversing**  
During playback, press and hold [◀◀] (to fast-reverse) or [▶▶] (to fast-forward).
- To cue to the beginning of a track**  
During playback, press [◀◀] or [▶▶].
- To stop**  
During playback, either press and hold [ENTER] or press [■].
- Playing repeatedly**  
Press [TUNING -].

[Selectable items] **All One OFF**

- Shuffling playback**  
Press [TUNING +].

[Selectable items] **Albums Songs OFF**

- To check the name of the title, the artist or the album when playing in browse mode, press <STATUS>.
- The folder name and the file name can be displayed in browse mode. Only alphanumeric characters and certain symbols can be displayed. Any characters that cannot be displayed are replaced with ". (period)".

**NOTE**

- Depending on the type of iPod and the software version, some functions may not operate.
- DENON will accept no responsibility whatsoever for any loss of iPod data.

**Viewing Still Pictures or Videos on the iPod**

Photo and video data on the iPod can be viewed on the monitor. Only for iPod equipped with slideshow or video functions.

**When using an ASD-1R**

- 1** Press and hold [MODE] to set the Remote mode.
- 2** Watching the iPod's screen, use [Δ ▽] to select "Photos" or "Videos".
- 3** Press [ENTER] until the image you want to view is displayed.

"TV Out" at the iPod's "Slideshow Settings" or "Video Settings" must be set to "On" in order to display the iPod's photo data or videos on the monitor. For details, see the iPod's operating instructions.

**When using an ASD-3N or ASD-3W**

- 1** Press and hold [MODE] to set the Browse mode.
- 2** Watching the display, use [Δ ▽] to select "iPod", then press [▶] or [ENTER].
- 3** Use [Δ ▽] to select "Video", then press [▶] or [ENTER].
- 4** Use [Δ ▽] to select the video file to be played, then press [▶] or [ENTER].

When viewing a still picture, perform the same operation as with ASD-1R.

# Other Operations and Functions

**Symbols used to indicate buttons in this manual**

- Button located on both the main unit and the remote control unit → **BUTTON**
- Button only on the main unit → **<BUTTON>**
- Button only on the remote control unit → **[BUTTON]**

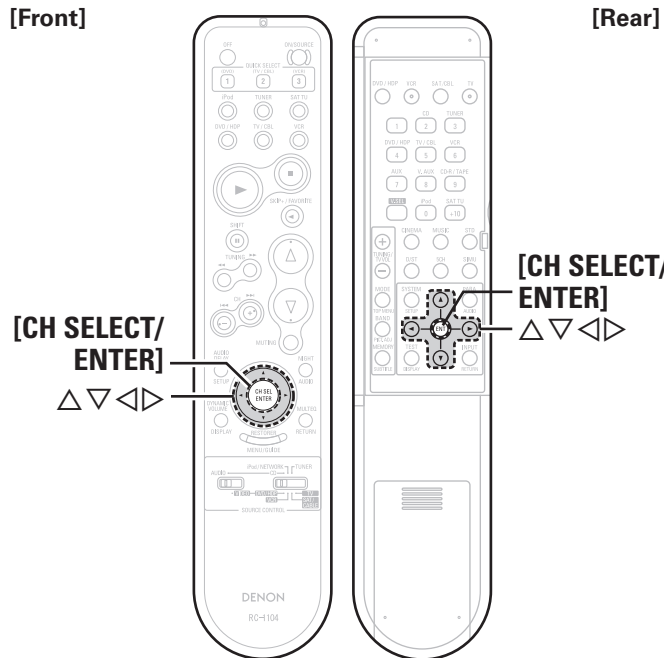
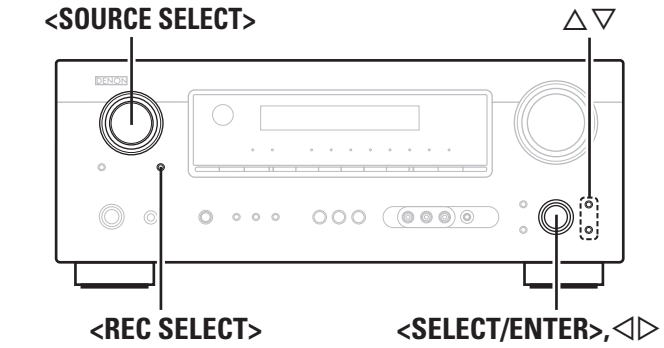

## Other Operations

### Recording on an External Device (REC OUT mode)

You can listen to one program source while recording a different program source.

- 1 Press <REC SELECT> until "RECOUT" appears on the display.**
- 2 Turn <SOURCE SELECT> to choose the input source to be recorded.**  
The "REC" indicator and the indicator for the selected source light.  
RECOUT SOURCE ↔ RECOUT TUNER ↔ ..... ↔ RECOUT SIRIUS
- 3 Play the program source.**  
For operating instructions, refer to the respective equipment's operating instructions.  
To record FM or AM broadcasts, select the broadcast (page 36).
- 4 Start recording.**  
For operating instructions, refer to the respective equipment's operating instructions.



- To cancel, press <REC SELECT>, then turn <SOURCE SELECT> until "RECOUT SOURCE" is displayed.
- Make a test recording before starting the actual recording.

**NOTE**

- Recordings you make are for your personal enjoyment and should not be used for other purposes without permission of the copyright holder.
- Digital signals are not output from the REC OUT (CDR/TAPE and VCR) connector.
- Audio and video signals input from the VCR IN connector are not output from the VCR OUT connector. Audio signal input from the CD-R/TAPE IN connector are not output from the CD-R/TAPE OUT connector.

## Convenient Functions

### Channel Level

You can adjust the channel level either according to the playback sources or to suit your taste, as described below.

- 1 Press <SELECT/ENTER> or [CH SELECT/ENTER].**

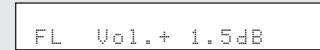

- 2 Use Δ∇, <SELECT/ENTER> or [CH SELECT/ENTER] to select the speaker.**  
The speaker that can be set switches each time one of the buttons is pressed.

- 3 Use <Δ><∇> to adjust the volume.**

※ In the case of a subwoofer, reducing the volume when it is at "-12 dB" will change the setting to OFF (none).

Getting Started  
Connections  
Setup  
Playback  
Remote Control  
Information  
Troubleshooting  
Specifications

**Symbols used to indicate buttons in this manual**

Button located on both the main unit and the remote control unit → **BUTTON**  
 Button only on the main unit → **<BUTTON>**  
 Button only on the remote control unit → **[BUTTON]**

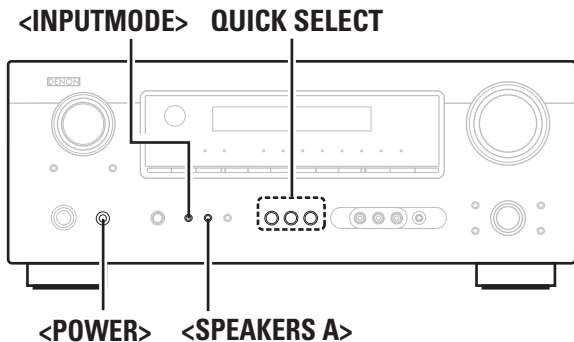

[Front]

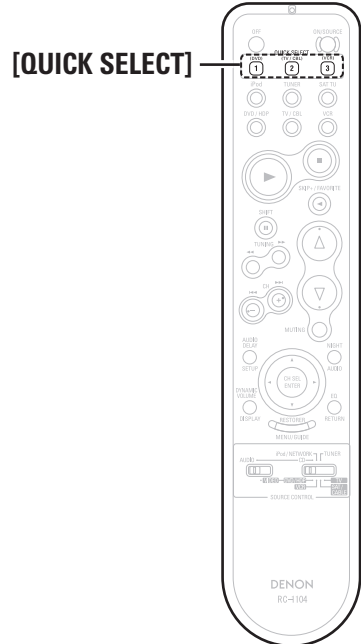

### Quick Select Function

With this function, the currently playing input source, volume level, surround mode, MultEQ, Dynamic Volume, DV setting and front speaker can be stored in the memory.

- 1 Set the input source, input mode, surround mode, MultEQ settings and volume to the conditions you want to store.**
- 2 Press and hold QUICK SELECT until “Memory” appears on the display.**  
The current settings will be memorized.

**[Quick Select Defaults]**

	Input Source	Volume
<b>Quick Select 1</b>	DVD/HDP	-40 dB
<b>Quick Select 2</b>	TV/CBL	-40 dB
<b>Quick Select 3</b>	VCR	-40 dB

To call out the settings, press **QUICK SELECT** at which the desired settings were stored.

### Personal Memory Plus Function

This function sets the settings (input mode, surround mode, MultEQ, Dynamic EQ, Dynamic Volume, audio delay etc.) last selected for the individual input sources. When you switch to an input source, the settings are automatically set to the ones that were set the last time that input source was used.

The surround parameters, tone control, MultEQ settings and the volumes of the different speakers are stored for the individual surround modes.

### Last Function Memory

This stores the settings as they were directly before the standby mode was set. When the power is turned back on, the settings are restored to as they were directly before the standby mode was set.

### Backup Memory

The various settings are backed up for about 1 week, even if the power is turned off or the power cord is disconnected.

### Resetting the Microprocessor

Perform this procedure if the display is abnormal or if operations cannot be performed. When the microprocessor is reset, all the settings are reset to their default values.

- 1 Turn off the power using <POWER>.**
- 2 Press <POWER> while simultaneously pressing <INPUT MODE> and <SPEAKERS A>.**
- 3 Once the display starts flashing at intervals of about 1 second, release the two buttons.**

If in step 3 the display does not flash at intervals of about 1 second, start over from step 1.

# Remote Control Unit Operations

[Front]

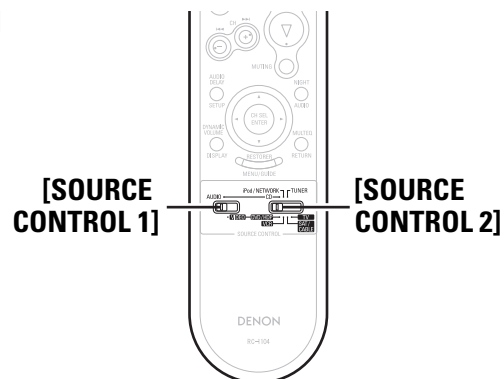

[Rear]

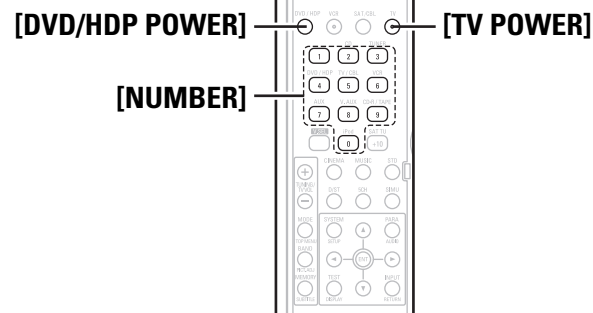

Depending on the model and year of manufacture of your equipment, some buttons may not operate.

## Operating DENON Audio Components

- 1** Set **[SOURCE CONTROL 1]** to “AUDIO”.
- 2** Set **[SOURCE CONTROL 2]** to the position for the component to be operated (CD, iPod/NETWORK or TUNER).
- 3** Operate the audio component.
  - ※ For details, refer to the component’s operating instructions.
  - ※ While this remote control unit is compatible with a wide range of infrared controlled components, it may be the case that some component models cannot be operated with this remote control unit.



- The signals for the pressed buttons are emitted while setting the preset memory. To avoid accidental operation, cover the remote control unit’s transmitting window while setting the preset memory.
- Depending on the model and year of manufacture, this function cannot be used for some models, even if they are of makes listed in the list of preset codes.
- Some manufacturers use more than one type of remote control code. Refer to the included list of preset codes to change the number and verify correct operation.
- The preset memory can be set for one component only among the following: DVD/HDP and SAT/CABLE.
- VDP (Video Disc Player) can be preset when **[SOURCE CONTROL 2]** is set to “DVD/HDP”.

## Operating Preset Components

### Presetting

- DENON and other makes of components can be operated by setting the preset memory.
- Operation is not possible for some models.

- 1** Set **[SOURCE CONTROL 1]** to “AUDIO” or “VIDEO”.
  - ※ Set to the AUDIO side for the CD position, and to the VIDEO side for the DVD/HDP, VCR, SAT/CABLE or TV position.
- 2** Set **[SOURCE CONTROL 2]** to the component to be registered.
- 3** Press **[DVD/HDP POWER]** and **[TV POWER]** at the same time.
 

The indicator starts flashing.
- 4** Press **[NUMBER]** and input the 3-digit number of the brand of the component to be preset. The numbers are shown in the Preset Code Table (📖 End of this manual).
- 5** To store the codes of another component in the memory, repeat steps 1 to 4.

- 1** Set **[SOURCE CONTROL 1]** to “AUDIO” or “VIDEO”.
  - ※ Set to the AUDIO side for the CD position, and to the VIDEO side for the DVD/HDP, VCR, SAT/CABLE or TV position.
- 2** Set **[SOURCE CONTROL 2]** to the component you want to operate.
- 3** Operate the component.
  - ※ For details, refer to the component’s operating instructions.
  - ※ Some models cannot be operated with this remote control unit.

□ Front

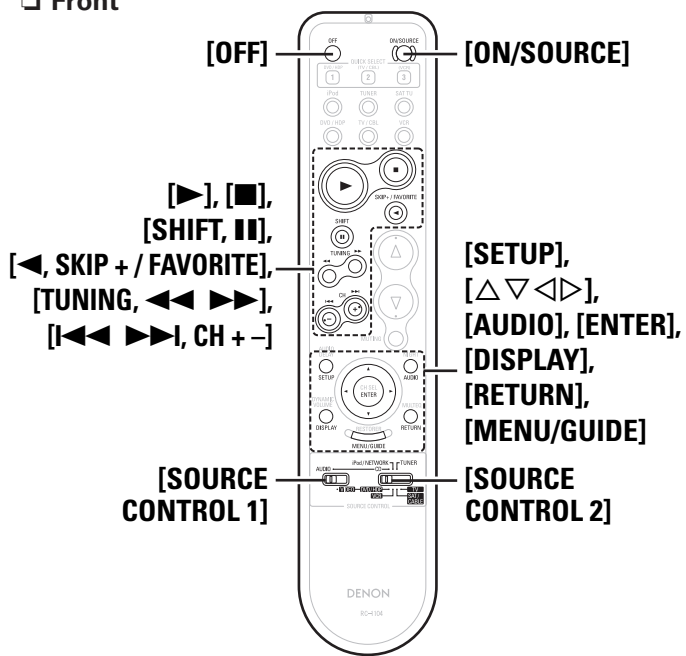

□ Rear

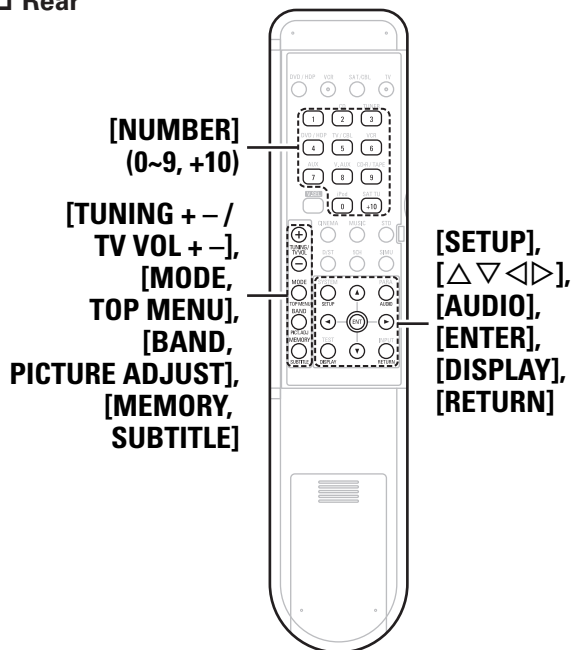

Functions of Buttons by Component

□ Front

Device operated	CD Player	iPod	Tuner	DVD Player	Blu-ray Disc Player	Video Disc Player (VDP)	Video Deck	Satellite Receiver	Cable TV	TV (Monitor)
<b>SOURCE CONTROL 1</b>	AUDIO			VIDEO						
<b>SOURCE CONTROL 2</b>	CD	iPod/ NETWORK	TUNER	DVD / HDP			VCR	SAT / CABLE		TV
<b>OFF</b>	-	-	-	Power off	Power off	-	-	-	-	-
<b>ON/SOURCE</b>	-	-	-	Power on	Power on	Power on / Standby	Power on / Standby	Power on / Standby	Power on / Standby	Power on / Standby
<b>▶</b>	Play	Play / Pause	-	Play	Play	Play	Play	Punch through	Punch through	Punch through
<b>■</b>	Stop	Stop	-	Stop	Stop	Stop	Stop			
<b>SHIFT, II</b>	Pause	-	Shift	Pause	Pause	Pause	Pause			
<b>◀, SKIP + / FAVORITE</b>	Disc skip +	※ Favorites Direct	-	Disc skip	-	-	-	Punch through	Punch through	Punch through
<b>TUNING, &lt;&lt;&gt;&gt;</b>	Manual search (fast-reverse / fast-forward)	Manual search (fast-reverse / fast-forward)	Tuning down / up	Manual search (fast-reverse / fast-forward)	Manual search (fast-reverse / fast-forward)	Manual search (fast-reverse / fast-forward)	Manual search (fast-reverse / fast-forward)			
<b>I&lt;&lt;&gt;&gt;I, CH + -</b>	Auto search (cue)	Auto search (cue)	Tuner Channel - / +	Auto search (cue)	Auto search (cue)	Auto search (cue)	Switch channels (-, +)	Punch through	Punch through	Punch through
<b>SETUP</b>	-	-	-	Setup	Setup	-	-			
<b>Δ▽◁▷</b>	-	Cursor	-	Cursor operation	Cursor operation	-	-	Cursor operation	Cursor operation	Cursor operation
<b>AUDIO</b>	-	-	-	Switching the audio signal	Switching the audio signal	-	-	-	-	-
<b>ENTER</b>	-	Enter	-	Enter setting	Enter setting	-	-	Enter setting	Enter setting	Enter setting
<b>DISPLAY</b>	-	-	-	Switching the display	Switching the display	-	-	Switching the display	Switching the display	Switching the display
<b>RETURN</b>	-	-	-	Return	Return	-	-	Return	Return	Return
<b>MENU / GUIDE</b>	-	-	-	Calling out the menus	Calling out the menus	-	-	Calling out the menus	Calling out the menus	Calling out the menus

※ The iPod/NETWORK's **FAVORITE** button can be operated when using a control dock for iPod ASD-3N/3W.

□ Rear

Device operated	CD Player	iPod	Tuner	DVD Player	Blu-ray Disc Player	Video Disc Player (VDP)	Video Deck	Satellite Receiver	Cable TV	TV (Monitor)
<b>SOURCE CONTROL 1</b>	AUDIO			VIDEO						
<b>SOURCE CONTROL 2</b>	CD	iPod/ NETWORK	TUNER	DVD / HDP			VCR	SAT / CABLE		TV
<b>POWER</b>	–	–	–	Power on/off	Power on/off	Power on/off	Power on/off	Power on/off	Power on/off	Power on/off
<b>NUMBER (0 ~ 9, +10)</b>	–	–	–	Number input / Track selection	Number input / Track selection	Number input / Track selection	–	Channels	Channels	Channels
<b>TUNING (+, -) / TV VOL (+, -)</b>	⊕ CD Random ⊖ CD Repeat	⊕ iPod Random ⊖ iPod Repeat	⊕ Tuning up ⊖ Tuning down	⊕ DVD Random ⊖ DVD Repeat	⊕ Blu-ray Disc Random ⊖ Blu-ray Disc Repeat	⊕ TV Volume ▲ ⊖ TV Volume ▼	⊕ TV Volume ▲ ⊖ TV Volume ▼	⊕ DBS Volume ▲ ⊖ DBS Volume ▼	⊕ Cable Volume ▲ ⊖ Cable Volume ▼	⊕ TV Volume ▲ ⊖ TV Volume ▼
<b>MODE, TOP MENU</b>	–	Page search mode (once) and Browse/Remote mode switching (Press and hold)	Switch search modes	Calling out the menus	Calling out the top menus	–	–	Calling out the menus	Calling out the menus	Calling out the menus
<b>SETUP</b>	–	–	–	Setup	Setup	–	–	–	–	–
△▽◀▶	–	–	–	Cursor operation	Cursor operation	–	–	Cursor operation	Cursor operation	Cursor operation
<b>AUDIO</b>	–	–	–	Audio	Audio	–	–	–	–	–
<b>BAND, PICTURE ADJUST</b>	–	※1 Top menu	AM / FM switching	Picture adjust	Picture adjust	–	–	–	–	–
<b>ENTER</b>	–	–	–	Enter setting	Enter setting	–	–	Enter setting	Enter setting	Enter setting
<b>MEMORY, SUBTITLE</b>	–	※1 Favorite memory	Preset memory	Subtitle	Subtitle	–	–	–	–	–
<b>DISPLAY</b>	–	–	–	Switching the display	Switching the display	–	–	Switching the display	Switching the display	Switching the display
<b>RETURN</b>	–	–	–	Return	Return	–	–	Return	Return	Return
<b>Default setting (Preset code)</b>	DENON (111)	–	–	DENON (111)	※2 DENON (121)	–	HITACHI (108)	–	ABC (007)	HITACHI (134)
<b>Special Remarks</b>	①	–	–	①, ②			①	①, ③		①, ③

**[Special Remarks]**

- ① Only one device can be set in the preset memory for each mode. When a new preset code is registered, the existing code is automatically erased.
- ② For some brands, the DVD remote control buttons may have different function names. Check beforehand.
- ③ One of the following buttons can be assigned to the TV and satellite receiver or cable TV: CD, iPod/NETWORK, TUNER, DVD/HDP, VCR (☞ page 44 “Punch Through Function”).

※1: This button can be operated when using a control dock for iPod ASD-3N/3W.

※2: The initial setting of Preset code is 111 (DVD Player). With the Blu-ray Disc Player setting, when you have set the remote controller code to “DENON2”, use the Blu-ray Disc Player preset code “121”.

## Punch Through Function

“Punch Through” is a function allowing you to operate ▶, ■, ||, ◀, ◀◀, ▶▶, ◀◀◀ and ▶▶▶ on CD, iPod/NETWORK, TUNER, DVD/HDP or VCR components when in the SAT/CABLE or TV mode. By default, nothing is set.

- 1** Set **[SOURCE CONTROL 1]** to “VIDEO”.
- 2** Set **[SOURCE CONTROL 2]** to the component to be registered (SAT/CABLE or TV).
- 3** Press **[MEMORY]** and **[RETURN]** at the same time. The indicator starts flashing.
- 4** Input the number of the component you want to set.

	No.
CD	1
iPod/NETWORK	2
TUNER	3
DVD/HDP	4
VCR	5
No setting	0

## Other Information

### About Speaker Installation

#### Examples of speaker layouts

Below we introduce examples of speaker layouts. Refer to these to arrange your speakers according to their type and how you want to use them.

#### Basic setting

DTS 96/24 is a digital audio format enabling high sound quality playback in 5.1-channels with a sampling frequency of 96 kHz and 24 bit quantization on DVD-Video.

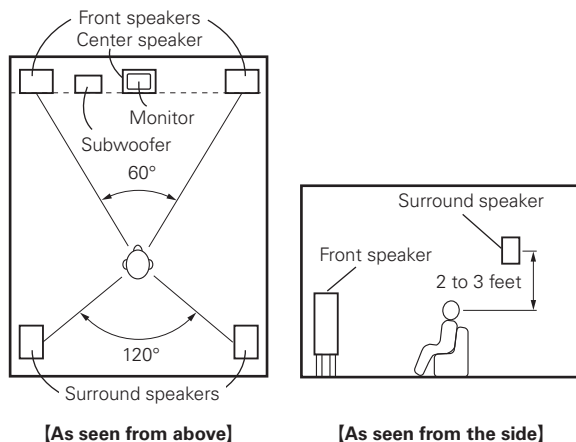

### Surround

The AVR-589 is equipped with a digital signal processing circuit that lets you play program sources in the surround mode to achieve the same sense of presence as in a movie theater.

#### Dolby Surround

#### Dolby Digital

Dolby Digital is a multichannel digital signal format developed by Dolby Laboratories.

A total of 5.1-channels are played: 3 front channels ("FL", "FR" and "C"), 2 surround channels ("SL" and "SR") and the "LFE" channel for low frequencies.

Because of this, there is no crosstalk between channels and a realistic sound field with a "three-dimensional" feeling (sense of distance, movement and positioning) is achieved.

A real, overpowering sense of presence is achieved when playing movie sources in AV rooms as well.

#### Dolby Pro Logic II

Dolby Pro Logic II is a matrix decoding technology developed by Dolby Laboratories.

Regular music such as that on CDs is encoded into 5-channels to achieve an excellent surround effect.

The surround channel signals are converted into stereo and full band signals (with a frequency response of 20 Hz to 20 kHz or greater) to create a "three-dimensional" sound image offering a rich sense of presence for all stereo sources.

Manufactured under license from Dolby Laboratories.  
"Dolby", "Pro Logic" and the double-D symbol are trademarks of Dolby Laboratories.

### DTS Surround

#### DTS Digital Surround

DTS Digital Surround is the standard digital surround format of DTS, Inc., compatible with a sampling frequency of 44.1 or 48 kHz and up to 5.1-channels of digital discrete surround sound.

#### DTS NEO:6™ Surround

DTS NEO:6™ is a matrix decoding technology for achieving 5.1-channel surround playback with 2-channel sources. It includes "DTS NEO:6 Cinema" suited for playing movies and "DTS NEO:6 Music" suited for playing music.

#### DTS 96/24

DTS 96/24 is a digital audio format enabling high sound quality playback in 5.1-channels with a sampling frequency of 96 kHz and 24 bit quantization on DVD-Video.

Manufactured under license under U.S. Patent #'s: 5,451,942; 5,956,674; 5,974,380; 5,978,762; 6,487,535; 7,003,467 & other U.S. and worldwide patents issued & pending. DTS, DTS Digital Surround, and Neo:6 are registered trademarks and the DTS logos, Symbol and DTS 96/24 are trademarks of DTS, Inc. ©1996-2007 DTS, Inc. All Rights Reserved.

## Audyssey

### Audyssey MultEQ®

Audyssey MultEQ is a room equalization solution that calibrates any audio system so that it can achieve optimum performance for every listener in a large listening area. Based on several room measurements, MultEQ calculates an equalization solution that corrects for both time and frequency response problems in the listening area and also performs a fully automated surround system setup.

### Audyssey Dynamic EQ™

Audyssey Dynamic EQ solves the problem of deteriorating sound quality as volume is decreased by taking into account human perception and room acoustics. Audyssey Dynamic EQ works in tandem with Audyssey MultEQ to provide well-balanced sound for every listener at any volume level.

### Audyssey Dynamic Volume™

Audyssey Dynamic Volume solves the problem of large variations in volume level between television programs, commercials, and between the soft and loud passages of movies.

Audyssey Dynamic EQ is integrated into Dynamic Volume so that as the playback volume is adjusted automatically, the perceived bass response, tonal balance, surround impression, and dialog clarity remain the same.



Manufactured under license from Audyssey Laboratories. U.S. and foreign patents pending. Audyssey MultEQ® is a registered trademark of Audyssey Laboratories. Audyssey Dynamic EQ™ is a trademark of Audyssey Laboratories. Audyssey Dynamic Volume™ is a trademark of Audyssey Laboratories.

## HDMI (High-Definition Multimedia Interface)

HDMI is a digital interface standard for next generation TVs based on DVI (Digital Visual Interface) standards and optimized for use in consumer equipment.

Non-compressed digital video and multi-channel audio signals are transmitted with a single connection.

HDMI is also compatible with HDCP (High-bandwidth Digital Contents Protection), a technology for protecting copyrights that encrypts digital video signals in the same way as with DVI.

### Deep Color

Eliminates on-screen color banding, for smooth tonal transitions and subtle gradations between colors.

Enables increased contrast ratio.

Can represent many times more shades of gray between black and white.

At 30-bit pixel depth, a four times improvement would be the minimum, and the typical improvement would be eight times or more.

### xvYCC

Next-generation “xvYCC” color space supports 1.8 times as many colors as existing HDTV signals.

Lets HDTVs display colors more accurately.

Enables displays with natural, vivid colors.

“HDMI”, “HDMI logo” and “High-Definition Multimedia Interface” are trademarks or registered trademarks of HDMI Licensing LLC.

## Surround Modes and Parameters

Surround mode	Signals and adjustability in the different modes											
	Channel output				Parameter (default values are shown in parentheses)							
	Front L/R	Center	Surround L/R	Subwoofer	D. Comp *1	LFE *1	Cinema EQ.	Mode	Room Size	Effect Level	Delay Time	Subwoofer
DIRECT	○	×	×	⊙	○ (OFF)	○ (0 dB)	×	×	×	×	×	○
STEREO	○	×	×	⊙	○ (OFF)	○ (0 dB)	×	×	×	×	×	×
EXT. IN	○	⊙	⊙	⊙	×	×	×	×	×	×	×	×
DOLBY PRO LOGIC II	○	⊙	⊙	⊙	○ (OFF)	×	○ (OFF, NOTE2)	○	×	×	×	×
DTS NEO:6	○	⊙	⊙	⊙	○ (OFF)	×	○ (OFF, NOTE1)	○	×	×	×	×
DOLBY DIGITAL	○	⊙	⊙	⊙	○ (OFF)	○ (0 dB)	○ (OFF)	×	×	×	×	×
DTS SURROUND	○	⊙	⊙	⊙	×	○ (0 dB)	○ (OFF)	×	×	×	×	×
5CH STEREO	○	⊙	⊙	⊙	○ (OFF)	○ (0 dB)	×	×	×	×	×	×
ROCK ARENA	○	⊙	⊙	⊙	○ (OFF)	○ (0 dB)	×	×	○ (Medium)	○ (10)	×	×
JAZZ CLUB	○	⊙	⊙	⊙	○ (OFF)	○ (0 dB)	×	×	○ (Medium)	○ (10)	×	×
MONO MOVIE	○	⊙	⊙	⊙	○ (OFF)	○ (0 dB)	×	×	○ (Medium)	○ (10)	×	×
VIDEO GAME	○	⊙	⊙	⊙	○ (OFF)	○ (0 dB)	×	×	○ (Medium)	○ (10)	×	×
MATRIX	○	⊙	⊙	⊙	○ (OFF)	○ (0 dB)	×	×	×	×	○ (30 ms)	×
VIRTURL	○	×	×	⊙	○ (OFF)	○ (0 dB)	×	×	×	×	×	×

○ : Signal / Adjustable  
 × : No signal / Not adjustable  
 ⊙ : Turned on or off by speaker configuration setting

○ : Enable  
 × : Unable  
 NOTE1 : This parameter is available when "Surround Parameter" – "Mode" is set to "Cinema" (page 30).  
 NOTE2 : This parameter is available when "Surround Parameter" – "Mode" is set to "Cinema" or "PL" (page 30).

**NOTE:**  
 \*1 : When playing Dolby Digital and DTS signals.

Surround mode	Signals and adjustability in the different modes											
	Parameter (default values are shown in parentheses)											
	PRO LOGIC II MUSIC mode only			NEO:6 MUSIC mode only	EXT. IN only	Tone Control (NOTE5)	Night Mode (NOTE5)	MultEQ	Dynamic EQ (NOTE6)	Dynamic Volume (NOTE7)	DV Setting	RESTORER
Panorama	Dimension	Center Width	Center Image	SUBWOOFER ATT.								
DIRECT	×	×	×	×	×	×	○ (OFF)	○ (OFF, NOTE4)	○ (ON, NOTE4)	○ (OFF, NOTE4)	○ (Midnight, NOTE8)	×
STEREO	×	×	×	×	×	○ (0 dB)	○ (OFF)	○ (OFF, NOTE9)	○ (ON, NOTE9)	○ (OFF, NOTE9)	○ (Midnight, NOTE8)	○ (OFF, NOTE10)
EXT. IN	×	×	×	×	○	×	×	×	×	×	×	×
DOLBY PRO LOGIC II	○ (OFF)	○ (3)	○ (3)	×	×	○ (0 dB)	○ (OFF)	○ (OFF, NOTE9)	○ (ON, NOTE9)	○ (OFF, NOTE9)	○ (Midnight, NOTE8)	○ (OFF, NOTE10)
DTS NEO:6	×	×	×	○ (0,3)	×	○ (0 dB)	○ (OFF)	○ (OFF, NOTE9)	○ (ON, NOTE9)	○ (OFF, NOTE9)	○ (Midnight, NOTE8)	○ (OFF, NOTE10)
DOLBY DIGITAL	×	×	×	×	×	○ (0 dB)	○ (OFF)	○ (OFF, NOTE9)	○ (ON, NOTE9)	○ (OFF, NOTE9)	○ (Midnight, NOTE8)	×
DTS SURROUND	×	×	×	×	×	○ (0 dB)	○ (OFF)	○ (OFF, NOTE9)	○ (ON, NOTE9)	○ (OFF, NOTE9)	○ (Midnight, NOTE8)	×
5CH STEREO	×	×	×	×	×	○ (0 dB)	○ (OFF)	○ (OFF, NOTE9)	○ (ON, NOTE9)	○ (OFF, NOTE9)	○ (Midnight, NOTE8)	○ (OFF, NOTE10)
ROCK ARENA	×	×	×	×	×	○ (NOTE3)	○ (OFF)	○ (OFF, NOTE9)	○ (ON, NOTE9)	○ (OFF, NOTE9)	○ (Midnight, NOTE8)	○ (OFF, NOTE10)
JAZZ CLUB	×	×	×	×	×	○ (0 dB)	○ (OFF)	○ (OFF, NOTE9)	○ (ON, NOTE9)	○ (OFF, NOTE9)	○ (Midnight, NOTE8)	○ (OFF, NOTE10)
MONO MOVIE	×	×	×	×	×	○ (0 dB)	○ (OFF)	○ (OFF, NOTE9)	○ (ON, NOTE9)	○ (OFF, NOTE9)	○ (Midnight, NOTE8)	○ (OFF, NOTE10)
VIDEO GAME	×	×	×	×	×	○ (0 dB)	○ (OFF)	○ (OFF, NOTE9)	○ (ON, NOTE9)	○ (OFF, NOTE9)	○ (Midnight, NOTE8)	○ (OFF, NOTE10)
MATRIX	×	×	×	×	×	○ (0 dB)	○ (OFF)	○ (OFF, NOTE9)	○ (ON, NOTE9)	○ (OFF, NOTE9)	○ (Midnight, NOTE8)	○ (OFF, NOTE10)
VIRTURL	×	×	×	×	×	○ (0 dB)	○ (OFF)	○ (OFF, NOTE9)	○ (ON, NOTE9)	○ (OFF, NOTE9)	○ (Midnight, NOTE8)	○ (OFF, NOTE10)

○ : Adjustable

× : Not adjustable

NOTE3 : BASS +6 dB, TREBLE +4 dB

NOTE4 : When "System Setup" – "Option Setup" – "Direct Mode Setup" are turned "ON", also after implementing "Auto Setup".

NOTE5 : This parameter is not available when "Surround Parameter" – "Dynamic EQ" is set to "ON" (page 31).

NOTE6 : This parameter is not available when "Surround Parameter" – "MultEQ" is set to "OFF" (page 31).

NOTE7 : This parameter is not available when "Surround Parameter" – "Dynamic EQ" is set to "OFF" (page 31).

NOTE8 : Displayed when "Dynamic Volume" setting is "ON".

NOTE9 : Displays after implementing Auto Setup.

NOTE10 : Displayed when input signal is "Analog" or "PCM 44.1/48 kHz".

Differences in Surround Mode Names Depending on the Input Signals

Button	Input signals							
	ANALOG	LINEAR PCM	LINEAR PCM (Multi ch)	DTS (5.1ch)	DTS 96/24	DOLBY DIGITAL (5.1/5/4ch)	DOLBY DIGITAL (4/3ch)	DOLBY DIGITAL (2ch)
STANDARD								
DTS SURROUND								
DTS SURROUND	×	×	×	◎	×	×	×	×
DTS 96/24	×	×	×	×	◎	×	×	×
DTS NEO:6 CINEMA	○	○	×	×	×	×	×	○
DTS NEO:6 MUSIC	○	○	×	×	×	×	×	○
DOLBY Surround								
DOLBY DIGITAL	×	×	×	×	×	◎	◎	×
DOLBY PLII CINEMA	○	○	×	×	×	×	×	◎
DOLBY PLII MUSIC	○	○	×	×	×	×	×	○
DOLBY PLII GAME	○	○	×	×	×	×	×	○
DOLBY PRO LOGIC	○	○	×	×	×	×	×	○
DIRECT								
DIRECT	○	○	×	○	○	○	○	○
DSP SIMULATION								
5CH STEREO	○	○	×	○	○	○	○	○
ROCK ARENA	○	○	×	○	○	○	○	○
JAZZ CLUB	○	○	×	○	○	○	○	○
MONO MOVIE	○	○	×	○	○	○	○	○
VIDEO GAME	○	○	×	○	○	○	○	○
MATRIX	○	○	×	○	○	○	○	○
VIRTUAL	○	○	×	○	○	○	○	○
STEREO								
STEREO	◎	◎	×	○	○	○	○	○

◎ : Mode selectable in initial status  
 ○ : Selectable mode  
 × : Non-selectable mode

# Troubleshooting

If a problem should arise, first check the following:

1. Are the connections correct?
2. Is the set being operated as described in the owner's manual?
3. Are the other components operating properly?

If this unit does not operate properly, check the items listed in the table below. Should the problem persist, there may be a malfunction.

In this case, disconnect the power immediately and contact your store of purchase.

## [General]

Symptom	Cause	Countermeasure	Page
Set does not operate properly.	<ul style="list-style-type: none"> <li>External noise or interference is causing the set to malfunction.</li> </ul>	<ul style="list-style-type: none"> <li>Reset the microprocessor.</li> </ul>	41
Power does not turn on, or turns off directly after it was turned on.	<ul style="list-style-type: none"> <li>Connection of the power cord is faulty.</li> </ul>	<ul style="list-style-type: none"> <li>Check the insertion of the power cord plug.</li> </ul>	15
No sound is produced from speakers.	<ul style="list-style-type: none"> <li>Connection with the input devices or connection of the speaker cables is faulty.</li> </ul>	<ul style="list-style-type: none"> <li>Check the connections.</li> </ul>	9 ~ 15
		<ul style="list-style-type: none"> <li>Select an appropriate input source.</li> </ul>	34
		<ul style="list-style-type: none"> <li>Adjust the master volume to an appropriate level.</li> </ul>	35
		<ul style="list-style-type: none"> <li>Cancel the mute mode.</li> </ul>	35
		<ul style="list-style-type: none"> <li>Disconnect the headphones.</li> </ul>	35
<ul style="list-style-type: none"> <li>Headphones are connected.</li> <li>No digital signals are being input.</li> </ul>	<ul style="list-style-type: none"> <li>Select an input source for which the digital input setting has been made.</li> </ul>	24	
	<ul style="list-style-type: none"> <li>Set the input mode.</li> </ul>	34	
<ul style="list-style-type: none"> <li>The connectors to which the digital inputs are assigned and the settable input modes do not match.</li> </ul>			
Display is off.	<ul style="list-style-type: none"> <li>The Dimmer setting is set to "OFF".</li> </ul>	<ul style="list-style-type: none"> <li>Set to something other than "OFF".</li> </ul>	35
"DOLBY DIGITAL" indicator does not appear on display.	<ul style="list-style-type: none"> <li>DVD player's digital audio output setting is not proper.</li> </ul>	<ul style="list-style-type: none"> <li>Check the DVD player's audio output setting. For details, read the DVD player's operating instructions.</li> </ul>	-
Power switches off suddenly while you are using the AVR-589, the power indicator will flash in red at intervals of approximately 2 seconds.	<ul style="list-style-type: none"> <li>The protection circuit will be activated depending upon the temperature rise in the internal parts of the unit.</li> </ul>	<ul style="list-style-type: none"> <li>Please switch off power at once, and re-apply the power after the body temperature has fallen sufficiently.</li> </ul>	9
		<ul style="list-style-type: none"> <li>Please re-install AVR-589 in a place having good ventilation.</li> </ul>	-

Symptom	Cause	Countermeasure	Page
Power switches off suddenly while you are using the AVR-589, the power indicator will flash red at intervals of approximately 0.5 seconds.	<ul style="list-style-type: none"> <li>Use speakers having impedance less than that specified.</li> <li>If speaker cable core wires touch each other or the core wires become disconnected from their terminals, the protection circuit will be activated in the event of core wires coming into contact with the AVR-589 rear panel.</li> </ul>	<ul style="list-style-type: none"> <li>Please use speakers which have the specified impedance.</li> </ul>	9
		<ul style="list-style-type: none"> <li>Unplug the power cord, then after twisting the core wires together tightly again, or effecting termination treatments etc, please reconnect once again.</li> </ul>	9
Even applying power, the power display flashes red at intervals of approximately 0.5 seconds.	<ul style="list-style-type: none"> <li>The AVR-589 amplifier circuit has failed.</li> </ul>	<ul style="list-style-type: none"> <li>Switch off the power and please contact the DENON service adviser.</li> </ul>	-

## [Remote Control Unit]

Symptom	Cause	Countermeasure	Page
Set does not work properly when remote control unit operated.	<ul style="list-style-type: none"> <li>Batteries are worn.</li> <li>You are operating outside of the specified range.</li> <li>Obstacle between main unit and remote control unit.</li> <li>The batteries are not inserted in the proper direction, as indicated by the polarity marks in the battery compartment.</li> <li>The set's remote control sensor is exposed to strong light (direct sunlight, inverter type fluorescent bulb light, etc.).</li> <li>The remote ID of the main unit and remote control unit do not match.</li> <li>The <b>SOURCE CONTROL</b> switches are not set in the correct positions.</li> </ul>	<ul style="list-style-type: none"> <li>Replace with new batteries.</li> </ul>	3
		<ul style="list-style-type: none"> <li>Operate within the specified range.</li> </ul>	3
		<ul style="list-style-type: none"> <li>Remove the obstacle.</li> </ul>	3
		<ul style="list-style-type: none"> <li>Insert the batteries in the proper direction, following the polarity marks in the battery compartment.</li> </ul>	3
		<ul style="list-style-type: none"> <li>Move the set to a place in which the remote control sensor will not be exposed to strong light.</li> </ul>	3
		<ul style="list-style-type: none"> <li>Set "Remote ID" for the main unit to "1".</li> </ul>	26
		<ul style="list-style-type: none"> <li>Set the <b>SOURCE CONTROL</b> switches to the correct positions according the operation you are applying.</li> </ul>	36 ~ 38, 42 ~ 44

**[Audio]**

Symptom	Cause	Countermeasure	Page
No sound is produced from center speaker.	<ul style="list-style-type: none"> <li>You are playing a monaural source (TV, AM radio broadcast, etc.) in the "STANDARD" (Dolby/DTS Surround) mode.</li> </ul>	<ul style="list-style-type: none"> <li>The mode is set to something other than "STANDARD" (Dolby/DTS Surround).</li> </ul>	27
No sound is produced from surround speakers.	<ul style="list-style-type: none"> <li>The surround mode is set to "STEREO" or "DIRECT".</li> </ul>	<ul style="list-style-type: none"> <li>Set to a surround playback mode.</li> </ul>	28
No sound is produced from subwoofer.	<ul style="list-style-type: none"> <li>Subwoofer's power not turned on.</li> <li>The "Subwoofer" setting at "Speaker Setup" is set to "No".</li> <li>The subwoofer is not properly connected.</li> <li>The subwoofer's volume is turned off.</li> </ul>	<ul style="list-style-type: none"> <li>Turn on the subwoofer's power.</li> </ul>	-
		<ul style="list-style-type: none"> <li>Set to "Yes".</li> </ul>	21
		<ul style="list-style-type: none"> <li>Check the connections.</li> </ul>	9
		<ul style="list-style-type: none"> <li>Adjust the subwoofer's volume to an appropriate level.</li> </ul>	40
No test tones are produced when remote control unit's <b>TEST</b> button is pressed.	<ul style="list-style-type: none"> <li>Surround mode not set to "STANDARD" (Dolby/DTS Surround).</li> </ul>	<ul style="list-style-type: none"> <li>Set to the "STANDARD" (Dolby/DTS Surround) mode.</li> </ul>	27
DTS sound is not output.	<ul style="list-style-type: none"> <li>DVD player's audio output setting is not set to bitstream.</li> <li>DVD player is not compatible with DTS sound playback.</li> <li>The AVR-589's "Input Mode" setting is set to other than "DTS".</li> </ul>	<ul style="list-style-type: none"> <li>Set the DVD player. For details, refer to the DVD player's operating instructions.</li> </ul>	-
		<ul style="list-style-type: none"> <li>Use a DTS-compatible player.</li> </ul>	-
		<ul style="list-style-type: none"> <li>Set to the "Auto" or "DTS" mode.</li> </ul>	34

**[Video]**

Symptom	Cause	Countermeasure	Page
No picture appears.	<ul style="list-style-type: none"> <li>The connections between the AVR-589 and monitor are faulty.</li> <li>The connection terminal of the AVR-589 and the connection terminal of the monitor are not of the same type.</li> </ul>	<ul style="list-style-type: none"> <li>Check the connections.</li> </ul>	10 ~ 13
		<ul style="list-style-type: none"> <li>Because video signals are output from the AVR-589's monitor output terminal in the same format as the video input signals, the monitor output terminal should be of the same type as the terminal used for input.</li> </ul>	-
			-
DVDs cannot be copied on a VCR.	-	<ul style="list-style-type: none"> <li>This is not a malfunction. Most movie software includes copy prevention signals and cannot be copied.</li> </ul>	-

**[HDMI]**

Symptom	Cause	Countermeasure	Page
HDMI audio signals are not output from speakers.	-	<ul style="list-style-type: none"> <li>The audio signal input to the HDMI input connector cannot be played on the AVR-589. Input the audio signal to the digital audio input connector or analog audio input connector.</li> </ul>	10
No picture appears with HDMI connections.	<ul style="list-style-type: none"> <li>The connections to the HDMI connectors are faulty.</li> <li>HDMI input setting is improper.</li> <li>The HDMI format of the player and monitor do not match.</li> </ul>	<ul style="list-style-type: none"> <li>Check the connections.</li> </ul>	10
		<ul style="list-style-type: none"> <li>Check the HDMI input setting.</li> <li>Match the HDMI format of the player and monitor.</li> </ul>	23 10
No sound is output from the monitor connected with HDMI connections.	<ul style="list-style-type: none"> <li>HDMI input setting is improper.</li> </ul>	<ul style="list-style-type: none"> <li>Check the HDMI input setting.</li> </ul>	23

**[iPod]**

Symptom	Cause	Countermeasure	Page
iPod cannot be played.	<ul style="list-style-type: none"> <li>The input source assigned to control dock for iPod is not selected.</li> <li>Cable is not properly connected.</li> <li>Control dock for iPod's AC adapter is not connected to power outlet.</li> </ul>	<ul style="list-style-type: none"> <li>Switch to the input source assigned at control dock for iPod.</li> </ul>	24
		<ul style="list-style-type: none"> <li>Reconnect.</li> </ul>	12
		<ul style="list-style-type: none"> <li>Plug the control dock for iPod's AC adapter into a power outlet.</li> </ul>	-

[SIRIUS Satellite Radio]

Symptom	Cause	Countermeasure	Page
"CHECK SR TUNER" is displayed in the SIRIUS mode.	• The Sirius Tuner unit is not connected.	• Check that the connections are correct.	14
"ANTENNA ERROR" is displayed in the SIRIUS mode.	• If the Sirius Tuner is not connected, it will be broken.	• Check that the connections are correct.	14
"NO SIGNAL" is displayed in the SIRIUS mode.	• The signal cannot be received.	• Reposition your SiriusConnect Home Tuner antenna.	37
"INVALID CHANNEL" is displayed in the SIRIUS mode.	• Channel is not present.	• Select another channel.	37
"NO CH AVAILABLE" is displayed in the SIRIUS mode.	• Even searching categories, if none of the channels are present, the "Parental Lock" is on (locked).	• Please search for other categories.	37
"ACQUIRING" is displayed in the SIRIUS mode.	• The selected channel is not currently broadcasting. • Displays while SiriusConnect Home Tuner is connected.	• Select another channel.	37
"Call SIRIUS" * is displayed in the SIRIUS mode.	• Channels are not subscribed to.	• If you subscribe to the channel, you can receive the channel.	-
"SUB UPDATED" is displayed in the SIRIUS mode.	• While updating contract information.	-	-
"Code? [ ]" is displayed in the SIRIUS mode.	• Selected channels are locked.	• Please insert pass word (4 digits) into "[ ]":	25

\* : After scroll displays "Call 888-539-...." twice, displays "Call SIRIUS".

# Specifications

## Audio section

- **Power amplifier**  
**Rated output:**

Front (A, B):  
75 W + 75 W (8 Ω/ohms, 20 Hz ~ 20 kHz with 0.08 % T.H.D.)  
110 W + 110 W (6 Ω/ohms, 1 kHz with 0.7 % T.H.D.)

Center:  
75 W (8 Ω/ohms, 20 Hz ~ 20 kHz with 0.08 % T.H.D.)  
110 W (6 Ω/ohms, 1 kHz with 0.7 % T.H.D.)

Surround:  
75 W + 75 W (8 Ω/ohms, 20 Hz ~ 20 kHz with 0.08 % T.H.D.)  
110 W + 110 W (6 Ω/ohms, 1 kHz with 0.7 % T.H.D.)

Front: A or B 6 ~ 16 Ω/ohms  
A + B 12 ~ 16 Ω/ohms  
Center, Surround: 6 ~ 16 Ω/ohms

### Output connectors:

- **Analog**

**Input sensitivity / Input impedance:** 200 mV / 47 kΩ/kohms  
**Frequency response:** 10 Hz ~ 100 kHz — +1, -3 dB (DIRECT mode)  
**S/N:** 98 dB (IHF-A weighted, DIRECT mode)

## Video section

- **Standard video connectors**

**Input / output level and impedance:** 1 Vp-p, 75 Ω/ohms  
**Frequency response:** 5 Hz ~ 10 MHz — +1, -3 dB

- **S-Video connectors**

**Input / output level and impedance:** Y (brightness) signal — 1 Vp-p, 75 Ω/ohms  
C (color) signal — 0.286 Vp-p, 75 Ω/ohms  
**Frequency response:** 5 Hz ~ 10 MHz — +1, -3 dB

- **Color component video connectors**

**Input / output level and impedance:** Y (brightness) signal — 1 Vp-p, 75 Ω/ohms  
P<sub>B</sub> / C<sub>B</sub> signal — 0.7 Vp-p, 75 Ω/ohms  
P<sub>R</sub> / C<sub>R</sub> signal — 0.7 Vp-p, 75 Ω/ohms  
**Frequency response:** 5 Hz ~ 30 MHz — +0, -3 dB

## Tuner section

**Receiving Range:** 87.5 MHz ~ 107.9 MHz  
**Usable Sensitivity:** 1.0 μV (11.2 dBf)  
**50 dB Quieting Sensitivity:** MONO 1.6 μV (15.3 dBf)  
STEREO 23 μV (38.5 dBf)

**S/N (IHF-A):** MONO 77 dB  
STEREO 72 dB

**Total harmonic Distortion (at 1 kHz):** MONO 0.15 %  
STEREO 0.3 %

[FM]	[AM]
(note: μV at 75 Ω/ohms, 0 dBf = 1 x 10 <sup>-15</sup> W)	
875 MHz ~ 1079 MHz	520 kHz ~ 1710 kHz
1.0 μV (11.2 dBf)	18 μV

## General

**Power supply:** AC 120 V, 60 Hz  
**Power consumption:** 3.9 A  
0.3 W (Standby)

**Maximum external dimensions:** 434 (W) x 171 (H) x 377 (D) mm (17-3/32" x 6-47/64" x 14-27/32")  
**Weight:** 10.8 kg (23 lbs 13 oz)

## Remote control unit (RC-1104)

**Batteries:** R6/AA Type (two batteries)  
**Maximum external dimensions:** 52 (W) x 243 (H) x 21 (D) mm (2-3/64" x 9-9/16" x 53/64")  
**Weight:** 184 g (Approx. 6.5 oz) (including batteries)

\* For purposes of improvement, specifications and design are subject to change without notice.

## List of preset codes / Liste de codes pré-réglés

### Blu-Ray Disc Player / DVD Player

<b>A</b>	Aiwa	009
<b>D</b>	Denon	014, [111]*, 121
<b>H</b>	Hitachi	010
<b>J</b>	JVC	006, 011
<b>K</b>	Konka	012, 013
<b>M</b>	Magnavox	005
	Mitsubishi	004
<b>P</b>	Panasonic	014
	Philips	005, 015, 016, 017
	Pioneer	003, 008
<b>S</b>	Sanyo	018
	Sony	002, 019, 020
<b>T</b>	Toshiba	001, 021, 022
<b>Z</b>	Zenith	023

### VDP

<b>D</b>	Denon	028, 029, 112
<b>M</b>	Magnavox	026
	Mitsubishi	028
<b>P</b>	Panasonic	029, 030
	Philips	026
	Pioneer	028, 031
<b>R</b>	RCA	032
<b>S</b>	Sony	033, 034, 035, 036

### VCR

<b>A</b>	Admiral	081
	Aiko	095
	Aiwa	009
	Akai	026, 027, 070, 072, 082, 083, 084
	Alba	055
	Amstrad	009
	ASA	042
	Asha	087
	Audio Dynamic	005, 085
	Audiovox	088
	Beaumarck	087
	Broksonic	086, 093
<b>C</b>	Calix	088
	Candle	006, 087, 088, 089, 090
	Canon	049, 057
	Capehart	025, 055, 056, 071
	Carver	015
	CCE	095
	Citizen	006, 007, 087, 088, 089, 090, 095
	Craig	007, 087, 088, 091, 115

	Curtis Mathes	006, 049, 073, 080, 087, 090, 092
	Cybernex	087
<b>D</b>	Daewoo	025, 055, 059, 074, 089, 093, 095, 096
	Daytron	025, 055
	DBX	005, 085
	Dumont	053
	Dynatech	009
<b>E</b>	Electrohome	001, 088, 097
	Electroponic	088
	Emerson	001, 009, 017, 027, 086, 088, 089, 092, 093, 097, 100, 101, 102, 103, 104, 117
<b>F</b>	Fisher	009, 028, 031, 053, 054, 091, 099, 115
<b>G</b>	GE	007, 011, 049, 050, 051, 052, 073, 080, 087
	Go Video	047, 048
	Goldstar	000, 006, 012, 062, 088
	Gradiente	094
	Grundig	042
<b>H</b>	Harley Davidson	094
	Harman Kardon	040, 062
	Hi-Q	091
	Hitachi	009, 013, 023, 026, 058, [108]*, 109, 110, 111
<b>J</b>	JC Penny	004, 005, 007, 023, 028, 049, 062, 085, 087, 088
	Jensen	013, 026
	JVC	004, 005, 006, 026, 029, 043, 044, 045, 046, 085
<b>K</b>	Kenwood	004, 005, 006, 026, 029, 033, 045, 085, 090
	Kodak	088
<b>L</b>	Lloyd	009, 094
	LXI	088
<b>M</b>	Magnavox	015, 016, 042, 049, 063, 106
	Magnin	087
	Marantz	004, 005, 006, 015, 042, 049, 085, 090
	Marta	088
	MEI	049
	Memorex	009, 033, 049, 053, 060, 081, 087, 088, 091, 094, 115
	Metz	123, 124, 125, 126, 127, 128
	MGA	001, 017, 027, 041, 097
	MGN Technology	087
	Midland	011
	Minolta	013, 023
	Mitsubishi	001, 003, 008, 013, 014, 017, 027, 029, 039, 040, 041, 045, 097
	Motorola	081
	Montgomery Ward	001, 002, 007, 009, 049, 063, 081, 115, 117
	MTC	009, 087, 094

	Multitech	007, 009, 011, 087, 090, 094
<b>N</b>	NAD	038
	NEC	004, 005, 006, 018, 026, 029, 045, 061, 062, 085
	Nikko	088
	Noblex	087
<b>O</b>	Optimus	081, 088
	Optonica	021
<b>P</b>	Panasonic	024, 049, 064, 066, 067, 068, 069, 107
	Perdio	009
	Pentax	009, 013, 023, 058, 090
	Philco	015, 016, 049
	Philips	015, 021, 042, 049, 105
	Pilot	088
	Pioneer	005, 013, 029, 036, 037, 038, 045, 085
	Portland	025, 055, 090
	Proscan	063, 080
	Pulsar	060
<b>Q</b>	Quartz	033
	Quasar	034, 035, 049
<b>R</b>	Radio Shack	001, 002, 021, 081, 087, 088, 091, 094, 097, 098, 115
	Radix	088
	Randex	088
	RCA	007, 013, 019, 023, 058, 063, 064, 065, 073, 080, 082, 087, 089, 021, 031, 033, 049, 053, 081, 087, 088, 091, 094, 097, 098
	Realistic	055
<b>S</b>	Salora	033, 041
	Samsung	007, 011, 051, 059, 070, 083, 087, 089, 113
	Sanky	081
	Sansui	005, 026, 029, 045, 061, 085, 114
	Sanyo	032, 033, 053, 087, 091, 115, 116
	SBR	042
	Scott	017, 020, 086, 089, 093, 117
	Sears	013, 023, 028, 031, 033, 053, 054, 088, 091, 098, 099, 115
	Sentra	055
	Sharp	001, 002, 021, 097
	Shogun	087
	Sony	075, 076, 077, 078, 079, 121, 122
	STS	023
	Sylvania	009, 015, 016, 017, 041, 049, 094
	Symphonic	009, 094
<b>T</b>	Tandy	009
	Tashiko	009, 088
	Tatung	004, 026, 030

	Teac	004, 009, 026, 094
	Technics	024, 049
	TMK	087, 092
	Toshiba	013, 017, 020, 041, 059, 089, 098, 099, 117
	Totevision	007, 087, 088
<b>U</b>	Unirech	087
<b>V</b>	Vectror Research	005, 062, 085, 089, 090
	Victor	005, 045, 046, 085
	Video Concepts	005, 027, 085, 089, 090
	Videosonic	007, 087
<b>W</b>	Wards	013, 021, 023, 087, 088, 089, 091, 094, 097, 118, 119, 120
<b>X</b>	XR-1000	094
<b>Y</b>	Yamaha	004, 005, 006, 026, 062, 085
<b>Z</b>	Zenith	060, 078, 079

### Television

<b>A</b>	Admiral	045, 121
	Adventura	122
	Aiko	054
	Akai	016, 027, 046
	Alleron	062
	A-Mark	007
	Amtron	061
	Anam	006, 007, 036
	Anam National	061, 147
	AOC	003, 007, 033, 038, 039, 047, 048, 049, 133
	Archer	007
	Audiovox	007, 061
<b>B</b>	Bauer	155
	Belcor	047
	Bell & Howell	045, 118
	Bradford	061
	Brockwood	003, 047
<b>C</b>	Candle	003, 030, 031, 032, 038, 047, 049, 050, 122
	Capehart	003
	Celebrity	046
	Circuit City	003
	Citizen	029, 030, 031, 032, 034, 038, 047, 049, 050, 054, 061, 095, 122, 123
	Concerto	031, 047, 049
	Colortyme	003, 047, 049, 135
	Contec	013, 051, 052, 061
	Cony	051, 052, 061
	Craig	004, 061
	Crown	029
	Curtis Mathes	029, 034, 038, 044, 047, 049, 053, 095, 118

<b>D</b>	Daewoo	027, 029, 039, 048, 049, 054, 055, 106, 107, 137
	Daytron	003, 049
	Dimensia	044
	Dixi	007, 015, 027
<b>E</b>	Electroband	046
	Electrohome	029, 056, 057, 058, 147
	Elta	027
	Emerson	029, 051, 059, 060, 061, 062, 118, 123, 124, 139, 148
	Envision	038
	Etron	027
<b>F</b>	Fisher	014, 021, 063, 064, 065, 118
	Formenti	155
	Fortress	012
	Fujitsu	004, 062
	Funai	004, 062
	Futuretech	004
<b>G</b>	GE	020, 036, 037, 040, 044, 058, 066, 088, 119, 120, 125, 147
	Goldstar	000, 015, 029, 031, 039, 048, 051, 056, 057, 067, 068, 069, 116
	Grundy	062
<b>H</b>	Hitachi	029, 031, 051, 052, 070, 111, 112, 113, 124, [134]*
	Hitachi Pay TV	151
<b>I</b>	Infinity	017, 071
<b>J</b>	Janeil	122
	JBL	017, 071
	JC Penny	020, 034, 039, 040, 041, 044, 048, 050, 058, 066, 069, 076, 088, 090, 095, 125, 136, 159
	JCB	046
	JVC	019, 051, 052, 072, 073, 091, 117, 126
<b>K</b>	Kawasho	018, 046
	Kenwood	038, 056, 057
	Kloss	010, 032
	Kloss Novabeam	005, 122, 127, 131
	KTV	074, 123
<b>L</b>	Loewe	071
	logik	144
	Luxman	031
	LXI	008, 014, 017, 024, 040, 044, 063, 071, 075, 076, 077, 118, 125
<b>M</b>	Magnavox	005, 010, 017, 030, 033, 038, 050, 056, 071, 078, 079, 085, 089, 108, 109, 110, 127, 131, 132, 145
	Marantz	015, 017, 071, 080
	Matsui	027
	Memorex	014, 027, 045, 083, 118, 144
	Metz	160, 161, 162, 163

MGA	001, 039, 048, 056, 057, 058, 065, 081, 083
Midland	125
Minutz	066
Mitsubishi	001, 016, 039, 048, 056, 057, 058, 065, 081, 082, 083, 105
Montgomery Ward	011, 020, 144, 145, 146
Motorola	121, 147
MTC	031, 034, 039, 048, 095
NAD	008, 075, 076, 128
National	002, 036, 061, 147
National Quenties	002
NEC	031, 038, 039, 048, 057, 084, 086, 135, 147
Nikko	054
NTC	054
Optimus	128
Optonica	011, 012, 093, 121
Orion	004, 139
Panasonic	002, 009, 017, 036, 037, 071, 141, 143, 147
Philco	005, 010, 030, 050, 051, 056, 079, 085, 127, 131, 132, 145, 147
Philips	005, 015, 017, 050, 051, 056, 078, 087, 088, 089, 131, 132, 147
Pioneer	124, 128, 142
Portland	054
Price Club	095
Proscan	040, 044, 125
Proton	035, 051, 092, 129
Pulsar	042
Quasar	036, 037, 074, 141
Radio Shack	011, 044, 063, 093, 118
RCA	040, 044, 125, 130, 137, 151, 152
Realistic	014, 063, 093, 118
Saisho	027
Samsung	003, 015, 034, 053, 055, 057, 094, 095, 136, 153
Sansui	139
Sanyo	013, 014, 021, 022, 063, 064, 081, 096
SBR	015
Schneider	015
Scott	062
Sears	008, 014, 021, 022, 023, 024, 025, 040, 052, 057, 062, 063, 064, 065, 073, 075, 076, 097, 098, 125, 159
Sharp	011, 012, 013, 026, 093, 099, 100, 104, 121
Siemens	013
Signature	045, 144
Simpson	050
Sony	043, 046, 138, 146, 150
Soundesign	030, 050, 062
Spectricon	007, 033

Squareview	004
Supre-Macy	032, 122
Supreme	046
Sylvania	005, 010, 017, 030, 078, 079, 085, 089, 101, 127, 131, 132, 145, 155
Symphonic	004, 148
Tandy	012, 121
Tatung	036, 124
Technics	037
Teknika	001, 030, 032, 034, 052, 054, 078, 083, 095, 144, 156, 157
Tera	035, 129
THOMSON	165, 166
Toshiba	008, 014, 034, 063, 075, 076, 095, 097, 136, 158, 159
Universal	020, 066, 088
Victor	019, 073, 126
Video Concepts	016
Viking	032, 122
Wards	005, 045, 066, 078, 085, 088, 089, 093, 102, 103, 131, 132, 148
Zenith	042, 114, 115, 140, 144, 149
Zonda	007

## Cable

ABC	006, [007]*, 008, 009
Archer	010, 011
Century	011
Citizen	011
Colour Voice	012, 013
Comtronic	014
Eastern	015
Garrard	011
Gemini	030, 033, 034
General Instrument	030, 031, 032
Hytex	006
Jasco	011
Jerrold	009, 016, 017, 026, 032
Magnavox	018
Movie Time	019
NSC	019
Oak	000, 006, 020
Panasonic	001, 005
Philips	011, 012, 013, 018, 021
Pioneer	002, 003, 022
RCA	029
Regency	015
Samsung	014, 023
Scientific Atlanta	004, 024, 025
Signal	014
SL Marx	014
Starcom	009

Stargate	014
Teleview	014
Tocom	007, 016
TV86	019
Unika	011
United Artists	006
Universal	010, 011
Viewstar	018, 019
Zenith	027, 028

## Satellite Receiver

Alphastar	054
Chaparrali	035, 036
Dishnet	053
Drake	037, 038
Echostar Dish	062, 066
GE	048, 055, 056
General Instruments	039, 040, 041
Grundig	070, 071, 072, 073
Hitachi	058, 059
Hughes Networkr	063, 064, 065, 069
JVC	057
Kathrein	074, 075, 076, 083
Magnavoxl	060
Nokia	070, 080, 084, 085, 086
Philips	060
Primestar	051
Proscan	048, 055, 056
RCA	048, 055, 056, 068
Realistic	042
Sierra I	036
Sierra II	036
Sierra III	036
Sony	049, 067
STS1	043
STS2	044
STS3	045
SRS4	046
Technisat	077, 078, 079, 081, 082
Toshiba	047, 050
Uniden	061

## CD Player

Aiwa	001, 035, 043
Burmster	002
Carvery	003, 035
Denon	[111]*, 044
Emerson	004, 005, 006, 007
Fisher	003, 008, 009, 010
JVC	018, 019

Kenwood	011, 012, 013, 014, 017
Magnavox	006, 015, 035
Marantz	016, 028, 035
MCS	016, 024
Ornkyo	025, 027
Optimus	017, 020, 021, 022, 023
Philips	014, 032, 033, 035
Pioneer	006, 022, 030
Sears	006
Sony	023, 031
Teac	002, 009, 028
Technics	016, 029, 036
Wards	035, 037
Yamaha	038, 039, 040, 041
Zenith	042

## DVD preset codes / Codes pré-réglés DVD

	111 (default / défaut)	014	
DENON Model No. / Modèle numéro	DVD-555	DVD-2910	DVD-800
	DVD-556	DVD-2930CI	DVD-1600
	DVD-557	DVD-3800	DVD-2000
	DVD-558	DVD-3910	DVD-2500
	DVD-755	DVD-3930CI	DVD-3000
	DVD-756	DVD-5900	DVD-3300
	DVD-757	DVD-5910CI	
	DVD-758	DVD-9000	
	DVD-900	DVD-2500BT	
	DVD-910	DVD-3800BD	
	DVD-955	DVM-715	
	DVD-1000	DVM-735	
	DVD-1200	DVM-745	
	DVD-1500	DVM-1800	
	DVD-1710	DVM-1805	
	DVD-1720	DVM-1815	
	DVD-1730	DVM-1835	
	DVD-1910	DVM-1845	
DVD-1920	DVM-2815		
DVD-1930CI	DVM-2845		
DVD-1940CI	DVM-4800		
DVD-2200			
DVD-2800			
DVD-2800II			
DVD-2900			

[ ]\*: Preset codes set upon shipment from the factory.

: Les codes pré-réglés diffèrent en fonction des livraisons de l'usine.

**DENON**

[www.denon.com](http://www.denon.com)

Denon Brand Company, D&M Holdings Inc.  
Printed in China 5411 10042 006D

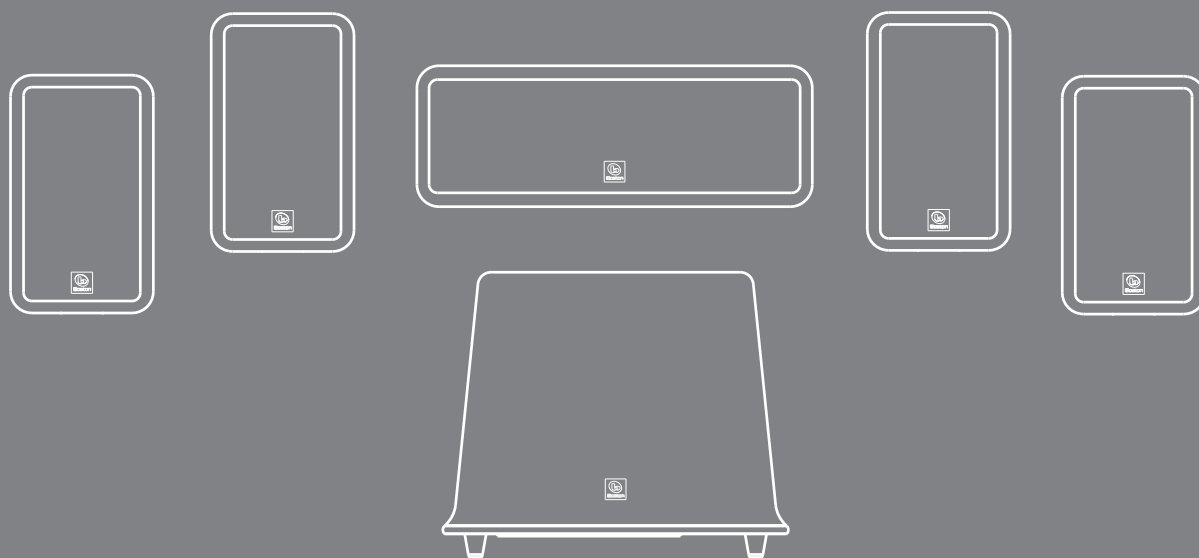

---

# HORIZON MCS 90

## 5.1 Surround Speaker System

---

### Español

MCS 90

Sistema Multicanal Boston

### Français

MCS 90

Haut-parleur multivoix Boston



## Important Safety Instructions



This symbol found on the apparatus indicates hazards arising from dangerous voltages.



This symbol found on the apparatus indicates the user should read all safety statements found in the user manual.



This symbol found on the apparatus indicates double insulation.



**WARNING!** To reduce the risk of fire or electric shock, do not expose this apparatus to rain or moisture.



This symbol found on the apparatus indicates that the apparatus must be placed in a separate collection facility for electronic waste and not disposed of with household waste.

1. Read these instructions.
2. Keep these instructions.
3. Heed all warnings.
4. Follow all instructions.
5. Do not use this apparatus near water.
6. Clean only with dry cloth.
7. Do not block any ventilation openings. Install in accordance with the manufacturer's instructions.
8. Do not install near any heat sources such as radiators, heat registers, stoves, or other apparatus (including amplifiers) that produce heat.
9. Do not defeat the safety purpose of the polarized or grounding-type plug. A polarized plug has two blades with one wider than the other. A grounding type plug has two blades and a third grounding prong. The wide blade or the third prong are provided for your safety. If the provided plug does not fit into your outlet, consult an electrician for replacement of the obsolete outlet.
10. Protect the power cord from being walked on or pinched particularly at plugs, convenience receptacles, and the point where they exit from the apparatus.
11. Only use attachments/accessories specified by the manufacturer.
12. Unplug this apparatus during lightning storms or when unused for long periods of time.
13. Refer all servicing to qualified service personnel. Servicing is required when the apparatus has been damaged in any way, such as power supply cord or plug is damaged, liquid has been spilled or objects have fallen into the apparatus, the apparatus has been exposed to rain or moisture, does not operate normally, or has been dropped.
14. Maintain a minimum distance of 50 mm around the front, rear and sides of the apparatus for sufficient ventilation. The ventilation should not be impeded by covering the ventilation openings or placing on or around the apparatus items such as newspapers, table-cloths, curtains, etc.
15. No naked flame sources, such as lighted candles, should be placed on the apparatus.
16. The apparatus shall not be exposed to dripping or splashing. No objects filled with liquids, such as vases, shall be placed on the apparatus.
17. Either the power inlet connector on the rear of the apparatus or the power plug at the wall must remain accessible, to be able to disconnect power from the apparatus.
18. To completely disconnect this apparatus from the AC Mains, disconnect the power supply cord plug from the AC receptacle.
19. The mains plug of the power supply cord shall remain readily operable.

<b>Specifications</b>	<b>Satellites</b>	<b>Center Channel</b>	<b>Subwoofer</b>
<b>Frequency Response:</b>	120Hz – 20kHz	120Hz – 20kHz	40 - 180Hz
<b>Recommended Amplifier Power Range:</b>	10 – 100 watts	10 – 100 watts	—
<b>Sensitivity:</b>	88dB [2.8v at 1m]	88dB [2.8v at 1m]	—
<b>Nominal Impedance:</b>	8 ohms	8 ohms	—
<b>Crossover Frequency:</b>	3,000Hz	3,000Hz	—
<b>Amplifier Output:</b>	—	—	100 watts RMS
<b>Woofers:</b>	3" with Phase Plugs & MagnaGuard®	3" with Phase Plugs & MagnaGuard	8"
<b>Tweeter:</b>	½" (13mm)	½" (13mm)	—
<b>Dimensions (H x W x D)</b>	7¾ x 4¾ x 4¹¹⁄₁₆" (189 x 113 x 93mm)	5¹¹⁄₁₆ x 12¾ x 3¾" (145 x 321 x 95mm)	12¾ x 15¾ x 15¾" (324 x 390 x 390mm)
<b>Weight</b>	2.5 lbs (1.14kg)	4.6 lbs (2.1kg)	22.7 lbs (10.3kg)

## MCS 90 Introduction

Thank you for purchasing a Boston Acoustics Multi-Channel Speaker System. These speakers incorporate high-quality components that produce the famous Boston sound. The system is ideally suited for use as a 5.1 channel solution in a high-quality home theater or music system. The system is complete with everything you need for the typical speaker system including speaker wire, satellite speakers, a center channel speaker, and a subwoofer. Please check out [Bostonacoustics.com/placement](http://Bostonacoustics.com/placement) for information on placing your speakers.

The MCS 90 speaker system delivers exceptionally articulate on-screen dialog, music, effects, and room filling bass from a small, sleek package. Compact driver placement and quality, system specific crossovers assure a wide uniform dispersion for complete coverage of a listening room. All speakers also feature MagnaGuard® magnetic shielding which ensures the speaker's magnetic field does not interfere with the television's picture.

## Unpacking the System

Carefully unpack the system. If there is any sign of damage from transit, report it immediately to your dealer and/or delivery service. Keep the shipping carton and packing materials for future use. Open the package and verify the following contents:

- (4) Satellite speakers**
- (1) Center Channel speaker**
- (1) Subwoofer**
- (2) 40' (12m) speaker wires**
- (3) 15' (4.6m) speaker wires**
- (1) 15' (4.6m) subwoofer cable**
- (8) Rubber bumpers (used for wall mounting)**

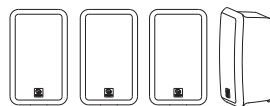

**(4) Satellite speakers with 1 removable foot**

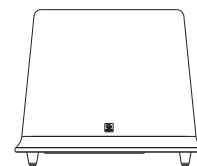

**Subwoofer**

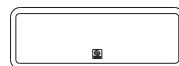

**(1) Center Channel speaker with 2 removable feet**

## Placement Options

The MCS 90 satellites and center channel are easily placed on a tabletop or wall-mounted. The speakers are configured for tabletop use when you first unpack the system. The foot installed on the rear of the speaker will keep it upright.

The MCS 90 satellites and center channel are designed to easily mount on the wall using the keyhole slot(s) on the back of the speaker. When mounting the speakers to the wall use the supplied rubber bumpers. You must remove the attached foot to wall-mount your speakers. Remove the thumbscrew from the back of the foot. It is slotted for easy removal with a screwdriver or a coin.

The keyhole mounting option is similar to hanging a picture frame on a wall. Install a #8 screw (not included) into the sheetrock, making sure to go into a stud, and hang the speaker onto the screw head. If a stud is not available, a sheetrock anchor should be used to support the weight of the speaker. It is advisable to connect the speaker wire prior to wall-mounting.

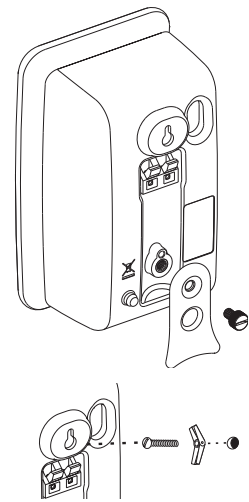

**NOTE:** Because there are so many different kinds of surfaces on which the speakers could be mounted. There is no one type of fastener that we could supply that would work in all the possible situations. So taking into account the surface the speaker is being mounted on, acquire the appropriate type of fasteners. If you're not sure what type of fastener to use, take the mounting bracket to a friendly hardware store, tell them about the wall you're mounting the speaker on, and ask them to recommend an appropriate fastener. Keep in mind the weight of the speaker.

## Speaker Connections

After your speakers are properly placed, you are ready to wire your system. First, turn off all system power. Use the speaker wire included with the system to make your connections. For longer distances, #16 or #18 gauge wire available from your dealer should be used. Please see the illustration for guidance connecting the wires to the MCS 90 satellites and center channel.

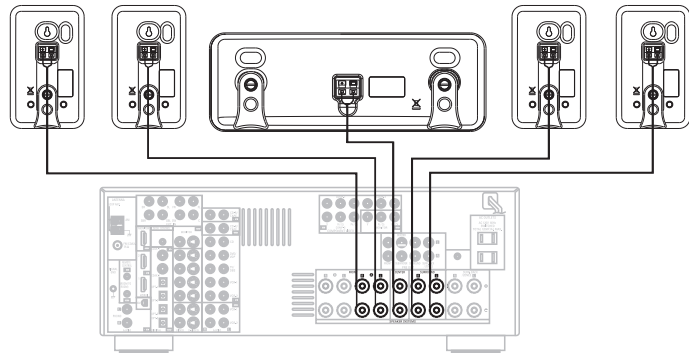

For connection to your receiver please refer to its owner's manual.

## Important!

To ensure the best performance observe polarities when making speaker connections, as shown in the illustration. Connect each + terminal on the back of the amplifier or receiver to the respective + (red) terminal on each speaker. Connect the - (black) terminals in the same way. If the connections are not made correctly it can cause poor bass response and imaging. Also, to avoid short circuits that may damage your equipment be careful not to let any of the bare wires touch each other.

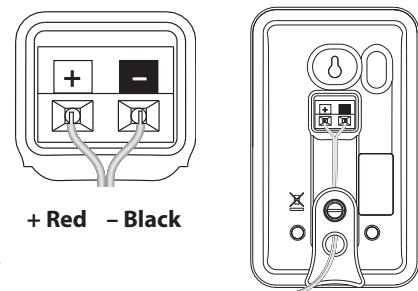

## Subwoofer Connections

Turn off all power. Use the subwoofer cable included with your system to connect the subwoofer to your receiver's Subwoofer or LFE Output. Connect the other end to the "Line In" on the back of the Subwoofer.

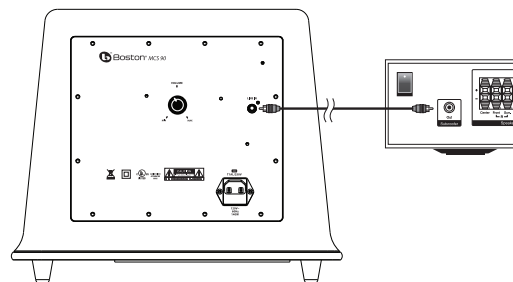

## Subwoofer Controls

### Power On

Plug the subwoofer's AC cord into a wall outlet. We do not recommend using the outlets on the back of the receiver. The subwoofer features auto on/standby. An LED indicator next to the volume control indicates what mode the subwoofer is in.

RED = STANDBY (No signal detected, Amp Off)

GREEN = ON (Signal detected, Amp On)

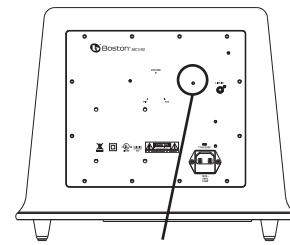

LED indicator

The subwoofer will automatically enter the Standby mode after several minutes when no signal is detected from your system. The subwoofer will then power ON instantly when a signal is detected.

### Volume Control

Begin by adjusting the Subwoofer Volume Control to the 11 o'clock position. Further adjust the Subwoofer Volume Control until you hear a match in volume between the main speakers and subwoofer. Ideally, bass response should not overpower the room but rather be adjusted so there is a natural blend across the entire musical range.

## Operation

When using the MCS 90 in a Dolby® Digital or DTS™ home theater system, make sure all speakers are set to "Small". When using the system in a Dolby Pro Logic® home theater system, make sure the receiver's center channel mode is set to "Normal."

Some Dolby Digital equipped receivers/processors offer different setup options for each source or surround mode (e.g., CD-stereo, videotape, Dolby Digital, Pro Logic®). In each case, follow your equipment's instructions to ensure that the subwoofer output is turned on and that the speakers are set to "Small" in each mode.

**If your receiver has adjustable crossover settings, we recommend the subwoofer crossover be set at 150Hz.**

Refer to the owner's manual for your AV receiver for any additional recommendations on system operation.

## Maintenance and Service

The satellite and subwoofer enclosures may be cleaned using a soft cloth to remove fingerprints or to wipe off dust. All wiring connections should be inspected and cleaned or remade at least once a year.

If a problem does occur, make sure that all connections are properly made, secure and clean. If a problem occurs in one loudspeaker, rewire that speaker in a different location within the system. Should the problem persist in this speaker the problem is within the speaker. If the speaker sounds fine in the new position it is a strong indication of a more in depth issue with the electronics in the system. In the event that your MCS 90 ever needs service, contact your local Boston Acoustics dealer or visit [www.Bostona.com](http://www.Bostona.com) for a list of dealers in your area.

If your subwoofer does not play, check that all the connectors on the cables are making proper contact and that the AC plug is connected to a "live" receptacle.

## Limited Warranty

Boston Acoustics warrants to the original purchaser of our MCS 90 system that it will be free of defects in materials and workmanship in its mechanical parts for a period of 5 years from the date of purchase. The warranty period for the electrical components of MCS 90 is 1 year.

Your responsibilities are to install and use them according to the instructions supplied, to provide safe and secure transportation to an authorized Boston Acoustics service representative, and to present proof of purchase in the form of your sales slip when requesting service.

Excluded from this warranty is damage that results from abuse, misuse, improper installation, accidents, shipping, or repairs/modifications by anyone other than an authorized Boston Acoustics service representative.

This warranty is limited to the Boston Acoustics product and does not cover damage to any associated equipment. This warranty does not cover the cost of removal or reinstallation. This warranty is void if the serial number has been removed or defaced. This warranty gives you specific legal rights, and you may also have other rights which vary from state to state.

## If Service Seems Necessary

First, contact the dealer from whom you purchased the product. If that is not possible, write to:

Boston Acoustics, Inc.  
300 Jubilee Drive  
Peabody, MA 01960 USA

Or contact us via e-mail at:  
[support@bostona.com](mailto:support@bostona.com)

We will promptly advise you of what action to take. If it is necessary to return your MCS 90 to the factory, please ship it prepaid. After it has been repaired, we will return it freight prepaid in the United States and Canada.



### For EU Customers Only

This symbol found on the product indicates that the product must not be disposed of with household waste. Instead, it may be placed in a separate collection facility for electronic waste or returned to a retailer when purchasing similar product. The producer paid to recycle this product. Doing this contributes to reuse and recycling, minimizes adverse effects on the environment and human health and avoids any fines for incorrect disposal.

Boston Acoustics continually strives to update and improve its products. The specifications and construction details are subject to change without notice.



300 Jubilee Drive, Peabody, MA 01960 USA  
[www.bostonacoustics.com](http://www.bostonacoustics.com)

Boston, Boston Acoustics, MagnaGuard, Kortec, and the Boston Acoustics logo are registered trademarks of Boston Acoustics, Inc. Dolby Digital, and Dolby Pro Logic are registered trademarks of Dolby Laboratories. DTS is a registered trademarks of DTS, Inc. Specifications are subject to change without notice. © 2008 Boston Acoustics, Inc. 142-003282-0