

KIT FEATURES

- ▶ Shaft and DIN unit provisions



99-3320 INSTALLATION INSTRUCTIONS

KIT COMPONENTS

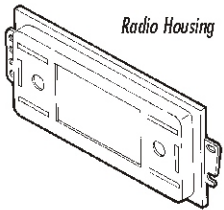

Radio Housing

- (1) Phillips Pan-head Screw

TOOLS REQUIRED



Phillips screwdriver



Cutting tool



Socket wrench

APPLICATIONS

CAR

PONTIAC

	PAGE
Bonneville 1994-99.....	1
Firebird 1993-02.....	2
Grand Am 1996-98.....	1
Grand Am 1999-00.....	1
Grand Prix 1994-96.....	1
Grand Prix 1997-03.....	2
Sunfire 1995-99.....	2
Trans Am 1993-02.....	2



1-800-221-0932 www.metraonline.com
 © COPYRIGHT 2001-07 METRA ELECTRONICS CORPORATION
 rev. 06-14-07

PONTIAC Bonneville 1994-99

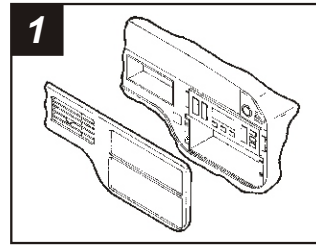

1 Disconnect the negative battery terminal to prevent an accidental short circuit. Unclip the right side of the dash trim bezel. Unclip the left side of the bezel and remove. Remove (3) 7mm hex-head screws securing the factory head unit and disconnect the wiring. Skip to the Installation Instructions for ALL VEHICLES on Page #2.

PONTIAC Grand Am 1996-98

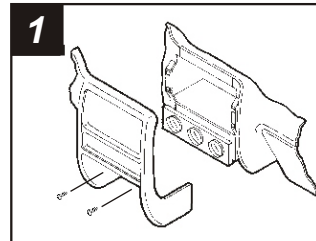

1 Disconnect the negative battery terminal to prevent an accidental short circuit. Remove (2) Phillips screws from the pocket. Remove (2) Phillips screws above the instrument cluster. Unclip the dash trim bezel and remove. Remove (3) 7mm hex-head screws securing the factory head unit and disconnect the wiring. Skip to the Installation Instructions for ALL VEHICLES on Page #2.

PONTIAC Grand Am 1999-00



1 Disconnect the negative battery terminal to prevent an accidental short circuit. Unclip the radio trim bezel. Remove (3) 9/32" screws securing the factory head unit and disconnect the wiring. Skip to the Installation Instructions for ALL VEHICLES on Page #2.

PONTIAC Grand Prix 1994-96

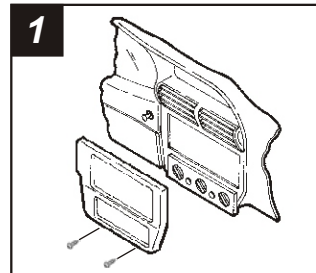

1 Disconnect the negative battery terminal to prevent an accidental short circuit. Using a small set of pliers, grasp the retaining clip on the back of the gear shifter handle and remove the clip. Remove the gear shifter handle. Unclip the center console and remove. Remove (2) 7mm hex-head screws exposed under the climate controls. Unclip the radio trim bezel and remove. Remove (2) 7mm hex-head screws securing the factory head unit and disconnect the wiring. Skip to the Installation Instructions for ALL VEHICLES on Page #2.

PONTIAC Grand Prix 1997-03

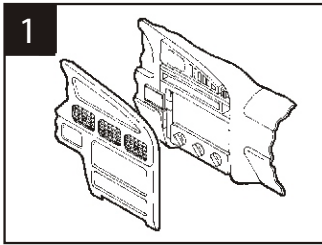

1 Disconnect the negative battery terminal to prevent an accidental short circuit. Unclip the entire dash trim bezel. Remove the screws securing the factory head unit and disconnect the wiring. Skip to the Installation Instructions for ALL VEHICLES on Page #2.

PONTIAC Sunfire 1995-99

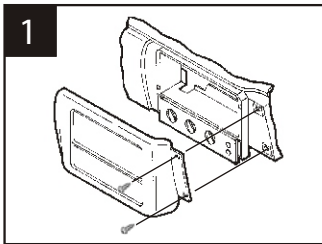

1 Disconnect the negative battery terminal to prevent an accidental short circuit. Open the glove box and remove (2) Phillips screws exposed on the right edge of the radio trim bezel. Unclip the bezel and remove. Remove (2) 7mm hex-head screws securing the factory head unit and disconnect the wiring. Skip to the Installation Instructions for ALL VEHICLES on Page #2.

PONTIAC Trans Am / Firebird 1993-02

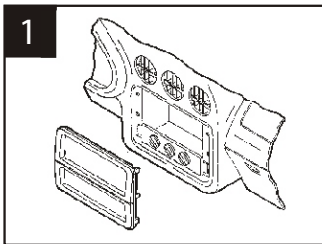

1 Disconnect the negative battery terminal to prevent an accidental short circuit. Unclip the radio trim bezel. Remove (4) 7mm hex-head screws securing the factory head unit and disconnect the wiring. Skip to the Installation Instructions for ALL VEHICLES on Page #2.

ALL VEHICLES

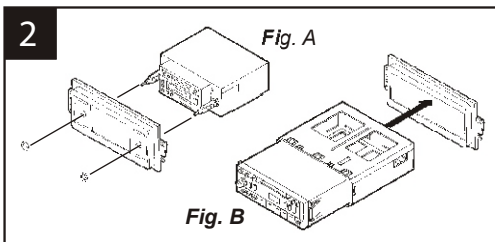

2-SHAFT HEAD UNITS: Slide the aftermarket head unit into the kit and secure with shaft nuts. (see Fig. A)

DIN HEAD UNITS: Cut and remove the shaft supports. Slide the DIN cage into the kit and secure by bending the metal locking tabs down. Slide the aftermarket head unit into the cage until secure. (see Fig. B)

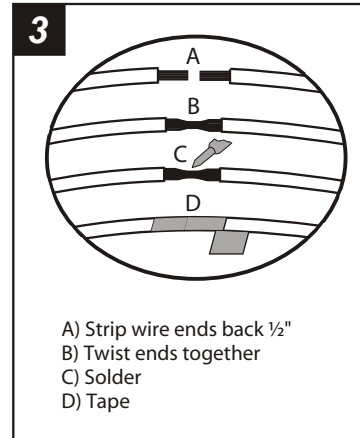

- A) Strip wire ends back 1/2"
- B) Twist ends together
- C) Solder
- D) Tape

3 Locate the factory wiring harness in the dash. Metra recommends using the proper mating adaptor and making connections as shown. (Isolate and individually tape off the ends of any unused wires to prevent electrical short circuit).

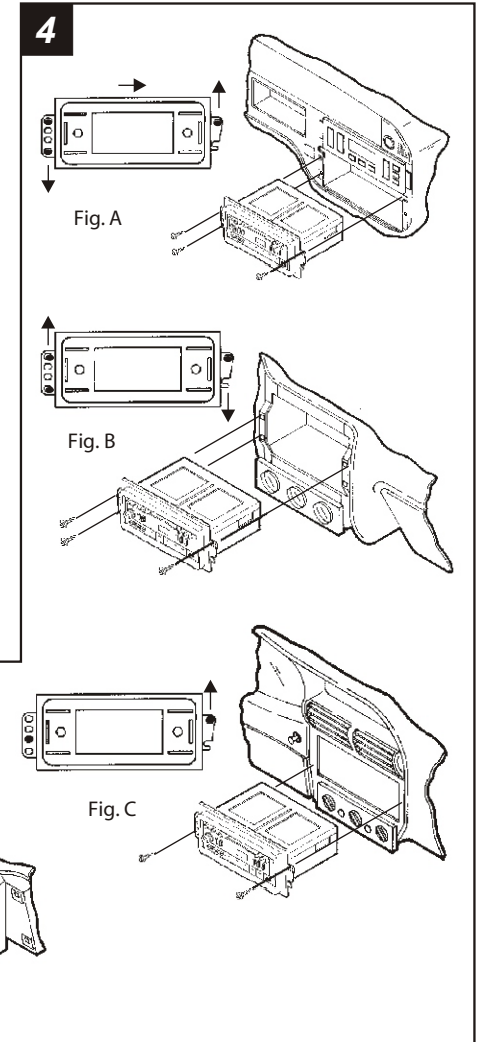

BONNEVILLE: Re-connect the battery terminal and test the unit for proper operation. Position the kit as indicated and mount the head unit/kit assembly to the sub-dash with (3) 7mm hex-head screws previously removed in step #1. (see Fig. A)

FIREBIRD 1993, TRANS AM 1993: Re-connect the battery terminal and test the unit for proper operation. Mount the head unit/kit assembly to the sub-dash with (4) 7mm hex-head screws previously removed in step #1.

FIREBIRD 1994-02, TRANS AM 1994-02: Re-connect the battery terminal and test the unit for proper operation. Mount the head unit/kit assembly to the sub-dash with (3) 7mm hex-head screws previously removed in step #1.

GRAND AM: Re-connect the battery terminal and test the unit for proper operation. Position the kit as indicated and mount the head unit/kit assembly to the sub-dash with (3) 7mm hex-head screws previously removed in step #1. (see Fig. B)

GRAND PRIX: Re-connect the battery terminal and test the unit for proper operation. Position the kit as indicated and mount the head unit/kit assembly to the sub-dash with (2) 7mm hex-head screws previously removed in step #1. (see Fig. C)

SUNFIRE: Re-connect the battery terminal and test the unit for proper operation. Position the kit as indicated and mount the head unit/kit assembly to the sub-dash with (1) 7mm hex-head screw previously removed ("A") and (1) Phillips Pan-head Screw supplied ("B"). (see Fig. D)