

LED CHASE LIGHT BAR

STLCL

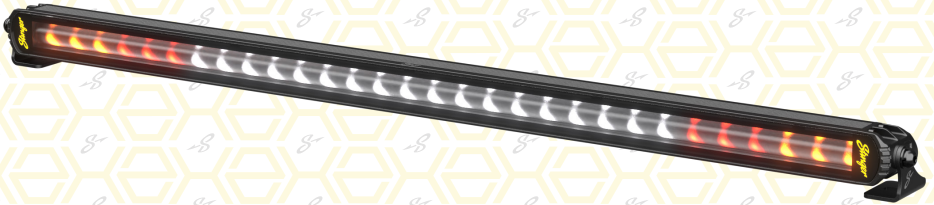

32-INCH CHASE LED LIGHT BAR

User Manual

BOX CONTENTS

- One (1) Chase 32-inch LED light bar
- One (1) 18-inch harness with 8-pin DIN connectors
- Two (2) light bar mounting brackets
- Mounting hardware

FEATURES

- Trail-ready compact design
- High-output LED light engine
- Durable HEXCORE aluminium housing
- Red parking light indicator
- Bright red brake light indicator
- White reverse light indicator
- Amber strobing function
- Left and Right Amber turn signal indicators
- Universal mounting system

TECHNICAL SPECIFICATIONS

- Operating Voltage: 10-30V DC
- Light Source: High-intensity LEDs
- Housing Material: Die-cast aluminium
- Lens Material: Polycarbonate
- Ingress Protection: IP67
- Operating Temperature: -40°F to 149°F (-40°C to 65°C)

REQUIRED TOOLS

- 13mm wrench or 13mm socket and ratchet
- 5mm Allen wrench
- Wire crimpers / strippers

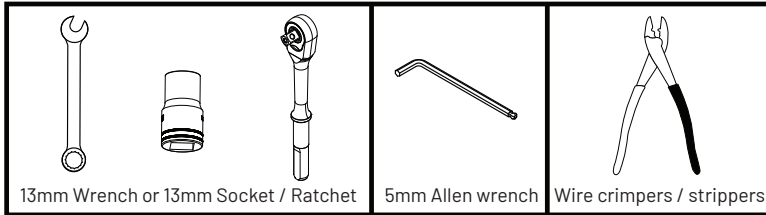

WIRING

PIN	WIRE COLOR	FUNCTION	VEHICLE WIRING
PIN 1	Red	Brake wire	External 12V switch
PIN 2	Blue	Stobe function	12V vehicle brake wire
PIN 3	Black	Ground wire	Chassis ground
PIN 4	Green	Parking wire	12V vehicle parking wire
PIN 5	Orange	R-turn signal wire	12V vehicle R-turn signal
PIN 6	Yellow	L-turn signal wire	12V vehicle L-turn signal
PIN 7	White	Reverse wire	12V vehicle reverse wire
PIN 8	N/A	N/A	N/A

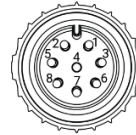

Connector is shown from the PIN side



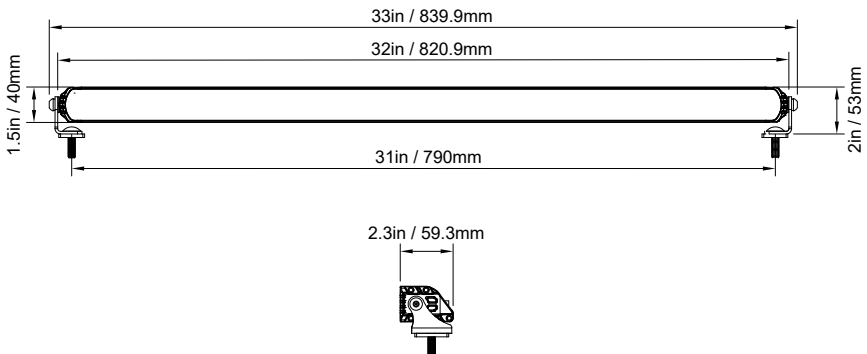







DIMENSIONS

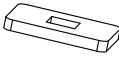

Installation Guide

MOUNTING HARDWARE

- One (1) Left Mounting Bracket
- One (1) Right Mounting Bracket
- Two (2) Rubber Spacers
- Two (2) M8 X 20mm Black Stainless Bolts
- Two (2) M8 Flat Washers
- Two (2) M8 Lock Washers
- Two (2) M8 X 25mm Black Stainless Bolts
- Two (2) M8 Flat Washers
- Two (2) M8 Lock Washers
- Two (2) M8 Black Stainless Nuts

 MOUNTING BRACKET L	 MOUNTING BRACKET R	 RUBBER SPACER	 M8X 20 BOLT	 M8 FLAT WASHER
 M8 LOCK WASHER	 M8 X 25 BOLT	 M8 FLAT WASHER	 M8 LOCK WASHER	 M8 NUT

- Choose a secure, vibration-free mounting surface (rear bumper, roof rack, etc.).
- Ensure the lights do not obstruct airflow, visibility, or vehicle components.
- Attach the mounting brackets to the light bar.
- Loosely secure hardware to allow for beam adjustment.
- Mount the assembly to the vehicle using the provided hardware.

Installation Guide

- Connect the green wire to a positive (+) 12V parking wire.
- Connect the black wire to a (-) negative chassis ground.
- Connect the red wire to a positive (+) 12V brake wire.
- Connect the white wire to a positive (+) 12V reverse wire.
- Connect the yellow wire to a positive (+) 12V left turn signal wire.
- Connect the orange wire to a positive (+) 12V right turn signal wire.
- Connect the blue wire to a positive (+) 12V switch for strobe.

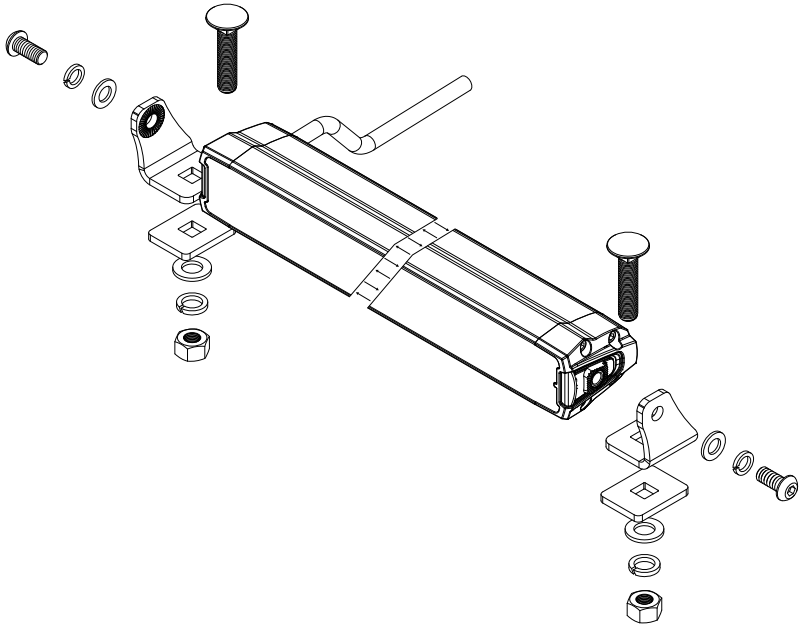



Register Your Product



<https://stingerdrive.com/pages/hexcore-registration>

