

LED STRAIGHT LIGHT BAR

STL30LB



30-INCH STRAIGHT LED LIGHT BAR

User Manual

BOX CONTENTS

- One (1) Straight 30-inch LED light bar
- One (1) 18-inch harness with Deutsch connectors

Note: Universal and vehicle specific harnesses sold separately

- Two (2) light bar mounting brackets
- Mounting hardware

FEATURES

- Trail-ready compact design
- High-output LED light engine
- Durable HEXCORE aluminium housing
- Flood / Spot combo beam pattern
- White or Amber halo backlit
- Weather-sealed design for harsh environments
- Universal mounting system

TECHNICAL SPECIFICATIONS

- Operating Voltage: 10-30V DC
- Light Source: High-intensity LEDs
- Material Housing: Die-cast aluminium
- Material Lens: Polycarbonate
- Ingress Protection: IP67 / IP69K
- Operating Temperature: -40°F to 149°F(-40°C to 65°C)

REQUIRED TOOLS

- 13mm wrench or 13mm socket and ratchet
- Number 5mm Allen wrench
- Wire crimper's or cutters

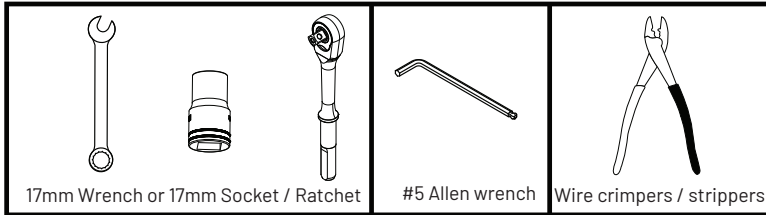

WIRING

PIN	WIRE COLOR	FUNCTION	VEHICLE WIRING
PIN 1	Red	Hi beam power	External 12V switch
PIN 2	Black	Ground	Chassis ground
PIN 3	N/C	No connection	No connection
PIN 4	Green	Low beam switch	External 12V switch
PIN 5	White	White halo	External 12V switch
PIN 6	Yellow	Amber halo	External 12V switch

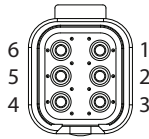

Connector is shown from the wire side



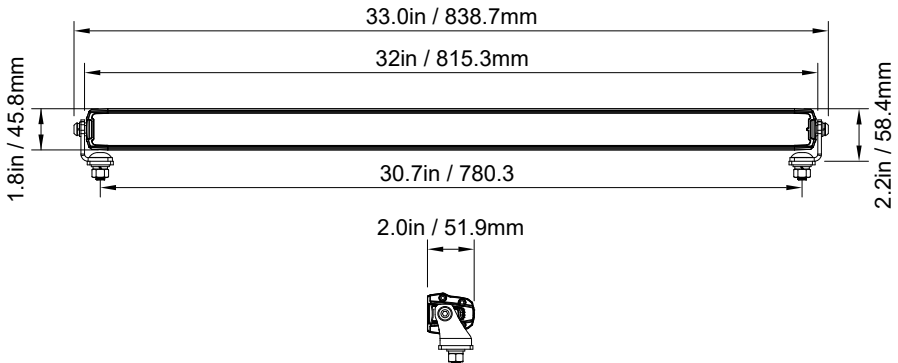







DIMENSIONS

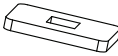

Installation Guide

MOUNTING HARDWARE

- One (1) Left mounting bracket
- One (1) Right mounting bracket
- Two (2) Rubber spacers
- Two (2) M8 X 20mm black oxide bolts
- Two (2) M8 Flat washers
- Two (2) M8 Lock washers
- Two (2) M10 X 25mm black oxide bolts
- Two (2) M10 Flat washers
- Two (2) M10 Lock washers
- Two (2) M10 Nuts

 MOUNTING BRACKET L	 MOUNTING BRACKET R	 RUBBER SPACER	 M8X 20 BOLT	 M8 FLAT WASHER
 M8 LOCK WASHER	 M10 X 25 BOLT	 M10 FLAT WASHER	 M10 LOCK WASHER	 M10 NUT

- Choose a secure, vibration-free mounting surface (bumper, roof rack, A-pillar, etc.).
- Ensure the lights do not obstruct airflow, visibility, or vehicle components.
- Attach the mounting brackets to the light bar.
- Loosely secure hardware to allow for beam adjustment.
- Mount the assembly to the vehicle using the provided hardware.

Installation Guide

- ◆ Connect the red wire to a positive (+) 12V switch for Hi beam.
- ◆ Connect the green wire to a positive (+) 12V switch for Low beam.
- ◆ Connect the black wire to a clean chassis ground.
- ◆ Connect the yellow wire to a positive (+) 12V switch for amber halo.
- ◆ Connect the white wire to a positive (+) 12V switch for white halo.

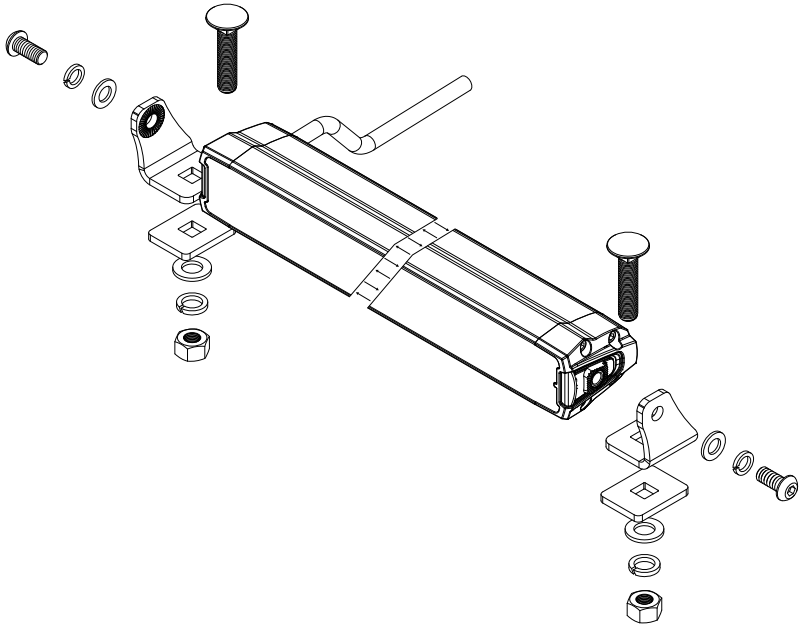

Installation Guide

