

LED POD

STL2X4PDL



2X4-INCH LED POD LIGHT

User Manual

BOX CONTENTS

- Two (2) LED Pod lights
- Two (2) 18-inch harness with Deutsch connectors

Note: Universal and vehicle specific harnesses sold separately

- Two (2) Stinger Black-out covers
- Two (2) Amber lens covers
- Two (2) Pod light mounting brackets

FEATURES

- Trail-ready compact design
- High-output LED light engine
- Durable HEXCORE aluminium housing
- Spot beam pattern
- White or Amber halo backlit
- Weather-sealed design for harsh environments
- Universal mounting system

TECHNICAL SPECIFICATIONS

- Operating Voltage: 10-30V DC
- Light Source: High-intensity LEDs
- Material Housing: Die-cast aluminium
- Material Lens: Polycarbonate
- Ingress Protection: IP67 / IP69K
- Operating Temperature: -40°F to 149°F (-40°C to 65°C)

REQUIRED TOOLS

- 13mm wrench or 13mm socket and ratchet
- Number 4mm Allen wrench
- Wire crimper's or cutters

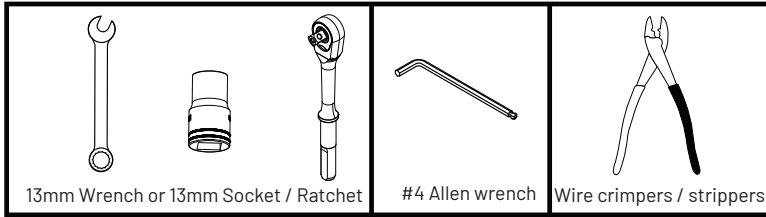

WIRING

PIN	WIRE COLOR	FUNCTION	VEHICLE WIRING
PIN 1	Red	Hi beam power	External 12V switch
PIN 2	Black	Ground	Chassis ground
PIN 3	N/C	No connection	No connection
PIN 4	Green	Low beam switch	External 12V switch
PIN 5	White	White halo	External 12V switch
PIN 6	Yellow	Amber halo	External 12V switch

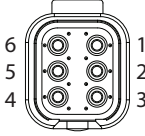

Connector is shown from the wire side



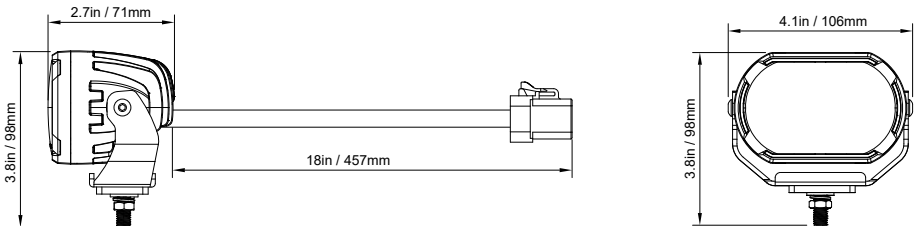





DIMENSIONS

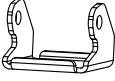
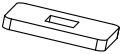

Installation Guide

MOUNTING HARDWARE

- Two (2) Mounting brackets
- Two (2) Rubber spacers
- Four (4) M6 X 20mm black oxide bolts
- Four (4) M6 Rubber washers
- Four (4) M6 Lock washers
- Two (2) M8 X 25mm black oxide bolts
- Two (2) M8 Flat washers
- Two (2) M8 Lock washers
- Two (2) M8 Nuts

 Mounting Bracket	 Rubber Spacer	 M6X 20 BOLT	 M6 RUBBER WASHER	 M6 LOCK WASHER
 M8 X 25 BOLT	 M8 FLAT WASHER	 M8 LOCK WASHER	 M8 NUT	

- Choose a secure, vibration-free mounting surface (bumper, roof rack, A-pillar, etc.).
- Ensure the lights do not obstruct airflow, visibility, or vehicle components.
- Attach the mounting brackets to the pod light.
- Loosely secure hardware to allow for beam adjustment.
- Mount the assembly to the vehicle using the provided hardware.

Installation Guide

- ◆ Connect the red wire to a positive (+) 12V switch for Hi beam.
- ◆ Connect the green wire to a positive (+) 12V switch for Low beam.
- ◆ Connect the black wire to a clean chassis ground.
- ◆ Connect the yellow wire to a positive (+) 12V switch for amber halo.
- ◆ Connect the white wire to a positive (+) 12V switch for white halo.

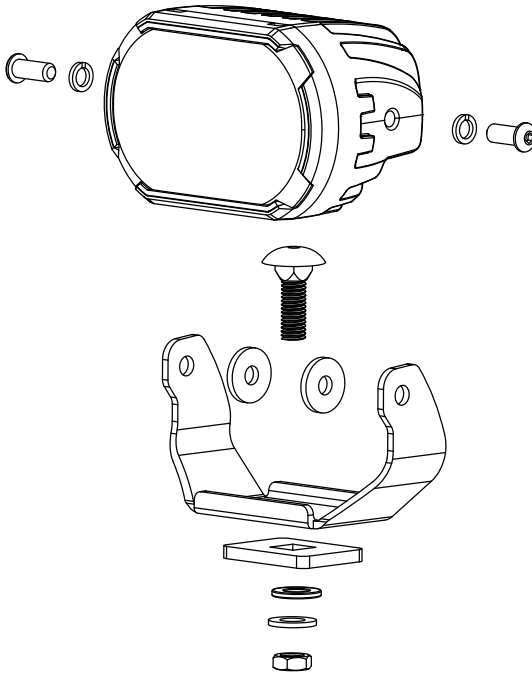

Installation Guide

