

Modus

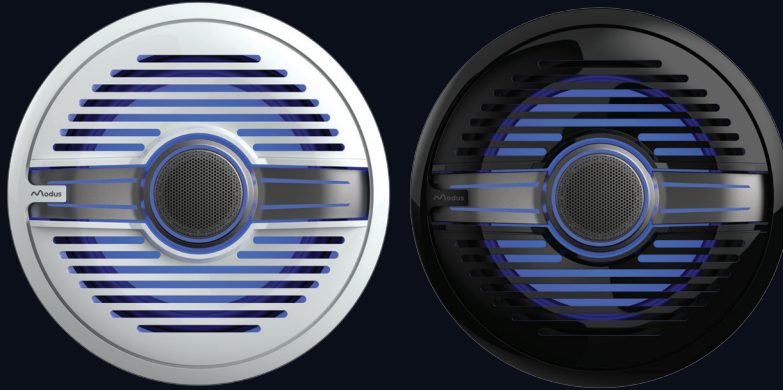

USER MANUAL | MZS-6.5MCL / MZS-7.7MCL / MZS-8.8MCL
Coaxial Speakers | Marine Grade | RGB Lighting | Synthetic Soft Dome Tweeter

Welcome to Modus.

You've chosen precision performance that works seamlessly in the background of every adventure. This user manual will help you unlock your system's full potential. Take a moment to review this manual and keep it stored in a convenient place for future reference.

Introduction

This product is designed as a marine grade speaker for dedicated use in a boat or powersports vehicle, and designed for infinite-baffle applications (speaker enclosure is not required for operation). The speaker is built with a 2-way system: a polypropylene cone and a synthetic soft dome tweeter. A 2-way crossover is also built in. The speaker grille is made from UV- and corrosion resistant plastic. The speaker can be illuminated with the integrated RGB LED lights.

The marine grade speaker is engineered to be weatherproof (IP66 rated), resistant to water and salt spray.

What's in the box

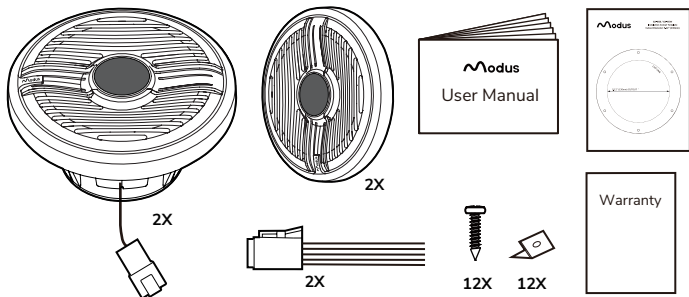

When first unpacking this product, please check that the package contains each of the items listed below. If something is missing, contact the place of purchase.

- 2x Marine speakers
- 2x Spare speaker grilles (with black or white color option)
- 2x Wire harnesses
- 12x Mounting screws (BA4 x 35 mm) and clip nuts
- Installation cutout template
- User manual
- Warranty

Specifications

Technical Data	MZS-6.5MCL	MZS-7.7MCL	MZS-8.8MCL
Speaker drivers	6.5" woofer (polypropylene cone, TPV surround) 1" tweeter (synthetic soft dome)	7.7" woofer (polypropylene cone with mica, TPV surround) 1" tweeter (synthetic soft dome)	8.8" woofer (polypropylene cone with carbon, TPV surround) 1" tweeter (synthetic soft dome)
Power Handling	100W RMS	120W RMS	150W RMS
Frequency Response	70 Hz – 20 kHz	70 Hz – 20 kHz	70 Hz – 20 kHz
Sensitivity	87 dB (1 watt/1 meter)	87 dB (1 watt/1 meter)	90 dB (1 watt/1 meter)
Nominal Impedance	4 Ω	4 Ω	4 Ω

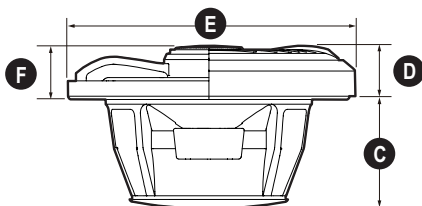
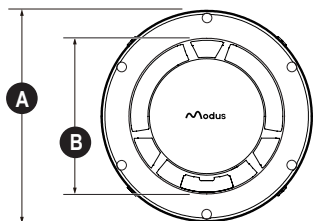

Speaker Dimensions	MZS-6.5MCL	MZS-7.7MCL	MZS-8.8MCL
Overall Diameter (A)	6.89" (175 mm)	7.83" (199 mm)	8.86" (225 mm)
Mounting Hole Diameter (B)	5.08" (129 mm)	6.26" (159 mm)	7.13" (181 mm)
Mounting Depth (C)	2.68" (68 mm)	3.19" (81 mm)	3.62" (92 mm)
Grille Protrusion (D)	1.3" (33 mm)	1.38" (35 mm)	1.46" (37 mm)
Overall Speaker with Grille (E)	7.17" (182 mm)	8.11" (206 mm)	9.13" (232 mm)
Tweeter Protrusion (F)	1.3" (33 mm)	1.46" (37 mm)	1.57" (40 mm)

LED Light color selection (by connecting individual or a combination of light wires to ground)

Light Color	Red	Green	Blue	Yellow	Pink	Aqua	White
Wire Color(s)	Red	Green	Blue	Red + Green	Red + Blue	Green + Blue	Red + Green + Blue

See the section "LED light wiring" on page 3 for light wire connection.

Wiring

Precautions

Prior to installation, disconnect the negative terminal of the vessel battery.

Connect the LED lighting to 12V power supply only. Do not connect the LED lighting to the vessel's navigational lighting circuits.

Avoid routing wires near any sharp or moving parts. Run wires away from other wires that may cause unwanted noise. Insulate bare wires properly. Seal connections to ensure water-tight connection.

Deutsch connector

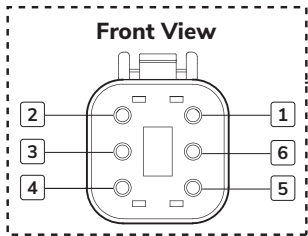

Recommended fuse size for LED light

MZS-6.5MCL	MZS-7.7MCL	MZS-8.8MCL
500mA	500mA	500mA

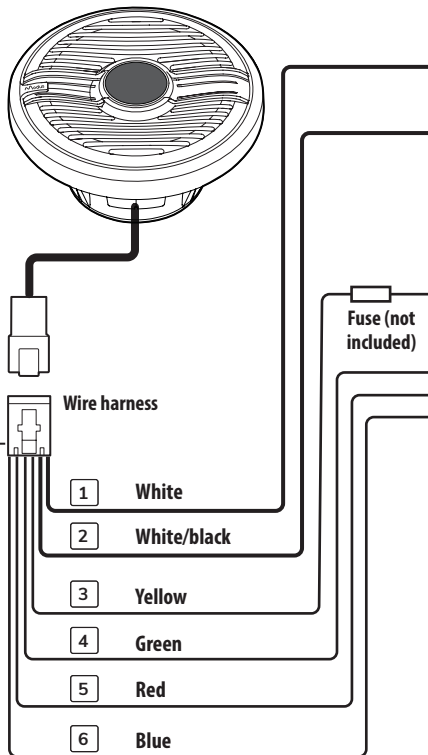

Audio signal wiring

- Connect to audio outputs of your amplifier, **white** wire for positive terminal and **white/black** wire for negative terminal.
- Use 18 gauge (or heavier) wires to extend the speaker wires.

LED light wiring

- Connect the **yellow** wire to a switched +12V supply to turn on or off the LED lighting.
- Connect the **red, green, or blue** wires to the grounding plate or to the negative battery terminal.
- Use 22 gauge (or heavier) wires to extend LED light wires.

Notes for LED wiring

- For short-circuit protection, remember to install a fuse (not included, see the table on the left) in the yellow wire for each speaker. Connect all yellow wires from all the speakers to a switched +12V supply. Also make sure to add a fuse to the switched +12V supply according to the total number of the speakers connected.
- You can connect individual light wires or a combination of light wires to achieve different LED light colors. See page 2.

Mounting

Precautions

Before you drill or cut any holes, investigate your vessel's layout very carefully. Take special care when you work near the fuel tank, fuel lines, hydraulic lines and electrical wiring.

Choose a mounting surface that has sufficient depth to accept the speaker.

Make sure the speaker is firmly secured and the mounting area is sufficiently stable.

Step 1: Detach the grille

Hold the edge of the grille and turn the grille counter-clockwise. The grille will then slide off as the tabs are disengaged from the slots on the basket's edge, allowing removal.

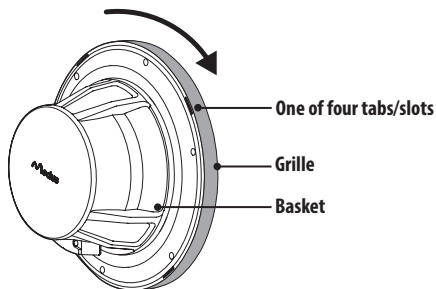

Step 2: Mount the speaker

1. Use the supplied cut-out template to mark the mounting hole and screw holes on the mounting surface.
2. Cut the mounting hole in the surface.
3. Secure the speaker in the mounting hole using the supplied screws and clip nuts.

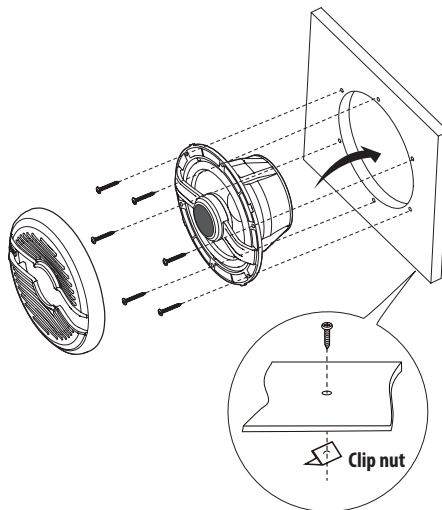

Step 3: Attach the grille

1. Align the four tabs on the basket and four slots on the grille, and correctly place the grille onto the basket.

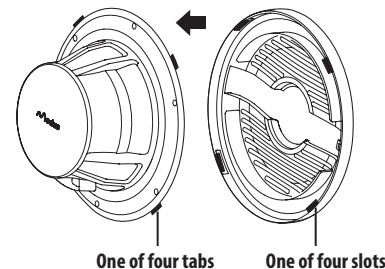

2. Turn the grille clockwise to lock the grille into place.

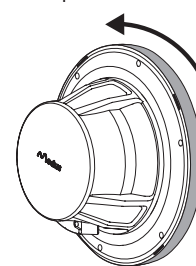

USER MANUAL

Modus
1451 Vanguard Drive, Oxnard, CA 93033
www.modusglobal.com
Customer Service 805-790-7383
Tech Support: <https://support.modusglobal.com>



0126
V:A