



## INSTALLATION INSTRUCTIONS FOR PART 95-5812

### APPLICATIONS

#### FORD

Edge 2007 / Expedition 2007  
 F-150 2004-07 / FreeStar 2004-07  
 Mustang 2005-07 / Five-Hundred 2005-07  
 Freestyle 2005-07 / Focus 2005-07 / Super Duty 2008  
 F Series 2005-07 / Fusion 2006-07 / Explorer 2006-07  
 Explorer Sport Trac 2006-07  
 Taurus 2008, Taurus X 2008

#### MERCURY

Monterey 2004-07 / Milan 2006-07  
 Montego 2005-07 / Mountaineer 2006-07  
 Sable 2008

#### LINCOLN

Lincoln Mark LT 2005-07  
Factory Nav Only: MKX 2007 / MKZ 2007 / Navigator 2007  
 Zephyr 2006

# 95-5812

### KIT FEATURES

- Double DIN Radio Provision
- Stacked ISO DIN Head Unit Provision



### KIT COMPONENTS

- A) Radio Housing (Double DIN and Stacked ISO DIN) • B) Double DIN Brackets • C) Spacers  
 • D) (4) Screws

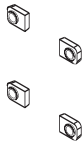
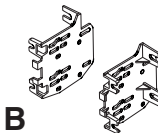
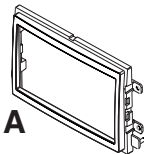

### TOOLS REQUIRED:

Cutting Tool • Panel Removal Tool • Phillips Screwdriver • Socket Set

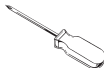

1-800-221-0932



[www.metraonline.com](http://www.metraonline.com)

© COPYRIGHT 2004-2007 METRA ELECTRONICS CORPORATION

## **TABLE OF CONTENTS**

### **Dash Disassembly**

<b>Ford Edge 2007.....</b>	<b>1</b>
<b>Ford F-150 2004-2006 / Expedition 2007.....</b>	<b>1</b>
<b>Lincoln Mark LT 2005-2007.....</b>	<b>1</b>
<b>Ford Mustang 2005-2007.....</b>	<b>2</b>
<b>Ford Five Hundred 2005-2007.....</b>	<b>3</b>
<b>Mercury Sable 2008.....</b>	<b>3</b>
<b>Ford Taurus 2008.....</b>	<b>3</b>
<b>Mercury Montego 2005-2007.....</b>	<b>3</b>
<b>Ford Fusion 2006-2007.....</b>	<b>4</b>
<b>Mercury Milan 2006-2007.....</b>	<b>4</b>
<b>Ford Freestyle 2005-2007.....</b>	<b>5</b>
<b>Ford Taurus X 2008.....</b>	<b>5</b>
<b>Ford Freestar 2004-2007.....</b>	<b>6</b>
<b>Mercury Monterey 2004-2007.....</b>	<b>6</b>
<b>Ford Focus 2005-2007.....</b>	<b>7</b>
<b>Ford Explorer 2006-07.....</b>	<b>8</b>
<b>Ford Explorer Sport Trac 2006-2007.....</b>	<b>8</b>
<b>Mercury Mountaineer 2006-2007.....</b>	<b>8</b>
<b>Ford F Series Super Duty 2005-2007.....</b>	<b>9</b>
<b>Ford Super Duty 2008.....</b>	<b>10</b>
<b>Lincoln Navigator 2007.....</b>	<b>11</b>
<b>Lincoln MKX 2007.....</b>	<b>12</b>
<b>Lincoln MKZ 2007.....</b>	<b>13,14</b>
<b>Lincoln Zephyr 2006.....</b>	<b>13,14</b>

### **Kit Assembly**

<b>Double DIN Head Unit Provision.....</b>	<b>15</b>
<b>Stacked ISO DIN Head Unit Provision.....</b>	<b>16</b>

<b><u>Final Assembly</u>.....</b>	<b>17</b>
-----------------------------------	-----------

*\*Note: Refer also to the instructions included with the aftermarket radio.*

**FORD F-150 2004-2007**  
**LINCOLN MARK LT 2005-2006**  
**FORD EXPEDITION 2007**  
**FORD EDGE 2007**

- 1** Disconnect the negative battery terminal to prevent an accidental short circuit.
- 2** Unsnap and remove entire panel surrounding the radio and climate controls. (Figure A)
- 3** Remove (4) 9/32" screws to remove the factory radio. (Figure B)

*Continue to kit assembly.*

**A**

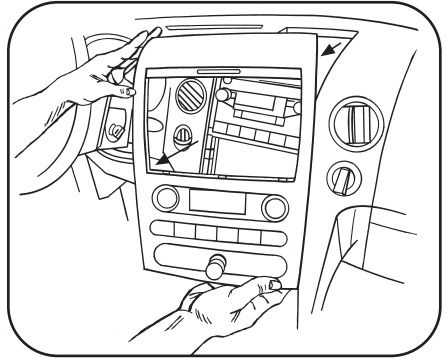

**B**

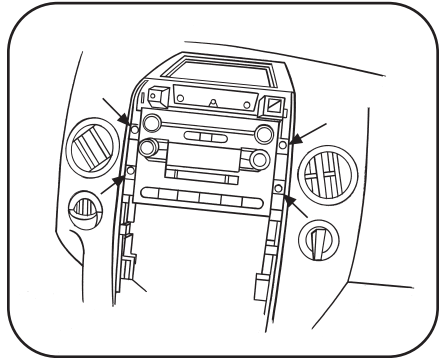

**FORD MUSTANG 2005-2007**

*\*Note: Refer also to the instructions included with the aftermarket radio.*

- 1** Disconnect the negative battery terminal to prevent an accidental short circuit.
- 2** Remove the small rectangular shifter lever trim panel if equipped. (Figure A)
- 3** Remove (2) Phillips screws from under the center armrest at the back of the shifter trim panel (including cup holders). (Figure B)
- 4** Unclip and remove panel. (Figure B)
- 5** Unclip and remove the (2) center stack trim panels from the left and right side of the radio and climate controls. (Figure C)
- 6** Remove (6) 9/32" screws from center trim panel surrounding the radio and climate controls then unclip and remove panel. (Figure D)
- 7** Remove (4) 9/32" screws from the radio to remove. (Figure E)

*Continue to final assembly.*

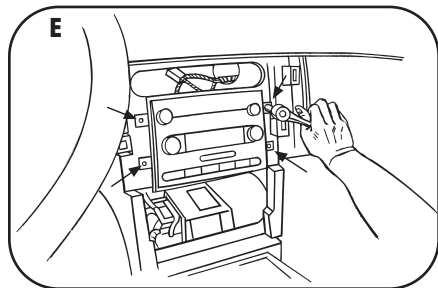
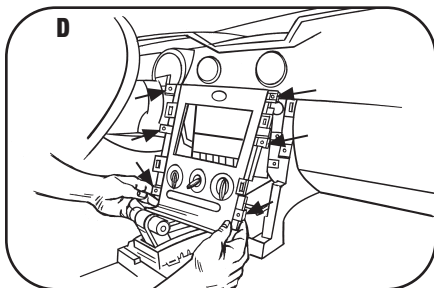
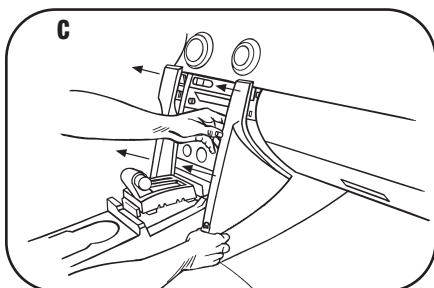
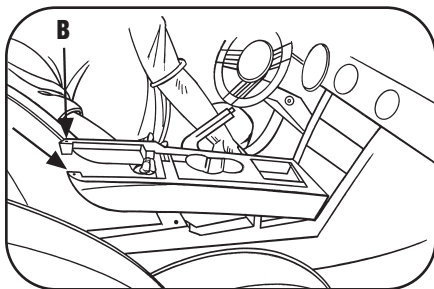
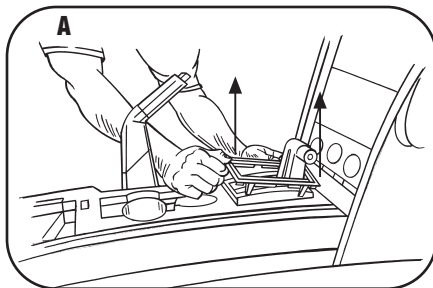

**FORD FIVE-HUNDRED 2005-2007/FORD TAURUS 2008  
MERCURY MONTEGO 2005-2007, MERCURY SABLE 2008**

*\*Note: Refer also to the instructions included with the aftermarket radio.*

- 1 Disconnect the negative battery terminal to prevent an accidental short circuit.
- 2 Unclip and remove the small rectangular trim around shift lever. (Figure A)
- 3 Unclip and remove the entire panel (including cup holders) surrounding the shift lever. (Figure B)
- 4 Remove (2) 9/32" screws at the bottom of the center radio/climate control panel. (Figure C)
- 5 Unclip and remove the center panel. (Figure D)
- 6 Remove (4) 9/32" screws from the radio to remove. (Figure E)

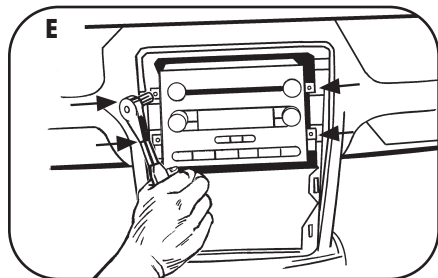
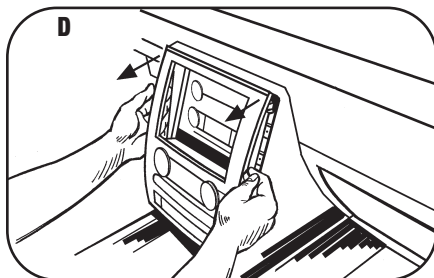
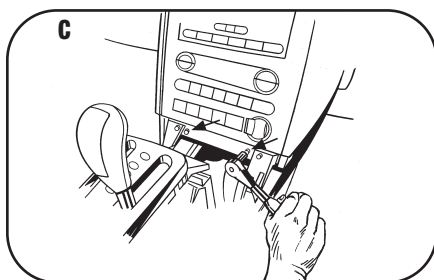
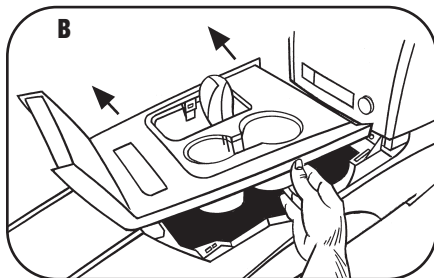
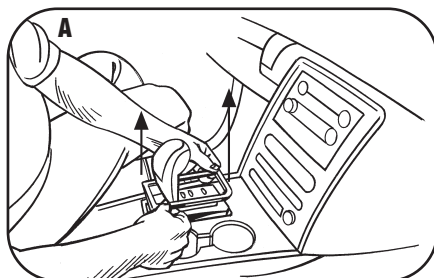

*Continue to final assembly.*

**FORD FUSION 2006-2007**  
**MERCURY MILAN 2006-2007**

- 1** Disconnect the negative battery terminal to prevent an accidental short circuit.
- 2** Unsnap and remove entire panel surrounding the radio and climate controls. (Figure A)
- 3** Remove (4) 9/32" screws to remove the factory radio. (Figure B)

*Continue to kit assembly.*

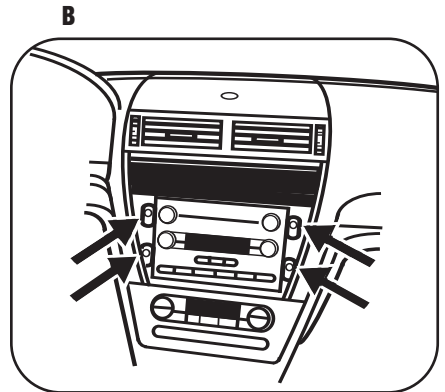
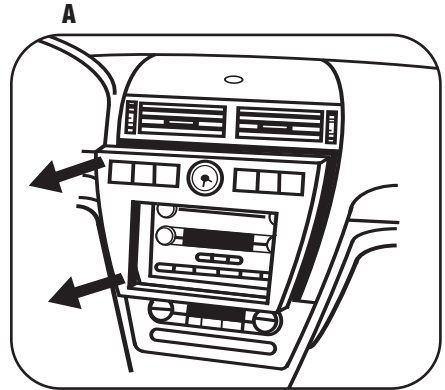

**FORD FREESTYLE 2005-2007**  
**FORD TAURUS X 2008**

- 1** Disconnect the negative battery terminal to prevent an accidental short circuit.
- 2** Unclip and remove entire panel surrounding the radio and a/c controls. (Figure A)
- 3** Remove (4) 9/32" screws from radio to remove. (Figure B)

*Continue to kit assembly.*

**A**

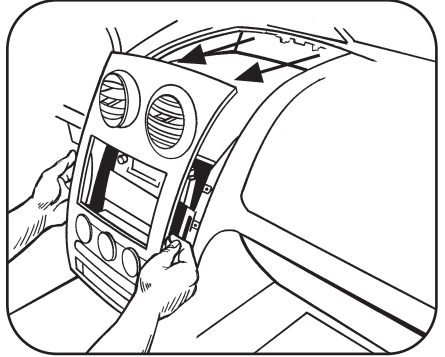

**B**

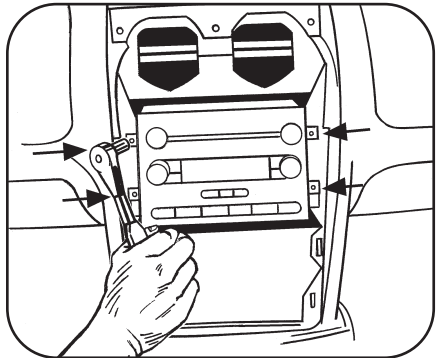

**FORD FREESTAR 2004-2007**  
**MERCURY MONTEREY 2004-2007**

- 1 Disconnect the negative battery terminal to prevent an accidental short circuit.
- 2 Unsnap and remove entire panel surrounding the radio and climate controls. (Figure A)
- 3 Remove (4) 9/32" screws to remove the factory radio. (Figure B)

*Continue to kit assembly.*

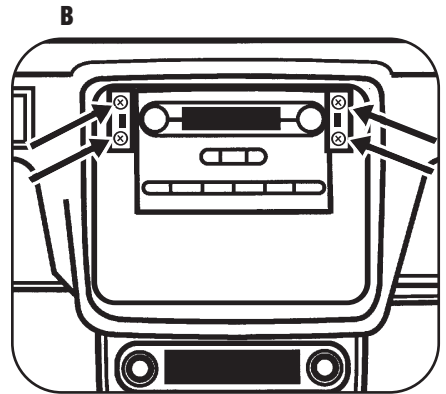
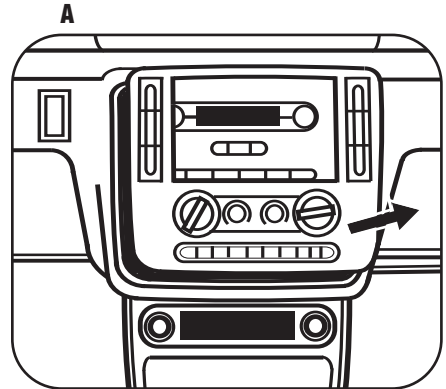



**FORD FOCUS 2005-2007**

- 1** Disconnect the negative battery terminal to prevent an accidental short circuit.
- 2** Unsnap and remove entire panel surrounding the radio and climate controls. (Figure A)
- 3** Remove (4) 9/32" screws to remove the factory radio. (Figure B)

*Continue to kit assembly.*

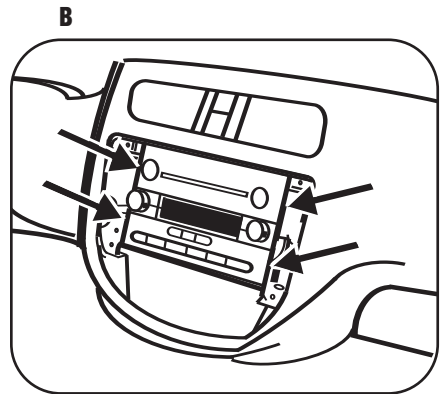
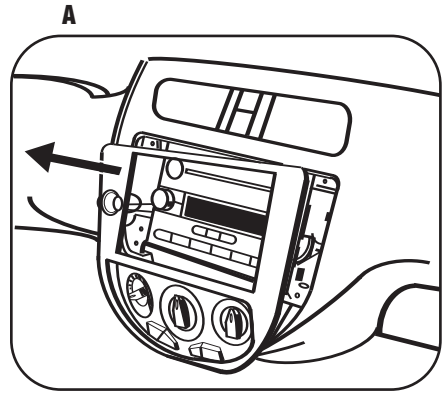

**FORD EXPLORER/EXPLORER SPORT TRAC 2006-2007  
 MERCURY MOUNTAINEER 2006-2007**

- 1** Disconnect the negative battery terminal to prevent an accidental short circuit.
- 2** Open center console and remove (2) Phillips screws then unclip and remove entire panel surrounding shifter. (Figure A)

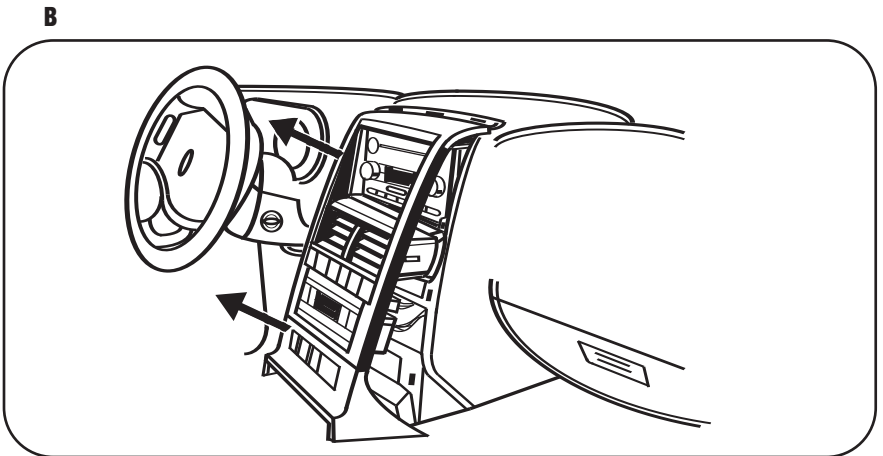
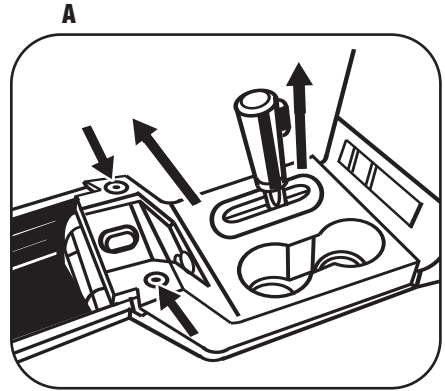

- 3** Remove dash panel surrounding radio to access the factory radio screws. (Figure B)
- 4** Remove (4) 9/32" screws to remove the factory radio. (Figure C)

*Continue to kit assembly.*

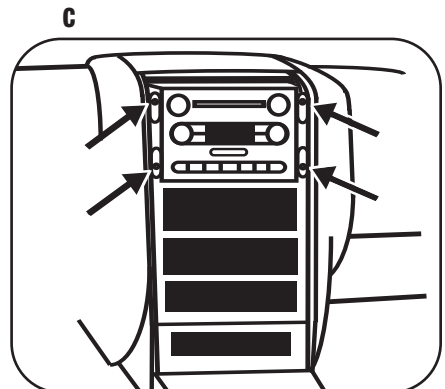

**FORD F SERIES SUPER DUTY 2005-2007**

- 1 Disconnect the negative battery terminal to prevent an accidental short circuit.
- 2 Unsnap and remove entire panel surrounding the radio and climate controls. (Figure A)

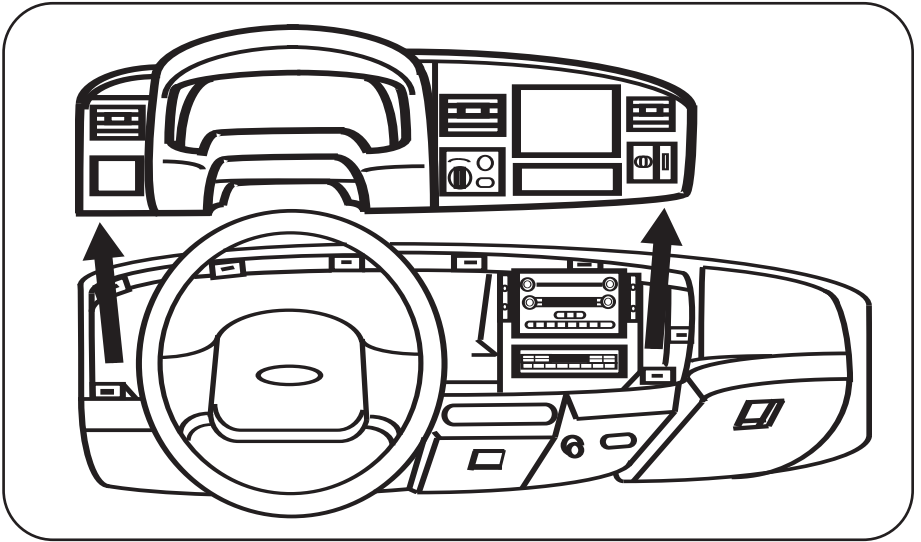
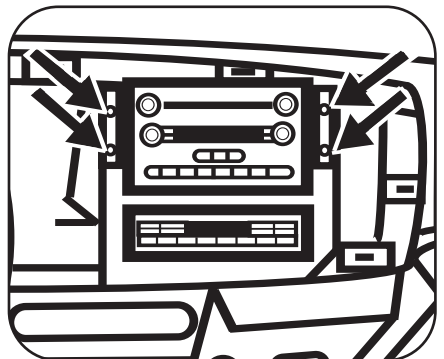
**A**

**B**

- 3 Remove (4) 9/32" screws to remove the factory radio. (Figure B)

*Continue to kit assembly.*

## **FORD SUPER DUTY 2008**

- 1** Disconnect the negative battery terminal to prevent an accidental short circuit.
- 2** Unclip and remove the power outlet panel and the blank panel on the left and right side of the radio trim panel.  
(Figure A)

**A**

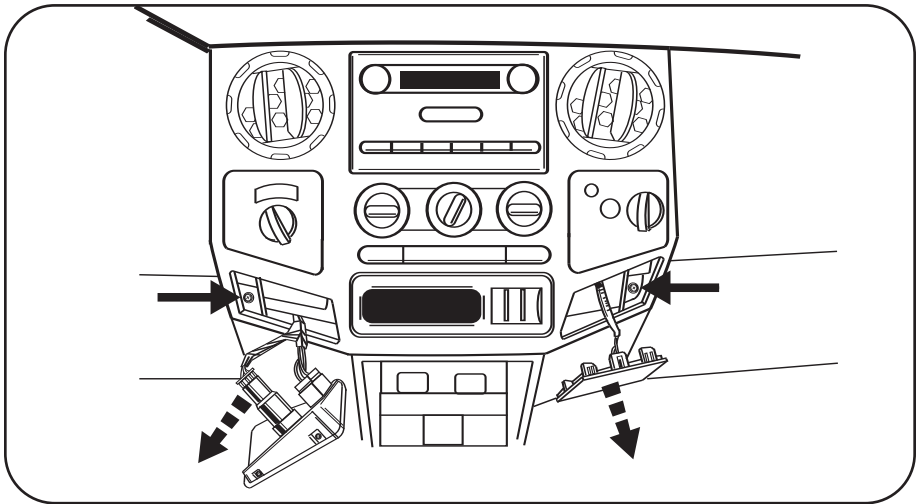

- 3** Remove the (2) 9/32" screws exposed behind the two panels remove in step 2.
- 4** Unclip and remove the entire radio trim panel including the a/c control and vents.
- 5** Remove (4) 9/32" screws securing the radio.

*Continue to kit assembly*

## LINCOLN NAVIGATOR 2007

- 1** Disconnect the negative battery terminal to prevent an accidental short circuit.
- 2** Unclip and remove the panel surrounding the shifter. (Figure A)
- 3** Remove (2) 9/32" screws from the bottom of the radio/climate control trim panel. (Figure B)
- 4** Unclip and remove the entire panel surrounding the radio and including the climate controls. (Figure B)
- 5** Remove (4) 9/32" screws securing the radio. Unplug and remove the Radio.

*Continue to kit assembly.*

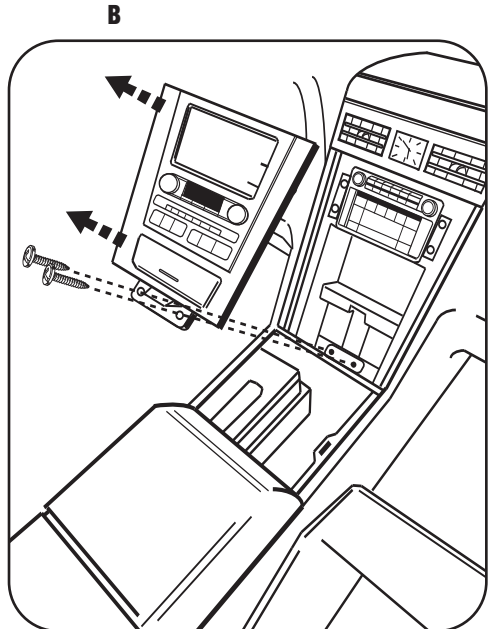
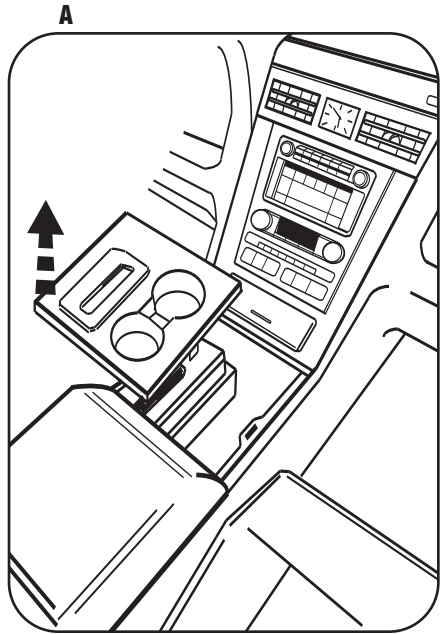

## LINCOLN MKX 2007

- 1** Disconnect the negative battery terminal to prevent an accidental short circuit.
- 2** Open center console lid and unclip and remove the center console trim panel surrounding the shifter. (Figure A)
- 3** Remove (2) Phillips screws from the storage bin then unclip and remove the bin. (Figure B)
- 4** Unclip and remove the upper and lower center trim panel as one assembly. (Figure C)
- 5** Remove (4) 9/32" screws securing the radio. Unplug and remove the Radio.

*Continue to kit assembly.*

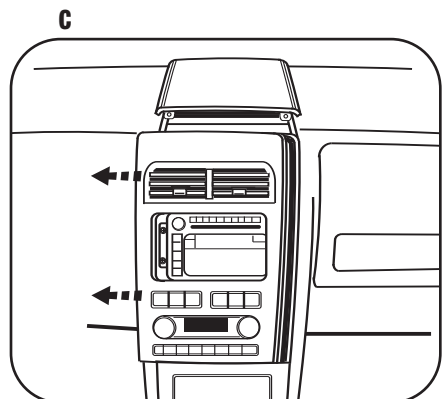
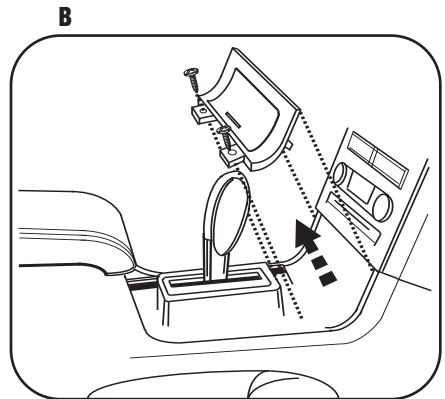
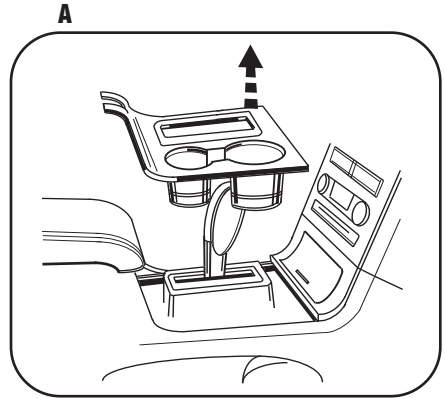

**LINCOLN MKZ 2007/LINCOLN ZEPHYR 2006**

- 1 Disconnect the negative battery terminal to prevent an accidental short circuit.
- 2 Unclip and remove the top of the center console. (Figure A)
- 3 Open ashtray door and remove ashtray then remove (1) Phillips screw from inside ashtray cavity. Close ashtray door.
- 4 Unclip and remove the climate control and trim panel assembly starting at the bottom edge. (Figure B)
- 5 Open the climate control vents and pull straight outward to remove. (Figure C)

*Continue on page 14.*

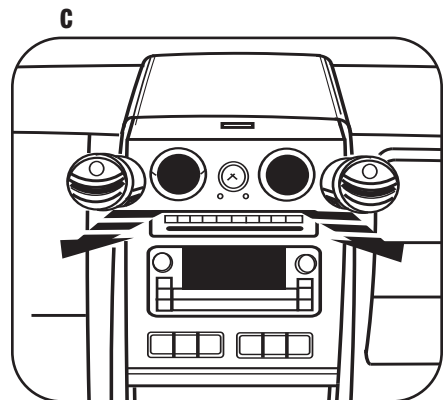
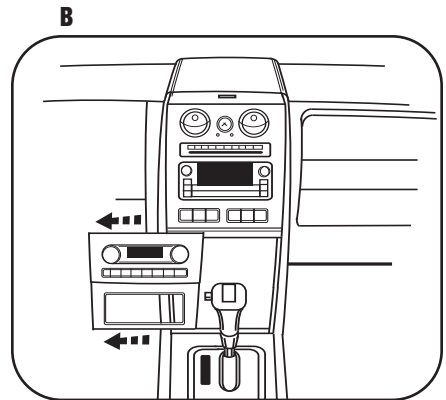
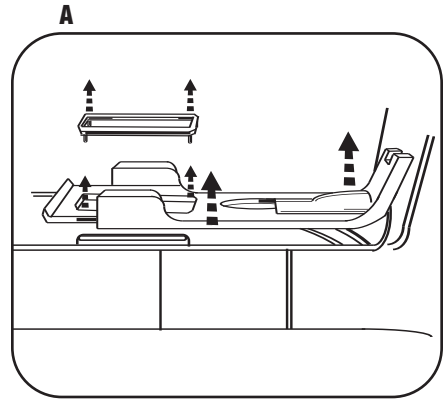

**LINCOLN MKZ 2007/LINCOLN ZEPHYR 2006**

- 6** Remove (2) 9/32" from the bottom of the radio trim panel assembly and (2) 9/32" screws from inside the vents. (Figure D)
- 7** Unclip the radio trim panel/radio assembly. Unplug and remove assembly. (Figure D)
- 8** Remove (4) 9/32" screws securing the radio to the trim panel and remove the radio. (Figure E)

*Continue to kit assembly.*

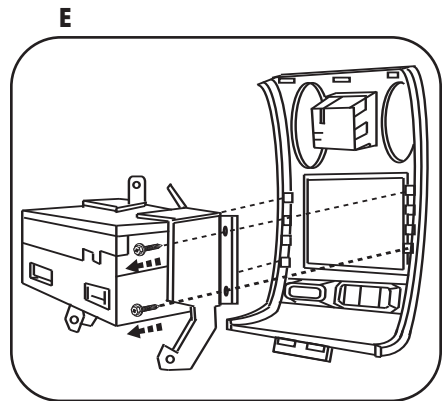
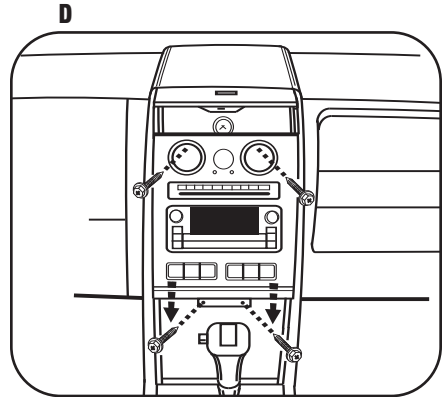



## DOUBLE DIN RADIO PROVISION

*\*Note: Refer also to the instructions included with the aftermarket radio.*

- For the **2007 Ford Edge/Expedition, 2006-07 Explorer/Fusion/Mercury Milan, 2004-07 F-150, 2005-07 Five Hundred/Freestyle/Mustang/Mercury Montego, 2005-07 Lincoln Mark LT** and the **2008 Super Duty**, cut and remove the rear mounting tabs from the Double DIN Brackets  
a. If your vehicle is not listed above move to step 2.

- For the **2007 Ford Edge/Expedition, 2006-07 Explorer, 2006-07 Fusion, 2007 Mustang** and the **2008 Super Duty** attach the included spacers to the back of the radio housing mounting tabs.  
a. If your vehicle is not listed above move to step 3. (Figure A)

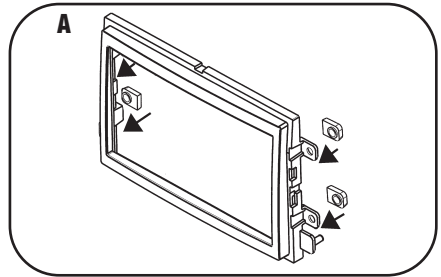

- Attach the double DIN brackets to the radio housing. **Note:** The notch in the housing should be on top. (Figure 3A,3B)

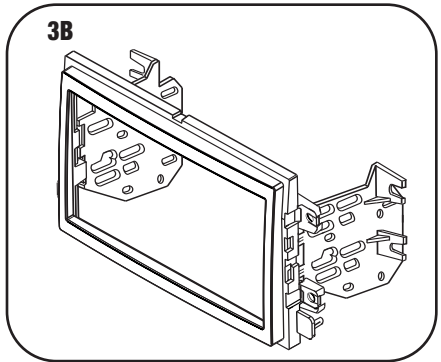
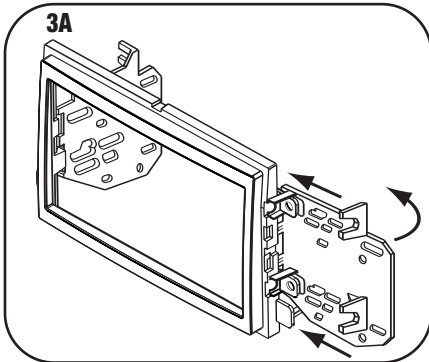

- Slide the Double DIN radio into the radio housing/bracket assembly and secure the radio to the assembly using the screws supplied with the radio. (Figure C)

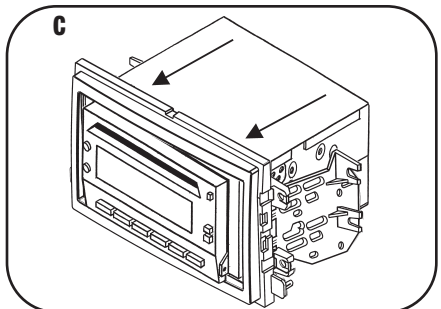

*Continue to kit assembly.*

## STACKED ISO UNITS PROVISION

*\*Note: Refer also to the instructions included with the aftermarket radio.*

- 1** For the **2007 Ford Edge/Expedition, 2006-07 Explorer/Fusion/Mercury Milan, 2004-07 F-150, 2005-07 Five Hundred/Freestyle/Mustang/Mercury Montego, 2005-07 Lincoln Mark LT and the 2008 Ford Super Duty**, cut and remove the rear mounting tabs from the Double DIN Brackets.

a. If your vehicle is not listed above move to step 2.

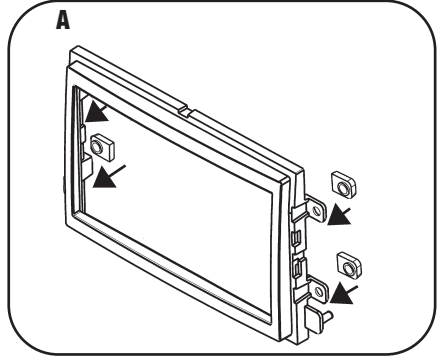

- 2** For the **2007 Ford Edge/Expedition, 2006-07 Ford Explorer, 2006-07 Ford Fusion, 2007 Mustang and the 2008 Super Duty** attach the included spacers to the back of the radio housing mounting tabs.

(Figure A)

a. If your vehicle is not listed above move to step 3.

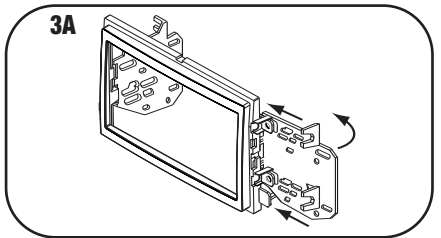

- 3** Attach the double DIN brackets to the radio housing. **Note:** The notch in the housing should be on top.

(Figure 3A,3B)

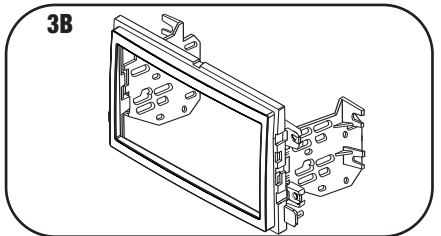

- 4** Slide the ISO mount units into the radio housing/bracket assembly and secure the units to the assembly using the screws supplied with the units.

(Figure C)

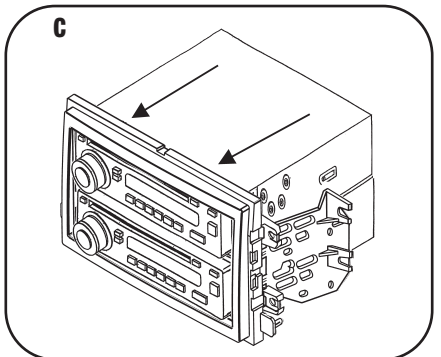

*Continue to kit assembly.*

## FINAL ASSEMBLY

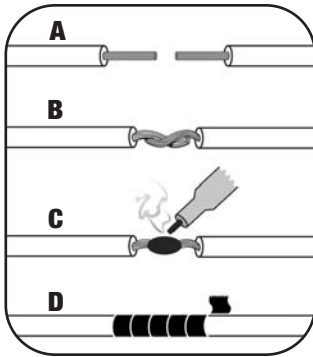

- (A) Strip wire ends back 1/2"**
- B) Twist ends together**
- C) Solder**
- D) Tape**

- 1** Locate the factory wiring harness in the dash. Metra recommends using the proper mating adapter and making connections as shown. (Isolate and individually tape off the ends of any unused wires to prevent electrical short circuit.)
- 2** Re-connect the negative battery terminal and test the unit for proper operation.
- 3** Reassemble radio and dash assemblies in reverse order of disassembly.

### FINAL WIRING CONNECTIONS

Make wiring connections using the EIA color code chart shown below and the instructions included with the head unit. Metra recommends making connections as shown below; Strip, Splice, Solder, Tape. Isolate and individually tape off ends of any unused wires to prevent electrical short circuit.

#### METRA / EIA WIRING CODE

12V Ignition / Acc. . . . . Red	Right Front (+) . . . . . Gray
12V Batt / Memory. . . . . Yellow	Right Front (-). . . . . Gray/ Black
Ground . . . . . Black*	Left Front (+) . . . . . White
Power Antenna. . . . . Blue	Left Front (-). . . . . White / Black
Amp Turn-On . . . . . Blue / White	Right Rear (+) . . . . . Violet
Amp Ground. . . . . Black / White	Right Rear (-). . . . . Violet / Black
Illumination . . . . . Orange	Left Rear (+) . . . . . Green
Dimmer . . . . . Orange / White	Left Rear (-) . . . . . Green / Black

**\*NOTE:** When a Black wire is not present, ground radio to vehicle chassis.  
All colors may not be present on all leads due to manufacturer's specifications.

# 95-5812 INSTRUCTIONS



**1-800-221-0932**



**[www.metraonline.com](http://www.metraonline.com)**

REV. 08/20/07 © COPYRIGHT 2004-2007 METRA ELECTRONICS CORPORATION INST95-5812