

Bliss ProFlex

cozzia

USER MANUAL | CZ-335

Hello.

Congratulations on purchasing your new Bliss ProFlex.

At Cozzia we understand that every body is different and have carefully designed your massage chair with that in mind. But enough about us, this is about you. Learning how to use your new chair is simple (we designed it that way).

So let's get started.

Scan QR Code to Visit Website



Scan QR Code for Operation Video



Scan QR Code for Service Support



For replacement parts and tech support, please call our service and warranty phone number, or visit www.cozzia.com

TABLE OF CONTENTS

	Safety	3-4
 CARE	Grounding Instruction	5
	Troubleshooting	5
	Care and Storage	5
	Warranty	6
 INTRO	Dimensions	7
	Contents	8
	Move & Clearance	9
	Components	10
 CHAIR	Massage Points	11
	Specifications	12
	How To Use	13-28
	Auto Program Descriptions	29-33

SAFETY PRECAUTIONS

We're looking out for you.

IMPORTANT SAFETY INSTRUCTIONS

When using the massage chair, basic precautions should always be followed, including the following:
Read all instructions before using this massage chair.

DANGER - To reduce the risk of electric shock:

- Always unplug this massage chair from the electrical outlet immediately after using and before cleaning.
- Never use pins or other metallic fasteners with this appliance.
- Carefully examine the covering before each use. Call for service if the covering shows any sign of deterioration, such as blistering, peeling or cracking.
- Keep dry - do not operate in a wet or moist condition.

WARNING - To reduce the risks of burns, fire, electric shock or injury to persons:

- Read all instructions before using.
- A massage chair should never be left unattended when plugged in. Unplug from the outlet when it is not in use and before putting on or taking off parts.
- Close supervision is necessary when this massage chair is used by or near children or disabled persons. Keep children away from reclining backrest and extended leg rest.
- Use this massage chair only for its intended use as described in this manual.
- Never operate this massage chair if it has a damaged cord or plug, if it is not working properly, if it has been dropped or damaged, or dropped into water. Contact customer service department.
- Keep the cord away from heated surfaces.
- Never operate the massage chair with the air openings blocked. Keep the air openings free of lint, hair and the like.
- Never drop or insert any object into any opening.
- Do not use outdoors.
- Do not operate where aerosol (spray) products are being used or where oxygen is being administered.
- To disconnect, turn all controls to the off position, then remove the plug from the outlet.
- Do not stand on or in the massage chair. Use only while seated.
- The product is not intended for use by children or persons with reduced physical, sensory or mental capabilities, or lack of experience and knowledge, unless they have been given supervision or instruction concerning use of the product by a person responsible for their safety.
- Children should be supervised to ensure that they do not play with the product.
- Temperatures sufficiently high to cause burns may occur regardless of the control setting. Do not use on an infant or invalid or on a sleeping or unconscious person. Check the skin in contact with the heated area of the appliance frequently to reduce the risk of blistering.
- Burns may result from improper use.
- Do not crush in order to avoid sharp folds.
- Keep children away from extended foot support (or other similar parts).
- DO NOT WET.
- DO NOT USE PINS.
- NEVER REMOVE COVER.
- Connect this appliance to a properly grounded outlet only. See Grounding Instructions.

SAVE THESE INSTRUCTIONS

This massage chair is intended for household use only.

1. Usage Environment

- Do not use the massage chair in an excessively humid or dusty environment as this may result in malfunction or electric shock.
- Do not use the massage chair in a room with a temperature of 104°F or higher.
- Do not expose the massage chair to heaters, stoves or direct sunlight.
- Place and use the massage chair on an even, non-slip floor.
- The massage chair is designed for home use and not for commercial purposes.



Caution

- This massage chair is to be used indoors only.
- If you use the massage chair in a cold room, do not increase the room temperature abruptly. It is recommended that you increase the temperature gradually to a normal level.
- If the massage chair is stored in a cold place and is being brought into a warm environment, it is advisable to wait for one hour before use. This is because its performance may not be at an optimal level, as there may be water droplets on the mechanical parts due to condensation. Using the massage chair under such conditions may result in malfunction.

2. Safety Precautions

- To ensure safe and correct use of the massage chair, do not operate it without reading this operation manual carefully.
- Do not use the massage chair when the upholstery or seat is removed. This may cause injury or malfunction.
- Do not use the massage chair in combination with other therapeutic equipment or electric blanket etc., as this may result in ineffectiveness or injury.
- Do not use the massage chair an hour before or after eating as this may have adverse effects on the user.
- Do not allow children or pets to play around the massage chair, e.g. behind the backrest, under the seat base or legrest of the massage chair. This may result in injury.
- Do not use the massage chair when your body is wet.
- Do not operate the massage chair with wet hands.
- It is not recommended to use the massage chair for more than 30 minutes.
- Do not perform continuous massage on the same spot of your body for more than 5 minutes at a time as this may result in excessive stimulation and may have adverse effects.
- Do not insert your hand or foot along the paths of the massage rollers during use as this may cause injury.
- Stop operation immediately if you feel any discomfort.
- This product is not intended for self-treatment of conditions that should be managed by a qualified health care provider.
- People on medication or with medical conditions, please consult your doctor before use.
- Please do not use the product if you are not feeling well.

3. People with Medical Conditions

Consult your doctor before use if you:

- Are under medical rest as ordered by a doctor.
- Have spinal disorders, an abnormal spinal condition or have suffered a spinal injury.
- Have back problems.
- Have diabetes, osteoporosis or sensory impairment.
- Have joint dysfunction such as rheumatism, hammertoe or gout.
- Have a pacemaker or other electronic medical devices.
- May be pregnant.
- Have phlebitis or thrombosis.
- Have an increased risk for blood clots.
- Had recent surgery.
- Have surgical pins, screws, or anything mechanical in the legs, ankles or feet.



Caution

- Avoid using the massage chair under the influence of alcohol.
- Do not apply massage rollers directly on the head, elbow or knee joints, torso or abdomen.
- If your legs or feet slip off the leg rest during massage, do not force them back in as this may result in injury.
- Remove the power plug from the electrical outlet immediately should liquid be accidentally spilled onto the massage chair. Do not use wet hands to connect or disconnect the power plug from the electrical outlet.
- Do not tamper with the power cord or use the massage chair with a damaged cord as this may result in malfunction and electric shock.

4. Instances When the Massage Chair Should Not Be Used

In the following events, please switch off the main power switch immediately and disconnect the power cord from the electrical outlet:

- If liquid is accidentally spilled onto the massage chair. This may result in electric shock or malfunction.
- If the fabric of the backrest is torn and the internal components are exposed.
- If pain or discomfort is felt during massage, stop operation immediately and consult your doctor.
- If you detect any malfunction or any other abnormal condition during operation.
- If there is power failure. Injury may occur when power is restored unexpectedly.
- If there is lightning.

5. Assembly and Repair of the Massage Chair

- Do not disassemble the backrest cover of the massage chair. Touching the internal components may result in malfunction or electrical shock.
- This massage chair must only be professionally serviced or repaired. Only disassemble or repair the massage chair if directed by a Cozzia service rep.

6. Things to Be Noted About the Power Plug and Cord

- Check that the Alternating Current (AC) voltage corresponds with the specifications indicated for the massage chair.
- Do not connect or disconnect the power plug from the electrical outlet with wet hands. This may result in malfunction or electric shock.
- When disconnecting the power plug, pull it by holding the plug, not the cord.
- Although operation will be stopped automatically by the Auto-Timer function, always remember to switch off the main power after use.
- Do not place the power cord under the massage chair or under any other heavy objects.
- Do not wind the power cord around the massage chair as this may damage the cord and result in a fire or electric shock.
- Do not operate the massage chair with a damaged cord or extension cord.
- Do not use the massage chair if the electrical outlet is loose.
- If the power cord is damaged, it should be replaced by a qualified technician.

FCC Statement

This device complies with Part 15 of the FCC Rules. Operation is subject to the following two conditions: (1) This device may not cause harmful interference, and (2) This device must accept any interference received, including interference that may cause undesired operation.

GROUNDING INSTRUCTIONS

This product must be grounded. If it should malfunction or break down, grounding provides a path of least resistance for the electric current to reduce the risk of electric shock. This product is equipped with a cord that has an equipment-grounding conductor and a grounding plug. The plug must be plugged into an appropriate outlet that is properly installed and grounded in accordance with all local codes and ordinances.

Danger - Improper connection of the equipment-grounding conductor can result in a risk of electric shock. Check with a qualified electrician or service technician if it will not fit the outlet. Have a proper outlet installed by a qualified electrician.

This product is for use on a nominal 120V circuit and has a grounding plug that looks like that plug illustrated below. Make sure that the product is connected to an outlet having the same configuration as the plug. No adapter should be used with this product.

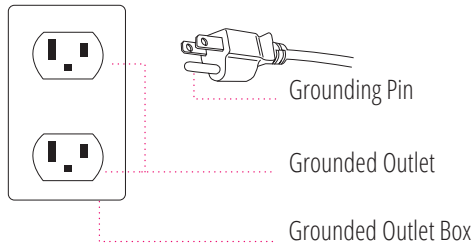

TROUBLESHOOTING

This massage chair is controlled by a microcomputer and is thus susceptible to power surges of +10 to -15%. The following situations may arise in the event of a power surge:

Situation	Solution
The massage chair is connected to the power supply but is not functioning	<ol style="list-style-type: none">1. Check to see that the plug is properly connected and working2. Ensure the massage chair switch is in the 'I' position
The remote control works but the massage chair is not functioning	Possible overheating due to prolonged use. Turn off the power for at least 30 to 50 minutes
Both the remote control and the massage chair are not functioning	<ol style="list-style-type: none">1. Ensure the chair is plugged into a working outlet2. Turn the power OFF and ON again

If you continue to have problems, please read the warranty card and contact the Cozzia service department.

PRODUCT CARE AND STORAGE

1. Storing the Massage Chair

- Wipe off dust and dirt from the massage chair with a dry, soft, clean cloth after use.
- Keep the massage chair clean and away from places of high humidity.
- If the massage chair is not to be used for a long period of time, cover the massage chair with a dust cover and unplug its power plug from the electrical outlet.

⚠ Caution

- Do not store the massage chair in direct sunlight or in places of high temperature. This may cause the color of the upholstery to fade.
- Do not allow the massage chair to remain in contact with vinyl or wallpaper for extended periods of time as this could lead to discoloration.

2. Cleaning the Massage Chair

- Before cleaning, ensure that the main power switch is off and the power plug is disconnected from the electrical outlet.
- Wipe off dust and dirt from the massage chair with a dry, soft, clean cloth after each use.
- This product can be cleaned thoroughly with a slightly damp cloth.
- Do not iron the upholstery.
- Do not wash the upholstery using a home washing machine as this may result in deterioration of the upholstery's quality.

⚠ Caution

- Do not use abrasive cleaning agents like benzene or thinner to clean the massage chair. This may cause the upholstery to fade.

3. Cleaning the Controller

- Use only a clean, dry cloth to clean the controller.

⚠ Caution

- Do not use a wet cloth to clean the controller. This may result in malfunction.

COZZIA CONSUMER WARRANTY

This Cozzia product has the following warranty:

The Cozzia Bliss ProFlex has a one-year in-home service and two-year parts warranty. Cozzia customer service will not issue Return Material Authorizations (RMAs) for products. Cozzia products will be either repaired by the consumer or by an in-home technician. Cozzia will not issue Return Material Authorizations (RMAs) for buyer's remorse.

Service And Technical Support

Consumers may contact Cozzia's customer service department at 1-877-977-0656 between 9:00 am and 5:30 pm PST, Monday through Friday, email us at Service@cozziausa.com, or visit our website at www.cozzia.com for warranty or service issues.

Consumers are required to provide the unit serial number and dated proof of purchase (sales receipt) when they contact the Cozzia service department regarding a repair.

A Cozzia customer service representative will attend to most consumer inquiries, but in some cases a technical service specialist will provide advanced support.

Non-warranty repair is provided on a "per incident" basis. Cozzia customer service will verify that the unit has failed and provide instructions for repairing the unit. All applicable repairs, parts, shipping, handling, local tax and a "per incident" fee will be charged for non-warranty repairs and support calls.

Proof of purchase (original receipt) is required for all warranty repairs or service.

Extended Warranties:

Cozzia offers extended warranty programs to enhance the ownership of your massage chair. Please call Cozzia customer service at 877-977-0656 for details and pricing.

Product Repairs

- Floor Models and Demonstration Units have a prorated warranty period that begins the day the model is placed on the floor and connected to an electrical outlet by the retail partner. Proof of purchase is required in order to obtain warranty service and parts. Non-warranty parts and service are available at a "per incident" charge.
- Warranty Coverage Period - Warranty coverage starts at the time that the consumer PURCHASES their chair. Proof of purchase is required for all warranty repairs. The warranty time period is measured by continuous calendar days based on a seven-day week.
- Field Service - Cozzia customer service department will diagnose and schedule an authorized service provider to repair the chair in the consumer's residence.

- Parts - All parts deemed necessary for repairs will be shipped to the consumer at no charge by the Cozzia service department. Some Cozzia product repairs may be performed by the consumer in their own home with parts and instructions supplied by Cozzia, such as remote controller replacements that don't require a technician.

CONSUMER WARRANTY LIMITATIONS AND EXCLUSIONS

- Warranties are only valid in the 48 contiguous United States and Canada and are contingent upon the consumer operating the chair according to the corresponding instruction manual.
 - The warranty only applies to Cozzia products and does not include any accessories or enhancements.
 - Field service requires pre-approval and must be performed by Cozzia's authorized field service personnel.
 - Field service is only available in the United States and in major metropolitan areas in Canada.
 - Softening of foams and filling composites in pillows, pads, and memory foam occurs naturally and does not constitute a defect under this warranty.
 - Fading, wear and piling of fabrics occurs naturally and does not constitute a defect under this warranty.
 - Warranties do not cover any loss or damage resulting from improper installation, unauthorized repairs or modifications, improper use of electrical/power supply, loss of power, dropped product, a malfunction or damage of an operating part from failure to provide manufacturer's recommended maintenance, transportation damage, theft, abuse, misuse, neglect, vandalism or environmental conditions (fire, floods, rust, corrosion, sand, dirt, windstorm, hail, earthquake or exposure to weather conditions).
 - Warranties do not cover any loss during the time spent waiting for parts or repairs.
 - Damage due to shipping and handling does not constitute a defect under this warranty.
 - Under no circumstance shall Cozzia or its representatives be liable for indirect, consequential, or incidental damages (including damages for lost profits, business interruption, bodily injury, medical and the like).
 - Warranties are non-transferable.
 - Cozzia's sole liability and the purchaser's exclusive remedy shall be for the repair, or at Cozzia's option, for the replacement of the defective part.
 - Notwithstanding the above, if replacement parts for defective materials are not available, Cozzia reserves the right to make substitutions in lieu of repair or replacement.
-
- All warranties begin on the DATE OF PURCHASE; no allowance or extension is offered for delivery and/or installation.
 - Warranties do not apply to rental, business, commercial, institutional or other non-residential users.

DIMENSIONS

First, let's get your chair inside.

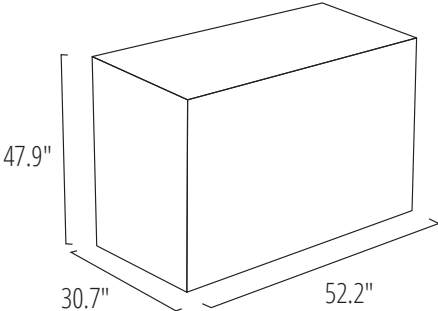
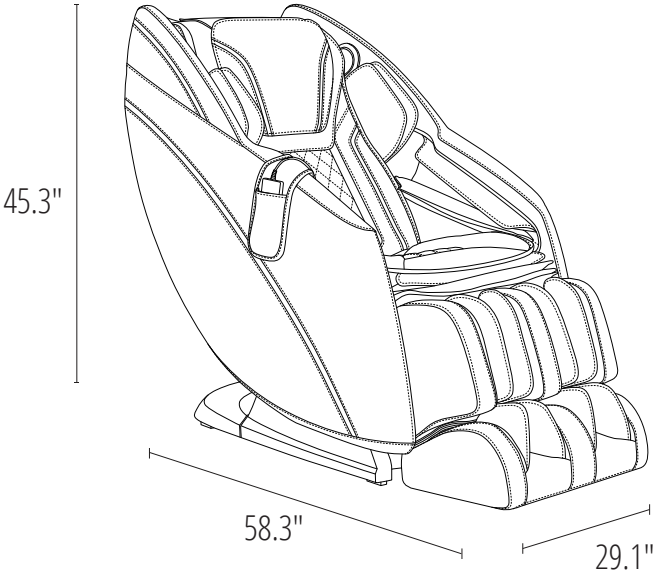

Master Carton

CONTENTS

Everything you need for a relaxing experience.



User Manual



Installation Manual

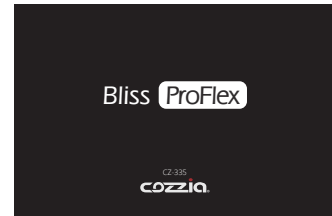

Warranty Postcard

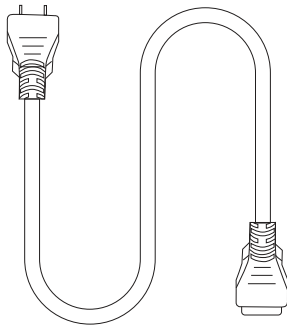

Power Cord



Remote Control

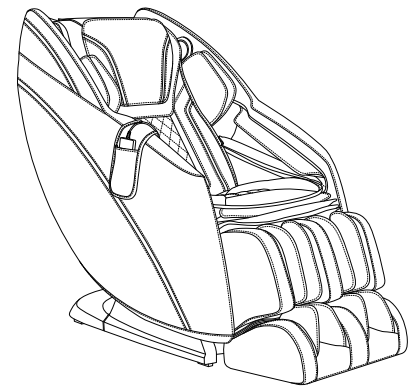

Bliss ProFlex Massage Chair

MOVE & CLEARANCE

A few simple steps to find the best place for your new chair.

HOW TO MOVE

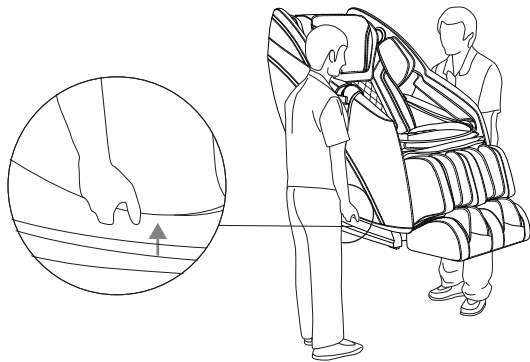

Lift and hold the bottom of the chair

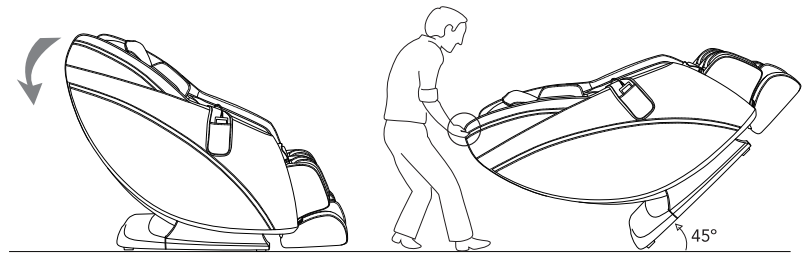

Tilt the backrest down 45 degrees onto the rear castor wheels

CLEARANCE

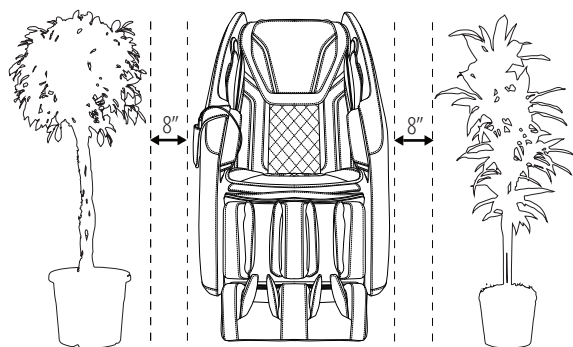

Reserve space on the left and right

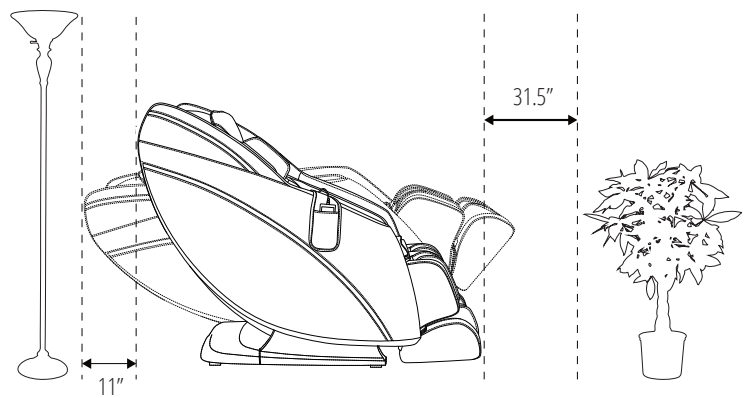

Reserve space on the front and back

CHAIR COMPONENTS

Some of your chair's most important features.

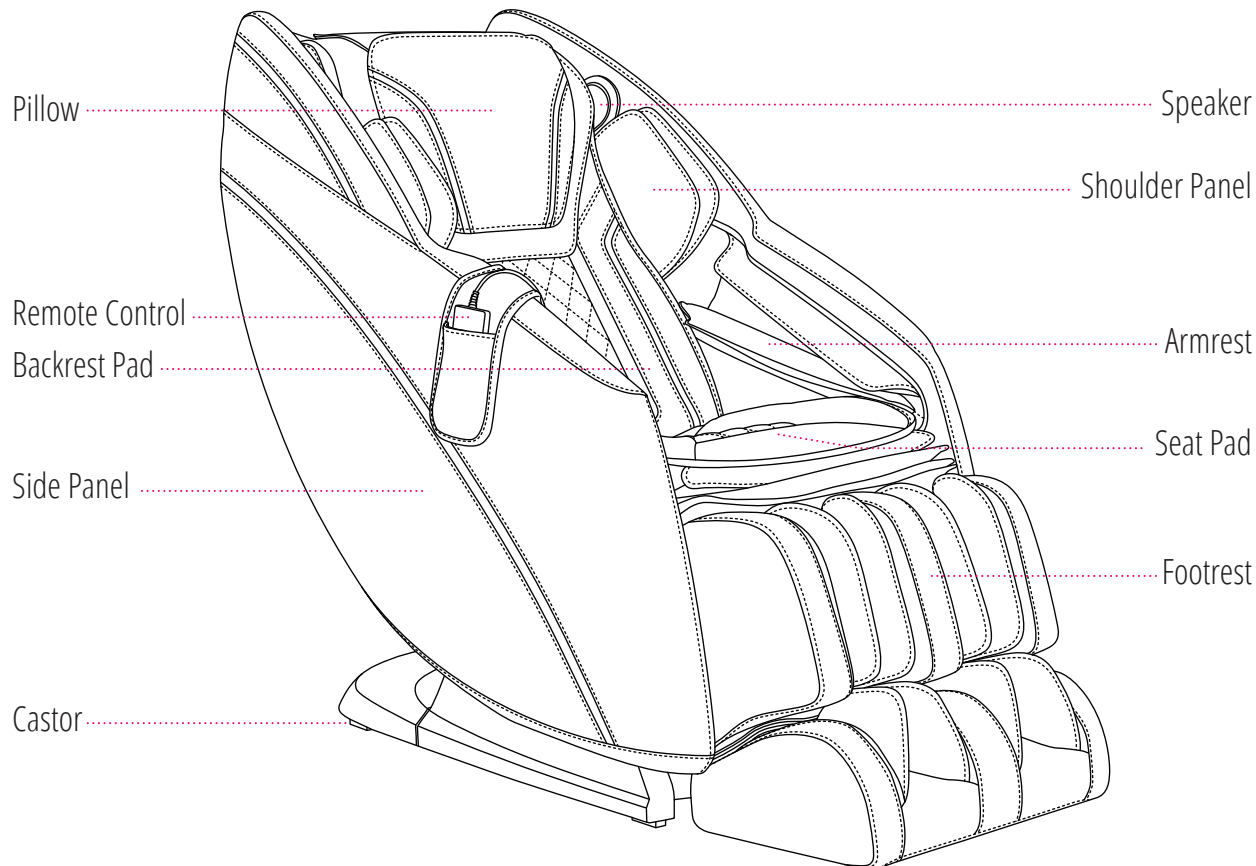

Note: The speaker will only operate when the massage chair is in operation



To play music using your massage chair's speakers, please connect your smartphone, tablet, or other electronic device to your chair using bluetooth. Note that the code to connect the bluetooth is "Bliss ProFlex".

MASSAGE POINTS

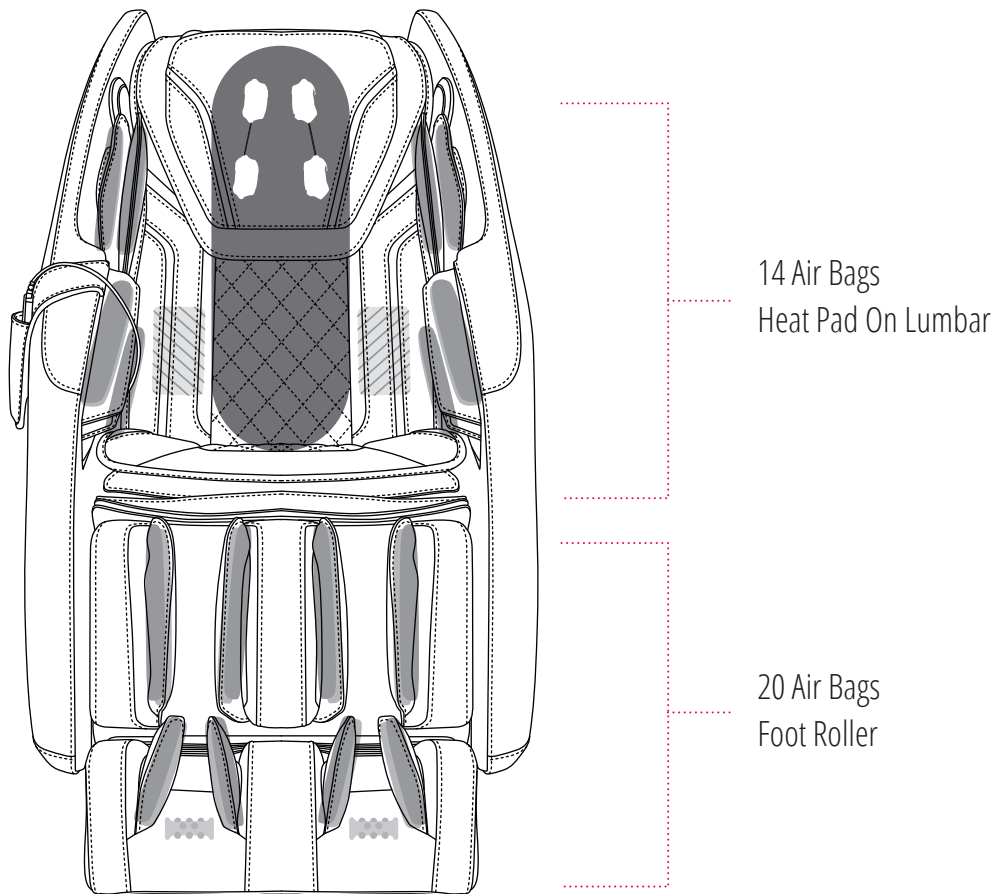

●
Back Massage Mode

●
Air Bags

●●●●
Rollers

●
Heating Pads

CHAIR SPECIFICATIONS

A few important facts about your massage chair.



Model No.

CZ-335
Bliss ProFlex

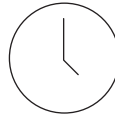

Massage Time

5 to 30 minutes

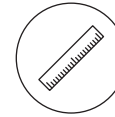

Dimensions (L x W x H)

Chair dimensions: 58.3" x 29.1" x 45.3"
Reclined dimensions: 68.9" x 29.1" x 37.4"



Shipping Weight

Gross weight: 205 lbs
Net weight: 172 lbs

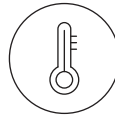

Usage Condition

Environment temperature: 32°F – 104°F
Contrasting humidity: 30-85RH



Storage Condition

Storage temperature: 23°F – 95°F
Storage humidity level: 30-85RH



Rated Current

1.45A



Rated Voltage

110 - 120V



Rated Frequency

60Hz



Power of Speakers

3W x 2

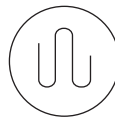

Length of Wiring

Power supply wiring: 70.9"
Controller wiring: 39.4"



Safety Feature

Equipped with child safety lock,
backrest safety sensor,
and overheating and power surge detectors

HOW TO USE

Connect the chair to a power supply, then turn switch to the “I” position. The chair is now in idle mode.



1. “” ON/OFF

Press this button to light up the LCD screen. Press any massage function button to start massage. This will initiate the timer function. Press this button again to stop all massage functions, massage chair will return to its original position.

2. “” HOME PAGE

Press this button once to return to home page.

3. “” “” CHAIR ANGLE ADJUSTMENT

Press and hold to adjust chair position.

4. “” FAVORITES

Go to favorites page.

5. “” PAUSE

Press this button once to halt current massage function and count down timer. Press this button again to cease the “Pause” function and resume previous massage function as well as countdown timer.

6. “” RETURN

Press this button once during operation to return to the previous chosen interface.

7/8/9/10. “” DIRECTIONAL BUTTONS

Use the up, down, left and right arrow buttons to move around the options menu and select your desired functions.

11. “OK” OK

During selection, press down this button to start the massage or enter into next selection interface.

12. “” MESSAGE TIMER ADJUSTMENT

Adjust the massage time for the current program.

Home Page

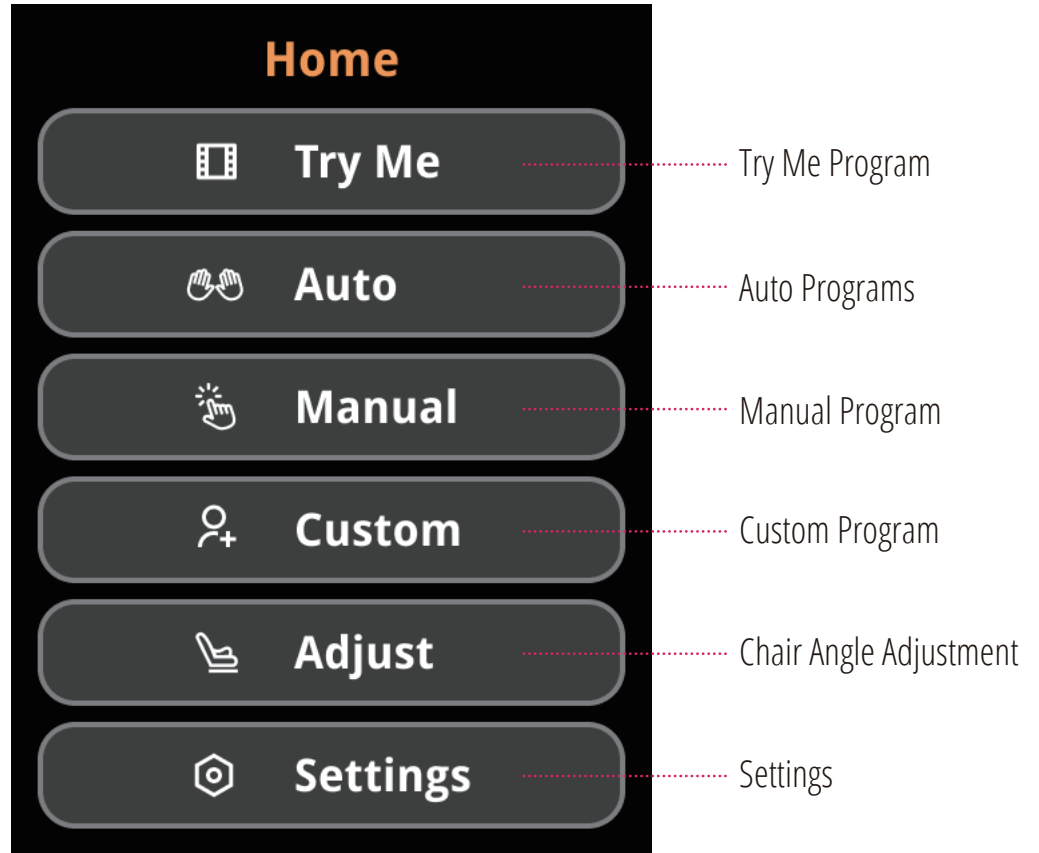

Select the function using the arrow buttons, then press the "OK" button to confirm

Try Me Interface

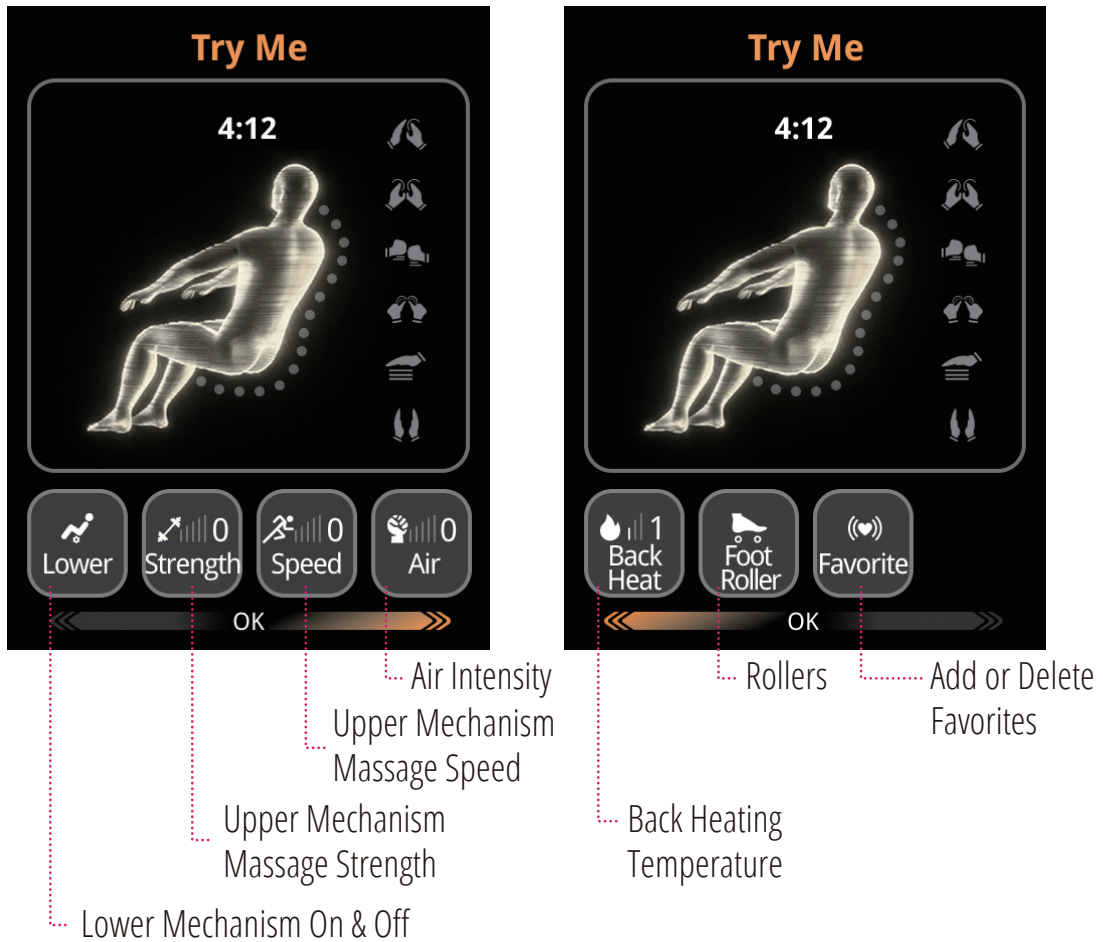

Select the function using the arrow buttons, then press the "OK" button to confirm

Auto Massage Interface

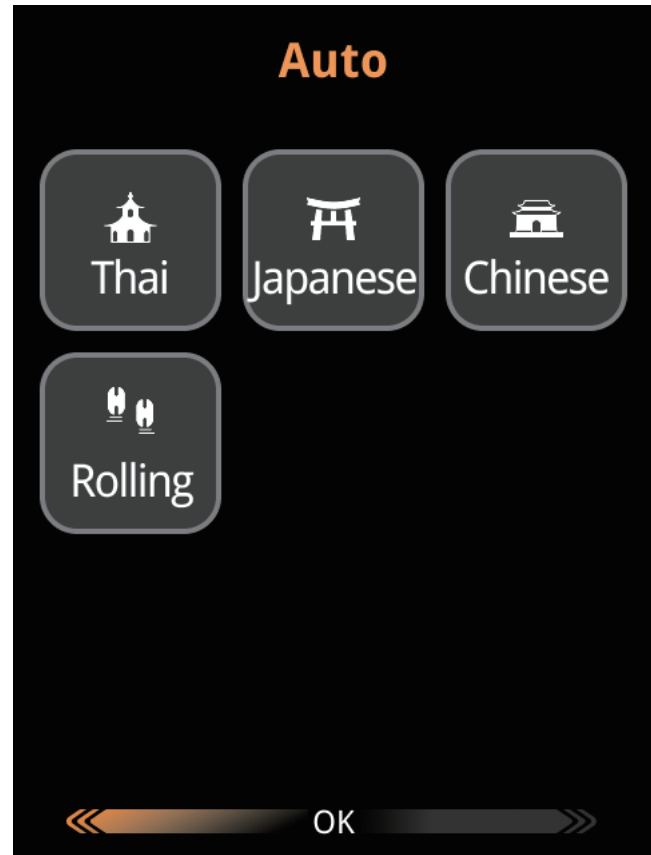
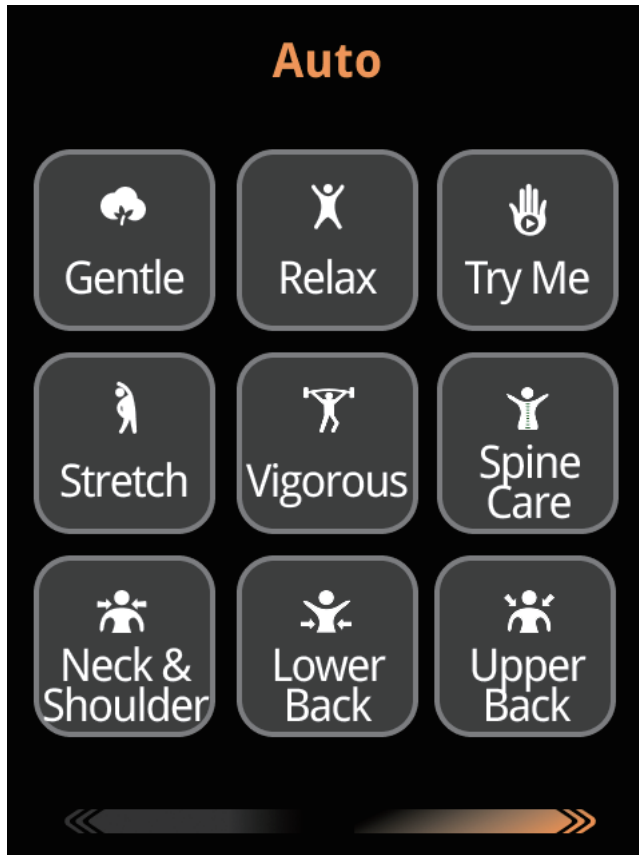

Select one of the 13 automatic program icons and press the "OK" button to start the massage
(Gentle, Relax, Try Me, Stretch, Vigorous, Spine Care, Neck&Shoulder, Lower Back, Upper Back, Thai, Japanese, Chinese, Rolling)

Manual Massage Interface 1

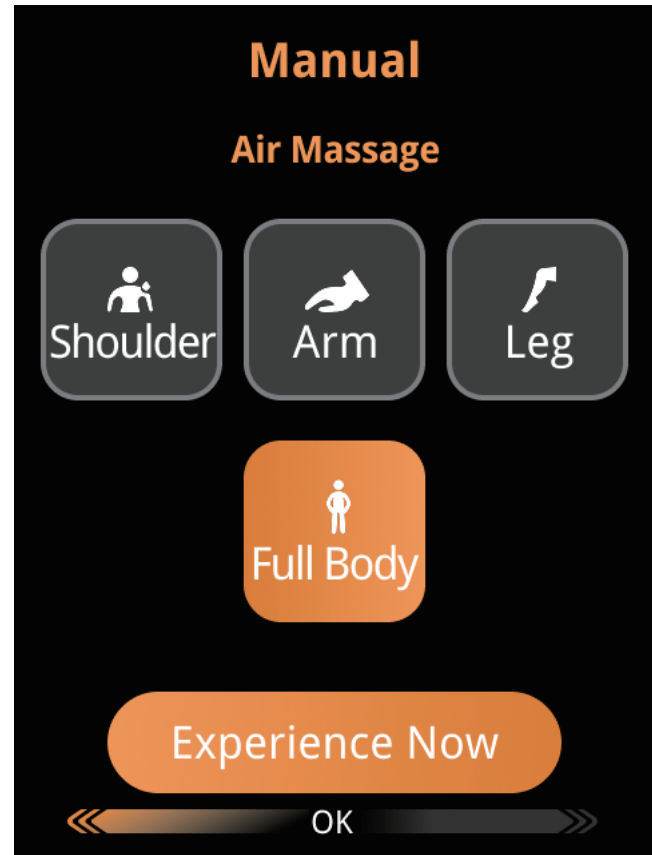
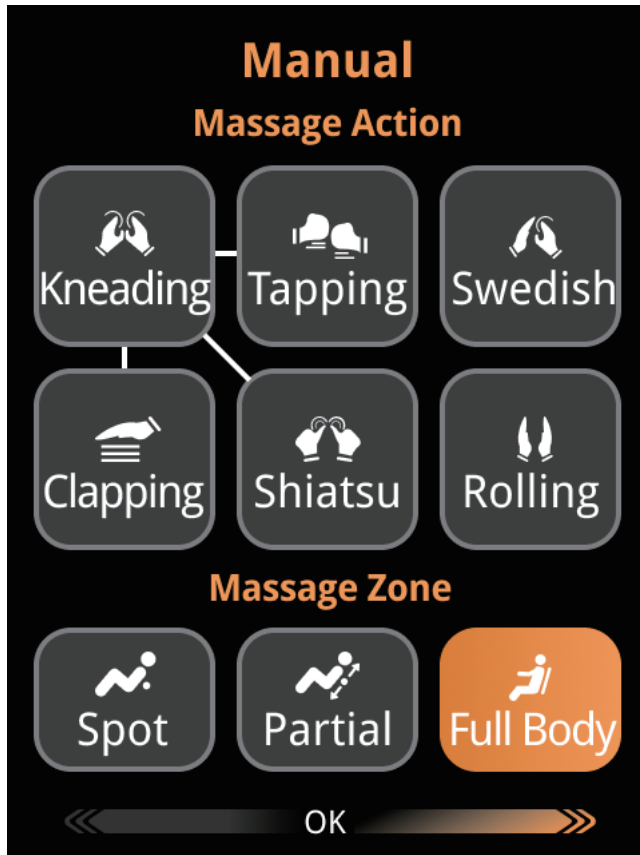

Select the massage action icon and massage area using the arrow buttons and press the "OK" button once to confirm

Select the air massage area using the arrow buttons, press the "Experience Now" button to start the massage

Manual Massage Interface 2

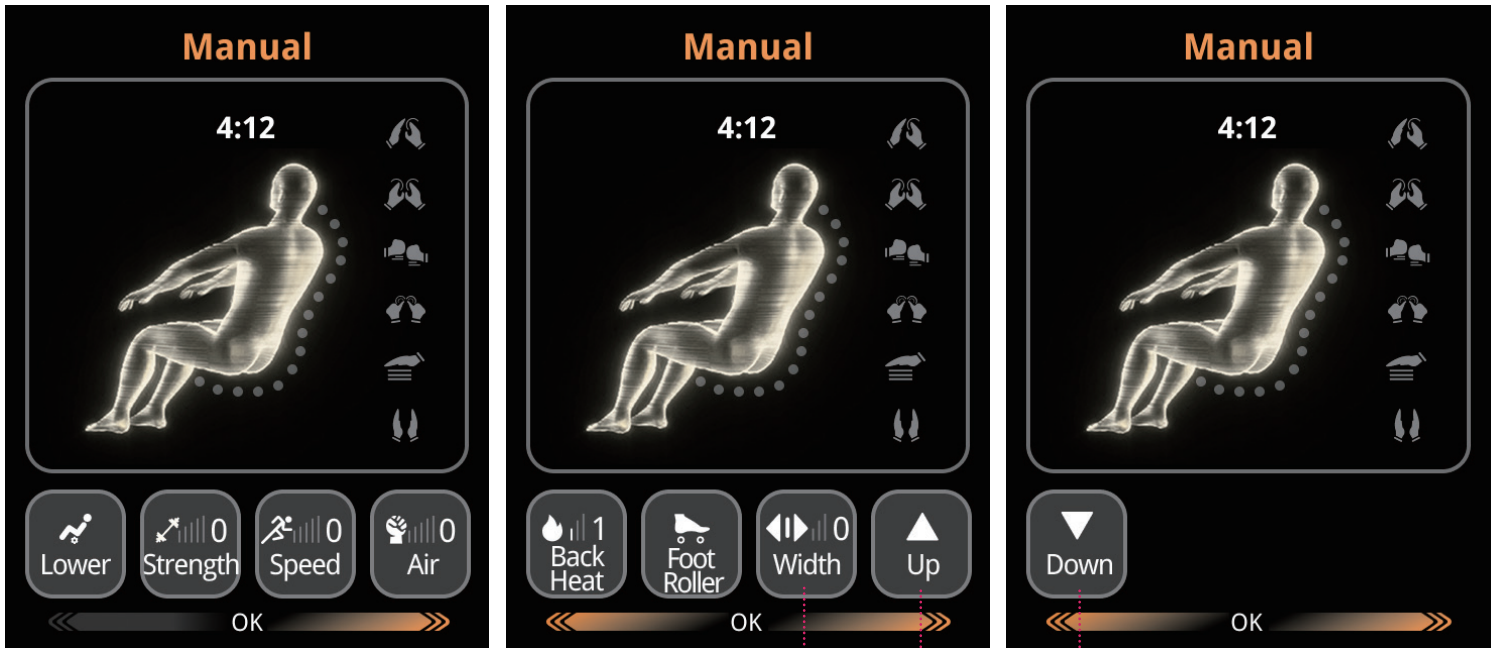

Massage Width

Move Rollers Up

Move Rollers Down

Select the function using the arrow buttons, then press the "OK" button to confirm

Custom Massage Interface 1

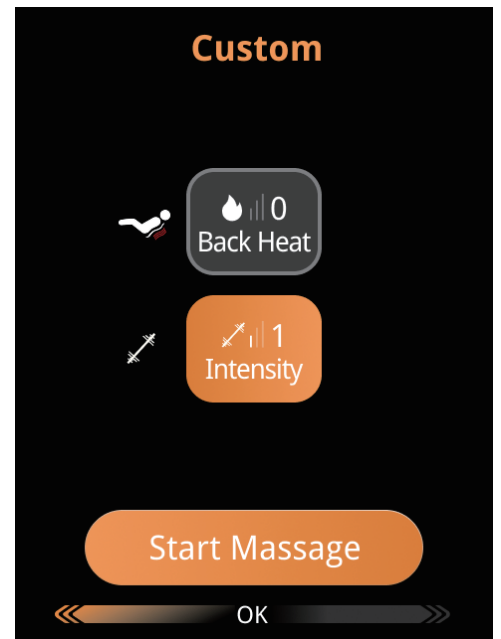
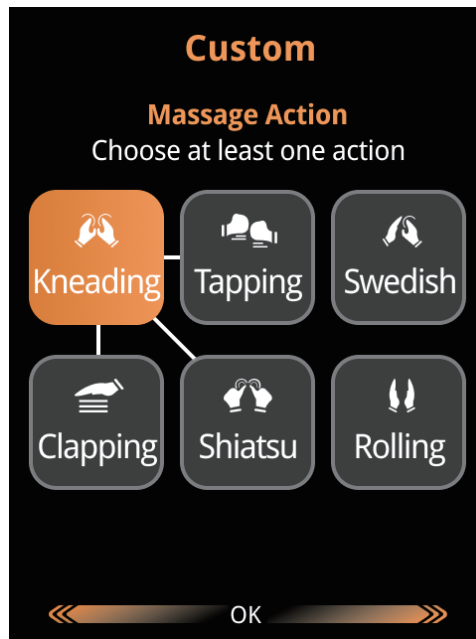
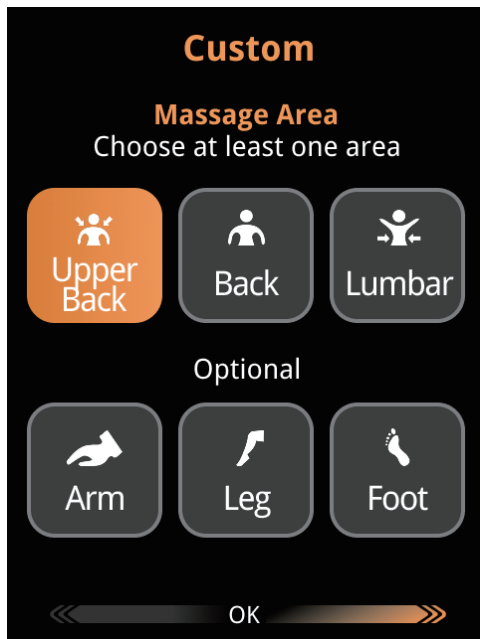

Select the massage action icon and massage area using the arrow buttons and press the "OK" button once to confirm

Select the heat temperature and massage strength using the arrow buttons, and press the "Start Massage" button to start the massage

Custom Massage Interface 2

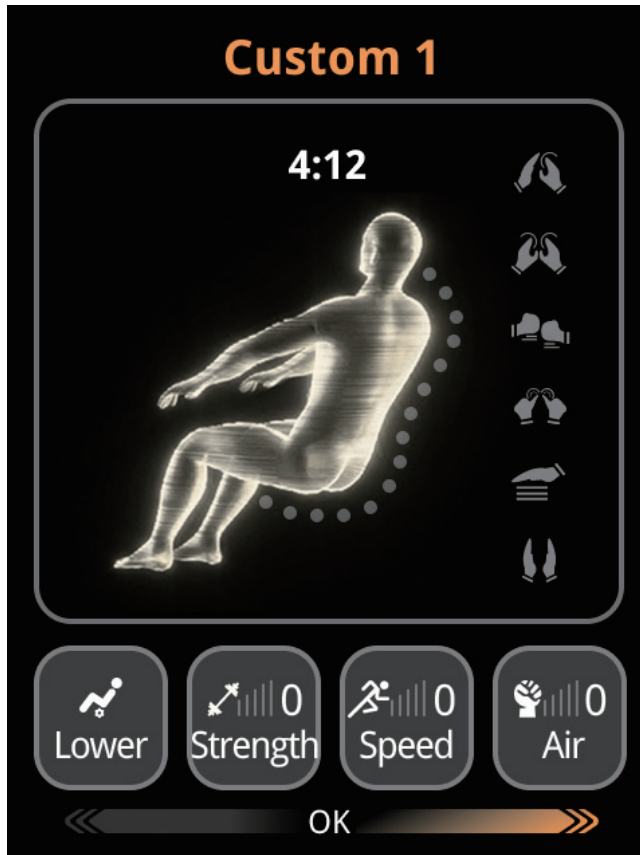

Press the "Favorite" button to save the massage program

Press the "Edit" button to edit the current program

Chair Position Adjustment Interface

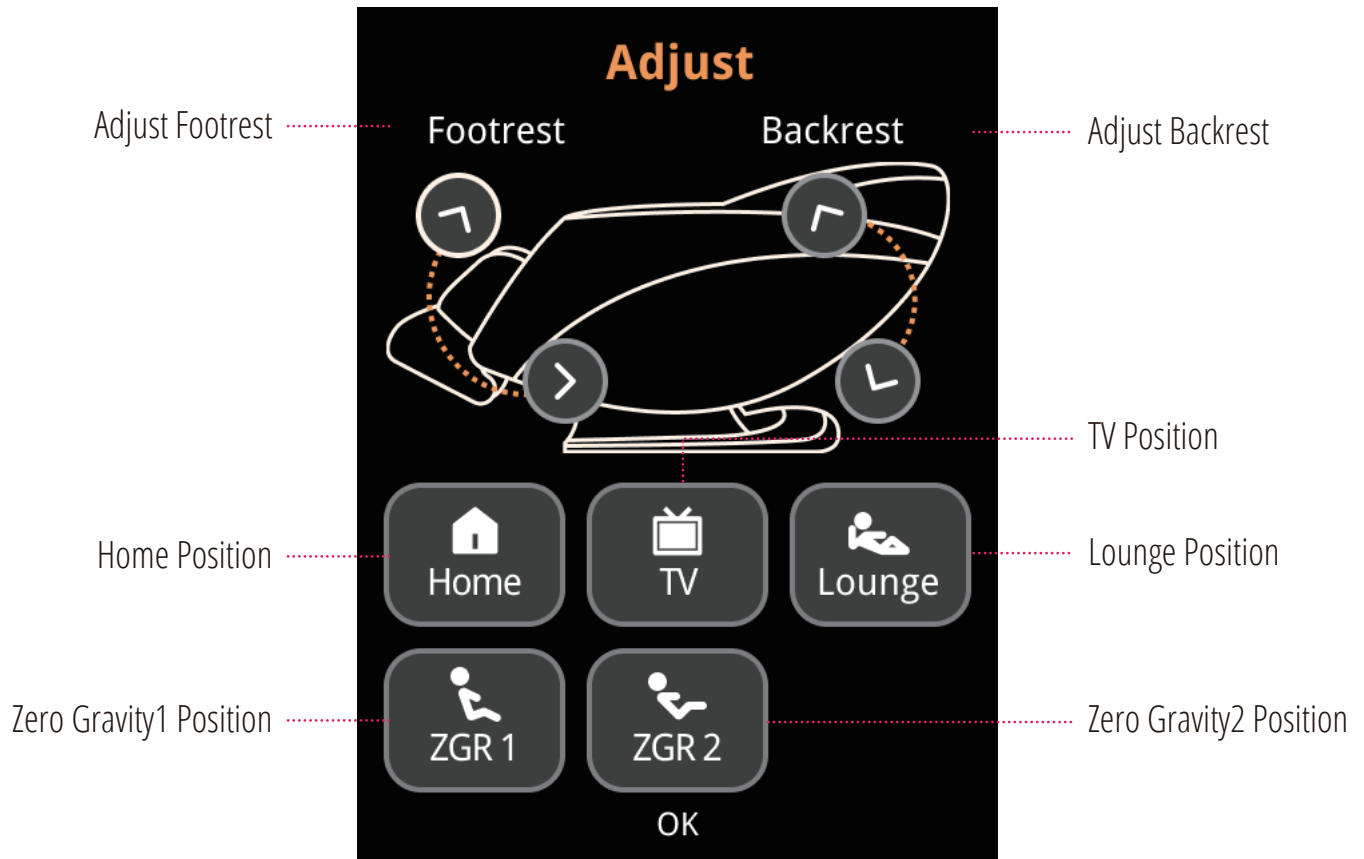

Select the arrow button, press and hold "OK" to adjust the footrest and backrest

Select the zero gravity icon using the arrow buttons and press the "OK" button to confirm

Settings Interface 1

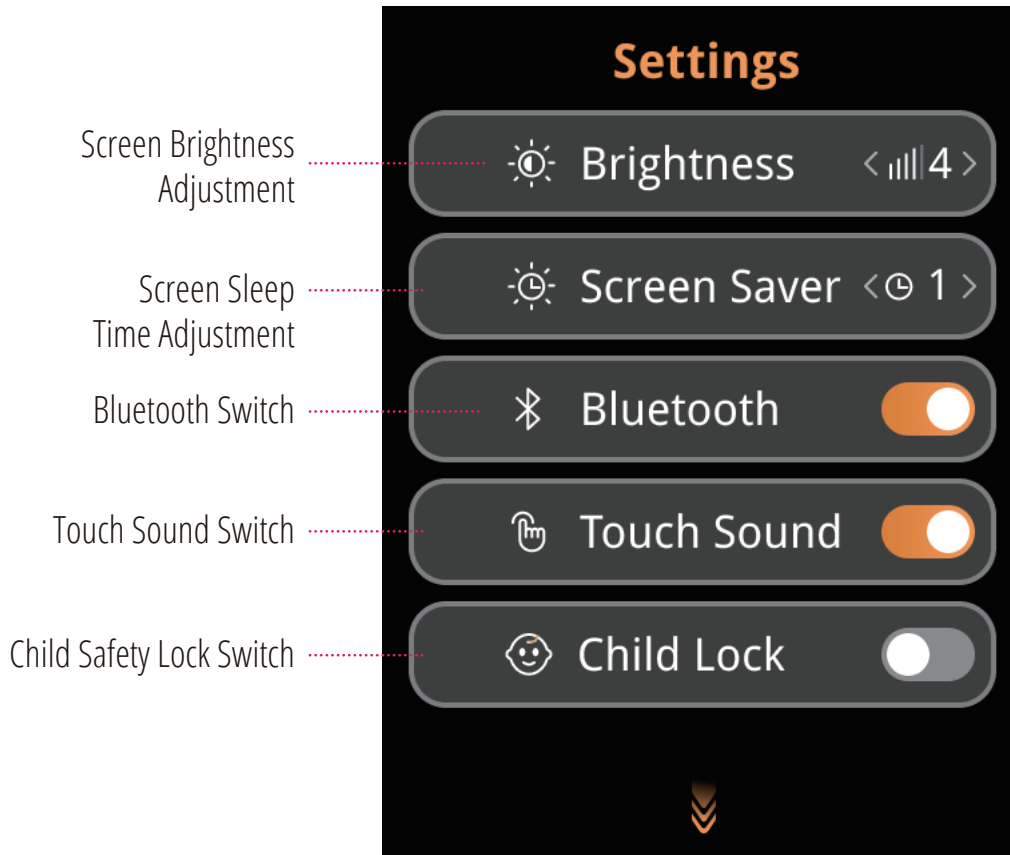

Use the up and down arrow buttons to adjust the corresponding functions

Settings Interface 2

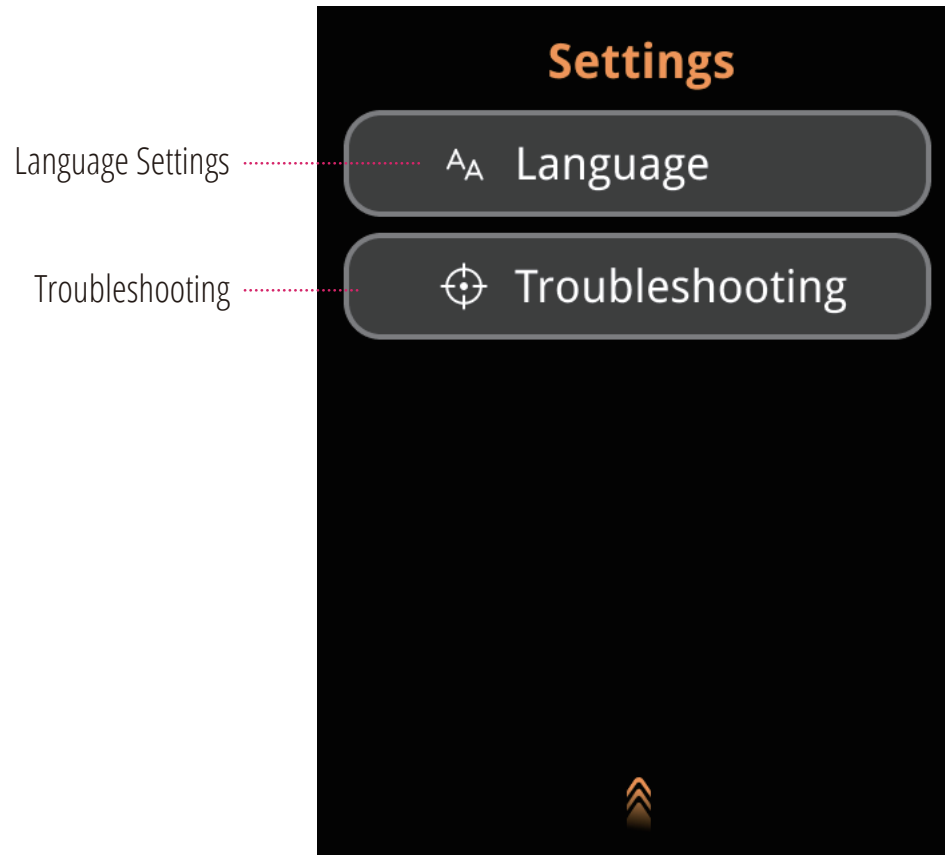

Use the up and down arrow buttons to adjust the corresponding functions

Child Safety Lock

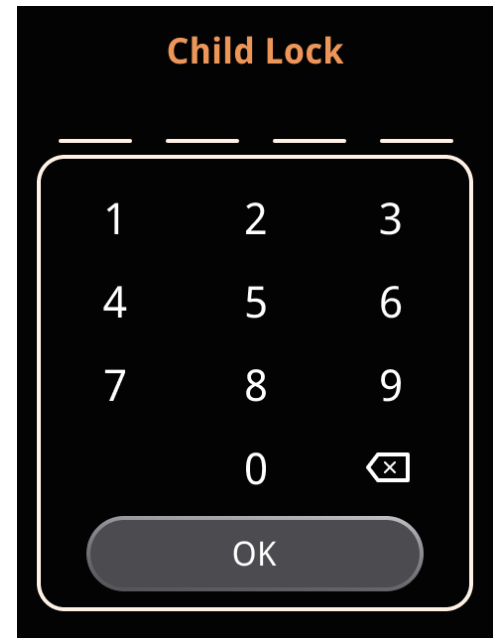
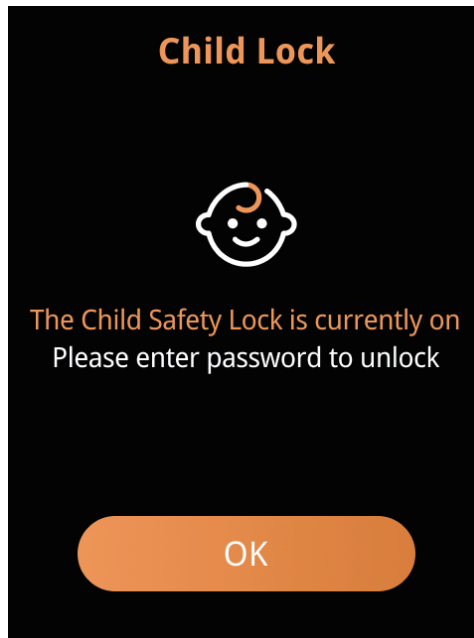
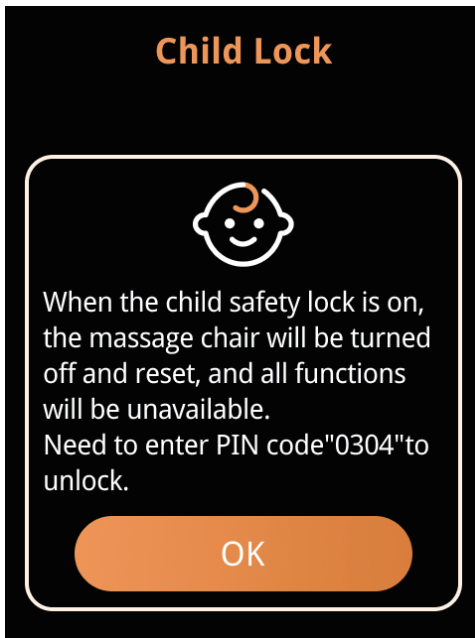

Please enter the password "0304" to unlock your massage chair

If you don't need the Child Safety Lock on anymore, go to the Settings page to turn off this function

Language Interface



Select the language using the arrow buttons, then press the "OK" button to confirm

Troubleshooting Interface 1



Press the "OK" button to enter into the troubleshoot detection program



Scanning takes 90 seconds

Troubleshooting Interface 2



Press the "OK" button to enlarge the QR code to view



Press the "OK" button to shrink the QR code back to normal size

Favorites

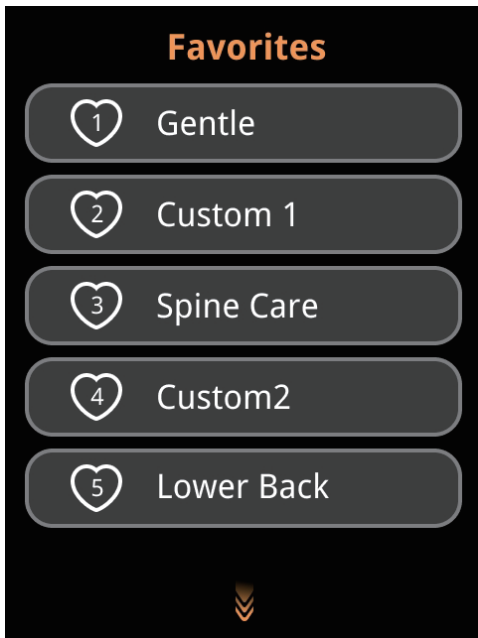

Here are the favorite programs

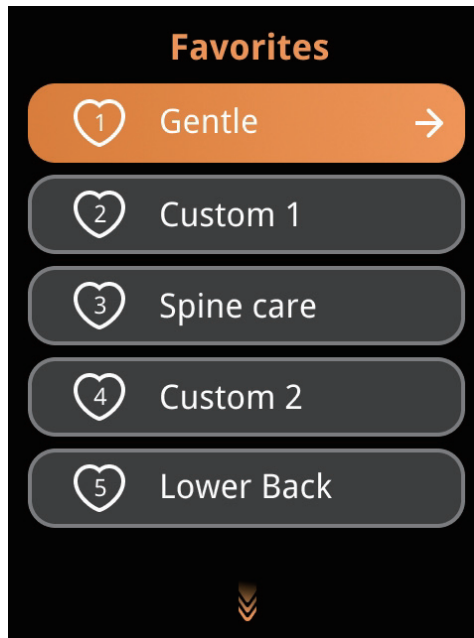

Press the "OK" button to enter into the message program

Press the right button to go to the page to delete a favorite program

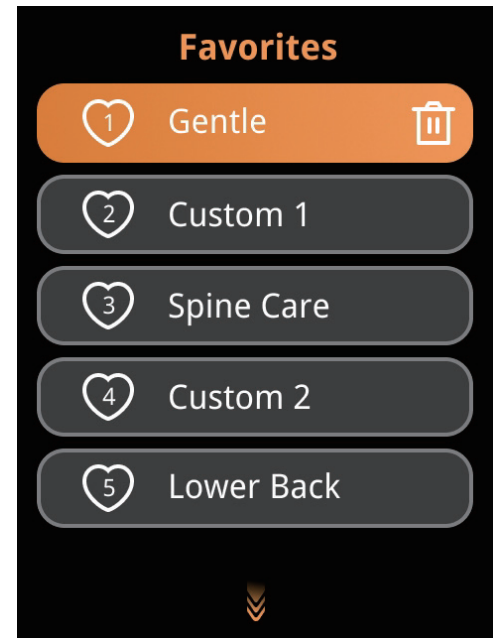

Press the "OK" button to delete the message program from your favorites

Select the function using the arrow buttons, then press the "OK" button to confirm

AUTO PROGRAM DESCRIPTIONS

Let's dig a little deeper and discover the details of our pre-programmed massages.

Try Me



A 5 minute whole body massage for those on the go.

FOCUS AREAS

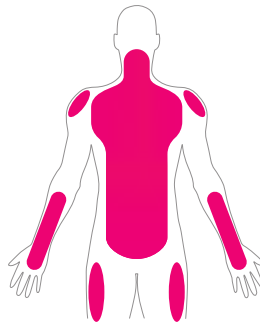

INTENSITY



FOCUS TECHNIQUES



KNEADING ROLLING TAPPING

Gentle



A program designed to provide a quiet, gentle massage that is good for beginners or those that prefer a soft touch.

FOCUS AREAS

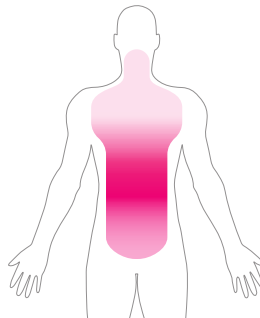

INTENSITY



FOCUS TECHNIQUES



KNEADING ROLLING

Stretch



This massage will stretch your legs and back with a combination of gentle tapping, rolling, and air compression.

FOCUS AREAS

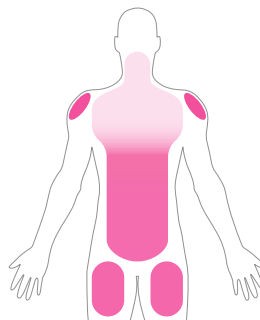

INTENSITY



FOCUS TECHNIQUES



KNEADING TAPPING

Spine Care



This program provides a deep tissue massage that relaxes the spine.

FOCUS AREAS

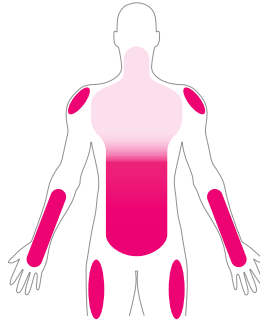

INTENSITY



FOCUS TECHNIQUES



SHIATSU SWEDISH

Rolling

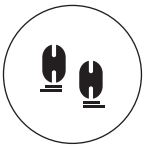

This program will massage from your neck down to your hips, using the ultra rolling technique.

FOCUS AREAS

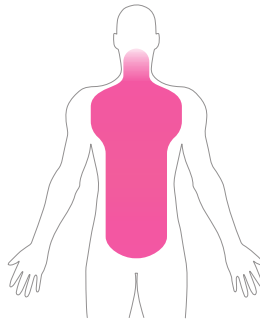

INTENSITY



FOCUS TECHNIQUES



ROLLING

Relax

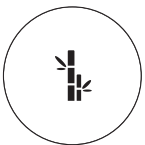

A program designed to provide a mild massage that is great for deep relaxation, best used before going to sleep.

FOCUS AREAS

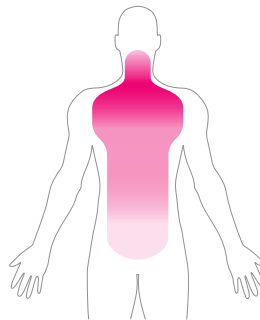

INTENSITY



FOCUS TECHNIQUES



KNEADING SWEDISH

Vigorous



This massage will combine vigorous tapping on your lower back and an air massage focused on your thighs and legs.

FOCUS AREAS

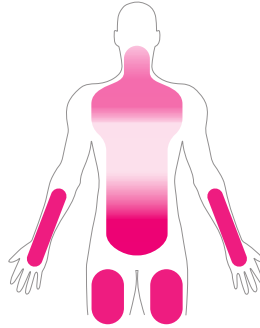

INTENSITY



FOCUS TECHNIQUES



TAPPING KNEADING

Neck & Shoulder



This massage will focus on your shoulders and neck using a combination of kneading and shiatsu techniques.

FOCUS AREAS

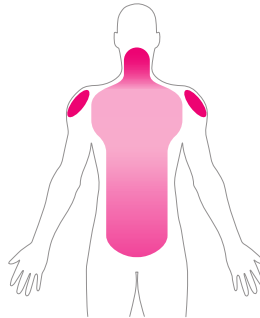

INTENSITY



FOCUS TECHNIQUES



KNEADING TAPPING

Lower Back



This massage will focus on your lower back with a deep massage that includes air compression.

FOCUS AREAS

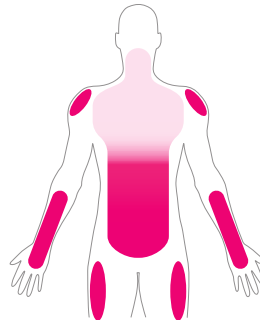

INTENSITY



FOCUS TECHNIQUES



TAPPING KNEADING

Upper Back



This massage will focus on your neck, shoulders, and legs with a slow massage that incorporates soothing heat.

FOCUS AREAS

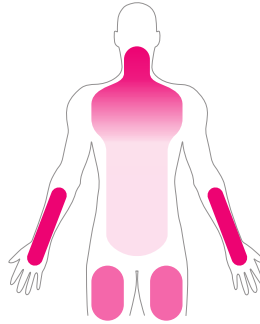

INTENSITY



FOCUS TECHNIQUES



KNEADING TAPPING SWEDISH

Japanese



A program designed using Japanese-inspired techniques to improve your immune system, blood circulation, and aid in pain relief.

FOCUS AREAS

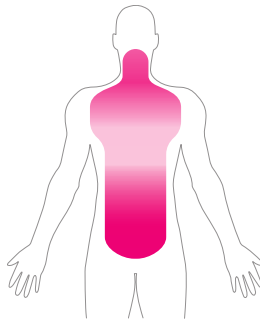

INTENSITY



FOCUS TECHNIQUES



SHIATSU KNEADING

Chinese



This massage will focus on your entire back while also massaging your legs and feet.

FOCUS AREAS

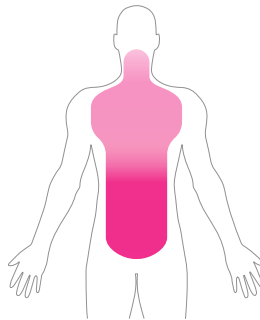

INTENSITY



FOCUS TECHNIQUES



KNEADING TAPPING

Thai



This massage will focus on your mid back and upper shoulders with a deep tissue massage that will create an acupressure effect.

FOCUS AREAS

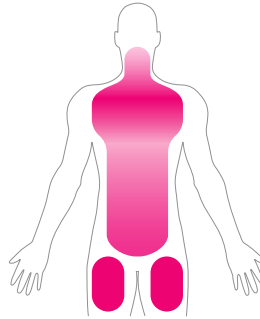

INTENSITY



FOCUS TECHNIQUES



KNEADING TAPPING



861 S. Oak Park Road,
Covina, CA 91724

TEL: 1-877-977-0656
FAX: 1-800-521-4712
SERVICE@COZZIAUSA.COM

WWW.COZZIA.COM