

SAMSUNG

USER GUIDE

HW-QS90H / HW-QS95H
HW-QS95GH

To receive more complete service, please register your product at www.samsung.com

Figures and illustrations in this User Manual are provided for reference only and may differ from actual product appearance.

Contents

01 Safety Information	3	07 Connecting an External Device	13
SAFETY WARNINGS	3	Connecting by HDMI Cable	13
Important Safety Instructions	3	Connecting using an Optical Cable	14
Precautions	4	08 Connecting a Mobile Device	14
02 Checking the Components	4	Connecting by Bluetooth	14
03 Product Overview	5	Connecting by Wi-Fi (Wireless Network)	15
Front side	5	Using Group Play	16
Rear side	5	Connecting to Apple AirPlay®	16
04 Using the Remote Control	6	09 Installing the Soundbar on a Wall	16
How to use the Remote Control	6	Precautions when installing	16
Setting the  (Sound Control)	8	Wall Mount Components	16
Output specifications for each sound mode	8	10 Installing the Soundbar on top of the TV Stand	18
- For using the soundbar	8	Components	18
- For using the surround speaker (SWA-9500S, optional) together	8	11 Software Update	18
Adjusting the Soundbar Volume with the TV Remote Control	9	Automatic update	18
05 Connecting the Soundbar to Other Units	9	USB update	18
Connecting the Power and Devices	9	Reset	19
Connecting an Samsung Wireless Rear Speaker Kit (Sold Separately) to your Soundbar	9	Security updates information	19
06 Connecting to a TV	10	12 Troubleshooting	19
Connect to a TV that supports HDMI ARC (Audio Return Channel)	10	13 Licenses & Other Information	21
Connecting Using an Optical Cable	10		
Connecting by Bluetooth	11		
Connecting by Wi-Fi (Wireless Network)	12		
Using the Q-Symphony Feature	12		
Using SpaceFit Sound Pro	13		

01 Safety Information









The following also applies to the Subwoofer and Surround Speaker SET.

SAFETY WARNINGS

TO REDUCE THE RISK OF ELECTRIC SHOCK, DO NOT REMOVE THE COVER (OR BACK).

NO USER-SERVICEABLE PARTS ARE INSIDE. REFER SERVICING TO QUALIFIED SERVICE PERSONNEL.

Refer to the table below for an explanation of symbols which may be on your Samsung product.

	CAUTION RISK OF ELECTRIC SHOCK. DO NOT OPEN.	
	This symbol indicates that high voltage is present inside. It is dangerous to make any kind of contact with any internal part of this product.	
	This symbol indicates that this product has included important literature concerning operation and maintenance.	
	Class II product : This symbol indicates that a safety connection to electrical earth (ground) is not required. If this symbol is not present on a product with a power cord, the product MUST have a reliable connection to protective earth (ground).	
	AC voltage : Rated voltage marked with this symbol is AC voltage.	
	DC voltage : Rated voltage marked with this symbol is DC voltage.	
	Caution. Consult Instructions for use : This symbol instructs the user to consult the user manual for further safety related information.	

WARNING

- To reduce the risk of fire or electric shock, do not expose this appliance to rain or moisture.
- To prevent injury, this apparatus must be securely attached to the floor/wall in accordance with the installation instructions.
- This product contains chemicals known to the State of California to cause cancer and birth defects or other reproductive harm.
- Do not use liquid fumigators containing chemicals, such as mosquito repellent or air freshener, around the product. If steam comes in contact with the product surface or enters the product, it may cause stains or malfunction.
- For crevices or other areas that cannot be thoroughly cleaned with a cloth, use a soft cotton swab, brush, or air blower to remove dirt.

CAUTION

- Do not expose this apparatus to dripping or splashing. Do not put objects filled with liquids, such as vases, on the apparatus.
- To turn this apparatus off completely, you must pull the power plug out of the wall socket. Consequently, the power plug must be easily and readily accessible at all times.

Important Safety Instructions

Read these operating instructions carefully before using the unit. Follow all the safety instructions listed below. Keep these operating instructions handy for future reference.

1. Read these instructions.
2. Keep these Instructions.
3. Heed all warnings.
4. Follow all instructions.
5. Do not use this apparatus near water.
6. Clean only with dry cloth.
7. Do not block any ventilation openings.
Install in accordance with the manufacturer's instructions.
8. Do not install near any heat sources such as radiators, heat registers, stoves, or other apparatus (including amplifiers) that produce heat.
9. Do not hinder in any way the safety purpose of the polarized or grounding-type plug.
A polarized plug has two blades with one wider than the other. A grounding type plug has two blades and a third grounding prong. The wide blade or the third prong are provided for your safety. If the provided plug does not fit into your outlet, consult an electrician for replacement of the obsolete outlet.
10. Protect the power cord from being walked on or pinched particularly at plugs, convenience receptacles, and the point where they exit from the apparatus.
11. Only use attachments/accessories specified by the manufacturer.
12. Use only with the cart, stand, tripod, bracket, or table specified by the manufacturer, or sold with the apparatus. When a cart is used, use caution when moving the cart/apparatus combination to avoid injury from tip-over.



13. Unplug this apparatus during lightning storms or when unused for long periods of time.
14. Refer all servicing to qualified service personnel. Servicing is required when the apparatus has been damaged in any way, such as power-supply cord or plug is damaged, liquid has been spilled or objects have fallen into the apparatus, the apparatus has been exposed to rain or moisture, does not operate normally, or has been dropped.

Precautions

1. Ensure that the AC power supply in your house complies with the power requirements listed on the identification sticker located on the bottom of your product. Install your product horizontally, on a suitable base (furniture), with enough space around it for ventilation (3~4 inches). Make sure the ventilation slots are not covered. Do not place the unit on amplifiers or other equipment which may become hot. This unit is designed for continuous use. To fully turn off the unit, disconnect the AC plug from the wall outlet. Unplug the unit if you intend to leave it unused for a long period of time.
2. During thunderstorms, disconnect the AC plug from the wall outlet. Voltage peaks due to lightning could damage the unit.
3. Do not expose the unit to direct sunlight or other heat sources. This could lead to overheating and cause the unit to malfunction.
4. Protect the product from moisture (i.e. vases), and excess heat (e.g. a fireplace) or equipment creating strong magnetic or electric fields. Unplug the power cable from the AC wall socket if the unit malfunctions. Your product is not intended for industrial use. It is for personal use only. Condensation may occur if your product has been stored in cold temperatures. If transporting the unit during the winter, wait approximately 2 hours until the unit has reached room temperature before using.
5. The battery used with this product contains chemicals that are harmful to the environment. Do not dispose of the battery in the general household trash. Do not expose the battery to excess heat, direct sunlight, or fire. Do not short circuit, disassemble, or overheat the battery.
CAUTION : Danger of explosion if the battery is replaced incorrectly. Replace only with the same or equivalent type.

02 Checking the Components

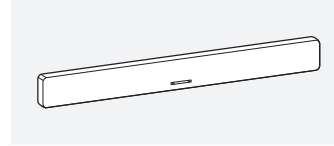

Soundbar

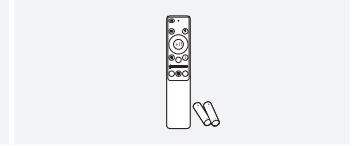

Remote Control (AH81-15047A) / Battery (May not be provided in some regions)

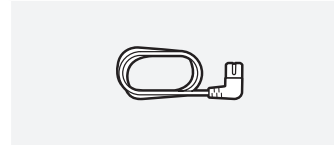

Power cable
(3903-001117)

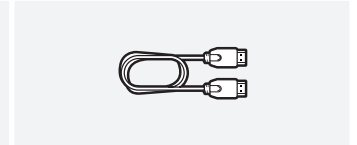

HDMI Cable
(May not be provided in some regions) / (BN39-02661A)

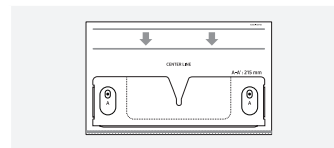

Wall-mounting Guide
(AH85-01091B)



Holder Screw
(AH61-03164A)



Screw (M4 x L10) x 2
(6001-001202)

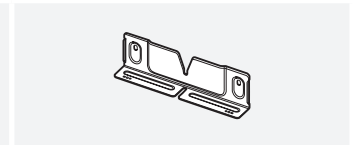

Wall-mounting Bracket
(AH61-04313A)



Holder Anchor x 2
(BN61-17904A)



Screw for mounting on wall
(M5 x L55) x 2
(6011-008215)



Rubber Foot x 4
(BN67-00398L)

- Some components may differ by model and region, and may not be provided. (e.g., HDMI cable, batteries, etc.)
- Refer to the information label located on the bottom or rear of the product for details about power consumption and supply specifications.
- To purchase additional components or optional cables, contact a Samsung Service Center or Samsung Customer Care.
- For more details about the wall mount and rubber foot, See the "[Installing the Soundbar on a Wall](#)" section.
- To enhance the product, product design, specifications, and app interface may change without prior notice.
- The color and shape of parts may vary from what is depicted.

03 Product Overview

Front side

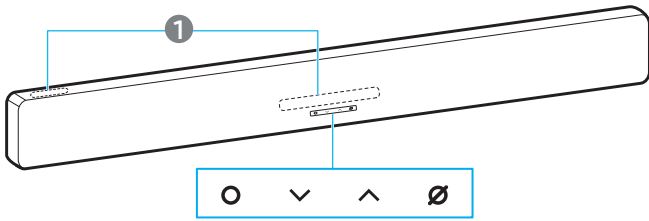

* The orientation of the product image is based on the standard for wall-mounted installation.

1	LED indicator <ul style="list-style-type: none"> The LED indicator may blink, turn on, or change color, depending on the current mode or state. The color and number of LED indicators represent the active modes as follows. Multi-color LED changes to white, turquoise, green, red, or blue, depending on the mode or status. <table border="1"> <tr> <td></td> <td></td> <td></td> <td></td> <td></td> </tr> <tr> <td>White LED</td> <td>White LED</td> <td>Multi-color LED</td> <td>White LED</td> <td>White LED</td> </tr> </table> <ul style="list-style-type: none"> The LED indicator may light up on only one side, depending on the installation direction. <p>[When wall-mounted]</p> <p>[When table-mounted]</p>						White LED	White LED	Multi-color LED	White LED	White LED
White LED	White LED	Multi-color LED	White LED	White LED							
∨ ∨ ∨	(Volume) Button Adjusts the volume.										
○	(Multi) Button <ul style="list-style-type: none"> In Standby mode, you can turn on the soundbar by pressing the (Multi) button. You can switch the input source by pressing the (Multi) button. <table border="1"> <tr> <td> LED indicator </td> <td></td> </tr> <tr> <td> White On → Off </td> <td>TV ARC or eARC</td> </tr> <tr> <td> White On → Off </td> <td>HDMI</td> </tr> <tr> <td> White On → Off </td> <td>Bluetooth</td> </tr> </table>	LED indicator		 White On → Off	TV ARC or eARC	 White On → Off	HDMI	 White On → Off	Bluetooth		
LED indicator											
 White On → Off	TV ARC or eARC										
 White On → Off	HDMI										
 White On → Off	Bluetooth										

∅	(Microphone) Button <ul style="list-style-type: none"> Press the (Microphone) button to turn the microphone on or off. When the microphone is off, the LED indicator will turn red. Press and hold the (Microphone) button on the top of the soundbar for 3 seconds or longer to switch to Bluetooth mode. 	
	LED indicator	
	 Red On	Microphone Off
	 Red Off	Microphone On

- When you turn on the soundbar, it may take 4 to 5 seconds for the sound to start.
- If audio plays from both the TV and soundbar, open the TV's **Audio Settings** menu, then select **External Speaker** instead of TV Speaker.

Rear side

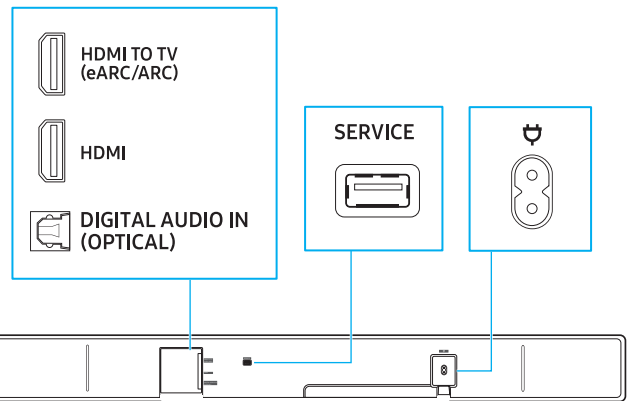

DIGITAL AUDIO IN (OPTICAL)	Connect to a digital (optical) output terminal of a TV or external device. (See the " Connecting using an Optical Cable " section.)
SERVICE	Use this port to update firmware through USB.
HDMI TO TV (eARC/ARC)	Use this HDMI port to connect to a TV. (See the " Connect to a TV that supports HDMI ARC (Audio Return Channel) " section.)
HDMI	This port is used for connecting an HDMI cable to transmit digital video and audio simultaneously. Connect to an HDMI output of external devices. (See the " Connecting by HDMI Cable " section.)
	Connect the power cable to this power port. (See the " Connecting the Power and Devices " section.)

04 Using the Remote Control

How to use the Remote Control

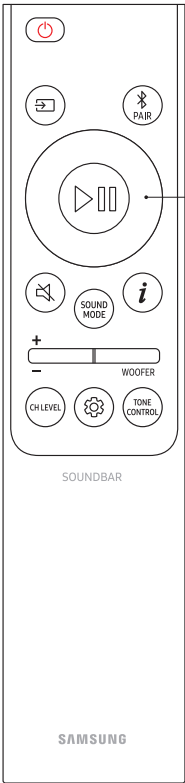

Install Batteries (AAA battery X 2)

Slide the battery cover in the direction of the arrow until it is fully removed. After inserting the batteries (1.5V, AAA) in the correct direction, slide the back cover onto the remote control in the direction of the arrow.

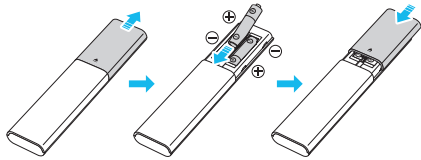



(Power)

Turns the soundbar on or off.
The soundbar will automatically turn off in the following situations. (Power saving mode)

- TV ARC, HDMI, Wi-Fi, Bluetooth, DIGITAL AUDIO IN Mode: No audio signal input for 18 minutes or longer
- In the case of Bluetooth, it won't work if it is connected to another device, even if there is no audio signal input.

LED indicator	Status
○ ○ ● ○ ○ Cyan blinking x1	On
○ ○ ● ○ ○ Red blinking x3	Off



(Source)

- You can choose the device connected to the soundbar.
- Turn voice feedback on or off
You can turn voice feedback on or off.
With the soundbar turned off (in Standby mode), press and hold the  (Source) button on the remote control for 5 seconds.
Whenever you change the voice feedback settings, the LED indicator will change.

LED indicator	Status
○ ○ ● ○ ○ Cyan blinking x1	On
○ ○ ● ○ ○ White blinking x1	Off





(Bluetooth connection)

Puts the soundbar into the Bluetooth pairing mode. Press this button to change the LED indicator as below:

- The multi-color LED will sequentially change from **Red** → **Green** → **Blue** until the pairing is complete.

LED indicator	Status
○ ○ ● ○ ○ Red → Green → Blue blinking	Pairing
○ ○ ● ○ ○ Cyan blinking x3	Connection successful

 **Ready to connect by Bluetooth.**



(Up/Down/Left/Right)

Use the **Up/Down/Left/Right** buttons to make fine adjustments.

- Skip a song**
Press the **Right** button to skip to the next song.
Press the **Left** button to go to the previous song.



(Play/Pause)



















Starts or pauses playback.

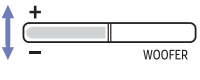
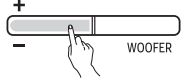















(Mute)

To mute the soundbar, press the  **Mute** button. Press it again to unmute.

LED indicator
○ ○ ○ ○ ● White blinking

 (Sound mode)	<p>Select the desired sound mode from among Surround, Game pro, Standard, and AI Adaptive Sound.</p> <ul style="list-style-type: none"> • Surround Surround sound will be activated. • Game pro This mode is optimized for gaming, providing a more immersive sound experience. • Standard The original sound will be played back. • AI Adaptive Sound In this mode, content is analyzed in real time and optimal sound is played based on the type of content. <table border="1" data-bbox="236 533 751 739"> <tr> <th>LED indicator</th> </tr> <tr> <td>  White blinking X1 </td> </tr> <tr> <td>  Surround → Game pro → Standard → AI Adaptive Sound </td> </tr> </table>	LED indicator	 White blinking X1	 Surround → Game pro → Standard → AI Adaptive Sound
LED indicator				
 White blinking X1				
 Surround → Game pro → Standard → AI Adaptive Sound				
 (Info)	<p>Press the button to display information about the current function. (See the "Front side" section.) When connected to Dolby Atmos®, the LED indicator blinks cyan 3 times.</p>			
 (Woofer (bass) Level)	 <p>You can adjust the Woofer (bass) Level by sliding the button up or down.</p>			
 (Volume)	 <p>Press the Up or Down button to adjust the volume.</p>  <ul style="list-style-type: none"> • Mute Press the Volume button. Press it again to unmute. 			
 (Channel level)	<p>You can adjust the volume of each speaker, including the Center, Side, Wide, Front top, Rear and Rear top speakers.</p> <ul style="list-style-type: none"> • To adjust the volume of each speaker, select the Center Level, Side Level, Wide Level, or Front Top Level in the sound settings, then use the Up/Down buttons to adjust the volume between -6 and +6. • The Rear Level or Rear Top Level can be selected when connected to the SWA-9500S (Surround speaker, sold separately). <table border="1" data-bbox="236 1697 751 1904"> <tr> <th>LED indicator</th> </tr> <tr> <td>  White blinking X1 </td> </tr> <tr> <td>  Center Level → Side Level → Wide Level → Front Top Level → Rear Level → Rear Top Level </td> </tr> </table>	LED indicator	 White blinking X1	 Center Level → Side Level → Wide Level → Front Top Level → Rear Level → Rear Top Level
LED indicator				
 White blinking X1				
 Center Level → Side Level → Wide Level → Front Top Level → Rear Level → Rear Top Level				

 (Sound Control)	<p>You can select audio features such as SpaceFit Sound Pro, AVA Pro, Sound Elevation, Auto Volume, Bass enhancement, Voice enhancement, Night mode, Sync, Sound Grouping, Private rear sound, and Virtual.</p> <p>To adjust a sound setting, press the Up or Down button to select your desired option.</p> <ul style="list-style-type: none"> • (See the "Setting the  (Sound Control)" section.) <table border="1" data-bbox="997 392 1516 660"> <tr> <th>LED indicator</th> </tr> <tr> <td>  White blinking X1 </td> </tr> <tr> <td>  SpaceFit Sound Pro → AVA Pro → Sound Elevation → Auto Volume → Bass enhancement → Voice enhancement → Night mode → Sync → Sound Grouping → Private rear sound → Virtual </td> </tr> </table>	LED indicator	 White blinking X1	 SpaceFit Sound Pro → AVA Pro → Sound Elevation → Auto Volume → Bass enhancement → Voice enhancement → Night mode → Sync → Sound Grouping → Private rear sound → Virtual
LED indicator				
 White blinking X1				
 SpaceFit Sound Pro → AVA Pro → Sound Elevation → Auto Volume → Bass enhancement → Voice enhancement → Night mode → Sync → Sound Grouping → Private rear sound → Virtual				
 (Tone control)	<p>Adjust the treble and bass levels by pressing the respective buttons. After selecting an option, use the Up/Down buttons to adjust the settings.</p> <ul style="list-style-type: none"> • This feature is available in all sound modes except Standard mode. • Adjust the treble or bass levels by selecting Treble or Bass in the Sound Control. Then, use the Up/Down buttons to adjust the volume level within the range of -6 to +6. • When adjusting the Bass levels, the woofer levels will also be affected. <table border="1" data-bbox="997 1030 1516 1209"> <tr> <th>LED indicator</th> </tr> <tr> <td>  White blinking X1 </td> </tr> <tr> <td>  Treble → Bass </td> </tr> </table>	LED indicator	 White blinking X1	 Treble → Bass
LED indicator				
 White blinking X1				
 Treble → Bass				

Setting the (Sound Control)

- **SpaceFit Sound Pro** : This feature analyzes your listening space using the soundbar's microphone to deliver optimal audio quality. Sound optimization runs automatically.
- **AVA Pro (Active Voice Amplifier Pro)** : This feature analyzes external noise to ensure clear voice quality. No data is collected or stored during analysis.
- **Sound Elevation**: When the soundbar is placed below the TV, this feature compensates for the mismatch between the sound output position and the visual position on the screen.
 - When this feature is set to **ON**, you can experience the effect of the sound coming directly from the TV screen.
 - This feature is available only when **Sound Grouping** or **Private Rear** is set to **OFF**.
 - When **Sound Grouping** or **Private Rear** is set to **ON**, this feature is not supported.
- **Auto Volume**: This feature automatically adjusts the volume to maintain a consistent level when changing content or switching to another external input.
 - This function is available only when **Q-Symphony** is set to **OFF**.
 - When **Q-Symphony** is set to **ON**, this feature is not supported.
- **Bass enhancement** : Emphasizes low-frequency signals.
- **Voice enhancement**: Improves the dialogue quality in videos and TV shows, making it easier to hear.
- **Night mode**: Optimizes the listening experience at night by lowering the volume while keeping spoken dialog clear.
- **Sound Grouping**: The full sound is played through both the soundbar and rear speakers, making it ideal for a group of people in a large space.
 - When the rear speakers are connected for the first time, the Sound Grouping menu will be available. After that, the menu will remain available, regardless of whether the rear speakers are connected.
 - In **Sound Grouping** mode, sound modes won't affect the audio.
 - Sound will only come from specific speakers, not from the soundbar and all rear speakers. This may vary by model.
- **Private Rear**: This feature allows you to send audio to only the rear speakers, so you can listen without being disturbed.
 - In this mode, no sound will come from the soundbar or subwoofer. Only the front channels of the rear speakers will produce sound.
 - In **Private Rear** mode, sound modes won't affect the audio.
 - When the soundbar is turned off or the connection to the rear speakers is lost, the mode will turn off.
 - The **Private Rear** will only be available when a rear speaker is connected.
 - When connecting **Q-Symphony**, the **Private Rear** mode will automatically turn off and can't be turned back on.
- **Sync**: If the video and audio are out of sync when played through the TV and soundbar, go to the **Sound Control** and select **Sync**. Then, use the **Up/Down** buttons to adjust the audio delay between 0 and 300 milliseconds.
 - **Sync** is supported only in certain functions.
- **Virtual** : While **Surround** mode is on, it provides extended sound effects when playing Dolby/DTS content. This feature can be turned On/Off by using the **Up/Down** buttons.
- To adjust the sound of each frequency, press and hold the  (**Sound Control**) button for about 5 seconds. You can select 150Hz, 300Hz, 600Hz, 1.2kHz, 2.5kHz, 5kHz, or 10kHz with the **Left/Right** buttons, and make adjustments within the range of -6 to +6 using the **Up/Down** buttons. (This feature only works when the sound mode is set to **Standard**.)

Output specifications for each sound mode

For using the soundbar

Effect	Input	Output
Standard	2.0 Channel	2.1 Channel
	5.1 Channel	5.1 Channel
	7.1 Channel	7.1 Channel
	Dolby Atmos®, DTS:X	7.1.2 Channel
Surround Game pro AI Adaptive Sound	2.0 Channel	7.1.2 Channel
	5.1 Channel	7.1.2 Channel
	7.1 Channel	7.1.2 Channel
	Dolby Atmos®, DTS:X	7.1.2 Channel

For using the surround speaker (SWA-9500S, optional) together

Effect	Input	Output
Standard	2.0 Channel	2.1 Channel
	5.1 Channel	5.1 Channel
	7.1 Channel	7.1 Channel
	Dolby Atmos®, DTS:X	9.1.4 Channel
Surround Game pro AI Adaptive Sound	2.0 Channel	9.1.4 Channel
	5.1 Channel	9.1.4 Channel
	7.1 Channel	9.1.4 Channel
	Dolby Atmos®, DTS:X	9.1.4 Channel









The surround speakers won't produce sound for 2-channel output while **Standard** effect mode is active. To turn on sound for the surround speakers, change the effect mode to **Surround**.

Adjusting the Soundbar Volume with the TV Remote Control

This feature allows you to adjust the soundbar volume using the TV's remote control.

- This function can only be used with an IR remote control. Bluetooth remote controls (those that need pairing) aren't supported.
- The above item only operates in certain input modes of the soundbar.
- Manufacturers that support this feature
Samsung, VIZIO, LG, Sony, Sharp, PHILIPS, PANASONIC, TOSHIBA, Hisense, RCA

1. Turn off the soundbar.
2. Push the **Woofers (bass) Level** button up and hold for 5 seconds. When you press and hold the **Woofers (bass) Level** button for up to 5 seconds, the mode will change in the following sequence: **OFF-TV REMOTE**, (default) **SAMSUNG-TV REMOTE**, and then **ALL-TV REMOTE**.

Remote control button	Display	Status
 5 seconds 	Red blinking X1  OFF-TV REMOTE (Default)	Disables the TV remote control.
 5 seconds 	Cyan blinking X1  SAMSUNG-TV REMOTE	Controls the soundbar with a Samsung TV IR remote control.
 5 seconds 	Blue blinking X1  ALL-TV REMOTE	Controls the soundbar with a different TV manufacturer's and Samsung TV IR remote control.

05 Connecting the Soundbar to Other Units

Connecting the Power and Devices

Using the power cords, connect the soundbar to an electrical outlet in the following order:

- Refer to the information label located on the bottom or rear of the product for details about power consumption and supply specifications.
- Always grip the plug firmly and pull it directly when disconnecting the power cord from the wall outlet. Do not pull on the power cord itself.
- Once all devices are connected, connect the soundbar and other devices to an electrical power outlet.

Connect the power cord to the soundbar.

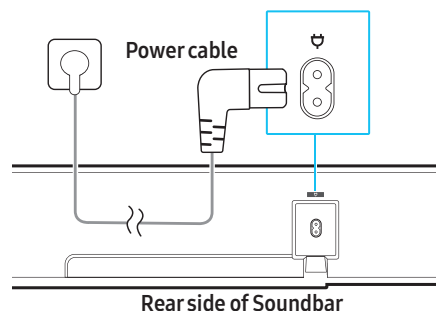

NOTE

- If you disconnect the power cord while the soundbar is on, and reconnect it to a power outlet, the soundbar will automatically turn on.

Connecting an Samsung Wireless Rear Speaker Kit (Sold Separately) to your Soundbar

Expand to true wireless surround sound by connecting the Samsung Wireless Rear Speaker Kit(sold separately) to your Soundbar.

For detailed information on connections, see the Samsung Wireless Rear Speaker Kit manual.

06 Connecting to a TV

Connect to a TV that supports HDMI ARC (Audio Return Channel)

⚠ CAUTION

- If both an HDMI cable and an optical cable are connected, the HDMI cable signal will take priority.
- When connecting the TV and soundbar with an HDMI cable, make sure to connect the ports labeled eARC or ARC. If the correct port isn't used, the TV won't make any sound.
- Using HDMI cables certified by HDMI.org is recommended.

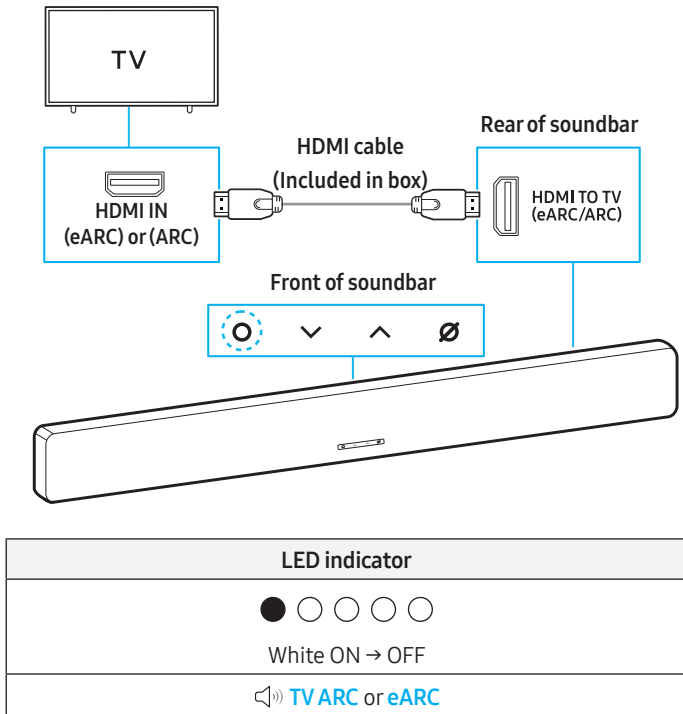

1. While the soundbar and TV are turned off, connect the HDMI cable as shown in the diagram above.
2. Turn on the soundbar and TV.
3. TV sound will play through the soundbar.
 - If there is no sound from the TV, press the **○ (Multi)** button on the soundbar or press the **➡ (Source)** button on the remote control to switch to the appropriate connected mode.
 - To connect with eARC, the eARC function in the TV menu should be turned on. Refer to the TV user manual for details about how to configure the settings. (e.g.) Samsung TV : Home (🏠) → Settings (⚙) → All Settings (⚙) → Sound → Expert Settings → HDMI-eARC Mode (Auto)
 - You can use the volume buttons on your TV remote control to adjust the soundbar volume.

NOTE

- When connecting a TV and soundbar that support HDMI ARC (Audio Return Channel) using an HDMI cable, digital video and audio data can be transmitted without a separate optical cable.
- Using a coreless HDMI cable is recommended whenever possible. If using a cored HDMI cable, ensure its diameter is less than 14 mm.
- This function won't work if the HDMI cable doesn't support ARC.
- If the broadcast audio is encoded in Dolby and the "Digital Output Audio Format" in your TV is set to PCM, changing the settings to Dolby Digital, Dolby Digital+, or Auto is recommended for optimal sound. Changing the setting will provide better sound quality. (The TV menu may use different terms for Dolby Digital and PCM, depending on the manufacturer.)
- ARC/eARC protocol supports Dolby Atmos®.
- Check if the content you want to use support Dolby Atmos®.

Connecting Using an Optical Cable

Pre-connection Checklist

- If both an HDMI cable and an optical cable are connected, the HDMI cable signal will take priority.
- When using an optical cable, make sure to remove the cap from the optical cable before use.

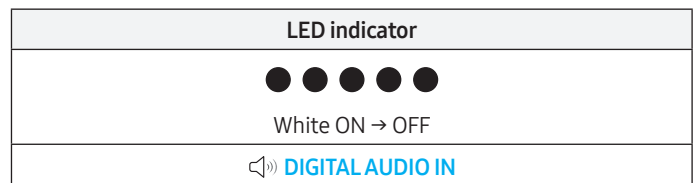
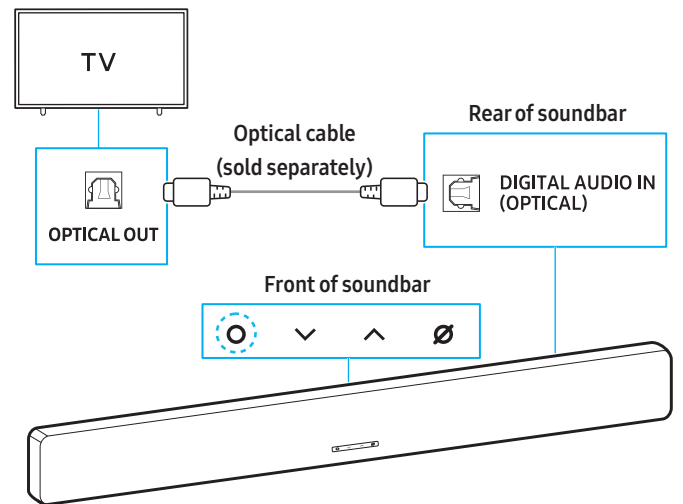

1. While the TV and soundbar are turned off, connect the **DIGITAL AUDIO IN (OPTICAL)** on the soundbar to the **OPTICAL OUT** port on the external device using an optical cable (sold separately), as shown in the above diagram.
2. Turn on the soundbar and TV.
3. Press the **○ (Multi)** button on the soundbar or press the **➡ (Source)** button on the remote control to switch to **DIGITAL AUDIO IN** mode. TV sound will play through the soundbar.

Connecting by Bluetooth

Connecting your Samsung TV to the soundbar by Bluetooth allows you to enjoy stereo sound without the need for cables.

- Only one Samsung TV can be connected by Bluetooth at a time.
- You can connect to a Samsung TV with Bluetooth support. Make sure to check your TV's specifications.

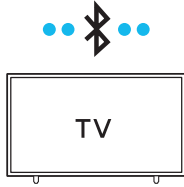

Connecting to Bluetooth for the first time

Bluetooth pairing button	LED indicator
<p>(Or)</p>	<p>[Pairing]</p> <p>○ ○ ● ○ ○</p> <p>Red → Green → Blue blinking</p> <p>↓</p> <p>[Connection successful]</p> <p>○ ○ ● ○ ○</p> <p>Cyan blinking x3</p>
	<p>🔊 Ready to connect by Bluetooth.</p>

1. Open the Bluetooth menu on the Samsung TV you want to connect. (Examples: Home (🏠) → Settings (⚙️) → All Settings (⚙️) → Sound → Sound Output → Bluetooth Speaker List → Soundbar Q-series (Bluetooth))
2. Select “**Q-series Soundbar**” from the list on the TV screen. On the Samsung TV Bluetooth device list, “**Need Pairing**” or “**Paired**” will appear for a device. To connect Samsung TV to the soundbar, select the corresponding message to establish the connection.
3. You can now enjoy Samsung TV audio through the soundbar.
 - If there is a connection log between the Soundbar and Samsung TV, the Soundbar is automatically connected by changing its mode to “**Bluetooth**”.

If the Device Fails to Connect

- When a previously connected soundbar (e.g., If **Q-series Soundbar**) appears in the Samsung TV speaker list, delete it.
- Repeat steps 1 through 3.

Disconnecting the Soundbar from the Samsung TV

Press the **○ (Multi)** button on the soundbar or press the **➡ (Source)** button on the remote control and switch to any other mode besides **Bluetooth**.

- Ending the connection may take a few seconds as the TV waits for a response from the soundbar. (The disconnection time may vary, depending on the Samsung TV model.)

Precautions when connecting to Bluetooth

- Position the device you are connecting to the soundbar by Bluetooth within 1 meter.
- If prompted for a PIN code when connecting to a Bluetooth device, enter <0000>.
- The soundbar will automatically turn off after 18 minutes of inactivity in Standby mode.
- The soundbar may have difficulty scanning for available Bluetooth devices or connecting properly under the following conditions:
 - If there are nearby electronic devices or equipment causing radio interference.
 - If multiple Bluetooth devices are simultaneously paired with the soundbar.
 - If the Bluetooth device is turned off, out of range, or experiencing a malfunction.
- Electronic devices may cause radio interference. Keep any device that generates electromagnetic waves away from the soundbar. (e.g., microwave oven, wireless LAN, etc.)
- Press and hold the **TONE CONTROL** button on the remote control for 30 seconds or longer to turn Bluetooth on or off. **When you turn Bluetooth on or off, the soundbar will automatically restart.**

Connecting by Wi-Fi (Wireless Network)

Pre-connection Checklist

- Wi-Fi connection is only available on a Samsung TV.
- Check if the **wireless router (Wi-Fi)** is turned on and the **TV is connected to the wireless router**.
- Connect the soundbar and TV to the same Wi-Fi network.
- If your wireless router (Wi-Fi) uses a DFS channel, you won't be able to connect the TV and soundbar by Wi-Fi. Contact your Internet Service Provider for more details.
- Check your TV's manual since the menu may vary, depending on the year of manufacture.
- Connect the soundbar to the wireless router first so that you can connect the soundbar and TV by Wi-Fi. (See the "[Connecting by Wi-Fi \(Wireless Network\)](#)" section.)

1. For more information on how to connect your soundbar to a Wi-Fi network, see the "[Connecting by Wi-Fi \(Wireless Network\)](#)" section.
2. On the TV Sound menu, change the input source to soundbar.
 - **For Samsung TVs released in 2017 or later**
Home (🏠) → Settings (⚙️) → All Settings (⚙️) → Sound → Sound Output → Q-series Soundbar (Wi-Fi)

NOTE

- Wi-Fi Dolby Atmos connectivity is only available on some Samsung TVs and soundbar.
- To ensure safe and secure use of the product, connect to the network using a securely managed router.
- When the network is connected, it enables casting YouTube content, Connecting by Wi-Fi, Apple Airplay, Spotify, Alexa, SmartThings, Tidal, ChromeCast and Roon Ready. Services supported by software updates are subject to change.
- To use Wi-Fi Direct, the Soundbar and your Smart TV must be connected to each other on the same network.
- Press and hold the **CH LEVEL** button on the Remote Control for 30 seconds or longer to turn Wi-Fi on or off.
When you turn Wi-Fi on or off, the soundbar will automatically restart.

Using the Q-Symphony Feature

- If you connect the soundbar to a Samsung TV that supports Q-Symphony, sound will play from both the soundbar and TV at the same time. You can enjoy a richer, more immersive sound with the TV's surround sound.
- When the soundbar is connected to your TV, "**Q-Symphony**" will appear on your TV.
Settings (⚙️) → All Settings (⚙️) → Sound → Sound Output

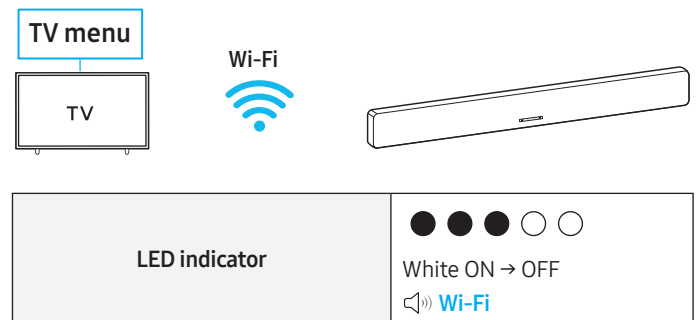
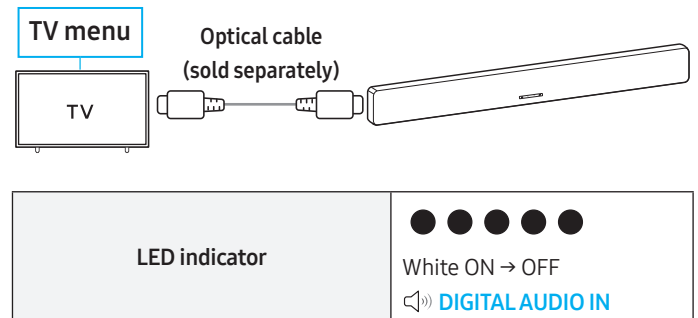
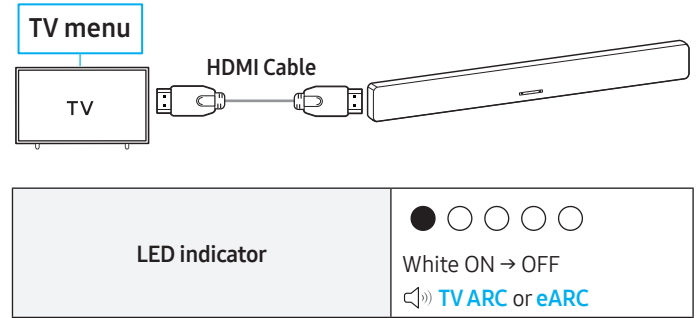

NOTE

- It will work with the codec supported by the TV.
- This feature is only supported when connected by HDMI cable, optical cable (sold separately), or Wi-Fi.
- The messages displayed on the TV may vary, depending on the model.
- Check and see if your soundbar and TV are connected to the same Wi-Fi network/frequency.
- This function is only available on some Samsung TVs and soundbar.

Using SpaceFit Sound Pro

SpaceFit Sound Pro analyzes the listening environment through the soundbar's microphone and provides optimized sound quality tailored to the space. Sound optimization is performed automatically.

1. Soundbar Connection

To use this feature, enable the SpaceFit Sound Pro mode using the soundbar's remote control.

((Sound Control) → SpaceFit Sound Off → ▲ (Up) → SpaceFit Sound On)

This feature can be used in all sound modes.

2. TV Connection

To use this feature, enable the AI Adaptive Sound+ mode from the Samsung TV menu.

(Home (🏠) → Settings (⚙️) → All Settings (⚙️) → General → Intelligent Mode Settings → AI Adaptive Sound+)

- When AI Adaptive Sound+ mode is enabled in the TV menu, the soundbar's sound mode will automatically switch to AI Adaptive Sound+.

NOTE

This feature operates only when certain Samsung TVs are connected with the soundbar.

07 Connecting an External Device

Connecting by HDMI Cable

Pre-connection Checklist

- If any secondary audio settings are on, turn them off in your audio output options.
- Check if the content you want to use support Dolby Atmos®.
- Choose an HDMI cable that meets the required HDMI input/output specifications.
- To receive UHD signals, you must use an HDMI cable certified by HDMI.org.
- To receive UHD signals, check the video playback specifications of your TV and external device and also the settings of the device in use.
- Refer to your TV or external device manual for more details.

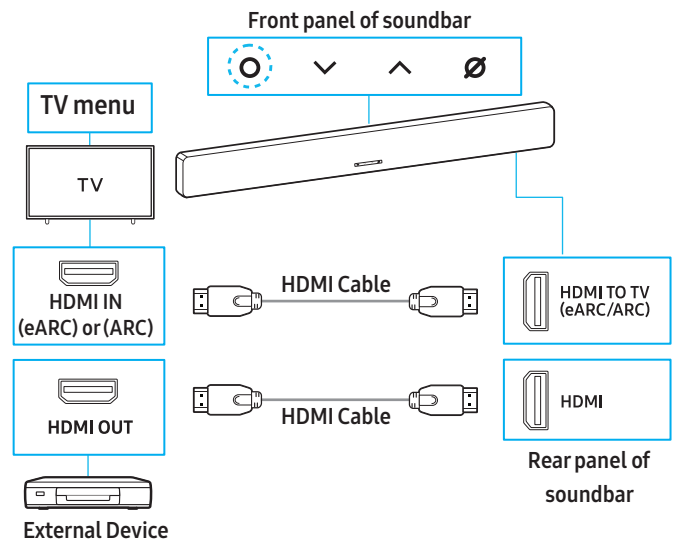

- Use an HDMI cable to connect the **HDMI OUT** port on the external device to the HDMI port at the rear of the soundbar.
- Use an HDMI cable (included) to connect the **HDMI IN** port of the TV to the **HDMI TO TV (eARC/ARC)** port at the rear of the soundbar.
- Turn on the soundbar, TV, and external device.
- Press the **○ (Multi)** button on the soundbar or press the (**Source**) button on the remote control to switch to **HDMI** mode.

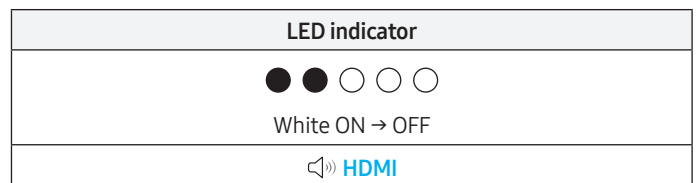

NOTE

- When using **Dolby Atmos®/DTS:X**: If the inputted source is Dolby Atmos®/DTS:X, see the "[Output specifications for each sound mode](#)" section.
- Configuring Dolby Atmos® in BD Player or Other Devices**
Check the audio output options in the settings menu on the BD player or other device. "No Encoding" should be selected for bitstream in the audio output options.
Example) When using a Samsung BD Player: go to Home → Menu → Sound → Digital Output and then select Bitstream (Unprocessed)

UHD signal support specifications (3840 x 2160p)

Frame rate (fps)	Color depth	RGB 4:4:4	YCbCr 4:4:4	YCbCr 4:2:2	YCbCr 4:2:0
< 60	8 bit	0	0	0	0
	10 bit	-	-	0	0
	12 bit	-	-	-	-
120	8 bit	-	-	-	-
	10 bit	-	-	-	-

- Supported specifications may vary based on the external device connected to the soundbar or the usage conditions.

Connecting using an Optical Cable

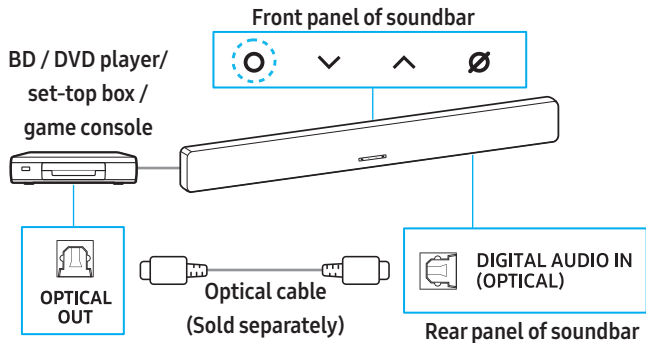

- Use an optical cable (sold separately) to connect the **DIGITAL AUDIO IN (OPTICAL)** port on the soundbar to the **OPTICAL OUT** port on the external device.
- Turn on the soundbar and external device.
- Select **DIGITAL AUDIO IN** mode by pressing the **⊙ (Multi)** button on the soundbar or pressing the **☐ (Source)** button on the remote control.
- Your soundbar will play audio from the external device.

LED indicator
● ● ● ● ●
White ON → OFF
🔊 DIGITAL AUDIO IN

08 Connecting a Mobile Device

Connecting by Bluetooth

Connecting your mobile device to the soundbar by Bluetooth allows you to enjoy stereo sound without the need for cables.

- The soundbar will turn on if you try to connect a previously paired Bluetooth device while the soundbar is turned off.

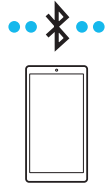

Connecting to Bluetooth for the first time

- Position the device you are connecting to the soundbar by Bluetooth within 1 meter (3.28 feet).

Bluetooth pairing button	LED indicator
<p>(Or)</p>	<p>[Pairing]</p> <p>○ ○ ● ○ ○</p> <p>Red → Green → Blue blinking</p> <p>↓</p> <p>[Connection successful]</p> <p>○ ○ ● ○ ○</p> <p>Cyan blinking x3</p>
	<p>🔊 Ready to connect by Bluetooth.</p>

- Select "**Q-series Soundbar**" when it appears on the list in the device.
- Enjoy music from your mobile device connected by Bluetooth through the soundbar.

If the Device Fails to Connect

- When a previously connected soundbar (e.g., "**Q-series Soundbar**") appears in the speaker list of your mobile device, delete it.
- Repeat steps 1 through 2.

Precautions when connecting to Bluetooth

- Position the device you are connecting to the soundbar by Bluetooth within 1 meter.
- If prompted for a PIN code when connecting to a Bluetooth device, enter <0000>.
- The soundbar will automatically turn off after 18 minutes of inactivity in Standby mode.
- The soundbar may have difficulty scanning for available Bluetooth devices or connecting properly under the following conditions:
 - In case there are nearby electronic devices or equipment causing radio interference.
 - If multiple Bluetooth devices are simultaneously paired with the soundbar.
 - If the Bluetooth device is turned off, out of range, or experiencing a malfunction.
- Electronic devices may cause radio interference. Keep any device that generates electromagnetic waves away from the soundbar. (e.g., microwave oven, wireless LAN, etc.)
- The soundbar supports SBC data (44.1kHz, 48kHz).
- Only connect to Bluetooth devices that support A2DP (AV).
- When connecting the soundbar to a Bluetooth device, keep them as close to each other as possible.
- The greater the distance between the soundbar and Bluetooth device, the lower the audio quality will be. The Bluetooth connection may be lost if the devices are out of range.
- The Bluetooth connection may not work properly in areas with weak signal reception.
- A Bluetooth device may experience noise or malfunction under the following conditions:
 - If a part of your body comes in contact with the signal transceiver of the Bluetooth device or soundbar
 - In corners or when there is an obstacle in proximity, such as a wall or partition, where electrical changes may occur.
 - When exposed to radio interferences by other products operating on the same frequency ranges, such as medical equipment, microwave ovens, and wireless LAN devices.
 - Obstacles such as doors and walls may degrade audio quality even if the devices are within operational range.
- Note that your soundbar can't be paired with other Bluetooth devices while Bluetooth audio is being played.
- This wireless device may cause electrical interference during operation.

Disconnecting a connected Bluetooth device

Refer to the Bluetooth device's user manual for more details.

- The connection with the soundbar is disconnected.
- If the soundbar is disconnected from the Bluetooth device, the multi-color LED indicator on the soundbar blinks red three times.

Disconnecting the soundbar from the Bluetooth device

Press the **○ (Multi)** button on the soundbar or press the **↔ (Source)** button on the remote control and switch to any other mode besides **Bluetooth**.

- Ending the connection may take a few seconds as the Bluetooth device waits for a response from the soundbar. (The disconnection time may vary, depending on the Bluetooth device.)

Connecting by Wi-Fi (Wireless Network)

For **Samsung Sound** to work properly, a specific or higher version of the OS is required.

For more information on OS versions, please see the **Samsung Sound** App description in the app marketplace for your OS.

1 - Installing app



You can control the soundbar and adjust settings using the **Samsung Sound** app.

Download the **Samsung Sound** app from your mobile device's app store (App Store, Play Store) or scan the provided QR code.

2 - Registering a device

1. On your mobile device, run the **Samsung Sound** app.
2. Follow the instructions displayed to register the product to your mobile device.
 - If a pop-up window doesn't appear, go to the app's home screen, then tap the **(+)** button to register the product.

NOTE

You can also register your soundbar to the **Samsung Sound** app by scanning the QR code on the soundbar.

If the device isn't found

1. Connect the mobile device to the soundbar by Bluetooth.
2. Tap Connected Devices in the **Samsung Sound** App.
3. Slide left on the screen to select the soundbar card on your mobile device. Then, tap Register device to Samsung account to register the device.

3 - Controlling the Soundbar with Samsung Sound

1. Open the **Samsung Sound** app on your mobile device and then select the soundbar you registered.
2. The settings menu will appear for the soundbar. You can adjust the settings such as **Volume**, **Sound Mode**, and **Equalizer**.
 - If another user wants to control the soundbar,
 - Make sure the mobile device is connected to the same Wi-Fi network as the soundbar.
 - Open the **Samsung Sound** app and follow the on-screen instructions to complete the setup. Once the setup is finished, the soundbar can be controlled through the app.

To change your Wi-Fi (wireless network)

1. On your mobile device (smartphone or tablet), run the **Samsung Sound** app.
2. After tapping the soundbar card, tap the **(⋮)** icon.
3. Tap **Device settings** > **Network status** > **Change Wi-Fi network**, then follow the on-screen instructions.

Using Group Play

- To use this feature, register your soundbar to the [Samsung Sound](#) app.
- This feature is only available on soundbar models released in 2024 or later.
- To turn on this feature, connect two or more devices to the same 5GHz Wi-Fi network.
- Menu names and settings may differ depending on the version of the Samsung Sound app.

Configuring Group Play

1. On your mobile device, run the [Samsung Sound](#) app.
2. To register your soundbar to the [Samsung Sound](#) app, refer to the "[Connecting by Wi-Fi \(Wireless Network\)](#)" section.
3. Tap on the soundbar card.
4. Set the soundbar source to Wi-Fi or Bluetooth.
5. On your mobile device, tap [Group Play Settings](#) under the audio device icon.
6. Turn on [Group Play](#).
7. Select a device from the list and tap [Apply](#).
 - We recommend connecting no more than 4 devices.
 - In [Group Play](#), audio from mobile devices connected to the host device will be output through the speakers connected in the group.
 - When the soundbar is connected to the TV by Wi-Fi, TV audio will be switched to the TV speakers.
 - If a device connected to the host device switches to another source, then that device is removed from the group.
 - When you connect a host device to the TV, the group that was created is deleted.

Disabling Group Play

1. Tap on the soundbar card.
2. On your mobile device, tap [Group Play Settings](#) under the audio device icon.
3. Turn off [Group Play](#).
 - To remove several devices, deselect (unmark) them in the list and tap [Apply](#).

Connecting to Apple AirPlay®

- This feature may not be available in some countries.
- The latest version of iOS, iPadOS, or macOS is recommended.
- To enable [AirPlay®](#) in your Soundbar, you must first register the device with the [Samsung Sound](#) app by agreeing with the app's terms and conditions.
- Make sure the Soundbar is powered on and connected to the same Wi-Fi network as your Apple® device.
- Apple®, AirPlay®, iPad®, iPhone®, and Mac® are trademarks of Apple Inc., registered in the U.S. and other countries and regions.

With [AirPlay®](#), you can enjoy music, podcasts, and other audio on the Samsung Soundbar right from your Apple® devices.

- Select  from an AirPlay-supported app or Control Center on your iPhone®, iPad®, or Mac®.
- Select the Soundbar from the list of available devices to play the current audio to.

09 Installing the Soundbar on a Wall

Precautions when installing

- Mount the soundbar only on a vertical wall.
- Avoid installing the soundbar system in areas with high temperatures or humidity.
- Install the system on a sturdy wall capable of supporting the soundbar's weight. If the wall can't support the soundbar's weight, reinforce it before installation. If reinforcement isn't possible, choose a different wall that can support the soundbar.
- Use screws or anchors suitable for the wall where the soundbar is being installed. (Gypsum board/steel/wood, etc.)
If possible, install the screws directly into the wall.
- Turn off the power and disconnect the soundbar before mounting it on the wall.
Failure to do so may result in electric shock.
- Connect all cables from external devices before mounting the soundbar on the wall.

Wall Mount Components

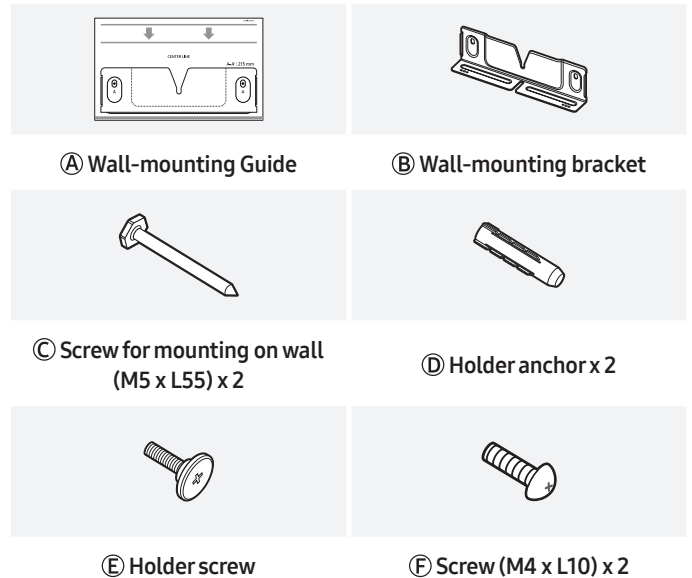

1. Attach the **Wall-mounting Guide** to the wall.
 - Attach the **Wall-mounting Guide** parallel to the wall.
 - If your TV is mounted on a wall, install it at least 1.5 cm (0.59 inches) or longer from the bottom of the TV.

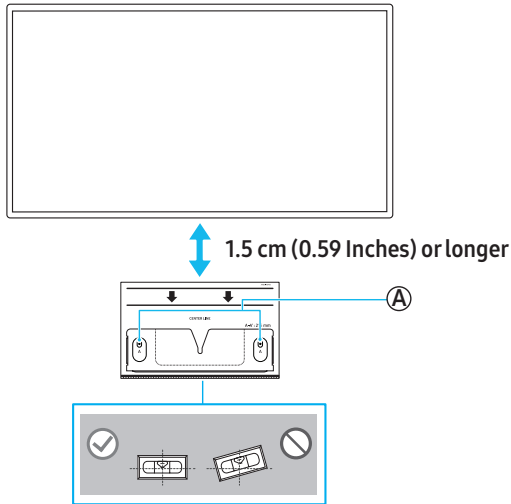

2. Align the **Wall-mounting Guide's center line** with the center of the TV on the wall (If you are mounting the soundbar below the TV), and then use tape to secure the **Wall-mounting Guide**.
 - If you aren't mounting below a TV, place the **Center line** in the center of the installation area.

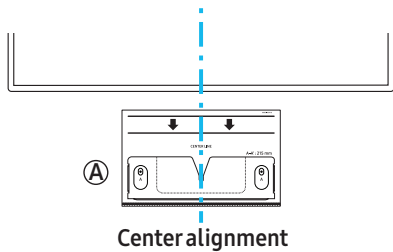

3. Use a pen or pencil to mark the center of the **A-TYPE** hole, and then remove the **Wall-mounting Guide**.

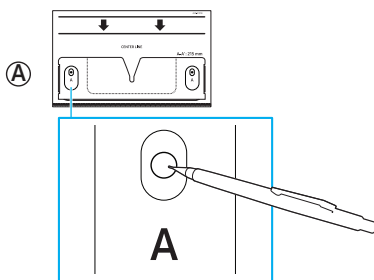

4. Using an appropriately sized drill bit, drill a hole where you marked on the wall.
5. Fasten the Screw for mounting on the wall into the marked spot.

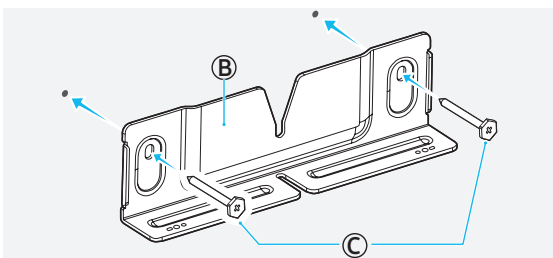

6. Fasten the **holder screw** to the rear of the soundbar.

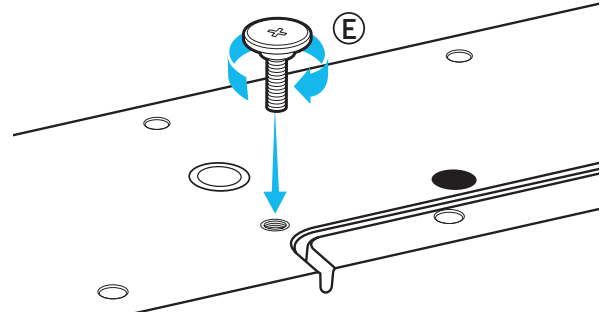

- When assembling, make sure the hanger part of the **Wall-mounting brackets** are located behind the rear of the soundbar.

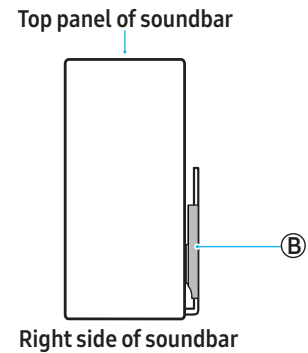

7. Mount the soundbar onto the **Wall-mounting Bracket**.
 - To ensure the soundbar is securely attached to the **Wall-mounting Bracket**, insert the **Holder screw** into the center of the **Wall-mounting Bracket** and push the soundbar downward.

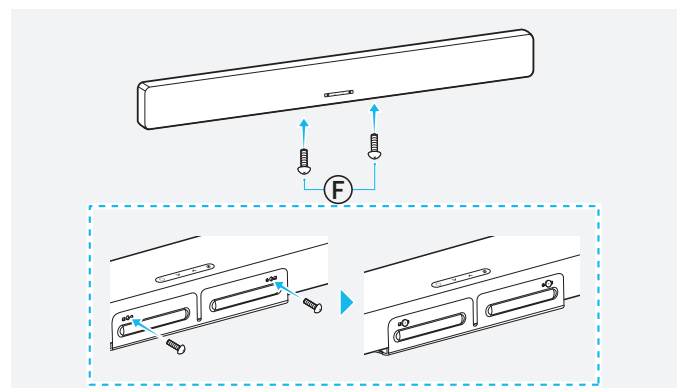
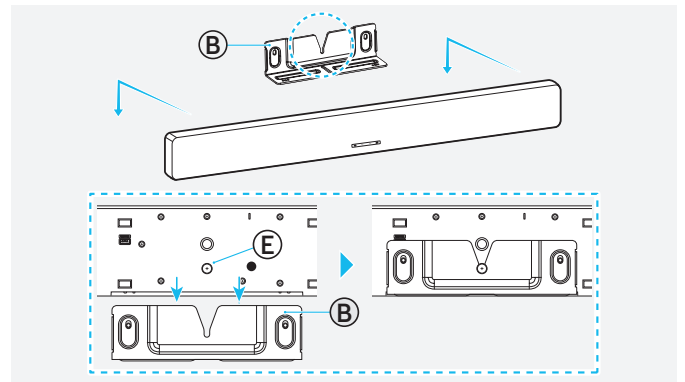

10 Installing the Soundbar on top of the TV Stand

Components

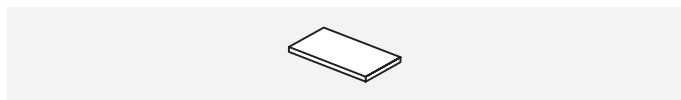

Rubber Foot x 4

1. Attach the **rubber foot** to the rear of the soundbar before placing it on top of the TV stand. The **rubber foot** should not be placed in a way that it extends beyond the TV stand's width. Please see the diagram below.

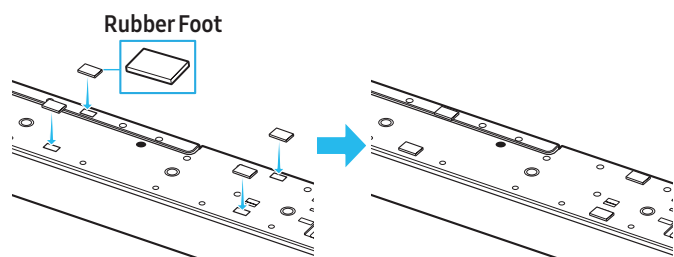

2. Install the soundbar on your TV. As shown in the image, align the center of the TV with the center of the soundbar, then carefully place the soundbar into the TV stand.

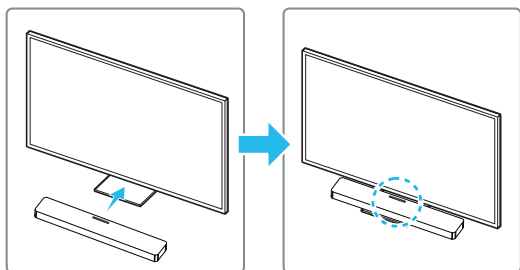

NOTE

- Make sure the soundbar is placed on a flat and solid surface.
- The actual product may vary in appearance from the image above, depending on the model.

11 Software Update

Automatic update

If your soundbar is connected to the internet, the software will automatically update even, while the soundbar is turned off.

- To use the automatic update feature, the soundbar must be connected to the internet.
If power to the soundbar is cut off or disconnected, the Wi-Fi connection will be lost. If power is cut off, turn the soundbar back on, or disconnect the power cord and then connect it again. Then, turn on the soundbar, and reconnect it to the internet.

USB update

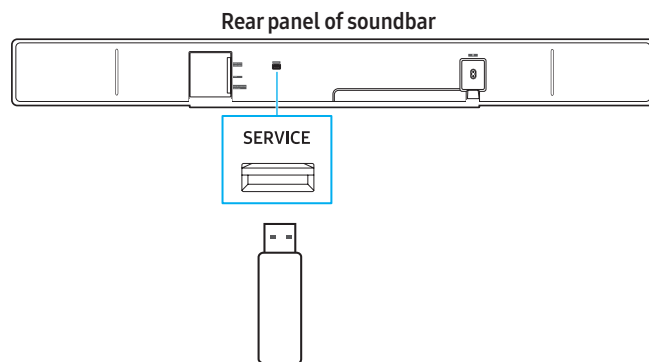

Samsung may provide firmware updates in the future for performance enhancements to the soundbar system.

If a new update is available, you can update the soundbar by connecting a USB storage device containing the firmware update to the **SERVICE** port on the soundbar.

1. Go to the Samsung website (www.samsung.com) → Go to Customer Support and search for your soundbar model name.
 - For more information on firmware updates, see the upgrade guide.
2. Download the Upgrade File (USB Type).
3. Unzip the downloaded compressed file into a folder created with an identical name to the compressed file.
4. Save the created folder to a USB thumb drive and connect it to the soundbar.
5. Turn on the soundbar. The product will be updated within 3 minutes.

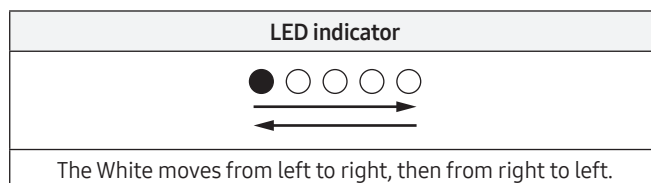

- Do not turn off the power or disconnect the USB thumb drive while the update is in progress.
- If your soundbar has the latest firmware installed, the update won't run.
- The update may not run, depending on the type of USB thumb drive.
- If there are no available update files, the indicator will blink red three times.

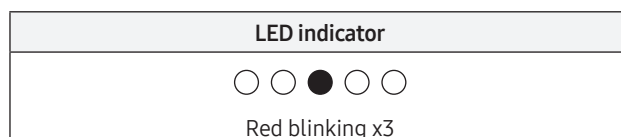





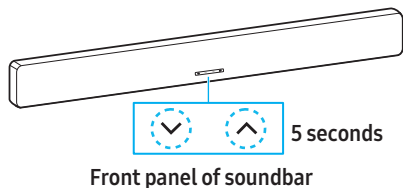

- If the version of the update file is the same as or lower than the current version, the indicator will blink cyan three times.

LED indicator
 Cyan blinking x3

Reset

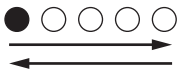

While the soundbar is turned on, press both   (Volume) buttons on the soundbar for 5 seconds or longer.

LED indicator	
	The white moves from left to right, then from right to left.
	
	Cyan blinking x3
	
	Red blinking x3 → OFF

CAUTION

This will reset all settings of the soundbar. Reset the soundbar only when needed.

Security updates information

Security updates are provided to strengthen the security of your device and protect your personal information. For more information on security updates, visit <https://security.samsungtv.com>.

- The website supports only some languages.

12 Troubleshooting

Refer to the instructions below if this product does not function properly. If the problem you are experiencing is not listed below or if the instructions below do not help, turn off the product, disconnect the power cord, and contact Samsung Electronics at 1-800-SAMSUNG (1-800-726-7864).

When the power doesn't turn on

- Check if the power cord is securely connected to the soundbar.

When some functions aren't working properly

- Disconnect the power cord, then connect it again.
- Turn off the connected external device, and then turn it back on.
- If there is no signal input, the soundbar will automatically turn off after a certain period.
Turn on the power.

If the remote control isn't working properly

- Bring the remote control closer to the soundbar and point it directly at the soundbar to select inputs.
- Replace the batteries with new ones.

If there is no sound coming from the soundbar

- The soundbar volume may be low, or the soundbar may be set to mute. Adjust the volume levels.
- When using external devices (STB, Bluetooth device, mobile device, etc.) connected to the soundbar, adjust the volume on each device.
- The sound output may be set to the TV. Select the soundbar as the sound output for the TV. (Samsung TV : Home (🏠) → Settings (⚙️) → All Settings (⚙️) → Sound → Sound Output → Select Soundbar)
- The cable connected to the soundbar may be loose. Disconnect the cable from the soundbar and then connect it again.
- Disconnect the power cord, connect it again, and then turn the soundbar on.
- Reset the soundbar and try again. (See the "[Reset](#)" section.)

When the TV can't connect to the HDMI TO TV (eARC/ARC)



- Make sure the HDMI cable is securely connected to the **ARC** or **eARC** port.
(See the "[Connect to a TV that supports HDMI ARC \(Audio Return Channel\)](#)" section.)
- The soundbar connection may not work due to other devices (such as set-top boxes, game consoles, etc.) connected to the TV. Connect only the soundbar to the TV, without any other devices.
- HDMI-CEC may not be turned on for the TV. Enable CEC in the TV menu. (Samsung TV: Home (🏠) → Settings (⚙️) → All Settings (⚙️) → Connection → External Device Manager → Anynet+ (HDMI-CEC) ON)
- To connect with eARC, the eARC function in the TV menu should be turned on.
(Samsung TV: Home (🏠) → Settings (⚙️) → All Settings (⚙️) → Sound → Expert Settings → HDMI-eARC Mode (Auto))

There is no audio when the TV is connected in HDMI TO TV (eARC/ARC) mode

- The soundbar can't reproduce the inputted signal. Change the TV's audio output to PCM or Dolby Digital. (Samsung TV: Home (🏠) → Settings (⚙️) → All Settings (⚙️) → Sound → Expert Settings → Digital Output Audio Format)

When a Bluetooth connection can't be established

- When connecting a new device to the soundbar, switch to Bluetooth mode to connect. (Press the **PAIR** button on the remote control, or press and hold the **(Microphone)** button on the soundbar for 3 seconds or longer.)
- If the soundbar is connected to another device, disconnect that device first to switch to another device.
- Remove the speaker from the Bluetooth speaker list in the device, then reconnect.
(Samsung TV : Home (🏠) → Settings (⚙️) → All Settings (⚙️) → Sound → Sound Output → Bluetooth Speaker List)
- The TV CONNECT feature may be turned off. While the soundbar is in **"BT READY"**, press and hold the **Left** button on the Soundbar Remote Control for 5 seconds to select **ON-TV CONNECT**. If you see **OFF-TV CONNECT**, press and hold the **Left** button for 5 seconds to switch the selection.

LED indicator	Status
 Cyan blinking x1	ON-TV CONNECT
 Red blinking x1	OFF-TV CONNECT

- Disconnect the power plug, connect it again, and then try again.
- Reset the soundbar and try again. (See the ["Reset"](#) section.)

When the audio stutters due to a weak Bluetooth connection

- Audio may stutter if the soundbar is placed near an electronic device or appliance that causes radio interference. (e.g., microwave oven, wireless router, etc.)
- The sound may cut out if the connected device is too far from the soundbar. Please move the device closer to the soundbar.
- If your body is in contact with the Bluetooth transceiver or the soundbar is placed on metal furniture, the audio may stutter. Check the installation environment and conditions.

When a Wi-Fi connection can't be established

- Check whether your wireless router is on.
- Turn off the router, turn it back on, and then try to reconnect.
- If the wireless router signal is weak, a Wi-Fi connection may not be possible. Move the wireless router closer to the soundbar or place it in an unobstructed location.
- If you have installed a new wireless router, you'll need to reconfigure the speaker's network settings. (See the ["To change your Wi-Fi \(wireless network\)"](#) section.)
- The soundbar doesn't support Wi-Fi 6.

When the TV is powered on, but the soundbar doesn't turn on together with it

- When you turn off the soundbar first while watching TV, the Auto Power Link on the soundbar will also be turned off. Power off the TV first.

My TV and soundbar are connected, but when I switch to soundbar mode, no audio is played through the TV speakers.

- If you connect your mobile device to the soundbar while it is connected to a TV and audio is playing, the audio output will switch to your mobile device's, but the soundbar will remain connected to the TV.
- When you end the connection between your mobile device, the soundbar will play the TV audio.

If the soundbar does not appear in the list of AirPlay-compatible devices

- Ensure that you have agreed to the terms of use for the [Samsung Sound](#) app and register the device. (See the ["Connecting to Apple AirPlay"](#) section.)
- Ensure that the soundbar is not deleted from the [Samsung Sound](#) app.
- Check and see if your soundbar and your Apple devices are connected to the same Wi-Fi network.
- Note that iOS version 13.4 or later is required.

Group Play isn't activated.

- Check that your audio device is a new model released in 2024 or later.
- Check to make sure that the host device, which is the source, is connected to the Wi-Fi network.
- The audio devices must be connected to the same Wi-Fi network (5GHz).

13 Licenses & Other Information



Dolby, Dolby Atmos, and the double-D symbol are registered trademarks of Dolby Laboratories Licensing Corporation. Manufactured under license from Dolby Laboratories. Confidential unpublished works.
Copyright © 2012-2026 Dolby Laboratories. All rights reserved.



Manufactured under license from DTS, Inc. and/or its affiliates. For patents, see <https://xperi.com/dts-patents/>. DTS, the DTS logo, DTS:X, and the DTS:X logo are trademarks or registered trademarks of DTS, Inc. and/or its affiliates in the U.S. and/or other countries. © DTS, Inc. and/or its affiliates. All rights reserved.

- This license may not be supported depending on the model or geographical area.
-



The terms HDMI, HDMI High-Definition Multimedia Interface, HDMI Trade dress and the HDMI Logos are trademarks or registered trademarks of HDMI Licensing Administrator, Inc.



Apple®, AirPlay®, iPad®, iPhone®, and Mac® are trademarks of Apple Inc., registered in the U.S. and other countries and regions.



- Use your phone, tablet or PC as a remote control for Spotify. Go to spotify.com/connect to learn how.
 - The Spotify software is subject to third party licenses found here. <https://www.spotify.com/connect/third-party-licenses>
-



Being Roon Ready means that Samsung and Roon streaming technology can be used together for an incredible user interface, simple setup, rock-solid daily reliability, and the highest levels of audio performance without compromise.

Open Source License notice

To learn more about the open source code used in this product, go to the following website (<http://opensource.samsung.com>).
