

DES

OUTDOOR GRILL

BH1-30R, BH1-36R, BH1-48R, BH1-36RI, BH1-48RI, BH1-48RS,
BH1-30, BH1-36, BH1-48 and BGC30 models

USER GUIDE

US CA

⚠ DANGER

IF YOU SMELL GAS

- Shut off gas to the appliance.
- Extinguish any open flame.
- Open lid.
- If odor continues, keep away from the appliance and immediately call your gas supplier or your fire department.

⚠ WARNING!

- Do not store or use gasoline or other flammable liquids or vapors in the vicinity of this or any other appliance.
- An LP cylinder not connected for use must not be stored in the vicinity of this or any other appliance.

CONTENTS

Safety and warnings	4
Installation requirements for Natural Gas	12
Product overview	13
Control panel	15
Planning your cook	16
Setting up the grill	18
Using the grill	19
Using the sear burner (some models only)	20
Using the side burners (some models only)	22
Using the smoker (some models only)	23
Using the grates	24
Using the rotisserie (Some models only)	26
Accessories	29
Cleaning	30
Cleaning the grill burners	31
Cleaning the sear burner	32
Cleaning the side burners	34
Leak testing	35
Changing the gas cylinder	36
Replacing the light and battery	37
Resetting flow limiting device	38
Troubleshooting	39
Customer care	41

Registration

To register your product visit our website:

USA: dcsappliances.com/us/register

Canada: dcsappliances.com/ca/register

SAFETY AND WARNINGS

To reduce the risk of fire, electrical shock, injury to persons, or damage when using the appliance, follow the important safety instructions listed below:

⚠ WARNING!

Hot Surface Hazard

Failure to follow this advice may result in burns and scalds or serious injury.

- Accessible parts may become hot during use.
- Hood must be opened before lighting the grill.
- Never let clothing or other flammable materials come in contact with or get too close to any grate, burner or hot surface until it has cooled. Fabric may ignite and result in fire or personal injury. Keep outdoor cooking gas appliance area clear and free from combustible materials, gasoline and other flammable vapours and liquids.
- Never lean over an open grill. When lighting a burner, always pay close attention to what you are doing. Be certain you are pushing the burner knob when you attempt to light the grill.
- When using the grill, do not touch surfaces such as grill burner, grate, or immediate surrounding areas as these become extremely hot and could cause burns.
- Grease is flammable. Never operate the grill without a drip tray. Let hot grease cool before attempting to handle it. Avoid letting grease deposits collect in the drip pan. Clean the grill with caution. Avoid steam burns; do not use a wet sponge or cloth to clean the grill while it is hot. Some cleaners produce noxious fumes or can ignite if applied to a hot surface.



⚠ WARNING!



Hot Surface Hazard

Failure to follow this advice may result in burns and scalds or serious injury.

- Use only dry pot-holders; moist or damp pot-holders on hot surfaces may cause burns from steam. Do not use a towel or bulky cloth in place of pot-holders. Do not let pot-holders touch hot portions of the grill or burner grate.
- To avoid burns when cooking, use long handled BBQ tools.

⚠ WARNING!



Explosion Hazard

Failure to follow this advice may result in injury or death.

- If you smell gas, do not use the appliance.
- Do not use water on grease fires, a violent steam explosion may result. Turn all burners off, then smother fire use dry chemical or foam-type extinguisher.
- Do not heat unopened food containers such as cans - Build up of pressure may cause container to burst and result in injury.
- Leaking LP gas can cause a fire or explosion if ignited causing serious bodily injury or death.
- Contact LP gas supplier for repairs or disposal of the cylinder or unused LP gas.

SAFETY AND WARNINGS

⚠ WARNING!



Cut Hazard

Failure to use caution could result in injury.

- Take care: some edges are sharp.

⚠ WARNING



Excessive Weight Hazard

Failure to follow this advice may result in injury or death.

- Two or more people are required to move and install this unit.

⚠ WARNING



Electrical Shock Hazard

Failure to follow this advice may result in death or electrical shock.

- This appliance is equipped with a three-prong grounding plug for your protection against shock hazard and should be plugged directly into a properly grounded power outlet.
- Use only a Ground Fault Interrupter (GFI) protected circuit.
- Use only extension cords with a three-prong grounding plug, rated for the power of the equipment, and approved for outdoor use with a W-A marking.
- Do not immerse cord or plugs in water or other liquid.
- Do not under any circumstances cut or remove the grounding prong from this plug.

⚠ WARNING!

Fire Hazard

Failure to follow this advice may result in death or serious injury.

- Do not operate the grill under unprotected combustible construction. Use only in well ventilated areas.
- Cylinders shall be stored outdoors and out of the reach of children.
- Do not store in a building, garage or any other enclosed area.
- An appliance is considered to be outdoors if installed with shelter no more inclusive than within a partial enclosure that includes an overhead cover and three side walls, as long as 30% or more of the periphery of the enclosure is permanently open.
- All openings must be permanently open; sliding doors, garage doors, windows, or screened openings are not considered as permanent openings.
- Never leave the grill unattended when in use.
- Never store a spare LP cylinder under or near this unit.
- Never fill the cylinder beyond 80 percent full.
- If the information above is not followed exactly, a fire causing death or serious injury could occur.



SAFETY AND WARNINGS

To reduce the risk of fire, injury to persons or damage when using the appliance, follow the important safety instructions listed below. Read all the guidance before using the appliance. Do not use an outdoor cooking gas appliance for purposes other than intended.

General Use

- When using the appliance, be sure that all parts of the unit are firmly in place and that everything is stable.
- Do not locate, store, or operate the appliance on a slope.
- Do not move the appliance during use. On cart mounted units, never move cart without first allowing the appliance to cool, disconnecting the power cable, and ensuring that the gas supply is turned off.
- Children should not be left alone or unattended in an area where the product is being used. Never allow them to sit, stand or play on or around the unit at any time. When in use, portions of the grill are hot enough to cause severe burns.
- Do not store items of interest to children around or below the appliance.
- Never use the appliance in a windy area.
- Do not obstruct the flow of combustion and ventilation air to the appliance.
- To put out flare-ups, adjust the controls to lower the temperature.
- Clean and perform general maintenance on the appliance regularly and after periods without use. Always turn off gas at the source prior to inspecting.
- Ensure all grill controls are turned off and the grill is cool before using any type of aerosol cleaner on or around the grill. The chemical that produces the spraying action could, in the presence of heat, ignite or cause metal parts to corrode.
- Unplug from the outlet when not in use and before cleaning. Allow to cool before putting on or taking off parts.
- Before each use, inspect the gas supply piping or hose prior to turning the gas "ON". If there is evidence of cuts, wear, or abrasion, it must be replaced prior to use.
- You must inspect the unit at least once a year. Check immediately if the smell of gas is present or the burner flames appear yellow, the appliance does not reach temperature or heats unevenly, or the unit makes popping noises.
- When refitting each burner after cleaning, correctly center the burner onto the gas jet and ensure it is level before lighting.
- When connecting to a power supply, first connect plug to the appliance, then plug appliance into the outlet.
- Do not try lighting this appliance without reading the lighting instructions in this guide.
- After lighting burners, make sure burners are operating normally. In sunny locations, it may be difficult to see when the rotisserie and sear burners are lit. Use caution.
- The sear burner is designed specifically for searing food. Do not use the griddle plate or charcoal insert over the sear burner or cover it with any utensil type.
- Do not place griddle plates side by side on the grill.
- Do not operate in enclosed areas. This could result in carbon monoxide build-up which could result in injury or death.
- This product must be installed by a licensed plumber or gas fitter when installed within the Commonwealth of Massachusetts.

SAFETY AND WARNINGS

Fire

- Have an ABC rated fire extinguisher accessible – never attempt to extinguish a grease fire with water or other liquids.
- Never leave the product unattended when in use.
- Always remove dust cover and open hood before lighting. Do not replace cover during cooking or before appliance has cooled.
- Do not use a flame to check for gas leaks.
- Do not smoke while leak testing.
- Do not attempt to disconnect any gas connections while your appliance is in use, or the gas supply is on.
- Never connect an unregulated gas line to the appliance.

Electrical Hazards

- Do not operate with a damaged cord or plug, after the appliance malfunctions or after the appliance has been damaged in any manner. Contact the manufacturer for repair.
- Keep any electrical supply cord, the rotisserie motor cord and the fuel supply hose away from the heated areas of the grill, sharp edges and water (pools, fountains, puddles).
- When connecting, first connect plug into the appliance and then plug appliance into the outlet.
- Do not let the cord hang over the edge of a table or touch hot surfaces.

Installation Warnings

- The installation of this appliance must conform with local codes or, in the absence of local codes, with the National Fuel Gas Code, ANSI Z223.1/NFPA 54. Installation in Canada must be in accordance with Natural Gas and Propane Installation Code, CSA B149.1, and/or Propane Storage and Handling Code, B149.2 and local codes.
- This appliance must be electrically grounded in accordance with local codes, or in the absence of local codes, with NFPA 70 or the Canadian Electrical Code, Part I.
- This appliance must only be used outdoors and must not be used in a building, garage or any other enclosed area.
- An appliance is considered to be outdoors if installed with shelter no more inclusive than within a partial enclosure that includes an overhead cover and three sidewalls, as long as 30% or more of the horizontal periphery of the enclosure is permanently open. All openings must be permanently open; sliding doors, garage doors, windows, or screened openings are not considered as permanent openings.
- Do not use this appliance under overhead combustible surfaces.
- All gas connections, installations and leak testing should be made by a qualified technician.
- Installation must comply with clearances to combustible materials as noted in the Planning Guide.
- Do not attempt to remove, repair, or replace the regulator/hose assembly. This must be done by a qualified licensed technician only. The grill system arrives leak tested.
- If the connections are not perfectly sealed, you can have a small leak and therefore a faint gas smell. Some leaks can only be found with the burner control in the “ON” position - this must be done by a qualified technician.
- Keep the ventilation openings of the cylinder enclosure free and clear from debris.
- This outdoor cooking gas appliance is not intended to be installed in or on recreational vehicles, trailers and/or boats.

SAFETY AND WARNINGS

Gas Requirements

- Do not change the regulator/hose assembly from that supplied with the unit or attempt to use a Type 1 equipped regulator/hose assembly with a standard 510 POL cylinder/valve assembly.
- The cylinder pressure relief valve outlet must point away from the user when in use.
- An installer-supplied gas shut-off valve must be installed in an easily accessible location.
- All installer-supplied parts must conform to local codes, or in the absence of local codes, with the National Electrical Code, ANSI/NFPA 70 or the Canadian Electrical Code, CSA C22.1, and the National Fuel Gas Code, ANSI Z223.1 or CSA-B149.1 Natural Gas Installation Code or CSA-B149.2 Propane Installation Code.
- In Massachusetts such shut-off valves should be approved by the Board of State Examiners or Plumbers & Gas Fitters.
- All pipe sealants must be an approved type and resistant to the actions of LP gases. Never use pipe sealant on flare fittings.
- A dented or rusty LP cylinder may be hazardous and should be checked by your LP supplier.
- Always check for leaks after every LP cylinder change. Check with a full cylinder.
- Do not use the appliance until all connections have been checked and do not leak.
- Before each use, inspect the gas supply piping or hose prior to turning the gas ON. If there is evidence of cuts, wear, or abrasion, it must be replaced prior to use.
- The pressure regulator and hose assembly supplied with the appliance must be used. If replacements are needed, contact Customer Care.

Storage and maintenance

- Ensure the gas supply is turned off at the supply cylinder when not in use.
- Keep appliance covered when not in use.
- Storage of the appliance indoors is permissible only if the cylinder is disconnected and removed from the unit.
- Cylinders must be stored outdoors, out of reach of children and must not be stored in a building, garage, or any other enclosed area.
- After a period of storage or non-use, the appliance should be checked for gas leaks, deterioration, proper assembly, and burner obstructions before use.
- Keep the outdoor gas appliance area clear and free from combustible materials, gasoline, and other flammable vapours and liquids.
- Clean the outdoor gas appliance, including special surfaces with recommended cleaning agents and check burner/venturi tubes for insects and insect nests. A clogged tube can lead to a fire beneath the grill.

LP Cylinder Cabinet Requirements

For a cylinder enclosure having four sides, a top and a bottom, and intended for installation in a built-in enclosure:

- At least one ventilation opening shall be provided on the exposed exterior side of the enclosure located within 5" (127mm) of the top of the enclosure and unobstructed. The opening(s) shall have a total free area of not less than 1¹/₂"²/lb (14.2cm²/kg) of stored fuel capacity.
- At least one ventilation opening shall be provided on the exposed exterior side of the enclosure 1" (25.4mm) or less from the floor level and shall have a total free area of not less than 1/2¹/₂"²/lb (7.1cm²/kg) of stored fuel capacity. The upper edge shall be no more than 5" (127mm) above the floor level.
- Every opening shall have a minimum dimension so as to permit the entrance of a 3/16" (4.8mm) rod.

SAFETY AND WARNINGS

LP Cylinder Hazards

- Installation must conform with local codes or with the National Fuel Gas Code ANSI Z223.1 or the CSA-B149.2 Propane Installation Code.
- This appliance can be used with any brand of 20 lb LP gas cylinder provided it is compatible with a proper retention device (not supplied for built-in installations).
- The LP gas cylinder must be:
 - Designed for use with a Type 1 system only.
 - Constructed and marked in accordance with the Specifications for LP gas Cylinders of the U.S. Department of Transportation (D.O.T.) or the Standard for Cylinders, Spheres and Tubes for Transportation of Dangerous Goods and Commission, CAN/CSA-B339.
 - Provided with a listed overfilling prevention device.
 - Provided with a cylinder connection device compatible with the connection for outdoor cooking gas appliances.
- The cylinder must be provided with a shut-off valve terminating in an LP gas supply cylinder valve outlet specified, as applicable, for connection Type 1.
- Do not store a full cylinder in direct sunlight.
- Never use a cylinder with a damaged valve. Always check for leaks after every combustible gas cylinder change.
- The cylinder that is used must have a collar to protect the cylinder valve.
- If you intend to operate your built-in grill on LP gas utilizing a 20 lb Type 1 cylinder, an installer supplied built-in LP cylinder restraint must be installed prior to initial use of the grill.
- Gas piping and connectors must be clamped within the enclosure to avoid contact with moving parts and hot surfaces. Where the gas piping passes through an opening in the enclosure, the piping must be protected for a distance of at least 2" (50 mm) either side of the opening.
- Connection: LP gas hose with a Type 1 quick disconnect and regulator is included.
- Operating pressure: 11.0" W.C.
- All gas piping and connectors must conform to the Standard for Connectors for Outdoor Gas Appliances and Manufactured Homes, ANSI Z21.75/CSA 6.27.
- If the appliance is stored indoors, the cylinder must be disconnected and removed from the appliance.
- Grills orificed for use with combustible gas come equipped with a high-capacity hose/regulator assembly for connection to a standard 20 lb. combustible gas cylinder (Type 1). The combustible gas cylinder is not included.
- Do not use the grill until all connections have been checked and do not leak.
- If you own or use a spare cylinder, or have a disconnected cylinder, you should NEVER store it near or under the grill unit or heat box, or near any other ignition or heat source.
- Never fill the cylinder beyond 80% full.
- If the information above is not followed exactly, a fire causing death or serious injury could occur.

INSTALLATION REQUIREMENTS FOR NATURAL GAS

Natural gas Installation and connection

- Check with your local gas utility company or local codes for instructions on installing gas supply lines. Be sure to check on type and size of run, and how deep to bury the line. If the gas line is too small, the grill will not function properly. Any joint or pipe sealant used must be an approved type and be resistive to the actions of combustible gases.
- Ensure that the regulator arrow points in the direction of gas flow away from the gas supply.
- The appliance and its individual shut-off valve must be disconnected from the gas supply piping system during any pressure testing of that system at test pressures in excess of 1.2 psi (3.5 kPa).
- The appliance must be isolated from the gas supply piping system by closing its individual manual shut-off valve during any pressure testing of the gas supply piping system at test pressures equal to or less than 1/2 psi (3.5 kPa).
- An installer-supplied gas shut-off valve must be installed in an easily accessible location.
- Use threading compound on male threads only.
- Never use pipe sealant on flare fittings.
- In Massachusetts such shut-off valves must be approved by the Board of State Examiners or Plumbers & Gas Fitters.
- All piping and hoses are to run away from the product and never against the product surfaces.
- Natural Gas: Operating pressure: 4.0" W.C. Supply Pressure 5" to 14" W.C. If in excess of 14", a stepdown regulator supplied by installer is required.
- All gas piping and connectors must conform to the Standard for Connectors for Outdoor Gas Appliances and Manufactured Homes, ANSI Z21.75/CSA 6.27.

Total gas consumption of the grill with all burners on HI - Input rates BTU/hr

MODEL	BH1-30R	BH1-36R	BH1-48R	BH1-36RI	BH1-48RI	BH1-48RS	BH1-30	BH1-36	BH1-48	BGC30
MAXIMUM	64000	92500	121500	88000	117000	126500	50000	78500	103500	50000
GRILL	25000	25000	25000	25000	25000	25000	25000	25000	25000	25000
ROTISSERIE	14000	14000	18000	14000	18000	14000	N/A	N/A	N/A	N/A
SEAR	N/A	N/A	N/A	24000	24000	N/A	N/A	N/A	N/A	N/A
SIDE BURNER	N/A	N/A	N/A	N/A	N/A	34000	N/A	N/A	N/A	N/A
SMOKER	N/A	3500	3500	N/A	N/A	3500	N/A	3500	3500	N/A

Servicing

- Do not repair or replace any part of the appliance unless specifically recommended in this guide. All other servicing should be undertaken by an authorized technician or qualified person.
- Only use the product with the type of gas specified on the rating plate. To change gas type, a factory conversion kit is required.

PRODUCT OVERVIEW



BH1-48RI model illustrated.

Features and accessories

- | | |
|----------------------------------|---------------------------------------|
| ① Sear burner* | ⑦ Rotisserie rod* |
| ② Grill burners | ⑧ Rotisserie light* |
| ③ Control panel | ⑨ Rotisserie motor* |
| ④ Drip tray and removable insert | ⑩ Secondary cooking area |
| ⑤ Temperature gauge | ⑪ Tray (not shown) |
| ⑥ Rotisserie burner* | ⑫ BGC30 model: Ignition button |



*Some models only

PRODUCT OVERVIEW



BHI-48RS model illustrated.

Features and accessories

- | | |
|----------------------------------|--------------------------|
| ① Side burners* | ⑦ Rotisserie rod* |
| ② Grill burners | ⑧ Rotisserie light* |
| ③ Control panel | ⑨ Rotisserie motor* |
| ④ Drip tray and removable insert | ⑩ Secondary cooking area |
| ⑤ Temperature gauge | ⑪ Smoker tray* |
| ⑥ Rotisserie burner* | ⑫ Tray (not shown) |

*Some models only

CONTROL PANEL



BH1-48RI model.



BH1-48RS model.

Control panel

① Sear burner dial*	Use to ignite sear burner and select heat setting.
② Grill burner dials	Use to ignite grill burners and select heat settings.
③ Rotisserie dial*	Use with rotisserie safety valve to ignite rotisserie burner and to select heat setting.
④ Rotisserie safety valve*	Allows safe gas flow to rotisserie burner while lighting. Use with rotisserie burner dial to ignite rotisserie burner.
⑤ Side burner dials*	Use to ignite side burners and select heat settings.
⑥ Smoker burner dial*	Use to ignite smoker burner and to select heat setting.

*Some models only

PLANNING YOUR COOK

Before using the grill, plan what you want to cook and how you want to cook it.

The grill design allows you to tailor your cook with different cooking methods, areas and grate types. For optimal results, take advantage of the entire grill to move food between high and low heat zones at different stages of the cook.



Direct grilling

Food is cooked on grates directly over lit burners.

Use this method for food that takes less than 20 minutes to cook or for searing larger items before indirect cooking or further grilling at a lower heat setting.



Indirect cooking

Food is cooked on grates beside the heat source, with hood closed to maintain heat.

Use for food that takes longer than 20 minutes to cook such as thicker pieces of meat.



Sear burner (some models only)

Delivers intense, even heat that builds flavor and texture. Use only with the sear burner grate to create perfect sear lines and surface browning.

Sear meat at a high heat, then move to a lower heat zone before resting to achieve required doneness. Switch order for reverse-sear method. See 'Using the sear burner.'

PLANNING YOUR COOK



Grill burners

The grill burners deliver a range of heat intensities. Choose cooking zones and heat settings to cook a variety of foods using direct or indirect heat.

Use with radiant trays and double-sided grates to cook and brown food. See 'Using the grates.'



Side burners

Use the side burners to heat, boil or stir fry food.



Rotisserie (some models only)

Use the rotisserie to slowly cook food. Intense, even heat gives roasts a crust. See 'Using the rotisserie.'

SETTING UP THE GRILL

Before you begin

- Inspect the gas piping or hose for signs of cuts, wear or abrasion before each use. Replace any damaged parts before using the grill.
- Season the grates. See 'Using the grates.'



1. Ensure all dials are turned off, then lift the grill hood.



2. Position the grates and secondary cooking rack according to your cooking plan. If using the rotisserie, set this up first. See 'Using the rotisserie.'



3. Pull drip tray out to check insert is clean and in place before pushing tray back in. Turn on the main gas supply.

USING THE GRILL

Preheating the grill

Preheat each zone according to the heat settings you plan to cook at. There will be minimal heat bleed from high heat to low heat zones.

Use high heat for searing and browning, and medium, low or indirect heat to cook food through without burning.



Lighting the grill

1. Light one burner at a time. Push and turn dial to **SEAR** to ignite.

BGC30 model: Push and hold the **IGNITION** button, turn the selected burner knob to **SEAR**.

The ignitor will make a clicking sound. Once lit, turn dial to desired heat and release. If burners do not light, wait 5 minutes for gas to dissipate, then start again or light manually.



2. Light remaining grill burners, and select heat. Close hood and leave grill to preheat for 10 minutes, or longer if preheating to low heat setting.

If not using all burners, preheat planned burners and any adjacent burner at desired heat for 10 minutes.



Manual lighting

Turn dial to **SEAR**. At the same time, hold a lit match or lighter slightly below the opening on the side of the grill.

When burner ignites, turn dial to desired heat setting and release it. Remaining grill burners will cross light, but sear burner will not.

Do not use lighter fluid.

USING THE SEAR BURNER (SOME MODELS ONLY)



1. Make sure the sear burner grate is secured in the hooks at the back of the grill, with its legs on the ledge at the front.



2. Light one burner at a time. Push and turn dial to **MAX** to ignite. Light adjacent burner and set to **SEAR**. Light and set remaining burners as desired.

Preheat for 10 minutes with hood down. Preheat for 5 minutes if sear burner is already warm.

If burner does not light, wait 5 minutes for gas to dissipate, then start again or light manually.



3. Once burner is preheated, place food on the grate. If only using sear burner, turn off adjacent burner after preheat.

The sear burner produces intense heat. We recommend keeping a close eye on food and turning it frequently. Adjust heat setting if required.

USING THE SEAR BURNER (SOME MODELS ONLY)



4. Once browned, move the food to another area of the grill to finish cooking, if required. Turn sear burner dial to **OFF**.



Manual lighting

Turn dial to allow gas to flow. At the same time, hold a long match or lighter to the side of the sear burner, in the gap between grates.

When burner ignites, turn dial to desired heat setting, and release it.

USING THE SIDE BURNERS (SOME MODELS ONLY)



1. Remove rotisserie rod and the side burner cover. Take care if grill is in use, as rod and cover may be hot.



Lighting the side burners

2. Light one burner at a time. Push and turn dial to HI to ignite.

The ignitor will make a clicking sound. Once lit, turn dial to desired heat and release.

If burners do not light, wait 5 minutes for gas to dissipate, then start again or light manually.



Manual lighting

Turn dial to allow gas to flow. At the same time, hold a long match or lighter to the side of the burner.

When burner ignites, turn dial to desired heat setting, and release it.

USING THE SMOKER (SOME MODELS ONLY)

Use the smoker tray for short-time smoking or to add smoky flavor to food when used on its own or with grill burners or rotisserie. When using the smoker system with the rotisserie burner, set smoker burner to **LOW** to minimize the heat transfer to the rotisserie tray or position the meat away from the smoker burner.



1. Remove the smoker tray.



Lighting the smoker

2. Push and turn smoker burner dial to **HI**. Watch through opening to see when burner ignites, then release dial.

If burner does not light, wait 5 minutes for gas to dissipate, then start again, or turn dial to **HI** and hold a lit match through the opening.



3. Fill the smoker tray with woodchips, place the lid on, then refit the tray in the grill. Once woodchips start to smoke, turn dial to desired heat setting.

In case of flare-ups, carefully add water through the grate or pull tray out slightly and add water through smoker lid.

Do not fully remove the tray while hot.

USING THE GRATES

Seasoning the grates

Season all grates before use to protect surface from corrosion and to stop food sticking. Repeat after cleaning or after long periods without use.



1. Apply a light coating of high-heat cooking oil to all grates, then heat on **MAX/SEAR** with the hood down. See 'Lighting the grill'.



2. Turn the dials **OFF** after 15 minutes or when grates begin to smoke. Allow to cool.

Grates will change color. This is normal.



Sear burner grate

Designed for fast, even searing and clean sear lines.

Fits flat over sear burner. Rests on hooks at rear of grill.

USING THE GRATES

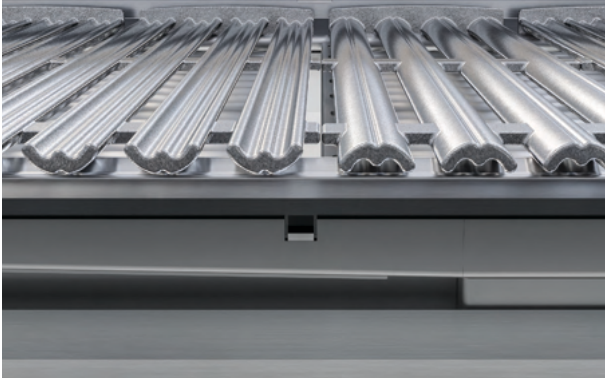

Double-sided grates

Use W-shaped side to create sear lines on food and channel juice and grease away from flame. Use the radius side to support and cook delicate food items like scallops and salmon.

USING THE ROTISSERIE (SOME MODELS ONLY)

The rotisserie delivers intense and even heat to food to achieve a crust on roasts or to slowly cook large food items up to 50 lb.

Do not ignite the grill burners while the rotisserie burner is lit. Avoid using the rotisserie in windy conditions.

Tying meat and poultry

Use butcher string or dental floss to tie meat and poultry before putting them on the rotisserie rod.

We recommend selecting a roast that is a consistent size and tying it in three areas to ensure even cooking. For poultry, tie the wings and legs to the body to secure them while the rotisserie is turning.



Preparing the rotisserie rod

1. Remove the secondary cooking rack.

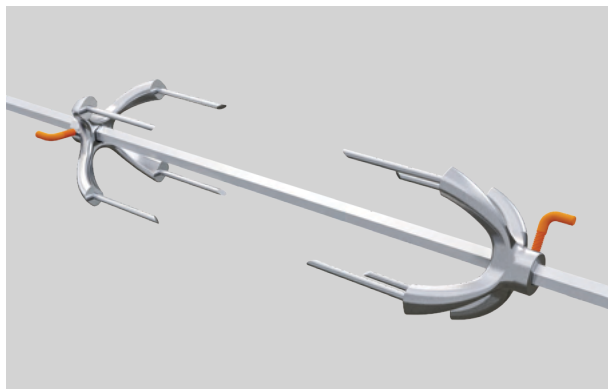

2. Slide first fork onto rotisserie rod far enough to allow food to be centered. Turn the L-shaped screw to secure it.

Slide food and second fork onto rod, with fork tines offset. Turn screw to secure.

Forks are sharp. Take care when handling.

USING THE ROTISSERIE (SOME MODELS ONLY)



3. Insert sharp end of rod into rotisserie motor. Rest other end on rollers at opposite side of grill.

Rod does not rest on rollers next to motor.



5. Place the tray beneath food to collect drips. Switch on rotisserie motor.

If required, switch off to adjust food for balance, and remove grates to create more space between food and tray.



Lighting the rotisserie

4. Light one burner at a time. Push and turn dial to **HI** and, at the same time, press and hold the safety valve button for 10 seconds or until burner remains lit.

Once lit, turn dial to desired heat setting and release.

USING THE ROTISSERIE (SOME MODELS ONLY)



Manual lighting

Hold lighter to side of burner, then push and turn dial to **HI**. Release the dial, and press and hold the safety valve button for 10 seconds or until burner ignites.

Turn dial to desired heat.



Checking food temperature

Turn dial to **LOW**, switch off motor, and use a meat thermometer. If further cooking is required, turn dial to desired heat and restart motor.

When food is cooked, turn dial to **OFF**, and switch off motor. Remove rod, place food on a tray, then remove forks. Take care, as rod will be hot.

Cover and allow to rest.

ACCESSORIES



USA

For a complete list of accessories, scan the QR code or visit dcsappliances.com/us/accessories.



Canada

For a complete list of accessories, scan the QR code or visit dcsappliances.com/ca/accessories.

CLEANING

General

Clean your grill regularly, and after periods without use, to maintain performance.

Stainless steel surfaces

Clean regularly with mild detergent, kitchen spray or stainless steel cleaner to maintain condition, especially if located near a pool or the coast. Cover when not in use.

Secondary cooking rack

Allow to cool, then remove from grill and wash with hot water and mild detergent.

Grates

While still hot and on grill, brush residue off with a grill brush. When cold, clean with hot water and mild detergent, then dry with a soft, clean cloth.

Re-season grates after cleaning to prevent rust.

Drip tray

Allow to cool. Clean after each use to prevent grease build-up. Dishwasher safe.

Rotisserie rod and forks

Clean with hot water and mild detergent, and dry with a soft, clean cloth. Take care when handling forks, as they are sharp.

Smoker tray

Do not touch or move the tray while hot. Scrape off food residue and use a brush to clean the bottom of the tray. Dispose of the ash in a fireproof container.

Grease Management System

Allow grease to set, then scrape it out. Wipe as needed.

Radiant trays

Rotate ceramic rods so they burn clean when next used. If required, use a brush to remove residue, or clean with hot water and mild detergent. For heavy soiling, heat radiant tray on HI for 10–20 mins. Trays may smoke. This is normal. Do not take trays apart.

Rotisserie burner

Self cleaning. Run the rotisserie burner for 10–20 minutes to burn off any residue. Do not use water.

CLEANING THE GRILL BURNERS

Grill burners should be removed regularly for cleaning and to check for blockages from food residue and insects. Always turn off gas supply before removing and cleaning burners.

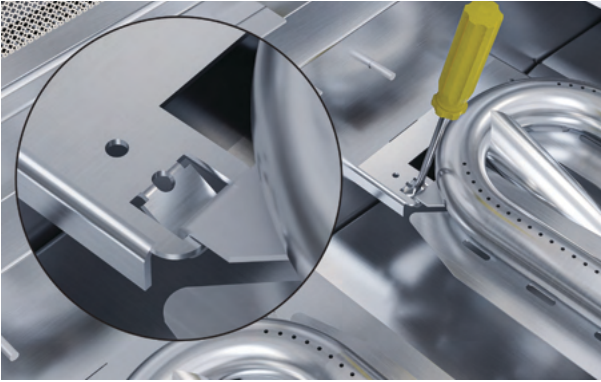

1. Remove grates and radiant trays. Use a flathead screwdriver to loosen clamps, then carefully lift burner up and out of grill.

Shake gently to remove debris. Clean exterior with a grill brush.

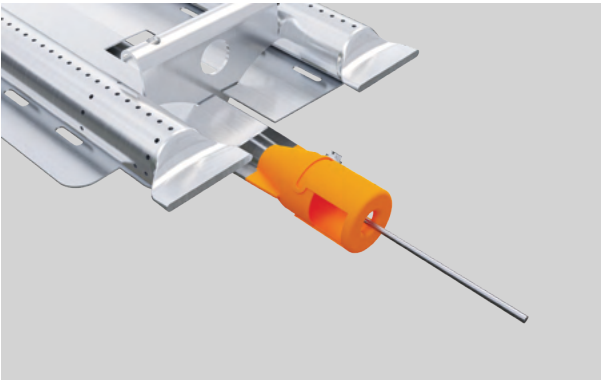

2. Use a flashlight to check if burner inlet is blocked. If so, use safety pin or straightened paper clip to unblock inlet and holes along burner tube.

You can unblock gas jet inside front of grill if required.

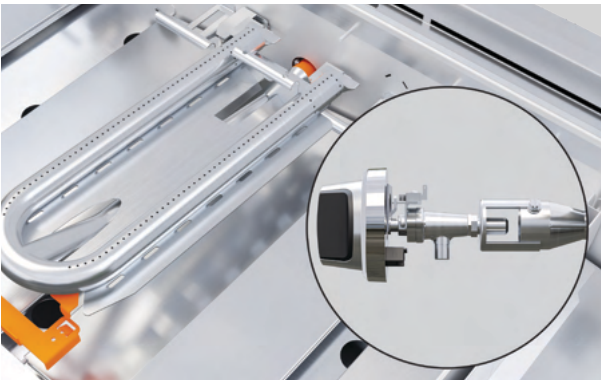

3. Refit burner so inlet is centered on gas jet, then lower burner onto mounts at rear. Ensure it is level and secure.

Take care not to damage ignitor.

Burner must be properly located to ensure safe operation.

CLEANING THE SEAR BURNER

Run the sear burner for 10–20 minutes, then allow to cool. The sear burner is self-cleaning, but it can be removed for further cleaning if required. Do not use water as it can damage the sear burner and affect its performance. Always turn off gas supply before removing and cleaning burners.

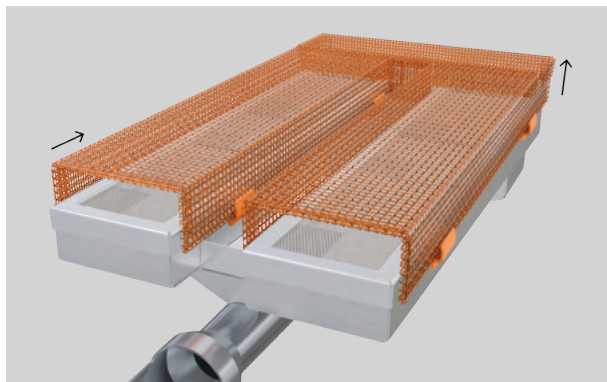

1. Unclip and remove mesh cover from sear burner. Brush or vacuum the mesh separately to remove any residue.

If required, rinse the mesh in warm water and dry thoroughly.

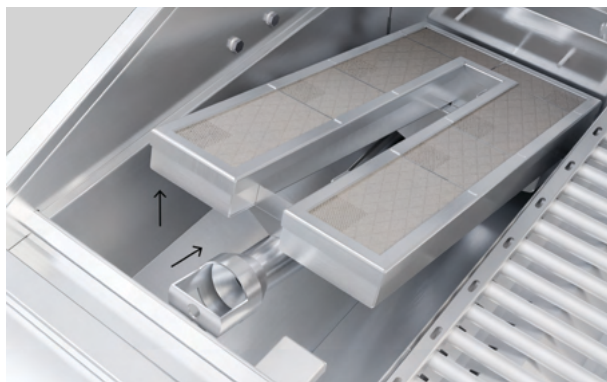

2. Hold burner at the sides and lift at the back to remove it from its mount.

Slide it towards rear of grill to separate it from the opening in the front of the grill, then lift burner to remove.

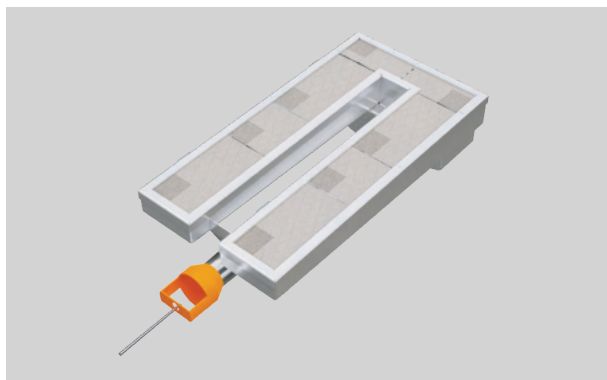

3. Check the burner inlet for blockages. Use a safety pin or paper clip to unblock it.

Gently shake or vacuum the burner to remove debris. Do not use a brush. Do not use water.

CLEANING THE SEAR BURNER

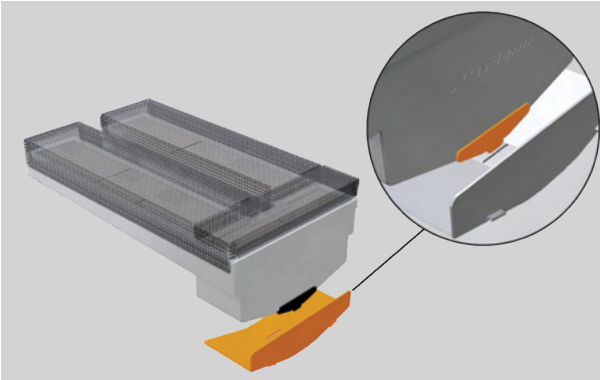

4. Hold sear burner at the sides and fit burner inlet back into opening at front of grill. Ensure it is aligned correctly on the valve inside the opening.

Lower at rear to refit it securely on mount. Refit mesh.

Burner must be properly located to ensure safe operation.

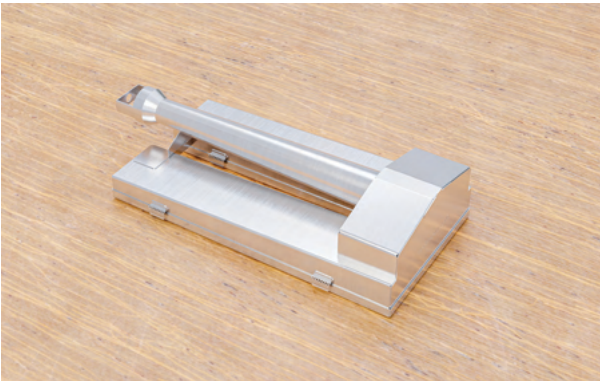

If sear burner gets wet

Remove the burner. Rest it upside down to allow water to drain.

Allow burner to dry completely before reinstalling and using.

CLEANING THE SIDE BURNERS

Side burners should be removed regularly for cleaning and to check for blockages from food residue and insects. Always turn off gas supply before removing and cleaning burners.



1. Allow to cool, then remove grate, burner caps and brass rings. Wash these with hot water and mild detergent. Dry thoroughly.

If required, use a brush to clean burner ports.

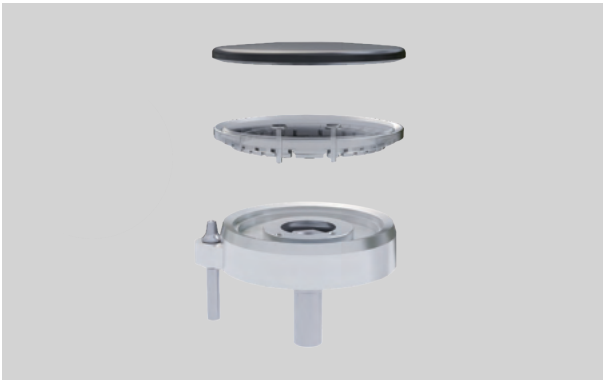

2. Refit brass ring so pins are aligned in the base of the burner. Place burner cap onto brass ring and ensure it is secure, then refit the grate.

Burners must be properly located to ensure safe operation.

LEAK TESTING

Do not smoke while leak testing, and extinguish all open flames. Check with a full cylinder and make sure all dials are **OFF**.

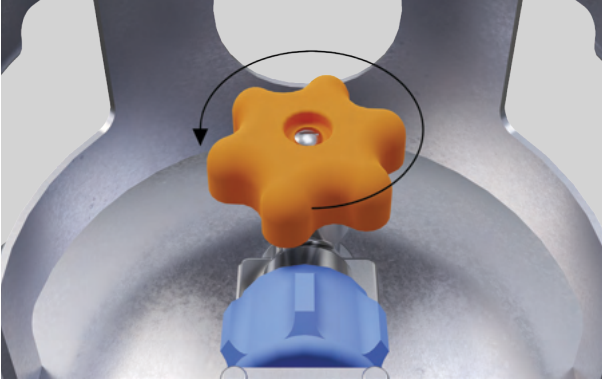

1. Open the gas cylinder valve.

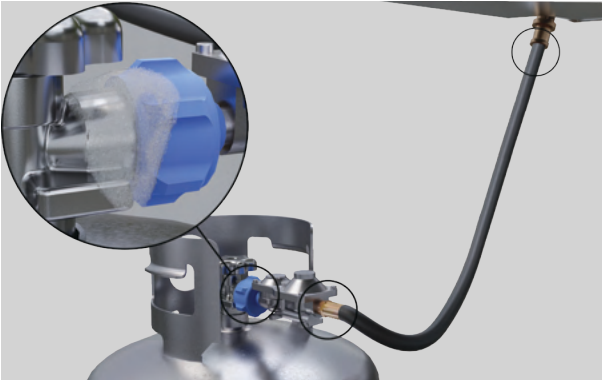

2. Apply a soap solution of 1:1 liquid soap and water to all connections, hoses and fittings from the cylinder to the connection at the grill.

Soap bubbles will appear where gas is escaping.

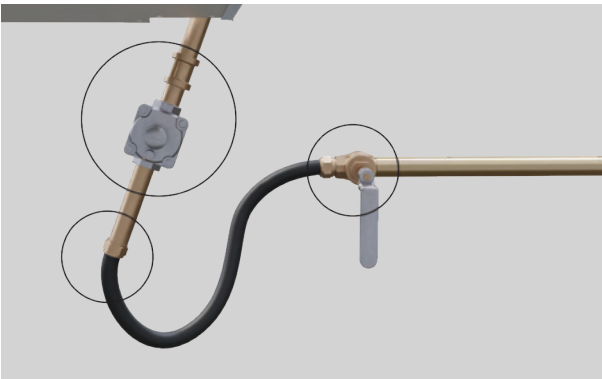

3. If leaking, turn gas off, tighten leaking connections and recheck.

If still leaking, turn gas off, and call your local gas utility or the dealer where you purchased the grill.

CHANGING THE GAS CYLINDER

Inspect the gas connection hose every time you change the gas cylinder. Replace hose if there are any signs of damage.



1. Before connecting new cylinder, check the rubber O-ring. If O-ring is damaged, return it to gas supplier. Do not use damaged cylinder.

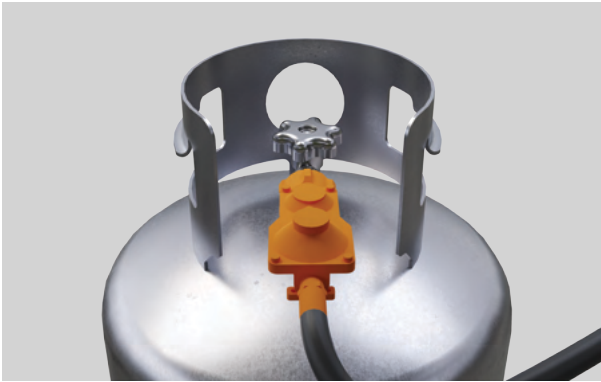

2. If O-ring is in good condition, connect the grill regulator to the gas cylinder valve and turn gas on. Check for leaks. See 'Leak testing.'

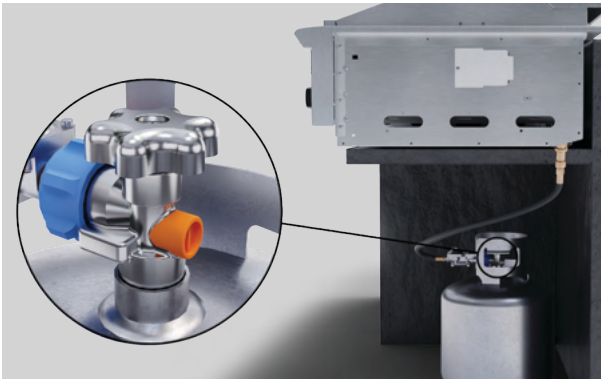

3. If there is no leak, place the cylinder into the grill cabinet with the pressure relief valve facing away from you. Always close the cylinder valve after each use.

REPLACING THE LIGHT AND BATTERY

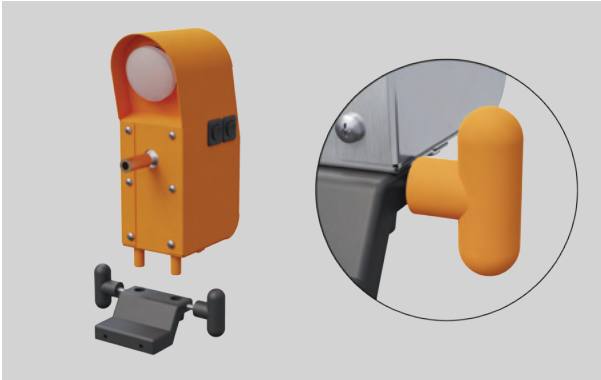

Replacing rotisserie light

1. Disconnect rotisserie motor from power supply. Loosen handles, and lift motor off grill.



2. Unscrew and replace light bulb. The rotisserie uses a 50W (or its equivalent) Max. Halogen Narrow bulb.

Refit motor to grill, tighten lugs and reconnect the power supply.



Replacing the battery

Remove the drip tray and pull battery downwards to remove. Use pliers if required.

Replace with new 9-volt battery.

RESETTING FLOW LIMITING DEVICE

The flow limiting device on the gas cylinder may activate if the cylinder gets cold or is low on gas. This can affect gas flow and heat output and will need to be reset.



1. Turn all burner dials to **OFF**.

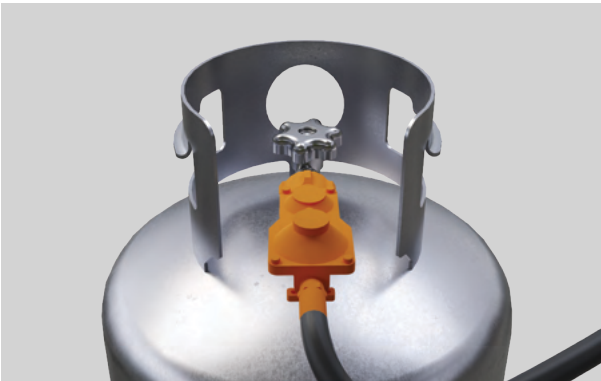

2. Close cylinder valve, and disconnect regulator hose from the cylinder.

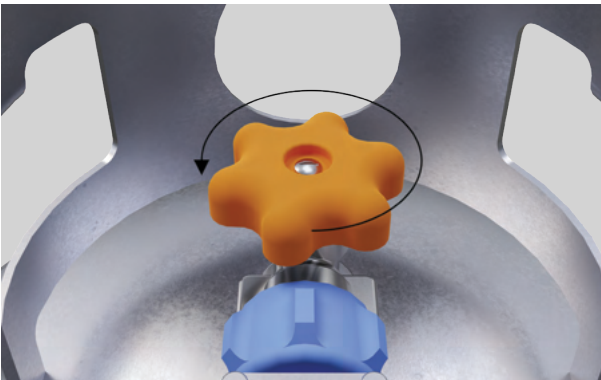

3. Reconnect regulator hose. Turn gas on with at least two full turns, and check for leaks. See 'Leak testing.'

TROUBLESHOOTING

Why is the burner flame yellow/orange?

Burner needs to be adjusted. See Install Guide.

Why won't the burners light when I turn the dial?

- Dial not pushed in when attempting to light grill. Push and turn to **SEAR/MAX**. See 'Using the grill.'
 - Gas supply is turned off. Turn gas on.
 - Burner inlet or tube may be blocked. Remove burner and check for blockages. See 'Cleaning the grill burners', 'Cleaning the sear burner' or 'Cleaning the side burners.' If problem persists, call Customer Care or your Authorized Service Center.
 - Ignitor battery is flat or ignitor has failed. Check if ignitor clicks when you push dial. If not, replace battery. See 'Replacing the light and battery.' If problem persists, call Customer Care or your Authorized Service Center.
-

Why does the grill keep having flare-ups?

- Radiant trays have grease on them. Wait for trays to cool, then rotate ceramic rods and heat on **HI** for 10-20 minutes. See 'Cleaning.'
 - Sear burner has grease on it. See 'Cleaning the sear burner.'
 - Rotisserie burner has grease on it. See 'Cleaning.'
-

Why can I smell gas?

- Burner dial is on but burner is not lit. Check the dial is turned to **OFF**. Wait 5 minutes before relighting. See 'Using the grill.'
 - Gas is leaking. See 'Leak testing.'
-

Why isn't grill getting hot on HI/SEAR?

- Grill hasn't preheated enough. Preheat for full 10 minutes before cooking.
 - Grill is being affected by wind gusts. Move to a more sheltered area if possible.
 - LP gas cylinder is empty. Check cylinder, and get it refilled if empty.
 - A burner port is obstructed. See 'Cleaning the grill burners', 'Cleaning the sear burner' or 'Cleaning the side burners.'
 - 'Flow Limiting Device is activated on LP cylinder. See 'Resetting flow limiting device.'
-

Why is there smoke coming from the grill?

Residue or grease on the grates or radiant trays. Brush residue off the grates with a grill brush. Residue on radiant trays should burn off during the cook. See 'Cleaning.'

TROUBLESHOOTING

Why isn't the rotisserie staying lit when I release the safety valve button? (some models only)

Releasing button too soon. Keep pressing the safety valve button until the rotisserie burner stays lit.

Why isn't the rotisserie rotating? (some models only)

- Motor is off. Check that motor is switched on and plugged into a GFI outlet. Reset if tripped.
 - Rod not inserted correctly. Check the rod is inserted correctly in the motor and balanced on the rollers at the side of grill. See 'Using the rotisserie'.
 - Something is blocking it. Check that secondary cooking rack is not preventing rotisserie from turning. Check food is tied correctly and is centered and balanced on the rod. If not, switch motor off and turn burner to **LOW** while you readjust the food.
-

Why isn't the rotisserie light working? (some models only)

- Bulb has blown. Replace bulb. See 'Replacing light and battery.'
-

CUSTOMER CARE

Before you call for service or assistance

Check the things you can do yourself. Refer to the installation instructions and your user guide and check that:

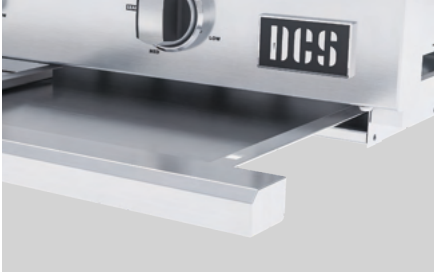

- ① Your product is correctly installed.
- ② You are familiar with its normal operation.
- ③ Model number (can be found on the inside, right side panel behind the drip tray handle).
- ④ Serial number (can be found on the inside, right side panel behind the drip tray handle).
- ⑤ Code (can be found on the inside, right side panel behind the drip pan handle).
- ⑥ Date of installation.

If you still need assistance or parts, please refer to the Service & Warranty book for warranty details and your nearest Authorized Service Center, Customer Care, or contact us through our website www.dcsappliances.com or email: customer.care@fisherpaykel.com.

Complete and keep for safe reference:

Model _____

Serial No. _____

Purchase Date _____

Purchaser _____

Dealer _____

City _____

State _____

Zip _____

Country _____

DCSAPPLIANCES.COM

© Fisher & Paykel Appliances 2026. All rights reserved.
Fisher & Paykel Appliances, 695 Town Center Drive
Suite 180, Costa Mesa, CA 92626, USA

The models shown in this guide may not be available in all markets
and are subject to change at any time.

The product specifications in this guide apply to the specific products and
models described at the date of issue. Under our policy of continuous product
improvement, these specifications may change at any time.

For current details about model and specification availability in your country,
please go to our website or contact your local DCS dealer.

431824D 02.26