

Microwave Oven

User manual

ME90H1780RAA

- For detailed instructions on installation and cleaning of the appliances, visit the Samsung website (<http://www.samsung.com>), go to Support > Support home, and then enter the model name.
- To check the product's model name, see the label enclosed with the product or attached to the product.
- Open a QR code scanner app and scan the QR code image attached to the product. You can access 'Product registration', 'Manual', and 'Customer support'.
- Figures and illustrations are provided for reference only and may differ from the actual product appearance. Product design and specifications may change without notice.

Contents

Safety Information	4
Important Safety Information	4
Important safety symbols	4
What You Need To Know About Safety Instructions	4
Precautions To Avoid Possible Exposure To Excessive Microwave Energy	4
Important Safety Symbols And Precautions	6
Grounding Instructions	7
Use Of Extension Cords	8
Critical Installation Warnings	8
Installation Cautions	9
Critical Usage Warnings	9
Usage Cautions	11
Critical Cleaning Instructions	12
State Of California Proposition 65 Warning	13
At a Glance	14
Setting up your new microwave oven	14
Checking the parts	14
Setting up your microwave oven	15
Checking the control panel	16
Clock Settings	17
Child Lock	17
Eco mode	17
Smart Control	18
Voice Control	19
Auto Connectivity	22
My settings	22
Smart Features	24
Operations	24
Kitchen Timer	24
Vent Fan (High/Mid/Low/Off)	24
Cooktop Lamp (High/Low/Off)	25
Turntable	25
Stop/Eco button	25
+30sec button	25
Accessory Combination Guide	26
Popcorn	27
Defrost	28
Air Fry Max Manual/Auto	30
Example for Air Fry Max Auto operation	32
Sensor Reheat/Cook	34
Sensor Reheat/Cook Cooking Guide	34
Auto Cook	36
Example for Auto Cook operation	37

Steam Cook	43
Pure steam cooking guide	43
Example for Steam Cook operation	45
Microwave	47
Convection Bake/Roast	48
Speed Bake/Roast	49
Cookware for cooking with speed bake/roast	49
Food suitable for speed bake/roast	50
Speed Bake/Roast Cooking Guide	50
Grill	52
Keep Warm	52
Steam Clean	53
Cookware guide	54
Recommended cooking utensils	54
Limited use items	54
Not recommended	54
Testing utensils	54
Cooking guide	55
Cooking techniques	55
Recommended cooking utensils	56
Guide for cooking eggs in your microwave	56
Guide for cooking vegetables in your microwave	56
Cleaning and Maintenance	57
Cleaning and maintaining your microwave oven	57
Cleaning the exterior	57
Cleaning under your microwave oven	57
Cleaning the control panel	57
Cleaning the door and door seals	57
Cleaning the interior	57
Cleaning the turntable and roller rings	58
Storing and repairing your microwave oven	58
Replacing the cooktop/night light	58
Replacing the oven light	59
Cleaning the grease filter	59
Replacing the charcoal filter	60
Troubleshooting	61
Information codes	66
Appendix	67
Appendix	67
Specifications	67
Warranty	68
Samsung MICROWAVE OVEN	68

IMPORTANT SAFETY INFORMATION

- Congratulations on your new Samsung appliances. This manual contains important information on the installation, use, and care of your appliances. Read this manual thoroughly before using the appliances to ensure that you know how to safely and efficiently operate the features and functions that your new appliances offers.

Important safety symbols

What the icons and signs in this user manual mean:

WARNING

Hazards or unsafe practices that may result in **severe personal injury, death and/or property damage.**

CAUTION

Hazards or unsafe practices that may result in **minor personal injury and/or property damage.**

Read the instructions

After reading this manual, store it in a safe place for future reference.

Read all instructions before using the appliance.

NOTE

Supplementary information that may be useful.

Congratulations on your new Samsung microwave oven. This manual contains important information on the installation, use and care of your appliance. Please take time to read this manual to take full advantage of your microwave oven's many benefits and features.

WHAT YOU NEED TO KNOW ABOUT SAFETY INSTRUCTIONS

Warnings and Important Safety Instructions in this manual do not cover all possible conditions and situations that may occur. It is your responsibility to use common sense, caution, and care when installing, maintaining, and operating your microwave oven.

PRECAUTIONS TO AVOID POSSIBLE EXPOSURE TO EXCESSIVE MICROWAVE ENERGY

- A. Do not attempt to operate this oven with the door open since open-door operation can result in harmful exposure to microwave energy. It is important not to defeat or tamper with the safety interlocks.
- B. Do not place any object between the oven front face and the door or allow soil or cleaner residue to accumulate on the sealing surface.

-
- C. Do not operate the oven if it is damaged. It is particularly important that the oven door close properly and that there is no damage to the:
 - 1. Door (bent),
 - 2. Hinges and latches, (broken or loosened),
 - 3. Door seals and sealing surface.
 - D. Only properly qualified service personnel should adjust or repair the oven. Do not attempt to adjust or repair the oven yourself.

When using any electrical appliance, basic safety precautions should be followed, including the following:

WARNING

To reduce risk of burns, electric shock, fire, personal injury or exposure to excessive microwave energy:

- 1. Read all safety instructions before using the appliance.
- 2. Read and follow the specific "Precautions to avoid possible exposure to excessive microwave energy" on page 4.
- 3. This appliance must be grounded. Connect only to properly grounded outlets. See Important "Grounding instructions" on page 8 of this manual.
- 4. Install or locate this appliance only in accordance with the provided installation instructions.
- 5. Some products such as whole eggs and sealed containers (for example, closed glass jars) can explode if heated rapidly. Never heat them in a microwave oven.
- 6. Do not use this appliance for other purposes than cooking. Drying of clothing and heating of warming pads, slippers, sponges, damp cloth and similar may lead to risk of injury, ignition or fire. Use this appliance only for its intended use as described in the manual. Do not put corrosive chemicals or vapors in or on this appliance. This type of oven is specifically designed to heat, cook, or dry food. It is not designed for industrial or laboratory use.
- 7. **HOT CONTENTS CAN CAUSE SEVERE BURNS. DO NOT ALLOW CHILDREN TO USE THE MICROWAVE.**
- 8. Do not operate this appliance if it has a damaged cord or plug, if it is not working properly, or if it has been damaged or dropped.
- 9. This appliance should be repaired or serviced only by qualified service personnel. Contact the nearest authorized service facility for examination, repair, or adjustment.
- 10. Do not cover or block any openings on the appliance.
- 11. Do not tamper with or make any adjustments or repairs to the door.
- 12. Do not store this appliance outdoors. Do not use this product near water, for example, near a kitchen sink, in a wet basement, near a swimming pool, or similar locations.
- 13. Do not immerse the cord or plug in water.
- 14. Keep the cord away from heated surfaces. (including the back of the oven).
- 15. Do not let the cord hang over edge of table or counter.
- 16. When cleaning surfaces of the door and oven that come together when the door closes, use only mild, nonabrasive soaps, or detergents applied with a sponge or soft cloth. Unplug the plug before cleaning.
- 17. To reduce the risk of fire in the oven cavity:
 - a. Do not overcook food. Carefully watch appliance when paper, plastic, or other combustible materials are placed inside the oven to facilitate cooking.

IMPORTANT SAFETY INFORMATION

- b. Remove wire twist-ties from paper or plastic bags before placing the bags in the oven.
 - c. If materials inside the oven ignite, keep the oven door closed, turn the oven off, and disconnect the power cord, or shut off the power at the fuse or circuit breaker panel. If the door is opened, the fire may spread.
 - d. Do not use the cavity for storage purposes. Do not leave paper products, cooking utensils, or food in the cavity when not in use.
18. Liquids, such as water, milk, coffee, or tea can be overheated beyond the boiling point without appearing to be boiling. Visible bubbling or boiling when the container is removed from the microwave oven is not always present. **THIS COULD RESULT IN VERY HOT LIQUIDS SUDDENLY BOILING OVER WHEN THE CONTAINER IS DISTURBED OR A SPOON OR OTHER UTENSIL IS INSERTED INTO THE LIQUID.** To reduce the risk of injury:
- a. Do not overheat liquid.
 - b. Stir liquid both before and halfway through heating it.
 - c. Do not use straight-sided containers with narrow necks.
 - d. After heating, allow the container to stand in the microwave oven for a short time before removing the container.
 - e. Use extreme care when inserting a spoon or other utensil into the container.
19. Oversized foods or oversized metal utensils should not be inserted in microwave / toaster oven as they may create a fire of electric shock.
20. Do not clean with metal scouring pads. Piece can burn off the pad and touch electrical parts involving a risk of electric shock.
21. Do not use paper products when appliance is operated in toaster mode.
22. Do not store any materials, other than manufacturer's recommended accessories, in this oven when not in use.
23. Do not cover racks or any other part of the oven with metal foil . This will cause overheating of the oven.

IMPORTANT SAFETY SYMBOLS AND PRECAUTIONS

What the icons and signs in this user manual mean:

WARNING









Hazards or unsafe practices that may result in **severe personal injury or death**.

CAUTION

Hazards or unsafe practices that may result in **minor personal injury or property damage**.

NOTE

To reduce the risk of fire, explosion, electric shock, or personal injury when using your microwave oven, follow these basic safety precautions.

-
- | | |
|--|--|
|  Do NOT attempt. |  Unplug the power plug from the wall socket. |
|  Do NOT disassemble. |  Make sure the machine is grounded to prevent electric shock. |
|  Do NOT touch. |  Call the service center for help. |
|  Follow directions explicitly. |  Note |

These warning signs are here to prevent injury to you and others. Please follow them explicitly. After reading this section, keep it in a safe place for future reference.

CAUTION

1. Clean Ventilating Hoods Frequently - Grease should not be allowed to accumulate on the hood of the filter.
2. When flaming foods under the hood, turn the fan on.
3. Use care when cleaning the vent-hood filter. Corrosive cleaning agents, such as lye-based oven cleaner, may damage the filter.

GROUNDING INSTRUCTIONS

This appliance must be grounded. In the event of an electrical short circuit, grounding reduces the risk of electric shock by providing an escape wire for the electrical current. This appliance is equipped with a cord that includes a grounding wire and a grounding plug. The plug must be plugged into an outlet that is properly installed and grounded.

WARNING

Improper use of the grounding plug can result in a risk of electric shock.

- Plug into a grounded, 3 pronged outlet. Do not remove the third (grounding) prong. Do not use an adaptor or otherwise thwart the safety function of the grounding plug.
- Consult a qualified electrician or service person if you do not understand the grounding instructions or if you are not sure if the appliance is properly grounded.
- We do not recommend using an extension cord with this appliance. If the power-supply cord is too short, have a qualified electrician or serviceman install an outlet near the appliance. However, if it is necessary to use an extension cord, read and follow the "Use of Extension Cords" section on the next page.

IMPORTANT SAFETY INFORMATION

USE OF EXTENSION CORDS

A short power-supply cord is provided to reduce the risk of your becoming entangled in or tripping over a longer cord. Longer cord sets or extension cords are available and you can use them if you exercise care. If you use a long cord or extension cord:

1. The marked electrical rating of the cord set or extension cord should be at least as great as the electrical rating of the appliance.
2. The extension cord must be a grounding-type 3-wire cord and it must be plugged into a 3-slot outlet.
3. The longer cord should be arranged so that it will not drape over the counter top or tabletop where it can be pulled on by children or tripped over accidentally. If you use an extension cord, the interior light may flicker and the speed of the blower may vary when the microwave oven is on. Cooking times may be longer too.

CRITICAL INSTALLATION WARNINGS



This appliance must be installed by a qualified technician or service company.

- Failing to have a qualified technician install the oven may result in electric shock, fire, an explosion, problems with the product, or injury.

Unpack the oven, remove all packaging material and examine the oven for any damage such as dents on the interior or exterior of the oven, broken door latches, cracks in the door, or a door that is not lined up correctly. If there is any damage, do not operate the oven and notify your dealer immediately.

Make sure to install your oven in a location with adequate space.

Remove all foreign substances such as dust or water from the power plug terminals and contact points using a dry cloth on a regular basis.

- Unplug the power plug and clean it with a dry cloth.
- Failing to do so may result in electric shock or fire.

Plug the power cord into a properly grounded 3 pronged outlet. Your oven should be the only appliance connected to this circuit.

- Sharing a wall socket with other appliances, using a power strip, or extending the power cord may result in electric shock or fire.
- Do not use an electric transformer. It may result in electric shock or fire.
- Ensure that the voltage, frequency and current provided match the product's specifications. Failing to do so may result in electric shock or fire.

Keep all packaging materials out of the reach of children. Children may use them for play.



This appliance must be properly grounded. Read and follow the specific "Grounding instructions" found in the beginning of this section. Do not ground the appliance to a gas pipe, plastic water pipe, or telephone line.

- This may result in electric shock, fire, an explosion, or problems with the product.
- Never plug the power cord into a socket that is not grounded correctly and make sure that it is grounded in accordance with local and national codes.

Do not cut or remove the third (ground) prong from the power cord under any circumstances.

The microwave requires a separate branch circuit single grounded outlet of at least 15A and max of 20A.

 Do not install this appliance in a humid, oily, or dusty location, or in a location exposed to direct sunlight or water (rain drops).

- This may result in electric shock or fire.

Plug the power plug into the wall socket firmly. Do not use a damaged power plug, damaged power cord, or loose wall socket.

- This may result in electric shock or fire.

Do not mount over a sink.

Do not pull or excessively bend the power cord.

Do not twist or tie the power cord.

Do not hook the power cord over a metal object, place a heavy object on the power cord, insert the power cord between objects, or push the power cord into the space behind the appliance.

- This may result in electric shock or fire.

Do not pull the power cord when you unplug the oven.

- Unplug the oven by pulling the plug only.
- Failing to unplug may result in electric shock or fire.

 When the power plug or power cord is damaged, contact your nearest service center for a replacement or repair.

INSTALLATION CAUTIONS

 Position the oven so that the plug is easily accessible.

- Failing to do so may result in electric shock or fire due to electric leakage.

 Unplug the oven when it is not being used for long periods of time or during a thunder/lightning storm.

- Failing to do so may result in electric shock or fire.

CRITICAL USAGE WARNINGS

 If the microwave appliance is flooded, please contact your nearest service center. Failing to do so may result in electric shock or fire.

Read and follow the specific "Precautions to Avoid Possible Exposure to Excessive Microwave Energy", found in the beginning of this Safety Information Section.

If the microwave generates a strange noise, a burning smell or smoke, unplug it immediately and contact your nearest service center.

- Failing to do so may result in electric shock or fire.

In the event of a gas leak (propane gas, LP gas, etc.), ventilate the room immediately. Do not touch the microwave, power cord, or plug.

- Do not use a ventilating fan.
- A spark may result in an explosion or fire.

IMPORTANT SAFETY INFORMATION

Take care that the door or any of the other parts do not come into contact with your body while cooking or just after cooking.

- Failing to do so may result in burns.

In the event of a grease fire on the surface units below the oven, smother the flaming pan on the surface unit by covering the pan completely with a lid, a cookie sheet, or a flat tray.

Never leave surface units beneath your oven unattended at high heat settings. Boil overs cause smoking and greasy spillovers that may ignite and spread if the vent fan is operating. To minimize automatic fan operation, use adequate sized cookware and use high heat on surface units only when necessary.

If materials inside the oven should ignite, keep the oven door closed, turn the oven off and disconnect the power cord, or shut off power at the fuse or circuit breaker panel. If the door is opened, the fire may spread.

Use of inadequately sized cookware on top of the stove may result in melting of microwave door or other damage.

- Always observe safety precautions when using your oven. Never try to repair the oven on your own. There is dangerous voltage inside. If the oven needs to be repaired, contact an authorized service center near you.



Do not attempt to repair, disassemble, or modify the appliance yourself.

- Because a high voltage current enters the product chassis during operation, opening the chassis can result in electric shock or fire.
- You may be exposed to electromagnetic waves.
- When the oven requires repair, contact your nearest service center.



If any foreign substance such as water enters the microwave, unplug it, and then contact your nearest service center.

- Failing to do so may result in electric shock or fire.



Do not touch the power plug with wet hands.

- This may result in electric shock.

Do not turn the appliance off by unplugging the power plug while the appliance is in operation.

- Plugging the power plug into the wall socket again may cause a spark and result in electric shock or fire.

Keep all packaging materials well out of the reach of children. Packaging materials can be dangerous to children.

- If a child places a bag over its head, the child can suffocate.

Do not let children or any person with reduced physical, sensory or mental capabilities use this appliance unsupervised. Make sure that the appliance is out of the reach of children.

- Failing to do so may result in electric shock, burns, or injury.

Do not touch the inside of the appliance immediately after cooking. The inside of the appliance will be hot.

- The heat on the inside of the oven can cause burns.

Do not put aluminum foil (except as specifically directed in this manual), metal objects (such as containers, forks, etc.), or containers with golden or silver rims into the microwave.

- These objects can cause sparks or a fire.

Do not use or place flammable sprays or objects near the oven.

- Heat from the microwave can cause flammable sprays to explode or burn.
- Failing to do so may result in electric shock or injury.

Do not tamper with or make any adjustments or repairs to the door. Under no circumstances should you remove the outer cabinet.

Do not store or use the oven outdoors.

USAGE CAUTIONS



If the surface of the microwave is cracked, turn it off.

- Failing to do so may result in electric shock.

Dishes and containers can become hot. Handle with care.

Hot foods and steam can cause burns. Carefully remove container coverings, directing steam away from your hands and face.

Remove lids from baby food before heating. After heating baby food, stir well to distribute the heat evenly. Always test the temperature by tasting before feeding the baby. The glass jar or surface of the food may appear to be cooler than the food in the interior, which can be so hot that it will burn the infant's mouth.

Make sure all cookware used in the oven is suitable for microwaving.

Use microwavable cookware in strict compliance with such manufacturer's recommendations.



Do not stand on top of the microwave or place objects (such as laundry, oven covers, lighted candles, lighted cigarettes, dishes, chemicals, metal objects, etc.) on the appliance.

- Items, such as a cloth, may get caught in the door.
- This may result in electric shock, fire, problems with the product, or injury.

Do not operate the appliance with wet hands.

- This may result in electric shock.

Do not spray volatile material such as insecticide onto the surface of the appliance.

- As well as being harmful to humans, it may also result in electric shock, fire or problems with the product.

Do not place the appliance over a fragile object such as a sink or glass object.

- This may result in damage to the sink or glass object.

Do not put your face or body close to the appliance while cooking or when opening the door just after cooking.

- Take care that children do not come too close to the appliance.
- Failing to do so may result in children burning themselves.

Do not place food or heavy objects over the door when opening the door.

- The food or object may fall and this may result in burns or injury.

Do not abruptly cool the door, the inside of the appliance, or the dish by pouring water over it during or just after cooking.

- This may result in damage to the appliance. The steam or water spray may result in burns or injury.

IMPORTANT SAFETY INFORMATION

Do not cook without the glass tray in place on the oven floor. Food will not cook properly without the tray.

Do not defrost frozen beverages in narrow-necked bottles. The containers can break.

Do not scratch the glass of the oven door with a sharp object.

- This may result in the glass being damaged or broken.

Do not store anything directly on top of the appliance when it is in operation.

Do not use sealed containers. Remove seals and lids before use. Sealed containers can explode due to buildup of pressure even after the oven has been turned off.

CRITICAL CLEANING INSTRUCTIONS

Do not clean the appliance by spraying water directly onto it.

Do not use benzene, thinner, or alcohol to clean the appliance.

- This may result in discoloration, deformation, damage, electric shock, or fire.

Before cleaning or performing maintenance, unplug the appliance from the wall socket and remove food waste from the door and cooking compartment.

- Failing to do so may result in electric shock or fire.

Take care not to hurt yourself when cleaning the appliance.

(external/internal)

- You may hurt yourself on the sharp edges of the appliance.

Do not clean the appliance with a steam cleaner.

- This may result in corrosion.

Keep the inside of the oven clean. Food particles or spattered oils stuck to the oven walls or floor can cause paint damage and reduce the efficiency of the oven.

1. FCC NOTICE

FCC STATEMENT :

This equipment generates and uses ISM frequency energy and if not installed and used properly, that is in strict accordance with the manufacturer's instructions, may cause interference to radio and television reception. It has been type tested and found to comply with limits for ISM Equipment pursuant to part 18 of FCC Rules, which are designed to part 18 of FCC Rules, which are designed to provide residential installation.

However, there is no guarantee that interference will not occur in a particular installation. If this equipment does cause interference to radio or television reception, which can be determined by turning the equipment off and on, the user is encouraged to try to correct the interference by one or more of the following:

- Reorient the receiving antenna of the radio or television.
- Relocate the Microwave Oven with respect to the receiver.
- Move the microwave oven away from the receiver.
- Plug the microwave oven into a different outlet so that the microwave oven and the receiver are on different branch codes.

The manufacturer is not responsible for any radio or TV interference caused by unauthorized modification to this microwave oven. It is the responsibility of the user to correct such interference.

This equipment has been tested and found to comply with the limits for a Class B digital device, pursuant to part 15 of the FCC Rules. These limits are designed to provide reasonable protection against harmful interference in a residential installation. This equipment generates, uses and can radiate radio frequency energy and, if not installed and used in accordance with the instructions, may cause harmful interference to radio communications. However, there is no guarantee that interference will not occur in a particular installation. If this equipment does cause harmful interference to radio or television reception, which can be determined by turning the equipment off and on, the user is encouraged to try to correct the interference by one or more of the following measures:

- Reorient or relocate the receiving antenna.
- Increase the separation between the equipment and receiver.
- Connect the equipment into an outlet on a circuit different from that to which the receiver is connected.
- Consult the dealer or an experienced radio/TV technician for help.

WARNING

Any changes or modifications to this unit not expressly approved by the party responsible for compliance could void the user's authority to operate the equipment.

FCC RF Exposure Requirements

This device complies with FCC RF radiation exposure limits set forth for an uncontrolled environment. The antenna(s) used for this transmitter must not be co-located or operating in conjunction with any other antenna or transmitter and must be installed to provide a separation distance of at least 20cm from all persons.

2. IC Notice

This device contains licence-exempt transmitter(s)/receiver(s) that comply with Innovation, Science and Economic Development Canada's licence-exempt RSS(s). Operation is subject to the following two conditions:

- 1) This device may not cause interference.
- 2) This device must accept any interference, including interference that may cause undesired operation of the device.
 - CAN ICES(B)/NMB(B)

IC RADIATION EXPOSURE STATEMENT:

This equipment complies with IC RSS-102 radiation exposure limits set forth for an uncontrolled environment. This equipment should be installed and operated so there is at least 8 inches (20 cm) between the radiator and your body. This device and its antenna(s) must not be co-located or operated in conjunction with any other antenna or transmitter.

STATE OF CALIFORNIA PROPOSITION 65 WARNING

WARNING : This product contains chemicals known to the State of California to cause cancer and birth defects or other reproductive harm.

Setting up your new microwave oven

Be sure to follow these instructions closely so that your new microwave oven works properly.

Checking the parts

Carefully unpack your microwave oven, and make sure you've received all the parts shown below. If your microwave oven was damaged during shipping, or if you do not have all the parts, contact the Samsung Call Center. (Refer to the "Warranty" on page 68.)

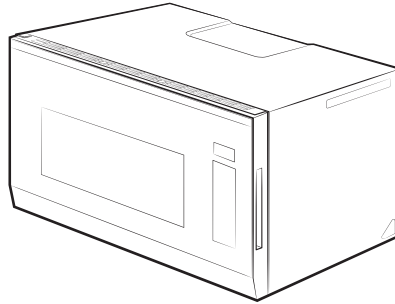

Microwave oven



* Ceramic Enamel Tray



* Glass Tray



* Roller Guide Ring



* Grease Filters (2 ea)

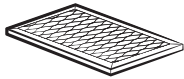

* Charcoal Filter

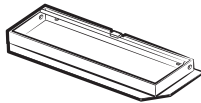

* Exhaust Adaptor



* Hardware Kit
(Screws & Brackets)

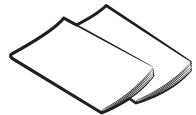

Manuals
(User & Installation)



Cooking Guide Manual

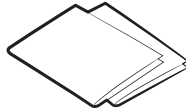

Templates
(Top & Wall)



* Low Rack



* High Rack



* Pure Steam Bowl

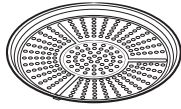

* Air Fry Max Tray
(Sold Separately)

NOTE

If you need an accessory marked with an * (asterisk), please contact the Samsung Call Center using the phone number listed on the last page of this manual or visit our on-line parts web site at www.samsungparts.com.

Setting up your microwave oven

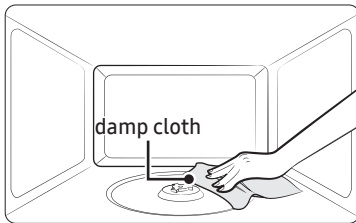

1. Open the door by pulling the handle on the right side of the door.
2. Wipe the inside of the oven with a damp cloth.

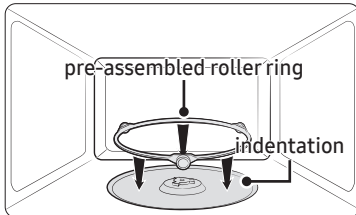

3. Install the pre-assembled ring into the indentation at the center of the microwave oven.

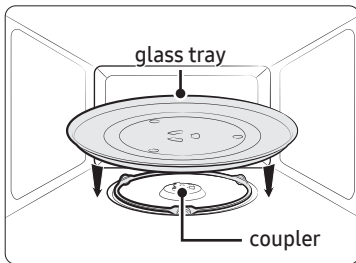

4. Fit the center of the glass tray to the coupler.

Setting up your new microwave oven

Checking the control panel

At a Glance

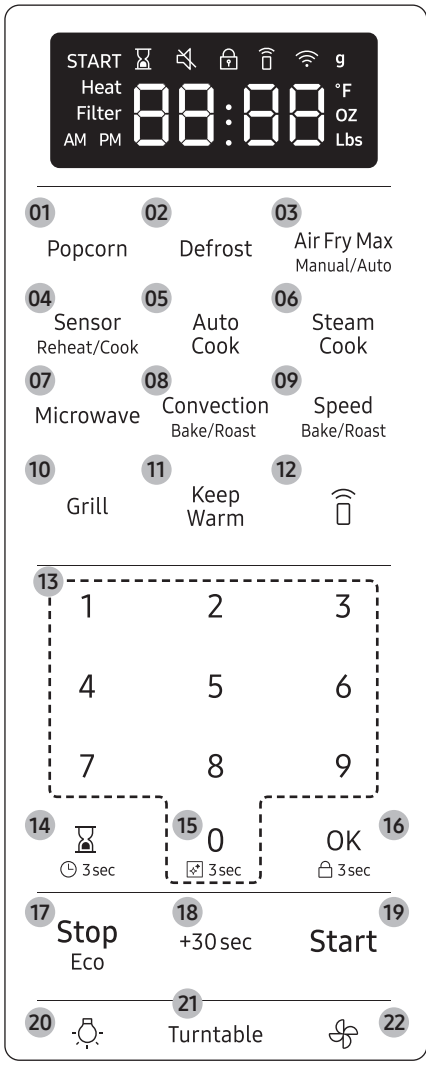



- 01 Popcorn
- 02 Defrost
- 03 Air Fry Max Manual/Auto
- 04 Sensor Reheat/Cook
- 05 Auto Cook
- 06 Steam Cook
- 07 Microwave
- 08 Convection Bake/Roast
- 09 Speed Bake/Roast
- 10 Grill
- 11 Keep Warm
- 12 Smart Control
- 13 Number Pad
- 14 Kitchen Timer/Clock Setting
- 15 Steam Clean
- 16 OK/Child Lock
- 17 Stop/Eco
- 18 +30sec
- 19 Start
- 20 Light (Hi/Low/Off)
- 21 Turntable
- 22 Vent (3 Speed & On/Off)

Clock Settings

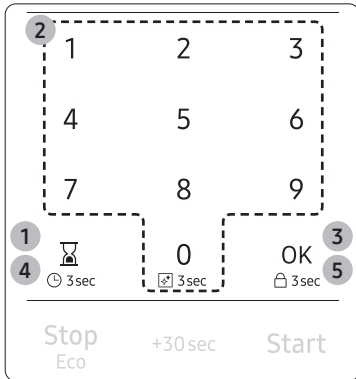
Your microwave oven is equipped with a built-in clock. Set the clock when first installing your microwave oven or after a power failure. The time is displayed whenever the microwave oven is not being used.



1. Touch the  button for 3 seconds.
2. Use the number pad to enter the time.
3. Touch the **OK** button.
4. Touch the  button to change AM to PM. (Only for 12hr mode.)

NOTE

To change the clock display settings (12hr or 24hr mode), refer to **My Settings** on page 22.

5. Touch the **OK** button.

Child Lock

The **Child Lock** function allows you to lock all buttons so that the microwave oven cannot be operated by children accidentally. The oven can be locked at any time.

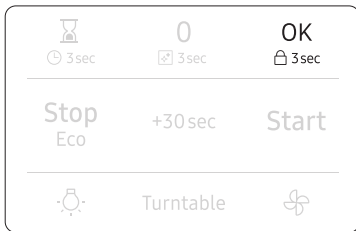

Activating / Deactivating

If you want to activate or deactivate the child lock function, touch the  button for 3 seconds.

The display will show '

Eco mode

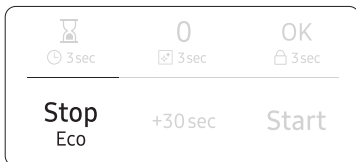

Eco Mode reduces standby power usage. When you touch the **Stop/Eco** button once, the display will go out and the microwave shifts to a mode which minimizes power usage. To cancel the Eco Mode, touch any other button.

Setting up your new microwave oven

Smart Control

To use the microwave oven's Smart Control, you must download the SmartThings app to a mobile device. Functions operated by the SmartThings app may not work smoothly if communication conditions are poor or the microwave oven is installed in a place with a weak Wi-Fi signal.

How to connect the microwave oven

1. Download and open the SmartThings app on your smart device.
2. Follow the app's on-screen instructions to connect your microwave oven.
3. Once the process is complete, the  icon appears on your microwave oven display and the app will confirm you are connected.
4. If the connection icon does not turn on, follow the instruction on the app to reconnect.



To Start the microwave oven remotely

For safety reasons, This function is only available for convection and grill mode but not in microwave mode start.

1. After following the above steps, touch **Smart Control** to use the microwave oven remotely.
2. If  appears on the display, microwave oven can be started and controlled remotely by a connected mobile device.
3. Select the microwave oven icon on the SmartThings app and if the app is connected to the microwave oven, you can perform the following functions through the application:

Microwave Oven remote control using the SmartThings app	
Microwave Oven Monitoring	<ul style="list-style-type: none">• Check the status of the microwave oven
Microwave Oven Remote Control	<ul style="list-style-type: none">• Control remotely in convection and grill mode but not in microwave mode start• Remotely control vent fan speed/cooktop lamp

NOTE

- After enabling Smart Control, if you open the door before cooking starts, Smart Control will be disabled.
- Even if  does not show on the display, you can still monitor the microwave oven's status and turn the microwave oven off.
- When oven cooking is finished or cancelled,  will turn off.
- For safety reasons, you cannot turn on the microwave oven remotely and you must specify the cooking time to enable remote control.
- Smart Control will not work properly if the Wi-Fi Connection is unstable.

Voice Control

To use the microwave oven's Voice Control function, you need Bixby / Amazon Alexa App / Google Assistant App on your mobile device.

- **Bixby** : Start conversation with Bixby on Samsung mobile by saying "Hi Bixby" or by pressing the side key.

Function	OTR Bixby Command	Remarks
Start	<ul style="list-style-type: none"> • Start the microwave in air fry max mode at 350 degrees for 30 minutes. • Start the microwave in convection bake mode at 350 degrees for 30 minutes • Start the microwave in convection roast mode at 350 degrees for 30 minutes • Start the microwave in keep warm mode for 30 minutes • Start the microwave in grill mode for 30 minutes • Set Air fry max mode in the microwave at 350 degrees • Convection bake in the microwave at 350 degrees • Convection roast in the microwave at 350 degrees • Keep warm in the microwave • Grill in the microwave 	<ul style="list-style-type: none"> • Air Fry Max 350°F(177°C), 375°F(191°C), 400°F(204°C), 425°F(218°C) • Convection Bake 100°F(38°C), 200°F(93°C), 225°F(107°C), 250°F(121°C), 275°F(135°C), 300°F(149°C), 325°F(163°C), 350°F(177°C), 375°F(191°C), 400°F(204°C), 425°F(218°C) • Convection Roast 200°F(93°C), 225°F(107°C), 250°F(121°C), 275°F(135°C), 300°F(149°C), 325°F(163°C), 350°F(177°C), 375°F(191°C), 400°F(204°C), 425°F(218°C)
Turn Off/Stop	<ul style="list-style-type: none"> • Cancel the microwave • Turn off the microwave 	-
Check Temp	<ul style="list-style-type: none"> • What is the temperature of the microwave • Check the microwave temperature 	-
Check Time	<ul style="list-style-type: none"> • Check the remaining time of the microwave • How much time is left on the microwave timer? 	-
Check Status	<ul style="list-style-type: none"> • Check the microwave status • Check the status of the microwave 	-
Temp Control	<ul style="list-style-type: none"> • Set the temperature of the microwave to 300 • Increase the temp of the microwave by 20 • Decrease the temp of the microwave by 20 • Turn the microwave temperature up to 100 degrees • Turn the microwave temperature down to 50 degrees 	-
MW Hood Control	<ul style="list-style-type: none"> • Turn on/off the microwave hood light • Trun on/off hood power of microwave • Turn on/off hood fan of microwave • Set the microwave hood fan speed to high/mid/low 	-
Oven Timer (Change Cook Time)	<ul style="list-style-type: none"> • Set the timer on the microwave to 1 hour 	-

Setting up your new microwave oven

- **Amazon Alexa & Google Assistant** : Samsung smart home appliances are supported by SmartThings skill in Alexa & action in Google Assistant.

Installation Guide

Here's how to link SmartThings account into Amazon Alexa or Google Assistant. SmartThings App and Alexa App(or Google Assistant App) Should be installed on your phone.

1. Setup the supported devices to SmartThings.
2. After device setup, tap + button on the screen.
3. Tap 'Voice assistant' and link your Samsung account to Amazon Alexa. (or Google Assistant)
4. Check the devices are visible on Amazon Alexa app. Then account linking is complete. (Check the devices are visible and set the location(home&room) of devices in Google home app. Then account linking is complete.)

Function	"Alexa"	"Ok Google"
Start	<ul style="list-style-type: none"> • Set the microwave to Microwave • Set the microwave to Grill • Set the microwave to Convection bake • Set the microwave to Convection roast • Set the microwave to Keep warm 	<ul style="list-style-type: none"> • Set the microwave to Microwave • Set the microwave to Convection bake • Set the microwave to Convection roast • Set the microwave to Keep warm
	<ul style="list-style-type: none"> • Set the microwave to Convection bake for 1 hour [Time] at 350 degrees [Temp] • Set the microwave to Convection roast for 1 hour [Time] at 350 degrees [Temp] • Convection bake for 1hour [Time] at 350degrees [Temp] • Convection roast for 1hour [Time] at 350degrees [Temp] 	
	<ul style="list-style-type: none"> • Set the microwave to Convection bake at 350 degrees [Temp] • Set the microwave to Convection roast at 350 degrees [Temp] • Convection bake at 350 degrees [Temp] • Convection roast at 350 degrees [Temp] 	
	<ul style="list-style-type: none"> • Set the microwave to Microwave for 90 seconds [time] • Set the microwave to Grill for 30 minutes [time] • Set the microwave to Convection bake for 1 hour [time] • Set the microwave to Convection roast for 1 hour [time] • Set the microwave to Keep warm for 1 hour [time] 	

- If the Smart Control is "ON", it will start remotely.
- If the Smart Control is "OFF", only the setting value can be delivered.
(Microwave mode can only delivered setting value)

Function	"Alexa"	"Ok Google"
Turn Off/Stop	<ul style="list-style-type: none"> • Turn off the microwave • Stop the microwave 	<ul style="list-style-type: none"> • Turn off the microwave • Stop the microwave
Pause	<ul style="list-style-type: none"> • Pause the microwave 	<ul style="list-style-type: none"> • Pause the microwave
Resume	<ul style="list-style-type: none"> • Resume the microwave 	<ul style="list-style-type: none"> • Resume the microwave • Restart the microwave
Check Temp	<ul style="list-style-type: none"> • What is the temperature of the microwave? 	<ul style="list-style-type: none"> • What is the temperature of the microwave?
Check Time	-	<ul style="list-style-type: none"> • What time is left on the microwave?
Check Status	<ul style="list-style-type: none"> • Is the microwave running? • Is the microwave on? 	<ul style="list-style-type: none"> • Is the microwave running? • Is the microwave on?
Set Timer	<ul style="list-style-type: none"> • [2 minutes] on the microwave e.g. <ul style="list-style-type: none"> - 90 seconds on the microwave (*While running) : Changing cook time (*Ready) : Set requested time with microwave mode as default 	<ul style="list-style-type: none"> • Set the microwave to [5 minutes] e.g. <ul style="list-style-type: none"> - Set the microwave to 2 minutes (*While running) : Changing cook time (*Ready) : Set requested time with microwave mode as default
Adjust timer	<ul style="list-style-type: none"> • Add [10 minutes] to the microwave • [30] more [seconds] to the microwave e.g. <ul style="list-style-type: none"> - 2 more minutes to the microwave (*While running) : Adding cook time (*Ready) : Set requested time with microwave mode as default 	<ul style="list-style-type: none"> • Add [30 seconds] to the microwave e.g. <ul style="list-style-type: none"> - Add 30 seconds to the microwave (*While running) : Adding cook time (*Ready) : Set requested time with microwave mode as default
Set temperature	<ul style="list-style-type: none"> • Set microwave to [200 (degrees, Celsius, Fahrenheit)] • Set [device name] to [200 (degrees, Celsius, Fahrenheit)] 	<ul style="list-style-type: none"> • Set the microwave to [200 degrees, Fahrenheit, Celsius]
MW Hood Control	<ul style="list-style-type: none"> • Turn on/off the (hood light, hood lamp, lamp, light) on microwave • Turn on/off the (hood light, hood lamp) • Set the microwave (brightness, light level, lamp level) to [low, high] • Turn on/off the (hood, fan, hood fan) on microwave[device name] • Turn on/off the (hood, hood fan) • Set the microwave (hood, fan, hood fan) speed to [low, medium, high] 	<ul style="list-style-type: none"> • Turn on/off the microwave (light, lamp) • Turn on/off the (hood light, hood lamp) • Set the microwave (brightness, light level, lamp level) to [low, high] • Turn on/off the (hood, fan, hood fan) on microwave • Turn on/off the (hood, hood fan) • Set the microwave (hood, fan, hood fan) speed to [low, medium, high]

Setting up your new microwave oven

NOTE

- **Bixby** : Only remote start function is possible. It's impossible to deliver only setting value. (Unable to control microwave mode)
- **Amazon Alexa & Google Assistant** : For safety reasons, you cannot turn on the microwave oven remotely, only setting value can be delivered.
- If the time or temperature information is not mentioned, it will operate with default time and temperature setting.
- Smart Control On/Off spec is same as SmartThings app note.

Auto Connectivity

Auto Connectivity function lets you quickly connect the hood via Wi-Fi with a compatible Samsung cooktop after the hood and cooktop have been paired. To turn the function on, press the Auto Connectivity button in SmartThings App. To disconnect the hood and cooktop, press the Auto Connectivity button again. While the hood and cooktop are connected, the hood fan will automatically turn on when you turn on the cooktop. The hood fan will also turn off automatically when you turn off the cooktop.

NOTE

Auto connectivity function may not work normally when the temperature is set high.

My settings

You can customize your new microwave oven to suit your preferences.

To customize:

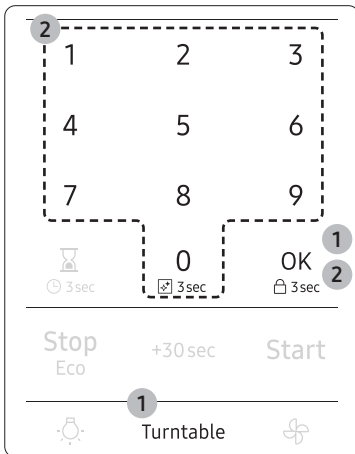

1. Touch the **Turntable** button for 3 seconds.
Touch the **number pad** to select a function you want to customize (Refer to the table below.) and then touch **OK** button.
2. Touch number 1 or 2 to change the options and then touch **OK**. (Number of the options are listed on the table below.)

Corresponding number for functions and options are listed in the table below.

No.	Function	Description	Options	
1	Weight Display	Pounds and grams are able for Weight Display options.	1	lbs
			2	g
2	Clock Display	The clock can display in either the 12 HR or 24 HR time mode.	1	12 Hr
			2	24 Hr
3	Sound	Sound can be turned On and Off.	1	ON
			2	OFF
4	Remind End Signal	The Remind End Signal can be turned On and Off.	1	ON
			2	OFF
5	Filter Remind	The Filter Remind function can be turned On and Off.	1	ON
			2	OFF
6	Wi-Fi	The Wi-Fi function can be turned On and Off.	1	ON
			2	OFF

NOTE

- If you change your mind while adjusting a setting, touch the **Stop/Eco** button to cancel, and then adjust the setting again.
- If there is a power interruption, you will need to reset 'Filter Remind' options.

Filter Reminder

If the **Filter Remind** function is **ON**, the microwave will remind you to clean or replace the grease filter every four months. When it is time to clean or replace the grease filter, the microwave displays the "Filter" message to remind you to clean or replace the grease filter. To remove the message, touch the number 0 when the microwave is in standby mode. If you don't want to receive this message, set the **Filter Remind** function off in **My settings**.

Operations

Kitchen Timer

Your microwave has a built-in timer function - the Kitchen Timer. Use the Kitchen Timer for timing up to 99 minutes, 99 seconds.

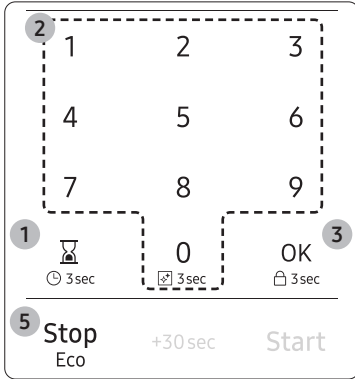



1. Touch the  button.
2. Use the **number pad** to set the time you want the timer to run. (Max time 99 minutes, 99 seconds.)
3. Touch the **OK** button.
4. The display counts down and beeps when the time has elapsed.
5. To cancel the timer setting : Touch the **Stop/Eco** button once.

Vent Fan (High/Mid/Low/Off)

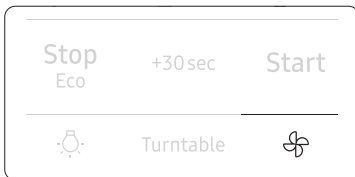
The vent fan removes steam and other vapors that result from cooking on the cooktop below.



Touch the  button once for high fan speed, twice for medium fan speed, and three times for low fan speed. Touch the  button four times to turn the fan off.

On the display 3, 2, 1, OFF will appear instead of High, Mid, Low, Off.

NOTE

- The exhaust fan's speed will decrease when the oven's cooking function is activated.
- The Vent Fan protects the microwave from excess heat rising from the cooktop below it. It automatically turns on if it senses too much heat. If you have turned the fan on, you may find that you cannot turn it off. The fan will automatically turn off when the internal parts are cool. It may stay on for 30 minutes or more after the cooktop and microwave controls are turned off.

Cooktop Lamp (High/Low/Off)

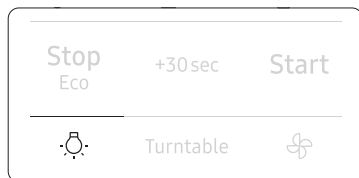

Touch the  button to turn the cooktop lamp on or off. Touch the button once for high, twice for low, and three times to turn the cooktop lamp off.

On the display Hi, Lo, OFF will appear instead of High, Low, Off.

Turntable

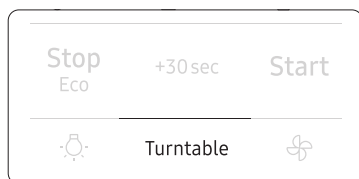

For best cooking results, leave the turntable on. However, for large dishes it can be turned off.

Touch the Turntable button to turn the turntable on or off.

CAUTION

The turntable may become too hot to touch.

Use pot holders to handle the turntable during and after cooking.

Stop/Eco button

The Stop/Eco button allows you to clear instructions you have entered.

It also allows you to pause the oven's cooking cycle, so that you can check the food.

- To pause the oven during cooking, touch the **Stop/Eco** button once. To restart, touch the **Start** button.
- To stop cooking, erase instructions, and return the oven display to the time of day, touch the **Stop/Eco** button twice.
- To clear instructions you have just entered, touch the **Stop/Eco** button once, and then re-enter the instructions.
- To cancel a kitchen timer setting, touch the **Stop/Eco** button once.

+30sec button

This feature offers a convenient way to increase cooking time. **+30sec** feature is only for manual cooking mode.



1. In standby mode, touching **+30sec** button will add 30 seconds of microwave mode at 100 % power. (Power level can not be changed in this way.)
2. If the oven is in manual cooking mode, touching **+30sec** button will add cooking time by 30 seconds.

Operations

Accessory Combination Guide

Smart Features

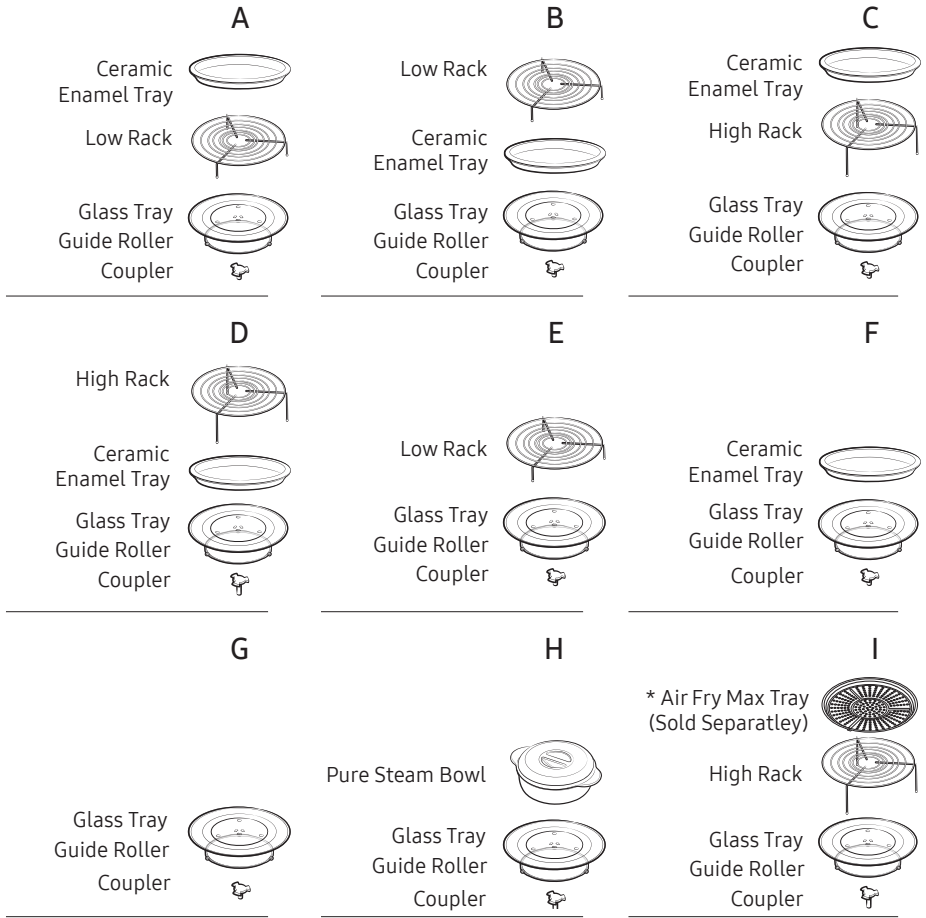

Popcorn

You can cook popcorn easily using the **Popcorn** button. You do not need to set either the cooking time or the power level.

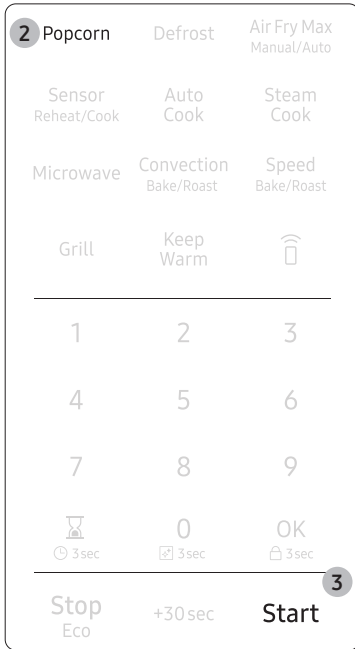

1. Put a bag of unpopped popcorn on the tray.
2. Touch the **Popcorn** button.
3. Touch the **Start** button.
Then the microwave oven will automatically be operated by sensing the popcorn inside. (2.0 - 3.5 oz.)

Operations

Defrost

Remove all packaging material before defrosting. Place meat, poultry, fish, bread, etc. on a turntable (glass tray).

General defrosting instructions:

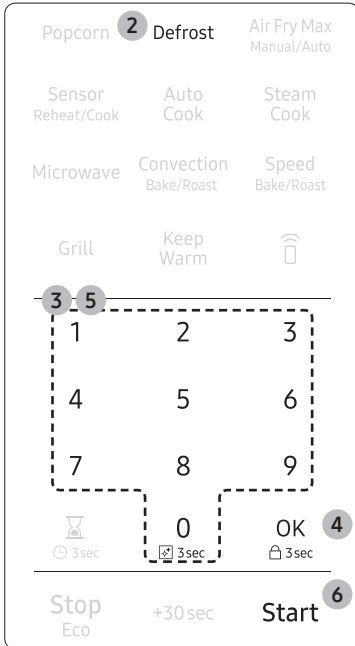

1. Place the food on the turntable.
2. Touch the **Defrost** button.
3. To select the number that corresponds to the food you want to defrost, touch the **number pad**. (Refer to the table on the next page.)
4. Touch the **OK** button.
5. Enter the weight of the food by touching the **number pad**. (Refer to the table on the next page to see the weights you can enter.)
6. Touch the **Start** button.
The microwave oven will automatically operate for the pre-programmed time.

For specific instructions for different kinds of food, see the table below.

Cook No.	Food	Amount	Directions
1	Meat	0.1 - 6.0 lb 100 - 2700 g	Shield the edges with aluminium foil. Flip the meat when the oven beeps. This program is suitable for lamb, pork, steaks, chops, and ground meat. For ground meat, place the meat directly on the turntable tray on wax paper. Do not use an extra tray. Let stand, covered with foil, for 5 - 10 minutes.
2	Poultry	0.1 - 6.0 lb 100 - 2700 g	Shield the leg and wing tips with aluminium foil. Flip the poultry when the oven beeps. This program is suitable for whole chicken as well as for chicken portions.
3	Fish	0.1 - 6.0 lb 100 - 2700 g	Shield the tail of a whole fish with aluminium foil. Flip the fish when the oven beeps. This program is suitable for whole fish as well as for fish fillets.
4	Bread	0.1 - 2.0 lb 100 - 900 g	Put bread on a paper towel or place cake on a ceramic plate and if possible, flip as soon as the oven beeps. (The oven keeps operating and stops only when you open the door.) This program is suitable for all kinds of bread, sliced or whole, as well as for bread rolls and baguettes. Arrange bread rolls in a circle.

 **NOTE**

Check food when the oven signals. After the final stage, small sections may still be icy. Let them stand to continue thawing. Food is not fully defrosted until all ice crystals have thawed. Shielding roasts and steaks with small pieces of foil prevents the edges from cooking before the center of the food has defrosted. Use narrow, flat, smooth strips of aluminum foil to cover the edges and thinner sections of the food.

Operations

Air Fry Max Manual/Auto

The Air Fry Max mode uses hot air for crispier and healthier frozen foods without oil.

The microwave mode is not used.

You can set the temperature as required, in a range varying from 350°F to 425°F.

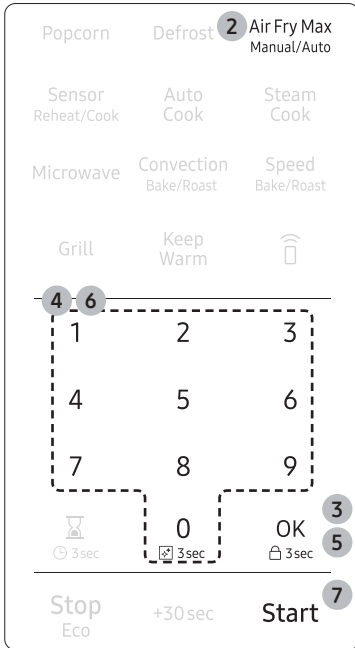

Manual Mode

1. Place the food on the tray or the rack. (See **Accessory Combination Guide** on page 26)
2. Touch the **Air Fry Max Manual/Auto** button once for Manual mode.
3. Touch the **OK** button.
4. To set the temperature, touch **number pad**. (350°F, 375°F, 400°F and 425°F are available.)
5. Touch the **OK** button.
6. Use the **number pad** to set a cooking time.
7. Touch the **Start** button to begin Air Fry Max cooking. If you want to add 30 seconds of cooking time, touch **+30sec** button. You can adjust the cooking time while the microwave oven is in operation.

NOTE

- To maintain a constant temperature, keep the oven door closed while the food is cooking. Open as infrequently as possible.
- While operation the oven, if you want to change the temperature setting, touch the **OK** button, touch the **number pad** and then touch the **OK** button.

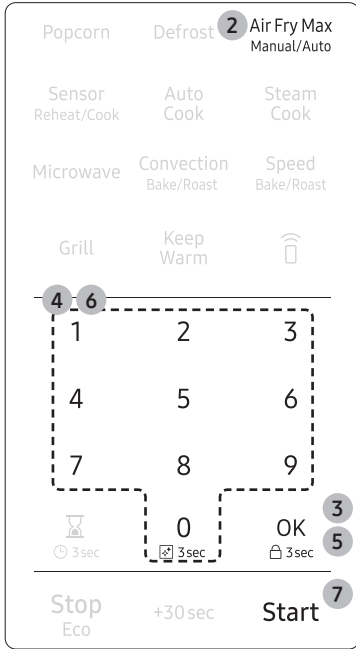

Auto Mode

1. Place the food on the tray or the rack. (See **Accessory Combination Guide** on page 26)
2. Touch the **Air Fry Max Manual/Auto** button twice for Auto mode.
3. Touch the **OK** button.
4. Use the **number pad** to select the number that corresponds to the food. (refer to the table on page 33.)
5. Touch the **OK** button.
6. Enter the amount of food by touching the **number pad** (1 or 2). (Refer to the table on page 33.)
7. Touch the **Start** button. The microwave oven will automatically operate for the pre-programmed time and temperature.

Operations

Example for Air Fry Max Auto operation

To set F2-4. Frozen tator tots with 2 servings for example, follow the instructions below.

Touch			Display shows		
Popcorn	Defrost	2 Air Fry Max Manual/Auto	START	🕒 🔊 🔒 📶 📶 9	g
Sensor Reheat/Cook	Auto Cook	Steam Cook	Heat	08:00	°F
			Filter	00:00	OZ
			AM PM		Lbs
1	2	3	START	🕒 🔊 🔒 📶 📶 9	g
2 4	5	6	Heat	00:00	°F
			Filter	00:00	OZ
			AM PM		Lbs
🕒 3sec	0	OK 3	START	🕒 🔊 🔒 📶 📶 9	g
🕒 3sec	🕒 3sec	🔒 3sec	Heat	00:00	°F
Stop	+30sec	Start	Filter	00:00	OZ
Eco			AM PM		Lbs
6 1	2	3	START	🕒 🔊 🔒 📶 📶 9	g
4	5	6	Heat	00:00	°F
			Filter	00:00	OZ
			AM PM		Lbs
🕒 3sec	0	OK	START	🕒 🔊 🔒 📶 📶 9	g
🕒 3sec	🕒 3sec	🔒 3sec	Heat	00:00	°F
Stop	+30sec	Start 6	Filter	00:00	OZ
Eco			AM PM		Lbs
			START	🕒 🔊 🔒 📶 📶 9	g
			Heat	05:00	°F
			Filter	00:00	OZ
			AM PM		Lbs

Time counting down

Cook No.	Food	Amount		Directions	Accessory Type
1	Frozen french fries	1	2 servings : 8 oz	Place frozen french fries on greased ceramic enamel tray. Put tray on high rack.	C / I
		2	4 servings : 16 oz		
2	Frozen hash brown patteis	1	2 servings : 4 ea	Place frozen hash brown patties on greased ceramic enamel tray. Put tray on high rack.	C / I
		2	4 servings : 8 ea		
3	Frozen potato wedges	1	2 servings : 8 oz	Place frozen potato wedges on greased ceramic enamel tray. Put tray on high rack.	C / I
		2	4 servings : 16 oz		
4	Frozen tator tots	1	2 servings : 8 oz	Place frozen tator tots on greased ceramic enamel tray. Put tray on high rack.	C / I
		2	4 servings : 16 oz		
5	Frozen chicken nuggets	1	1 serving : 8 oz	Place frozen chicken nuggets on greased ceramic enamel tray. Put tray on high rack.	C / I
		2	2 servings : 16 oz		
6	Frozen shrimp (breaded)	1	2 servings : 8 oz	Place frozen shrimp(breaded) on greased ceramic enamel tray. Put tray on high rack.	C / I
		2	4 servings : 16 oz		
7	Frozen chicken wings	1	1 serving : 8 oz	Place frozen chicken wings on greased ceramic enamel tray. Put tray on high rack.	C / I
		2	2 servings : 16 oz		
8	Drumsticks	1	1 serving : 12 oz	Place drumsticks on greased ceramic enamel tray. Put tray on high rack.	C / I
		2	2 servings : 24 oz		
9	Frozen onion rings	1	2 servings : 6 oz	Place frozen onion rings on greased ceramic enamel tray. Put tray on high rack.	C / I
		2	4 servings : 12 oz		

Operations

Sensor Reheat/Cook

The Sensor Cook mode lets you reheat and cook your favorite food using preset power levels and times. If the food is not thoroughly cooked after using the Sensor Cook feature, complete the cooking process by cooking the food for an additional amount of time.

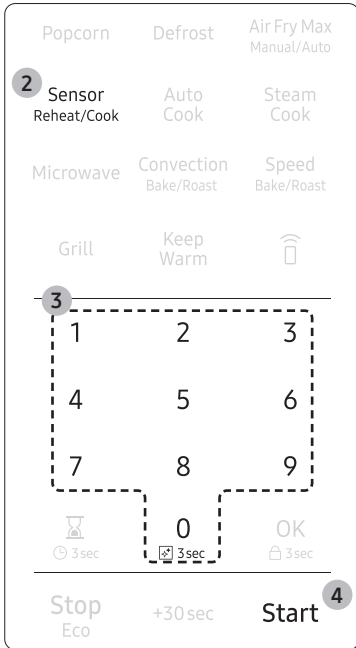

1. Place the food on the tray or the rack. (See **Accessory Combination Guide** on page 26)
2. Touch the **Sensor Reheat/Cook** button once for REHEAT. Touch the **Sensor Reheat/Cook** button twice for COOK.
3. Use the **number pad** to select the number that corresponds to the food item. (refer to the table on page 38.)
4. Touch the **Start** button. The microwave oven will automatically operate for the pre-programmed time and temperature.

Smart Features

Sensor Reheat/Cook Cooking Guide

For specific instructions for different kinds of food, see the table below.

Sensor Reheat

Cook No.	Food	Amount	Directions	Accessory Type
1	Beverage	1/2 - 2 cup	Use a measuring cup or mug and do not cover. Place the beverage in the microwave oven. After heating, stir well. Let the oven cool for at least 5 minutes before using it again.	G

Cook No.	Food	Amount	Directions	Accessory Type
2	Sauce/soup	1 - 4 servings * 1/2 cup for 1 serving	Cover the plate with a lid or vented plastic wrap. If the food is not as hot as you would like after using the Sensor Cooking Reheat function, continue heating using additional time and power. Stir the food once before serving. Let the microwave oven cool for at least 5 minutes before using it again.	G
3	Casserole	1 - 4 servings * 8 oz for 1 serving	Cover the plate with a lid or vented plastic wrap. If the food is not as hot as you would like after using the Sensor Cooking Reheat function, continue heating using additional time and power. Stir the food once before serving. Let the microwave oven cool for at least 5 minutes before using it again. Contents: Casserole, refrigerated foods.	G
4	Pizza	1 - 4 slices	Place 1 - 4 pizza slices on a microwavesafe plate with the wide ends of the slices towards the outside edge of the plate. Do not let the slices overlap. Do not cover. Let the microwave oven cool for at least 5 minutes before using it again.	G

Sensor cook

Cook No.	Food	Amount	Directions	Accessory Type
1	Potato	1 - 6 ea * 8 - 10 oz for 1 ea	Pierce each potato several times with a fork. Place on the turntable in a spoke-like fashion. After cooking, let the potatoes stand for 3 - 5 minutes. Let the microwave oven cool for at least 5 minutes before using it again.	G
2	Fresh vegetable	1 - 4 servings * 1/2 cup for 1 serving	Place the fresh vegetables in a microwavesafe ceramic, glass, or plastic dish and add 2 - 4 tbs. of water. Cover with a lid or vented plastic wrap. Stir before letting stand. Let the microwave oven cool for at least 5 minutes before using it again.	G
3	Frozen vegetable	1 - 4 servings * 1/2 cup for 1 serving	Place the frozen vegetables in a microwave-safe ceramic, glass, or plastic dish and add 2 - 4 tbs. of water. Cover with a lid or vented plastic wrap to cook. Stir before letting stand for 3 - 5 minutes. Let the microwave oven cool for at least 5 minutes before using it again.	G
4	Chicken pieces	1/2 - 2 lb	Pierce the chicken pieces a few times with a knife. Place the chicken breasts on a microwave safe plate not overlap and cover with vented plastic wrap. Cook to an internal temperature of 165 °F. Let stand for 5 minutes.	G

Operations

Auto Cook

The Auto Cook menu contains pre-set cooking programs for 41 different items. You do not need to set the cooking times or the power level..

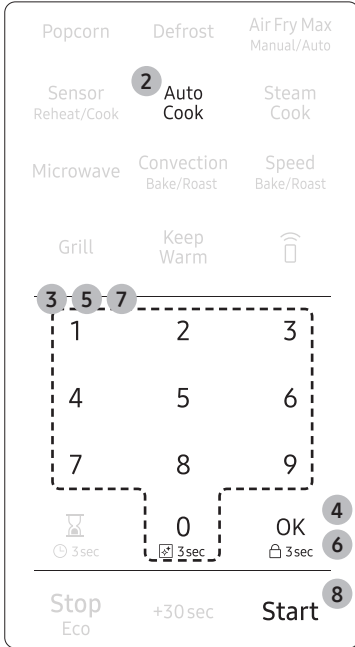

1. Place the food on the tray or the rack. (See **Accessory Combination Guide** on page 26)
2. Touch the **Auto Cook** button.
3. To select the number that corresponds to the category, touch the **number pad**. (Refer to the table that begins on page 38.)
4. Touch the **OK** button.
5. To select the number that corresponds to the food, touch the **number pad**. (Refer to the table that begins on page 38.) After selecting the food, if you do not need to set the amount, touch the **Start** button. If you need to set the amount, go to Step 6.
6. Touch the **OK** button.
7. Enter the amount of food by touching the **number pad**. (Refer to the table that begins on page 38.)
8. Touch the **Start** button. The microwave will automatically operate for the pre-programmed time.

Example for Auto Cook operation

To set A2-3. Green Beans with 3 servings for example, follow the instructions below.

Touch			Display shows
Popcorn	Defrost	Air Fry Max Manual/Auto	START [Icons] 9 Heat Filter 00:00 °F AM PM OZ Lbs
Sensor Reheat/Cook	2 Auto Cook	Steam Cook	
1	3 2	3	START [Icons] 9 Heat Filter 00:00 °F AM PM OZ Lbs
4	5	6	
[Hourglass] 3sec	0 [Checkmark] 3sec	OK 4 [Lock] 3sec	START [Icons] 9 Heat Filter 00:00 °F AM PM OZ Lbs
Stop Eco	+30sec	Start	
1	2	3 5	START [Icons] 9 Heat Filter 00:00 °F AM PM OZ Lbs
4	5	6	
[Hourglass] 3sec	0 [Checkmark] 3sec	OK 6 [Lock] 3sec	START [Icons] 9 Heat Filter 00:58 °F AM PM OZ Lbs
Stop Eco	+30sec	Start	
1	2	7 3	START [Icons] 9 Heat Filter 00:58 °F AM PM OZ Lbs
4	5	6	
[Hourglass] 3sec	0 [Checkmark] 3sec	OK [Lock] 3sec	START [Icons] 9 Heat Filter 00:00 °F AM PM OZ Lbs
Stop Eco	+30sec	Start 8	

Time counting down

Operations

Category	Cook No.	Food	Amount	Directions	Accessory Type	
1. Snacks	1	Macaroni and cheese	1	1 serving: ½ cup flake, 1 cup water	Use over 2 L microwave-safe bowl or cup with lid. Put hot water into microwave-safe bowl, add a pinch of salt and stir well. Cook covered.	G
			2	2 servings: 1 cup flake, 2 cups water		
	2	Frozen waffle	1	1 serving: 3 ea	Place the waffle on the metal tray, then place the tray on the high rack.	C
			2	2 servings: 6 ea		
	3	Fish sticks	1	1 serving: 8 oz, 227 g	Place the fish sticks on the high rack, then place the rack on the metal tray. Brush the fish stick with melted butter/oil.	D
			2	2 servings: 16 oz, 454 g		
	4	Hot dogs	1	2 ea	Pierce the hot dogs 3 times with a fork and place on a microwave-safe plate.	G
			2	4 ea		
2. Fresh vegetable	1	Broccoli	1	1 serving: ½ cup	Rinse and clean fresh broccoli and cut it into florets. Place the broccoli in a microwave safe bowl. Add 1 - 4 Tbsp of water (1 Tbsp per serving). Cover with vented (1 inch vent) plastic wrap while cooking. After heating, Stir well and stand for 2 - 3 minutes.	G
			2	2 servings: 1 cup		
			3	3 servings: 1.5 cups		
			4	4 servings : 2 cups		
	2	Carrots	1	1 serving: ½ cup	Rinse and clean fresh carrots and cut into 1 inch slices. Place the carrots in a microwave safe bowl. Add 1 - 4 Tbsp of water (1 Tbsp per serving). Cover with vented (1 inch vent) plastic wrap while cooking. After heating, Stir well and stand for 2 - 3 minutes.	G
			2	2 servings: 1 cup		
			3	3 servings: 1.5 cups		
			4	4 servings : 2 cups		
	3	Green beans	1	1 serving: ½ cup	Rinse and clean green beans. Place the green beans in a microwave safe bowl. Add 1 - 4 Tbsp of water (1 Tbsp per serving). Cover with vented (1 inch vent) plastic wrap while cooking. After heating, Stir well and stand for 2 - 3 minutes.	G
			2	2 servings: 1 cup		
			3	3 servings: 1.5 cups		
			4	4 servings: 2 cups		
	4	Zucchini	1	2 serving: 1 cup	Rinse and clean fresh zucchini and cut into 1 inch slices. Place the zucchini in a microwave safe bowl. Add 1 - 2 tsp of water (1 tsp per serving). Cover with vented (1 inch vent) plastic wrap while cooking. After heating, Stir well and stand for 2 - 3 minutes.	G
			2	4 servings: 2 cups		

Category	Cook No.	Food	Amount	Directions	Accessory Type	
3. Frozen vegetable	1	Broccoli	1	1 serving: ½ cup	Place the frozen broccoli in a microwave-safe bowl and add 1 - 4 Tbsp water. Cover with vented (1 inch vent) plastic wrap while cooking. After heating, Stir well and stand for 2 - 3 minutes.	G
			2	2 servings: 1 cup		
			3	3 servings: 1.5 cups		
			4	4 servings: 2 cups		
	2	Carrots	1	1 serving: ½ cup	Place the frozen carrots in a microwave-safe bowl and add 1 - 4 Tbsp water. Cover with vented(1 inch vent) plastic wrap while cooking. After heating, Stir well and stand for 2 - 3 minutes.	G
			2	2 servings: 1 cup		
			3	3 servings: 1.5 cups		
			4	4 servings: 2 cups		
	3	Green beans	1	1 serving: ½ cup	Place the frozen green beans in a microwave-safe bowl and add 1 - 4 Tbsp water. Cover with vented(1 inch vent) plastic wrap while cooking. After heating, Stir well and stand for 2 - 3 minutes.	G
			2	2 servings: 1 cup		
			3	3 servings: 1.5 cups		
			4	4 servings: 2 cups		
	4	Peas	1	1 serving: ½ cup	Place the frozen peas in a microwave-safe bowl and add 1 - 4 Tbsp water. Cover with vented(1 inch vent) plastic wrap while cooking. After heating, Stir well and stand for 2 - 3 minutes.	G
			2	2 servings: 1 cup		
			3	3 servings: 1.5 cups		
			4	4 servings: 2 cups		
4. Meal	1	Frozen dinner	-	1 serving * 150 g mashed potato * 100 g vegetable * 200 g meat	Remove the food from its wrapping and follow the instructions on the box for covering and letting stand.	G
	2	Oatmeal	1	1 pack: 28 g oatmeal, 160 ml water	Follow the package directions for the recommended amount of water needed. Place the oatmeal in the microwave-safe bowl. Cover with vented(1 inch vent) plastic wrap while cooking. After heating, Stir well and stand for 2 - 3 minutes.	G
			2	2 packs: 56 g oatmeal, 320 ml water		
	3	Rice	1	2 servings: 78 g rice, 180 ml water	Place the rice and water in a microwave-safe bowl. Cover with vented(1 inch vent) plastic wrap while cooking. After heating, Stir well and stand for 2 - 3 minutes.	G
			2	4 servings: 156 g rice, 360 ml water		

Operations

Category	Cook No.	Food	Amount	Directions	Accessory Type	
4. Meal	4	Quinoa	1	2 servings: 170 g quinoa, 425 ml water	Place the quinoa and water in a microwave-safe bowl. Cover with vented(1 inch vent) plastic wrap while cooking. After heating, Stir well and stand for 2 - 3 minutes.	G
			2	4 servings: 340 g quinoa, 850 ml water		
	5	Bacon (pre-cooked)	1	2 servings	Place paper towels on plate and arrange bacon on towels. Do not overlap.	G
			2	4 servings		
			3	6 servings		
5. Pizza / Bread	1	Frozen pizza (individual 6 inch)	-	6 inch	Place the pizza on the metal tray, then place the tray on the high rack.	C
	2	Frozen pizza (regular 12 inch)	-	12 inch	Place the pizza on the metal tray, then place the tray on the high rack.	C
	3	Biscuits (refrigerated)	-	10 ea	Place the biscuits on the greased metal tray, then place the tray on the low rack.	A
	4	Box cake mix	-	1/2 package: cake mix 440 - 460 g	Follow the package directions for the recommended amount of water and another ingredients needed. Pour the batter into 2 - 8 inch microwave-safe round cake pans, then place the pan on the low rack.	A
	5	Brownie mix	-	1 package: 1 box (520 g) brownie mix, 1/2 cup butter, 1/2 cup water, 2 eggs	Follow the package directions for the recommended amount of water and another ingredients needed. Pour the batter into microwave-safe glass brownie pan, then place the pan on the low rack.	A
	6	Frozen cookies	-	5 ea	Place 5 cookies on the greased metal tray, then place the tray on low rack.	A
	7	Frozen French toast	1	2 servings	Place the frozen french toast on the high rack.	D
			2	4 servings		
6. Melt / Soften	1	Melt butter	1	1 stick	Remove the wrapping and cut the butter in half vertically. Place the butter into microwave-safe cup and cover with wax paper. Stir well after finishing and let stand for 1 - 2 minutes.	G
			2	2 sticks		
	2	Soften butter	1	1 stick	Remove the wrapping and cut the butter in half vertically. Place the butter into microwave-safe cup and cover with wax paper. Stir well after finishing and let stand for 1 - 2 minutes.	G
			2	2 sticks		

Category	Cook No.	Food	Amount	Directions	Accessory Type
6. Melt / Soften	3	Melt chocolate	- 1 cup	Place the chocolate chips or squares in a microwave-safe bowl. Stir well after finishing and let stand for 1 - 2 minutes.	G
	4	Softened ice cream	1 1 pint	Remove the lid of carton. Place the carton in the center of the microwave.	G
			2 4 pints		
	5	Softened cream cheese	- 1 package (8 oz)	Unwrap the cream cheese and place on a microwave-safe container.	G
	6	Melt cheese	- 1 cup	Place the cheese in a microwave-safe bowl and cover with wax paper. Stir well after finishing and let stand for 1 - 2 minutes.	G
7	Melt marshmallows	- 10 oz	Place the marshmallows in a microwave-safe bowl. Stir well after finishing and let stand for 1 - 2 minutes.	G	
7. Poultry / Seafood	1	Chicken breast	1 2 ea (6 oz/ each)	Place the chicken breasts on the high rack, then place the rack on the metal tray. When the oven beeps, flip chicken and restart the oven.	D
			2 4 ea (6 oz/ each)		
	2	Whole chicken	- 1 ea (2.5 - 3 lb)	Fold the wings under the chicken. Place the chicken on the low rack, then place the rack on the metal tray. Brush the whole chicken with melted butter or oil and seasonings.	B
	3	White fish fillet	1 2 ea (4 oz/ each)	Spray the high rack with non stick spray. Place the fillets(cod, pollack etc) on the high rack, then place the rack on the metal tray.	D
			2 4 ea (4 oz/ each)		
	4	Salmon fillet	1 2 ea (4 oz/ each)	Spray the high rack with non stick spray. Place the salmon fillets on the high rack, then place the rack on the metal tray.	D
			2 4 ea (4 oz/ each)		
5	Shrimp (fresh)	1 1/2 lb	Place the shrimp on the metal tray, then place the tray on the high rack. When the oven beeps, turn over the shrimp and restart the oven.	C	
		2 1 lb			

Operations

Category	Cook No.	Food	Amount		Directions	Accessory Type
8. Meat	1	Roast beef	1	2 lb	Brush the beef with melted butter or oil and seasonings. Place the beef on the low rack, then place the rack on the metal tray. When the oven beeps, flip beef and restart the oven.	B
			2	3 lb		
	2	Ground beef	1	½ lb	Place the ground beef in a microwave-safe dish. When the oven beeps, stir and restart the oven.	G
			2	1 lb		
	3	Pork ribs	1	1 lb	Brush the pork ribs with melted butter or oil and seasonings. Place the pork ribs on the high rack, then place the rack on the metal tray. When the oven beeps, flip pork ribs and restart the oven.	D
			2	2 lb		
	4	Boneless pork chops	1	½ lb	Brush the boneless pork chops with melted butter or oil and seasonings. Place the boneless pork chops on the high rack, then place the rack on the metal tray. When the oven beeps, flip boneless pork chops and restart the oven.	D
			2	1 lb		
	5	Pork tenderloin	1	1 lb	Brush the pork tenderloin with melted butter or oil and seasonings. Place the pork tenderloin on the low rack, then place the rack on the metal tray. When the oven beeps, flip pork tenderloin and restart the oven.	B
			2	2 lb		

Steam Cook

The Steam Cook menu contains pre-set cooking programs for 7 different items. You do not need to set the cooking times or the power level.

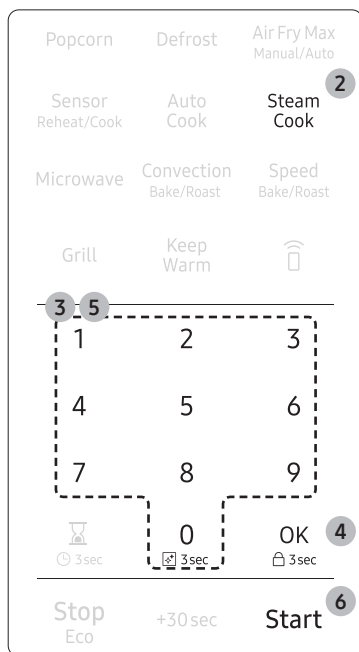

1. Add 1 cup (200 ml) of water to the Steamer. Place the food on the tray. (See **Accessory Combination Guide** on page 26)
2. Touch the **Steam Cook** button.
3. Use the **number pad** to select the number that corresponds to the food. (refer to the table on page 38.) If you do not need to set the amount, press the **Start** button.
4. Touch the **OK** button.
5. Enter the amount of food by touching the **number pad** (1 or 2). (Refer to the table on page 38.)
6. Touch the **Start** button. The microwave oven will automatically operate for the pre-programmed time and temperature.

Pure steam cooking guide

The Pure Steamer is based on the principle of steam cooking, and is designed for fast, healthy cooking in your Samsung Microwave oven.

This accessory is ideal for cooking rice, pasta, vegetables, etc. in record time, while preserving their nutritional values. The Pure Steamer set is made up of 3 items:



Bowl



Insert tray



Lid

All parts withstand temperatures from -10 °C to 130 °C.

Suitable for freezer storage. Can also be used separately or together.

Operations

Conditions of use

- **Do not use:**
to cook foods with a high sugar or fat content, with the grill or rotating heat function or on a hob.
- Wash all parts well in soapy water before first use.
- To find out cooking times, please refer to the instructions in the table on next page.

Maintenance

- Your steamer can be washed in a dishwasher.
- When washing by hand, use hot water and washing-up liquid. Do not use abrasive pads.
- Some foods (such as tomato) may discolour the plastic. This is normal and not a manufacturing fault.

Defrosting

Place the frozen food in the steam bowl without the lid. The liquid will remain in the bottom of the pot and will not harm the food.

Handling of Pure Steamer

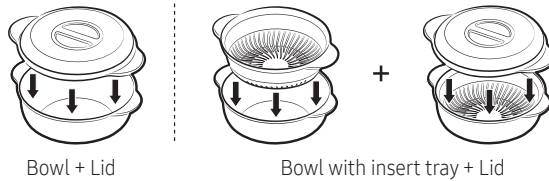

Precautions

- Take special care when opening the lid of your steamer, because the steam escaping may be very hot.
- Use oven gloves when handling after cooking.

CAUTION

Do not operate the Grill and Combi mode with Pure Steamer.

Operation Mode	Microwave	Grill / Combi
Pure Steamer	O	X

Example for Steam Cook operation

To set **St-2 Carrots** with **2 servings** for example, follow the instructions below.

Touch	Display shows																		
<table border="1"> <tr> <td>Popcorn</td> <td>Defrost</td> <td>Air Fry Max Manual/Auto</td> </tr> <tr> <td>Sensor Reheat/Cook</td> <td>Auto Cook</td> <td>2 Steam Cook</td> </tr> </table>	Popcorn	Defrost	Air Fry Max Manual/Auto	Sensor Reheat/Cook	Auto Cook	2 Steam Cook	<table border="1"> <tr> <td>START</td> <td>🕒</td> <td>🔒</td> <td>📶</td> <td>📶</td> <td>9</td> </tr> <tr> <td>Heat</td> <td>Filter</td> <td>AM PM</td> <td>88:00</td> <td>°F</td> <td>OZ Lbs</td> </tr> </table>	START	🕒	🔒	📶	📶	9	Heat	Filter	AM PM	88:00	°F	OZ Lbs
Popcorn	Defrost	Air Fry Max Manual/Auto																	
Sensor Reheat/Cook	Auto Cook	2 Steam Cook																	
START	🕒	🔒	📶	📶	9														
Heat	Filter	AM PM	88:00	°F	OZ Lbs														
<table border="1"> <tr> <td>1</td> <td>3 2</td> <td>3</td> </tr> <tr> <td>4</td> <td>5</td> <td>6</td> </tr> </table>	1	3 2	3	4	5	6	<table border="1"> <tr> <td>START</td> <td>🕒</td> <td>🔒</td> <td>📶</td> <td>📶</td> <td>9</td> </tr> <tr> <td>Heat</td> <td>Filter</td> <td>AM PM</td> <td>88:00</td> <td>°F</td> <td>OZ Lbs</td> </tr> </table>	START	🕒	🔒	📶	📶	9	Heat	Filter	AM PM	88:00	°F	OZ Lbs
1	3 2	3																	
4	5	6																	
START	🕒	🔒	📶	📶	9														
Heat	Filter	AM PM	88:00	°F	OZ Lbs														
<table border="1"> <tr> <td>🕒 3sec</td> <td>0 3sec</td> <td>OK 4 3sec</td> </tr> <tr> <td>Stop Eco</td> <td>+30sec</td> <td>Start</td> </tr> </table>	🕒 3sec	0 3sec	OK 4 3sec	Stop Eco	+30sec	Start	<table border="1"> <tr> <td>START</td> <td>🕒</td> <td>🔒</td> <td>📶</td> <td>📶</td> <td>9</td> </tr> <tr> <td>Heat</td> <td>Filter</td> <td>AM PM</td> <td>88:58</td> <td>°F</td> <td>OZ Lbs</td> </tr> </table>	START	🕒	🔒	📶	📶	9	Heat	Filter	AM PM	88:58	°F	OZ Lbs
🕒 3sec	0 3sec	OK 4 3sec																	
Stop Eco	+30sec	Start																	
START	🕒	🔒	📶	📶	9														
Heat	Filter	AM PM	88:58	°F	OZ Lbs														
<table border="1"> <tr> <td>1</td> <td>5 2</td> <td>3</td> </tr> <tr> <td>4</td> <td>5</td> <td>6</td> </tr> </table>	1	5 2	3	4	5	6	<table border="1"> <tr> <td>START</td> <td>🕒</td> <td>🔒</td> <td>📶</td> <td>📶</td> <td>9</td> </tr> <tr> <td>Heat</td> <td>Filter</td> <td>AM PM</td> <td>88:58</td> <td>°F</td> <td>OZ Lbs</td> </tr> </table>	START	🕒	🔒	📶	📶	9	Heat	Filter	AM PM	88:58	°F	OZ Lbs
1	5 2	3																	
4	5	6																	
START	🕒	🔒	📶	📶	9														
Heat	Filter	AM PM	88:58	°F	OZ Lbs														
<table border="1"> <tr> <td>🕒 3sec</td> <td>0 3sec</td> <td>OK 3sec</td> </tr> <tr> <td>Stop Eco</td> <td>+30sec</td> <td>Start 6</td> </tr> </table>	🕒 3sec	0 3sec	OK 3sec	Stop Eco	+30sec	Start 6	<table border="1"> <tr> <td>START</td> <td>🕒</td> <td>🔒</td> <td>📶</td> <td>📶</td> <td>9</td> </tr> <tr> <td>Heat</td> <td>Filter</td> <td>AM PM</td> <td>88:00</td> <td>°F</td> <td>OZ Lbs</td> </tr> </table>	START	🕒	🔒	📶	📶	9	Heat	Filter	AM PM	88:00	°F	OZ Lbs
🕒 3sec	0 3sec	OK 3sec																	
Stop Eco	+30sec	Start 6																	
START	🕒	🔒	📶	📶	9														
Heat	Filter	AM PM	88:00	°F	OZ Lbs														

Time counting down

Operations

Category	Cook No.	Food	Amount	Directions	Accessory Type	
Steam Cook	1	Broccoli	1	1 serving (6 oz)	Rinse and clean fresh broccoli and cut it into florets. Add 200 ml water into steam bowl. Put the broccoli on the insert tray and place the steam bowl. Cover the lid. After cooking, stand for 2 - 3 minutes.	H
			2	2 servings (12 oz)		
	2	Carrots	1	1 serving (6 oz)	Rinse and clean fresh carrots cut it into inch slices. Add 200 ml water into steam bowl. Put the carrots on the insert tray and place the steam bowl. Cover lid. After cooking, stand for 2 - 3 minutes.	H
			2	2 servings (12 oz)		
	3	Cauliflowers	1	1 serving (6 oz)	Rinse and clean fresh cauliflowers and cut it into florets. Add 200 ml water into steam bowl. Put the cauliflowers on the insert tray and place the steam bowl. Cover the lid. After cooking, stand for 2 - 3 minutes.	H
			2	2 servings (12 oz)		
	4	Spinach	1	1 serving (3 oz)	Rinse and clean fresh spinach. Add 200 ml water into steam bowl. Put the spinach on the insert tray and place the steam bowl. Cover the lid. After cooking, stand for 2 - 3 minutes.	H
			2	2 servings (6 oz)		
	5	Squash	1	1 serving (14 oz)	Weigh the fresh squash wash and cut into similar size or half. Add 200 ml water into steam bowl. Put the squash on the insert tray and place the steam bowl. Cover the lid. After cooking, stand for 2 - 3 minutes.	H
			2	2 servings (28 oz)		
	6	White fish fillet	1	1 serving (130 g)	Rinse and clean fresh fillet. Add 200 ml water into steam bowl. Put the white fish fillet on the insert tray and place the steam bowl. Cover the lid. After cooking, stand for 2 - 3 minutes.	H
			2	2 servings (260 g)		
	7	Salmon fillet	1	1 serving (130 g)	Rinse and clean fresh fillet. Add 200 ml water into steam bowl. Put the salmon fillet on the insert tray and place the steam bowl. Cover the lid. After cooking, stand for 2 - 3 minutes.	H
			2	2 servings (260 g)		
	8	Shrimp	1	2 servings (8 oz)	Rinse and clean fresh shrimp. Add 200 ml water into steam bowl. Put the shrimp on the insert tray and place the steam bowl. Cover the lid. After cooking, stand for 2 - 3 minutes.	H
			2	4 servings (16 oz)		

Microwave

Microwave mode can operate with One-stage cooking mode and Multi-stage cooking mode (maximum of 2 stages). You can also change power level (10 - 100) if needed.

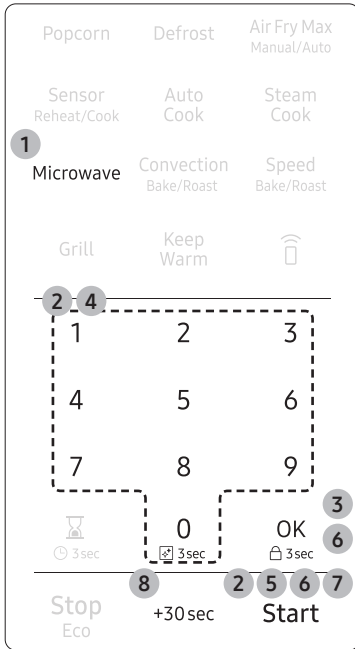

1. Touch the **Microwave** button.
(You can skip this step and start at the next step.)
2. Use the **number pad** to set a cooking time. You can enter a time from one second to 99 minutes and 99 seconds. (For example, to set a cooking time of 20 minutes, enter **2, 0, 0**.) If you do not need to set the power level, just touch the **Start** button. The microwave will automatically operate at the High power level. If you want to change the power level, go to Step 3.
3. If you want to set the power level to a level other than High, touch the **OK** button.
4. Touch the **number pad** that corresponds to the power level (Refer to the table below).
5. Touch the **Start** button to operate One-stage cooking mode. If you want to use Multi-stage cooking, go to step 6.
6. To use Multi-stage cooking mode, touch **OK**, enter cooking time for 2nd stage and then touch **Start** if you do not need to set 2nd stage power level.
7. If you want to set the power level of 2nd stage, follow steps 3 and 4. Touch the **Start** button to start cooking.
8. If you want to add 30 seconds of cooking time, touch **+30sec** button. You can adjust the cooking time while the microwave oven is operating.

No.	Power Level	Description	No.	Power Level	Description
1	10	Warm	6	60	Simmer
2	20	Low	7	70	Medium high
3	30	Defrost	8	80	Reheat
4	40	Medium low	9	90	Sauté
5	50	Medium	10	100	High

Operations

Convection Bake/Roast

The Convection Bake/Roast mode uses dry heat to cook and brown food. A high speed fan circulates hot air inside the oven to heat food quickly and evenly. When you cook using convection, you would generally use the low rack.

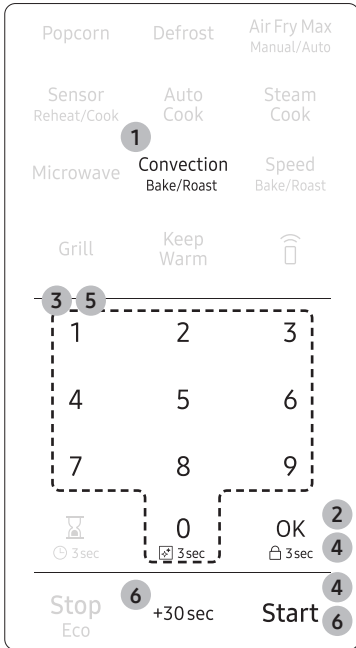

1. Touch the **Convection Bake/Roast** button once for **BAKE**. Touch the **Convection Bake/Roast** button twice for **ROAST**.
2. Touch the **OK** button.
3. To set the temperature, touch the **number pad**. (Refer to the temperature table below.)

Bake	Roast
100 °F	-
200 °F	200 °F
225 °F	225 °F
250 °F	250 °F
275 °F	275 °F
300 °F	300 °F
325 °F	325 °F
350 °F	350 °F
375 °F	375 °F
400 °F	400 °F
425 °F	425 °F

4. Touch the **OK** button. If you want to preheat the oven, touch the **Start** button without setting cook time.

NOTE

If there is no action within 60 minutes after preheating the oven, the oven will turn off automatically.

5. Use the **number pad** to set a cooking time.
6. Touch the **Start** button to begin convection cooking. If you want to add 30 seconds of cooking time, touch **+30sec**. You can adjust the cooking time while the microwave oven is operating.

NOTE

- If the oven reaches the temperature setting, 'Beep' sound will occur in both preheat and cooking mode.
- To maintain a constant temperature, keep the oven door closed while the food is cooking. Open as infrequently as possible.
- While operating the oven, if you want to change the temperature setting, touch the **OK** button, touch the **number pad** and then touch the **OK** button.

Speed Bake/Roast

The combination cooking feature allows you to cycle automatically between microwave and Bake/Roast cooking. The food will be moist as well as crisp and brown. This type of cooking is ideal for large food that requires long cooking times when prepared in a conventional oven (such as large roasts, whole chickens, etc.). When combination cooking, use the low rack to allow air to circulate completely around the dish. To use combination cooking:

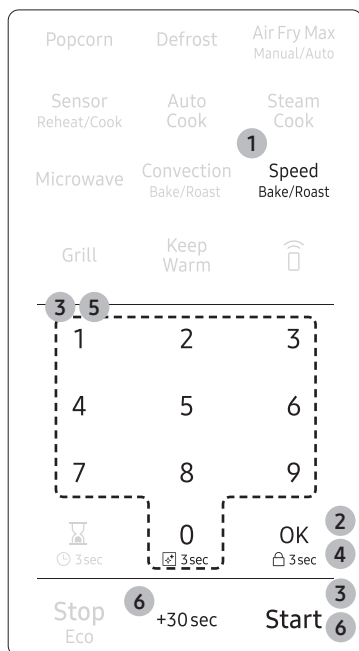

1. Touch the **Speed Bake/Roast** button once for SPEED BAKE. Touch the **Speed Bake/Roast** button twice for SPEED ROAST.
2. Touch the **OK** button.
3. Use the **number pad** to set a cooking time. If you do not need to set the power level, just touch the **Start** button. The Microwave will operate at a pre-programmed power level. If you want to adjust the power level, go to Step 3.
4. Touch the **OK** button.
5. To set the power level, touch the **number pad** refer to the table on page 50. (default : 2)

No.	1	2	3	4
Power level	10	30	50	70

6. Touch the **Start** button. If you want to add 30 seconds of cooking time, touch **+30sec** button. You can adjust the cooking time while the microwave oven is operating.

NOTE

- This mode combines microwave energy with hot air. This combination reduces the cooking time while giving the food a brown and crispy surface.
- The vent fan operates at low speed while the oven operates in Speed Bake/Roast mode.

Cookware for cooking with speed bake/roast

Use only cookware that is specially manufactured for microwave ovens. Do not use metal cookware with this combination mode. Do not use any type of plastic cookware, as it can melt.

Operations

Food suitable for speed bake/roast

Other food suitable for this combination mode cooking include all kinds of previously cooked food which needs reheating and browning (e.g. baked pasta), as well as food which requires a short cooking time to brown the top of the food. This mode can also be used for thick food portions that benefit from a browned and crispy top (e.g. chicken pieces, which you turn over half way through cooking). Other food suitable for this cooking mode include a variety of meats and poultry as well as frozen snacks and pizza.

Speed Bake/Roast Cooking Guide

Use the cooking mode, power levels, and times in this table as guides for speed cooking.

NOTE

Always use oven gloves when taking the food out of the microwave oven.

Type	Food	Amount	Mode	Time (Min)	Directions
Pizza	Frozen pizza (individual)	6 inch	Speed Bake 30 %	12 - 16	Place the pizza on the low rack, then place the rack on the ceramic enamel tray.
	Frozen pizza (regular)	12 inch	Speed Bake 30 %	15 - 21	Place the pizza on the low rack, then place the rack on the ceramic enamel tray.
Meat	Roast beef (medium)	2 - 3 lb 900 - 1400 g	1 st Speed Roast 30 % 2 nd Convection Roast 325 °F	1 st 25 - 40 2 nd 25 - 40	Brush beef/lamb with oil and spice it with pepper, salt and paprika. Place the roast on the low rack, then place the rack on the ceramic enamel tray. After cooking, wrap in aluminium foil and let it stand for 10 - 15 minutes.
	Steaks	0.5 - 1.0 lb 200 - 500 g	1 st Speed Roast 30 % 2 nd Speed Roast 10 %	1 st 7 - 13 2 nd 10 - 15	Place the steak on the high rack, then place the rack on the ceramic enamel tray. After cooking, Let the steak rest for 5 minutes before slicing.
	Pork tenderloin	0.5 - 1.0 lb 200 - 500 g	1 st Speed Roast 30 % 2 nd Speed Roast 10 %	1 st 12 - 18 2 nd 10 - 16	Place the pork on the low rack, then place the rack on the ceramic enamel tray. After cooking, Let the steak rest for 5 minutes before slicing.

Type	Food	Amount	Mode	Time (Min)	Directions
Meat	Roast chicken	3 – 4 lb 1400 - 1800 g	1 st Speed Roast 50 %	1 st 25 - 40	Fold the wings under the chicken. Place the chicken on the low rack, then place the rack on the ceramic enamel tray. Brush the chicken with melted butter/oil and seasonings. Put chicken breast side down for the 1st, then breast side up for the 2nd.
			2 nd Speed Roast 30 %	2 nd 15 - 30	
	Bone-in chicken pieces	2 - 4 pieces	1 st Speed Roast 50 %	1 st 12 - 18	Place the chicken pieces on the high rack, then place the rack on the ceramic enamel tray. Put chicken skin side down for the 1st, then skin side up for the 2nd.
			2 nd Grill	2 nd 10 - 20	
Snack (Frozen)	Chicken nuggets	5 - 10 ea	Speed Roast 30 %	5 - 10	Place the chicken nuggets on the ceramic enamel tray, then place the tray on the high rack.
	Chicken wings	10 - 20 ea	Speed Roast 50 %	12 - 17	Place the chicken wings on the high rack, then place the rack on the ceramic enamel tray.
	French fries	6 - 12 oz 170 - 340 g	Speed Bake 10 %	10 - 15	Place the french fries on the ceramic enamel tray, then place the tray on the high rack.

Operations

Grill

Grill mode adds texture and taste to your food. When grilling, use the low or high rack accessory. Use the low rack when the height of food is such that the food would touch the upper heater if placed on the high rack.

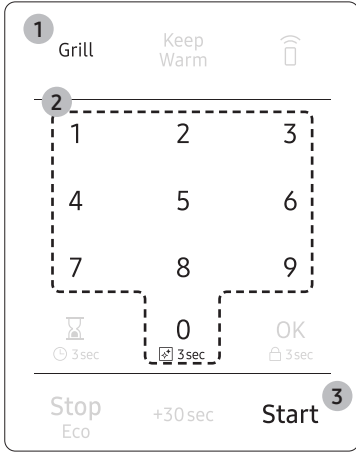

1. Touch the **Grill** button.
2. Use the **number pad** to set a cooking time.
3. Touch the **Start** button to begin Grilling.

NOTE

The vent fan operates at low speed while the oven operates in Grill mode.

Keep Warm

You can keep cooked food warm in your microwave oven for up to 99 minutes and 99 seconds.

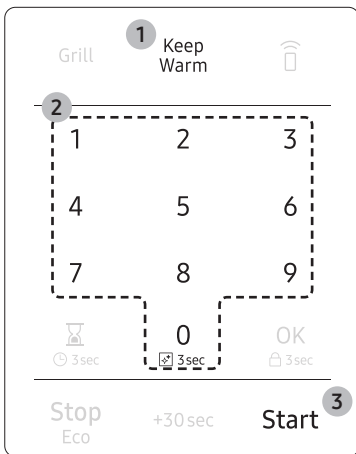

1. Touch the **Keep Warm** button.
2. Enter the time by touching the **number pad**. If you don't set the cook time, your oven will maintain the Keep Warm function for 99 minutes.
3. Touch the **Start** button.

NOTE

- **Keep Warm** operates for up to 99 minutes and 99 seconds.
- **Food that is cooked covered** should also be covered during **Keep Warm**.
- Pastry items (pies, turnovers, etc.) should be uncovered during **Keep Warm**.
- Complete meals kept warm on a dinner plate can be covered during **Keep Warm**.

Below are the amounts of food we recommend by Food Type when you use Keep Warm function.

Food Type	Recommended Quantity
Liquid	1 - 2 cups
Dry	5 - 10 oz.

Steam Clean

The steam provided by the steam clean system will soak the cavity surface. After using the steam clean function, you can easily clean the cavity of the oven.

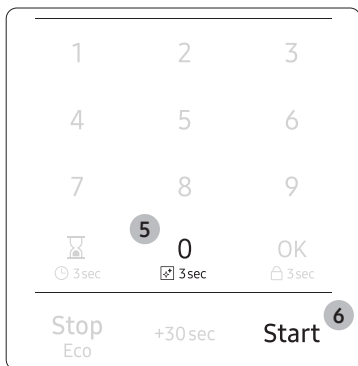

1. Open the door.
2. Carefully pour about 2fl.oz. of water into a wide plate.
3. Place the plate on the tray of the microwave oven.
4. Close the door.
5. Touch the 0 button for 3 seconds.
6. Touch the Start button. Steam clean will operate for 6 minutes and 30 seconds. The length of time cannot be modified.
7. When the cleaning time is over, the oven will beep. Open the door.
8. Clean the cavity of the oven with a dry dishtowel. Remove the turntable and wipe under the rack with a piece of paper towel.

NOTE

- Use this function only after the oven has completely cooled.
- Use normal tap water only. Do not use distilled water.

CAUTION

The water in the oven will be very hot due to the steam cleaning function. Wipe up carefully.

Cookware guide

To cook food in your microwave oven, microwaves must be able to penetrate the food without being reflected or absorbed by the dish.

It is important to choose the correct cookware, therefore look for cookware that is marked microwave-safe.

The following table lists various types of cookware and indicates if and how they should be used in a microwave oven.

Recommended cooking utensils

- **Glass and glass-ceramic bowls and dishes** — Use for heating or cooking.
- **Microwavable plastic wrap** — Use to cover. Leave a small opening for steam to escape and avoid placing it directly on the food.
- **Wax paper** — Use as a cover to prevent spattering.
- **Paper towels and napkins** — Use for short-term heating and covering. They absorb excess moisture and prevent spattering. Do not use recycled paper towels, which may contain metal and can catch fire.
- **Paper plates and cups** — Use for short-term heating at low temperatures. Do not use recycled paper, which may contain metal and can catch fire.
- **Thermometers** — Use only those labeled "Microwave Safe" and follow all directions. Check the food in several places. Conventional thermometers may be used once the food has been removed from the oven.

Limited use items

- **Aluminum foil** — Use narrow strips of foil to prevent overcooking of exposed areas. Using too much foil can damage your oven, so be careful.
- **Ceramic, porcelain, and stoneware** — Use these if they are labeled "Microwave Safe". If they are not labeled, test them to make sure they can be used safely. Never use dishes with metallic trim.
- **Plastic** — Use only if labeled "Microwave Safe". Other plastics can melt.
- **Straw, wicker, and wood** — Use only for short-term heating, as they are flammable.

Not recommended

- **Glass jars and bottles** — Regular glass is too thin to be used in a microwave and can shatter.
- **Paper bags** — These are a fire hazard, except for popcorn bags that are designed for microwave use.
- **Styrofoam plates and cups** — These can melt and leave an unhealthy residue on food.
- **Plastic storage and food containers** — Containers such as margarine tubs can melt in the microwave.

Testing utensils

If you are not sure whether a dish is microwave-safe or not, you can perform this test:

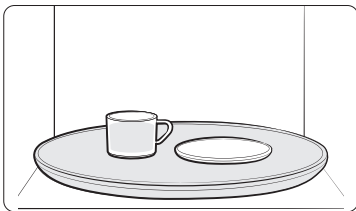

1. Fill a 1 cup glass measuring cup with water and put it inside your oven, next to the dish you want to test.
2. Set the microwave to 1 minute using the **number pad**, and then touch the **Start** button. This will heat the glass and dish for one minute at High power.

When the microwave stops, the water should be warm and the dish you are testing should be cool.

If the dish is warm, then it is absorbing microwave energy and is not acceptable for use in the microwave.

Cooking guide

Microwave energy actually penetrates food and is attracted to and absorbed by the water, fat, and sugar molecules in the food. The microwaves cause the molecules in the food to move rapidly. The rapid movement of these molecules creates friction and the resulting heat cooks the food.

Cooking techniques

Stirring

Stir foods such as casseroles and vegetables while cooking to distribute heat evenly. Food at the outside of the dish absorbs more energy and heats more quickly, so stir from the outside to the center. The oven will turn off when you open the door to stir your food.

Arrangement

Arrange unevenly shaped foods, such as chicken pieces or chops, with the thicker, meatier parts toward the outside of the turntable where they receive more microwave energy. To prevent overcooking, place thin or delicate parts toward the center of the turntable.

Shielding

Shield food with narrow strips of aluminum foil to prevent overcooking. Areas that need shielding include poultry wing-tips, the ends of poultry legs, and the corners of square baking dishes. Use only small amounts of aluminum foil. Larger amounts can damage your oven.

Turning

Turn foods over midway through cooking to expose all parts to microwave energy. This is especially important with large items such as roasts.

Standing

Food cooked in the microwave builds up internal heat and continues to cook for a few minutes after the oven stops. Let food stand to complete cooking, especially food such as roasts and whole vegetables. Roasts need this time to complete cooking in the center without overcooking the outer areas. All liquids, such as soup or hot chocolate, should be shaken or stirred when cooking is complete. Let liquids stand a moment before serving. When heating baby food, stir well and test the temperature before serving.

Adding Moisture

Microwave energy is attracted to water molecules. Food that is uneven in moisture content should be covered or allowed to stand so that the heat disperses evenly. Add a small amount of water to dry food to help it cook.

Venting

After covering a dish with plastic wrap, vent the plastic wrap by turning back one corner so excess steam can escape.

Cooking guide

Recommended cooking utensils

- Dense foods, such as potatoes, take longer to heat than lighter foods. Food with a delicate texture should be heated at a low power level to prevent it from becoming tough.
- Altitude and the type of cookware you are using can affect cooking time. When trying a new recipe, use the minimum cooking time and check the food occasionally to prevent overcooking.
- Food with a non-porous skin such as potatoes or hot dogs should be pierced to prevent bursting.
- Frying with oil or fat is not recommended. Fat and oil can suddenly boil over and cause severe burns.
- Some ingredients heat faster than others. For example, the jelly inside a jelly doughnut will be hotter than the dough. Keep this in mind to avoid burns.
- Home canning in the microwave oven is not recommended because all harmful bacteria may not be destroyed by the microwave heating process.
- Although microwaves do not heat the cookware, the heat from the food is often transferred to the cookware. Always use pot holders when removing food from the microwave and instruct children to do the same.
- Making candy in the microwave is not recommended as candy can heat to very high temperatures. Keep this in mind to avoid injury.

Guide for cooking eggs in your microwave

- Never cook eggs in the shell and never warm hard-cooked eggs in the shell. They can explode.
- Always pierce whole eggs to keep them from bursting.
- Cook eggs just until set. They become tough if overcooked.

Guide for cooking vegetables in your microwave

- Vegetables should be washed just before cooking. Often, no extra water is needed. If you are cooking dense vegetables such as cubed potatoes, carrots, or green beans, add about $\frac{1}{4}$ cup water.
- Small vegetables (sliced carrots, peas, lima beans, etc.) will cook faster than larger ones.
- Whole vegetables, such as potatoes, acorn squash, or corn on the cob, should be arranged in a circle on the turntable before cooking. They will cook more evenly if turned over after half the cooking time.
- Always place vegetables like asparagus and broccoli with the stem ends pointing towards the edge of the dish and the tips toward the center.
- When cooking cut vegetables, always cover the dish with a lid or vented microwavable plastic wrap.
- Whole, unpeeled vegetables such as potatoes, squash, eggplant, etc., should have their skin pricked in several spots before cooking to prevent them from bursting.
- For more even cooking, stir or rearrange whole vegetables halfway through the cooking time.
- Generally, the denser the food, the longer the standing time. (Standing time refers to the time necessary for dense, large foods and vegetables to finish cooking after they come out of the oven.) A baked potato can stand on the counter for five minutes before cooking is completed, while a dish of peas can be served immediately.

Cleaning and maintaining your microwave oven

Keeping your microwave oven clean improves its performance, wards off unnecessary repairs, and lengthens its life.

Cleaning the exterior

It's best to clean spills on the outside of your microwave oven as they occur. Use a soft cloth and warm, soapy water. Rinse and dry.

CAUTION

Do not get water into the vents. Never use abrasive products or chemical solvents such as ammonia or alcohol as they can damage the appearance of your microwave.

WARNING

Unplug the microwave before cleaning.

Cleaning under your microwave oven

Regularly clean grease and dust from the bottom of your microwave using a solution of warm water and soap.

Cleaning the control panel

Wipe with a damp cloth and dry thoroughly. Do not use cleaning sprays, large amounts of soap and water, abrasives, or sharp objects on the panel as it is easily damaged.

Cleaning the door and door seals

Always ensure that the door seals are clean and that the door closes properly. Take particular care when cleaning the door seals to ensure that no particles accumulate and prevent the door from closing correctly. Wash the glass door with very mild soap and water. Be sure to use a soft cloth to avoid scratching.

NOTE

If steam accumulates inside or outside the oven door, wipe with a soft cloth. Steam can accumulate when you operate the oven when humidity is high and in no way indicates microwave leakage.

Cleaning the interior

CAUTION

To avoid injury, ensure that the microwave oven has cooled down before cleaning it.

Cleaning and maintaining your microwave oven

CAUTION

Remove the glass tray from the oven when cleaning the oven or tray. To prevent the tray from breaking, handle it with care and do not put it in water immediately after cooking. Wash the tray carefully in warm sudsy water or in the dishwasher.

See the **Steam Clean** section on page 53.

Cleaning the turntable and roller rings

Clean the roller rings periodically and wash the turntable as required. The turntable can be washed safely in your dishwasher.

Storing and repairing your microwave oven

If you need to store your microwave oven for a short or extended period of time, choose a dust-free, dry location. Dust and dampness may adversely affect the functionality of the microwave parts.

WARNING

Do not repair, replace, or service any part of your microwave oven yourself. Allow only a qualified service technician to perform repairs. If the oven is faulty and needs servicing, or you are in doubt about its condition, unplug the oven from the power outlet and contact your nearest service center.

Do not use the oven if the microwave oven is damaged, in particular, if the door or door seals are damaged or the door does not close properly. This can be caused by a broken hinge, a worn out seal or distorted/bent casing.

Do not remove the oven from its casing.

This microwave oven is for home use only and is not intended for commercial use.

Replacing the cooktop/night light

When replacing the cooktop/night light, make sure that you are wearing gloves to avoid injury from the heat of the bulb.

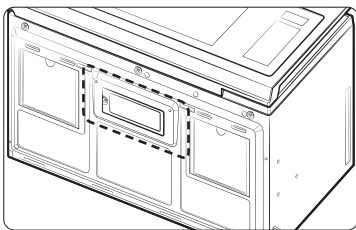

1. Unplug the oven or turn off the power at the main power supply.
2. Remove the screw from the light cover and lower the cover.
3. Disconnect the wire connectors.
4. Remove the screw securing the LED lamp board.
5. Replace the LED lamp board.

Replacing the oven light

When replacing the oven light, make sure that you are wearing gloves to avoid injury from the heat of the bulb.

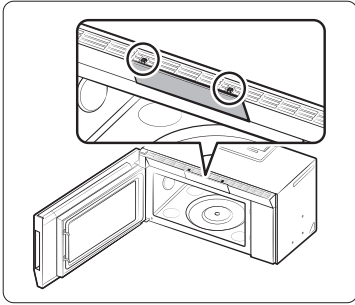

1. Unplug the oven or turn off the power at the main power supply.
2. Open the door.
3. Press the hook above the grille to open the front of it.
4. Remove the charcoal filter, if present.
5. Remove the screw securing the lamp cover.
6. Remove the bulb by pulling it out gently.
7. Replace the bulb with a 20 watt halogen bulb.
8. Replace the bulb holder.
9. Close the grille front.
10. Plug the oven in or turn on the power at the main power supply. Reset the clock.

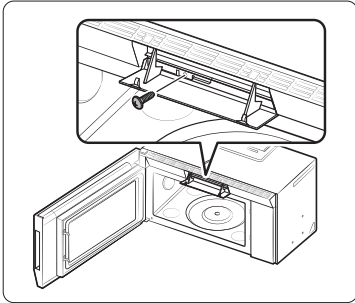

Cleaning the grease filter

Your microwave oven has two metal reusable grease filters. The grease filters should be removed and cleaned at least once every four months or as required.

NOTE

Your microwave oven has a filter reminder function. See page 23 for details.

WARNING

To avoid risk of personal injury or property damage, do not operate the oven hood without the filters in place.

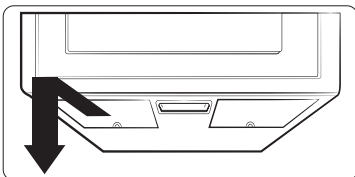

1. To remove the filter, slide it to the left (or right) using the tab.

Cleaning and maintaining your microwave oven

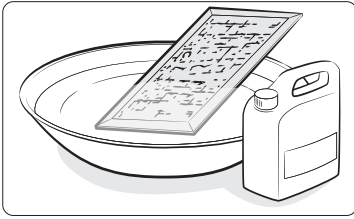

2. Soak the grease filter in hot water and a mild soap. Rinse well and shake to dry. Brushing the filter lightly can remove embedded dirt.

WARNING

Do not use ammonia or put the grease filter in the microwave oven. The aluminum will darken.

3. To re-install the filter, slide it into the frame slot on the left (or right), and then push it upwards and to the right (or left) to lock it.

Replacing the charcoal filter

If your oven is vented to the inside, the charcoal filter should be replaced every 6 to 12 months and more often if necessary. The charcoal filter cannot be cleaned. To order a new charcoal filter, contact the Parts Department at 1-800-627-4368 or your Samsung dealer. You can also order online at www.samsungparts.com

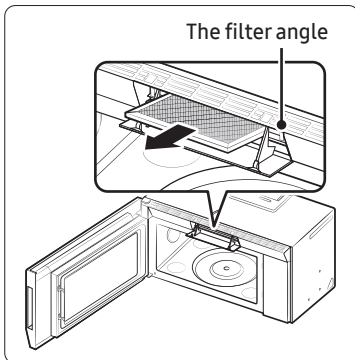

1. Unplug the oven or turn off the power at the main power supply.
2. Open the door.
3. Press the hook above the grille to open the front of it.
4. Push the hook and remove the old filter.

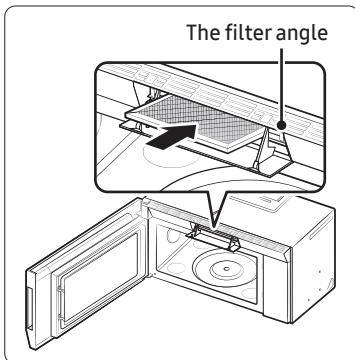

5. Slide a new charcoal filter into place. The filter should rest at the angle shown.
6. Close the grille front. Plug the oven in or turn on the power at the main power supply. Reset the clock.

NOTE

Please be advised that the Samsung warranty does NOT cover service calls to explain product operation, correct improper installation, or perform normal cleaning or maintenance.

Troubleshooting

If you encounter a problem with your oven, first check the table below and try the recommendations. If a problem persists, or if an information code keeps appearing on the display, contact a local Samsung service center.

Installation

Problem	Possible cause	Solution
General		
The buttons cannot be touched properly.	Foreign matter may be caught between the buttons.	Remove the foreign matter and try again.
	For touch models: Moisture is on the exterior.	Wipe the moisture from the exterior.
	Child Lock is activated.	Deactivate Child Lock.
The time is not displayed.	Power is not supplied.	Make sure power is supplied. Confirm the microwave is plugged in. Check your fuses or circuit breakers.
	The Eco (power-saving) function is set.	Turn off the Eco function.
The oven does not work.	Power is not supplied.	Make sure power is supplied. Confirm the microwave is plugged in. Check your fuses or circuit breakers.
	The door is open.	Close the door and try again.
	The door open safety mechanisms are covered by foreign matter.	Remove the foreign matter and try again.
The oven stops while in operation.	The user has opened the door to turn food over.	After turning the food over, touch the Start button again to start operation.

Cleaning and maintaining your microwave oven

Problem	Possible cause	Solution
The power turns off during operation.	The oven has been cooking for an extended period of time.	After the oven has cooked for an extended period of time, let the oven cool.
	The cooling fan is not working.	Listen for the sound of the cooling fan.
	Trying to operate the oven without food inside.	Put food in the oven.
	There is not enough ventilation space around the oven.	There are intake/exhaust outlets on the front and rear of the oven for ventilation. Check the installation guide and make sure that the microwave is far enough away from walls and cabinets for proper ventilation.
	Several appliances or devices are plugged into the same outlet.	Unplug all other appliances or devices from the outlet.
There is no power to the oven.	Power is not supplied.	Make sure power is supplied. Confirm the microwave is plugged in. Check your fuses or circuit breakers.
There is a popping sound during operation.	Cooking food in a sealed container or using a container with a tight lid may cause popping sounds.	Do not cook food in sealed containers or in containers with tight lids. Expanding steam from the cooking food can cause the containers to burst or the lids to pop off.
The oven exterior gets too hot during operation.	There is not enough ventilation space around the oven.	There are intake/exhaust outlets on the front and rear of the oven for ventilation. Check the installation guide and make sure that the microwave is far enough away from walls and cabinets for proper ventilation.
	Objects are on top of the oven.	Remove all objects on the top of the oven.
The door cannot be opened properly.	Food residue is stuck between the door and oven interior.	Clean the oven and then open the door.
The oven does not heat.	The oven may not work if too much food is being cooked or improper cookware is being used.	To test the oven, put one cup of water in a microwave-safe container, put the container in the oven, and then run the microwave for 1 - 2 minutes to check whether the water is heated. If the water is heated, reduce the amount of food and start the function again. Use a cooking container with a flat bottom.

Problem	Possible cause	Solution
Heating is weak or slow.	The oven may not work if too much food is being cooked or improper cookware is being used.	To test the oven, put one cup of water in a microwave-safe container, put the container in the oven, and then run the microwave for 1 - 2 minutes to check whether the water is heated. If the water is heated, reduce the amount of food and start the function again. Use a cooking container with a flat bottom.
The warm function does not work.	The oven may not work if too much food is being warmed or improper cookware is being used.	To test the oven, put one cup of water in a microwave-safe container, put the container in the oven, and then run the microwave for 1 - 2 minutes to check whether the water is heated. If the water is heated, reduce the amount of food and start the function again. Use a cooking container with a flat bottom.
The thaw function does not work.	The oven may not work if too much food is being thawed or improper cookware is being used.	To test the oven, put one cup of water in a microwave-safe container, put the container in the oven, and then run the microwave for 1 - 2 minutes to check whether the water is heated. If the water is heated, reduce the amount of food and start the function again. Use a cooking container with a flat bottom.
The interior light is dim or does not turn on.	The door has been left open for a long time.	The interior light may automatically turn off when the Eco function operates. Close and reopen the door or touch the Stop/Eco button.
	The interior light is covered by foreign matter.	Clean the inside of the oven and check again.
A beeping sound occurs during cooking.	If the Auto Cook function is being used, this beeping sound means it's time to flip the food.	After turning over the food, touch the Start button again to restart operation.
The oven is not level.	The oven is installed on an uneven surface.	Make sure the oven is installed on flat, stable surface.
There are sparks during cooking.	Metal containers are used during cooking or thawing.	Do not use metal containers.
When power is connected, the oven immediately starts to work.	The door is not properly closed.	Close the door and check again.

Cleaning and maintaining your microwave oven

Problem	Possible cause	Solution
There is electricity coming from the oven.	The power source or power outlet is not properly grounded.	Make sure the power source and power outlet are properly grounded.
There is water dripping.	Water or steam may be generated by the cooking or defrosting process, depending on the food. This is not an oven malfunction.	Let the oven cool and then wipe with a dry dish towel.
There is steam through a crack in the door.	Water or steam may be generated by the cooking or defrosting process, depending on the food. This is not an oven malfunction.	Let the oven cool and then wipe with a dry dish towel.
There is water left in the oven.	Water or steam may be generated by the cooking or defrosting process, depending on the food. This is not an oven malfunction.	Let the oven cool and then wipe with a dry dish towel.
The brightness inside the oven varies.	Brightness changes depending on power output changes according to function.	Power output changes during cooking are not malfunctions. This is not an oven malfunction.
Cooking is finished, but the cooling fan is still running.	To ventilate the oven, the cooling fan continues to run for about 3 minutes after cooking is complete.	This is not an oven malfunction.
Touching the Start button operates the oven.	This happens when the oven was not operating.	The microwave oven is designed to start operating when you touch the Start button if it was not operating.
Turntable		
While turning, the turntable comes out of place or stops turning.	There is no roller ring, or the roller ring is not properly in place.	Install the roller ring and then try again.
The turn table drags while turning.	The roller ring is not properly in place, there is too much food, or the container is too large and touches the inside of the microwave.	Adjust the amount of food. Do not use containers that are too large.
The turn table rattles while turning and is noisy.	Food residue is stuck to the bottom of the oven.	Remove any food residue stuck to the bottom of the oven.

Problem	Possible cause	Solution
Grill		
Smoke comes out during operation.	During initial operation, smoke may come from the heating elements when you first use the oven.	This is not a malfunction. After you run the oven 2 - 3 times, it should stop.
	Food is on the heating elements.	Let the oven cool and then remove the food from the heating elements.
	Food is too close to the grill.	Put the food a suitable distance away while cooking.
	Food is not properly prepared and/or arranged.	Make sure food is properly prepared and arranged.
Oven		
The oven does not heat.	The door is open.	Close the door and try again.
Smoke comes out during preheating.	During initial operation, smoke may come from the heating elements when you first use the oven.	This is not a malfunction. After you run the oven 2 - 3 times, it should stop.
	Food is on the heating elements.	Let the oven cool and then remove the food from the heating elements.
There is a burning smell or a burnt plastic smell when using the oven.	Plastic or non-heat resistant cookware is used.	Use glass cookware suitable for high temperatures.
There is a bad smell coming from inside the oven.	Food residue or plastic has melted and stuck to the interior.	Use the steam function and then wipe the interior of the microwave with a dry cloth. You can put a measuring cup containing a cup of water and a lemon slice inside and run the oven to remove the odor more quickly.
The oven does not cook properly.	The oven door is frequently opened during cooking.	Do not open the door frequently unless you are cooking things that need to be turned. If you open the door often, the interior temperature will be lowered and this may affect the results of your cooking.
	The oven controls are not correctly set.	Set the oven controls correctly and try again.
	The grill or other accessories are not correctly inserted.	Insert the accessories correctly.
	The wrong type or size of cookware is used.	Reset the oven controls or use suitable cookware with flat bottoms.

Cleaning and maintaining your microwave oven

Information codes

If the oven fails to operate, you may see an information code on the display. Check the table below for the code, and then follow the directions.

Code	Description	Action
C-20	The temperature sensor read the temperature incorrectly.	Touch the Stop/Eco button and operate again. If it appears again, turn off the microwave oven, let it sit for more than 30 seconds, and then try setting again. If this code re-appears, call your local Samsung Customer Care Center.
C-21	Temperature sensor detects a higher temperature than the set temperature.	Turn off the microwave oven and let it cool, then try the setting again. If this code re-appears, call your local Samsung Customer Care Center.
C-F0	The microwave has sensed an internal communications failure.	Unplug the power cord of the oven, and contact a local Samsung Customer Care Center.
C-A1	The oven has failed to sense the opening or closing of the damper for 1 minute.	
C-F1	Only occurs when EEPROM Read or Write is not working.	
C-d0	Control buttons are touched over 10 seconds.	Clean the keys and check if there is water on the surface around key. If it appears again, turn off the microwave oven, let it sit for more than 30 seconds, and then try setting again. If this code re-appears, call your local Samsung Customer Care Center.
C-F2	There is a button malfunction.	Stop the oven and then try again. If this code re-appears, call your local Samsung Customer Care Center.

Appendix

Specifications

Model	ME90H1780RAA
Oven Cavity	1.7 cu ft
Controls	10 power levels, including Defrost
Timer	99 minutes, 99 seconds
Power Source	120 VAC, 60 Hz
Power Consumption	1700 Watt Microwave / 1800 Watt Heater
Microwave Power Output	950 Watts
Cook Top Light	LED lamp (2 EA)
Oven Light	20 Watt halogen lamp
Oven Cavity Dimensions (inches)	20 ¹ / ₈ " (W) x 10 ⁵ / ₁₆ " (H) x 14" (D)
Outside Dimensions (inches)	29 ⁷ / ₈ " (W) x 17 ¹ / ₁₆ " (H) x 16 ¹¹ / ₁₆ " (D)
Shipping Dimensions (inches)	33 ³ / ₈ " (W) x 20 ¹¹ / ₁₆ " (H) x 19 ³ / ₈ " (D)
Net/Shipping Weight	78.8 lbs / 90.3 lbs (34.86 kg / 40.96 kg)

Warranty

Samsung MICROWAVE OVEN

LIMITED WARRANTY TO ORIGINAL PURCHASER WITH PROOF OF PURCHASE

This Samsung brand product, as supplied and distributed by Samsung ELECTRONICS AMERICA, INC. (Samsung) and delivered new, in the original carton to the original consumer purchaser, is warranted by Samsung against manufacturing defects in materials or workmanship for the limited warranty period, starting on the date of delivery to the original consumer purchaser, of:

One (1) Year Parts and Labor

Ten (10) Years Magnetron Part (Part Only)

This limited warranty is valid only on products purchased and used in the United States that have been installed, operated, and maintained according to the instructions attached to or furnished with the product. To receive warranty service, the purchaser must contact Samsung at the address or phone number provided below for problem determination and service procedures. Warranty service can only be performed by a Samsung authorized service center. The original dated bill of sale and/or proof of delivery must be presented upon request as proof of purchase to Samsung or Samsung's authorized service center to receive warranty service.

Samsung will provide in-home service within the contiguous United States during the warranty period at no charge, subject to availability of Samsung authorized servicers within the customer's geographic area. If in-home service is not available, Samsung may elect, at its option, to provide transportation of the product to and from an authorized service center. If the product is located in an area where service by a Samsung authorized servicer is not available, you may be responsible for a trip charge or required to bring the product to a Samsung authorized service center for service.

To receive in-home service, product must be unobstructed and accessible to the service agent.

During the applicable warranty period, a product will be repaired, replaced, or the purchase price refunded, at the sole option of Samsung. Samsung may use new or reconditioned parts in repairing a product, or replace the product with a new or reconditioned product. Replacement parts and products are warranted for the remaining portion of the original product's warranty or ninety (90) days, whichever is longer. All replaced parts and products are the property of Samsung and you must return them to Samsung.

This limited warranty covers manufacturing defects in materials or workmanship encountered in normal household, noncommercial use of this product and shall not cover the following: damage that occurs in shipment, delivery, installation, and uses for which this product was not intended; damage caused by unauthorized modification or alteration of the product; product where the original factory serial numbers have been removed, defaced, changed in any way, or cannot be readily determined; cosmetic damage including scratches, dents, chips, and other damage to the product's finishes; damage caused by abuse, misuse, overheating due to overcooking, glass tray or turntable, pest infestations, accident, fire, floods, or other acts of nature or God; damage caused by use of equipment, utilities, services, parts, supplies, accessories, applications, installations, repairs, external wiring or connectors not supplied or authorized by Samsung; damage caused by incorrect electrical line current, voltage, fluctuations and surges; damage caused by failure to operate and maintain the product according to instructions; in-home instruction on how to use your product; service to correct installation not in accordance with electrical or plumbing codes or correction of household electrical or plumbing (i.e., house wiring, fuses, or water inlet hoses); and reduced magnetron power output related to normal aging.

The cost of repair or replacement under these excluded circumstances shall be the customer's responsibility. Visits by an authorized servicer to explain product functions, maintenance or installation are not covered by this limited warranty. Please contact Samsung at the number below for assistance with any of these issues.

Samsung will charge a repair fee for replacing an accessory or repairing cosmetic damage if the damage to the unit and/or damage to or loss of the accessory was caused by the customer. Items this covers include:

- Dented, scratched, or broken door, handle, out-panel, or control panel
- Broken or lost tray, guide roller, coupler, filter, or wire rack

Parts that Samsung has determined can be replaced by the user may be sent to the customer for installation. In Samsung's discretion, an authorized servicer can be dispatched to perform such installation.

EXCLUSION OF IMPLIED WARRANTIES

IMPLIED WARRANTIES, INCLUDING THE IMPLIED WARRANTIES OF MERCHANTABILITY OR FITNESS FOR A PARTICULAR PURPOSE, ARE LIMITED TO ONE YEAR OR THE SHORTEST PERIOD ALLOWED BY LAW. Some states do not allow limitations on how long an implied warranty lasts, so the above limitations or exclusions may not apply to you. This warranty gives you specific rights, and you may also have other rights, which vary from state to state.

LIMITATION OF REMEDIES

YOUR SOLE AND EXCLUSIVE REMEDY IS PRODUCT REPAIR, PRODUCT REPLACEMENT, OR REFUND OF THE PURCHASE PRICE AT Samsung's OPTION, AS PROVIDED IN THIS LIMITED WARRANTY. Samsung SHALL NOT BE LIABLE FOR SPECIAL, INCIDENTAL OR CONSEQUENTIAL DAMAGES, INCLUDING BUT NOT LIMITED TO TIME WAY FROM WORK, HOTELS AND/OR RESTAURANT MEALS, REMODELING EXPENSES, LOSS OF REVENUE OR PROFITS, FAILURE TO REALIZE SAVINGS OR OTHER BENEFITS REGARDLESS OF THE LEGAL THEORY ON WHICH THE CLAIM IS BASED, AND EVEN IF Samsung HAS BEEN ADVISED OF THE POSSIBILITY OF SUCH DAMAGES. Some states do not allow exclusion or limitation of incidental or consequential damages, so the above limitations or exclusions may not apply to you. This warranty gives you specific rights, and you may also have other rights, which vary from state to state.

Samsung does not warrant uninterrupted or error-free operation of the product. No warranty or guarantee given by any other person, firm, or corporation with respect to this product shall be binding on Samsung.

To obtain warranty service, please contact Samsung at:

Samsung Electronics America, Inc.

700 Sylvan Ave, Englewood Cliffs, NJ 07632

1-800-SAMSUNG (726-7864) and www.samsung.com



Scan the QR code* or visit
www.samsung.com/spsn
to view our helpful
How-to Videos and Live Shows
* Requires reader to be installed on your
smartphone

Scan this with your smartphone

COUNTRY	CONTACT CENTER	WEB SITE
U.S.A Consumer Electronics	1-800-SAMSUNG (726-7864)	www.samsung.com/us/support
CANADA	1-800-SAMSUNG (726-7864)	www.samsung.com/ca/support (English) www.samsung.com/ca_fr/support (French)

