

LG Sound Suite AI

Wi-Fi SOUNDBAR

OWNER'S MANUAL

Please read this manual carefully before operating your set and retain it for future reference.

H7

Soundbar Quick Guide

| Installing and using the Product

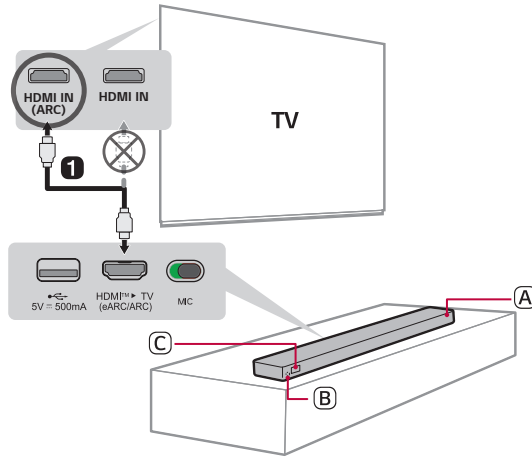

- 1** Connect the product to your TV via an HDMI cable. (→ See “Connecting TV with an HDMI Cable”)





- A** Soundbar
- B** Remote Control Receiver
- C** Display window

- 1** Using the HDMI cable, connect the **HDMI™ ► TV (eARC / ARC)** terminal on the back of the product to the **HDMI IN (ARC)** terminal on the TV as shown in the picture.
- 2** Press the **Source**  button repeatedly until [HDMI ARC] appears on the display window.
- 3** Enter the [Speaker] settings in the TV's menu and set the output to [HDMI ARC]. Settings and menu items may vary depending on the TV manufacturer.



2 Connect the product to your TV via Bluetooth (→ See “Connecting TV via Bluetooth”)

- 1 Press the **Bluetooth pair**  button. After a moment,  blinks on the display window.
- 2 Press the Settings button on the TV remote control and enter the [Speaker] menu to set the output speaker to **[Bluetooth]**.
- 3 Find and select “LG Sound Suite series model name”.
- 4 When the product is connected to the TV via **Bluetooth**, the connected device name appears on the display window.

3 Connecting the product to your smartphone via Bluetooth (→ See “Connecting via Bluetooth”)

- 1 Tap the **Settings**  button on your smartphone and select **Bluetooth**. Turn on the **Bluetooth** function. (Off > On)
- 2 Press the **Bluetooth pair**  button. After a moment,  blinks on the display window.
- 3 Find and select “LG Sound Suite series model name”.
- 4 When the product is connected to your smartphone via **Bluetooth**, the connected device name appears on the display window.

4 Connecting to a USB Storage Device (→ See “Connecting to a USB Storage Device”)

- 1 Plug the USB storage device into the USB port on the back of the product.
- 2 Press the **Source**  button repeatedly until  appears on the display window.
- 3 Press the **Play/Pause**  button on the remote control to enjoy the music.

5 Connecting the product to your smartphone via Wi-Fi (→ See “Connecting with the product via LG ThinQ app”)



(Android)



(iOS)



- 1 Connect your smartphone to Wi-Fi.
- 2 Install the **LG ThinQ app** on Google Play or the App Store.
- 3 Run the **LG ThinQ app** and follow the instructions.
- 4 The product will connect to your smartphone and you can control the product with **LG ThinQ app**.

Using Dolby Atmos FLEXCONNECT

The product connects with LG Sound Suite products to provide optimal acoustics in any room or location. Connectivity is possible through the **LG ThinQ app**'s Dolby Atmos FLEXCONNECT settings without the need for complicated wires.

Connect your LG Sound Suite products for optimal acoustics.

Scan the QR code below for more information of using Dolby Atmos FLEXCONNECT with LG Sound Suite products.



✔ Note

- W7 requires a TV or soundbar with Dolby Atmos FLEXCONNECT support for connection.
 - After registering the soundbar in the **LG ThinQ app**, connect W7 through [Dolby Atmos FlexConnect] in the **LG ThinQ app**. (Refer to the W7 owner's manual for detailed connection instructions.)
- W7 can be assigned to a Dolby Atmos FLEXCONNECT group, but does not operate in Dolby Atmos FLEXCONNECT mode.

Table of Contents

Soundbar Quick Guide

- 2 Installing and using the Product

Exploring the Product

- 6 Front
- 10 Back
- 11 Remote Control

Installation

- 15 Mounting the Product to a Wall
- 19 Connecting the power
- 20 Connecting TV with an HDMI Cable
- 22 Connecting TV via Bluetooth

Connecting

- 23 Connecting with the product via LG ThinQ app
- 25 Connecting via Bluetooth
- 27 Connecting to a USB Storage Device

Playback

- 29 Works with Apple AirPlay
- 30 Spotify Connect
- 30 Tidal Connect
- 31 LG Radio+

Various settings for convenience

- 32 Convenient functions
- 33 Using Sound Follow
- 34 Sound tuning
- 35 Using MY function
- 36 Using Room Calibration Pro
- 38 Using Sound Effects
- 41 Using Ambient lighting
- 42 Using Standby Mode lighting
- 43 Resetting the Product

Using Dolby Atmos FLEXCONNECT

- 44 About Dolby Atmos FLEXCONNECT
- 47 Dolby Atmos FLEXCONNECT Setup with Soundbar
- 50 Dolby Atmos FLEXCONNECT Connection Combinations

Safety Precautions

- 52 Safety and Regulatory
- 55 Prevention of product misuse

Before Reporting Product Malfunction

- 59 Troubleshooting

Appendix

- 64 Specifications
- 65 Registered Trademarks and Licenses
- 66 What You Need to Know about Network Services
- 66 Open Source Software Notice Information
- 67 Handling the Product

Exploring the Product

Front

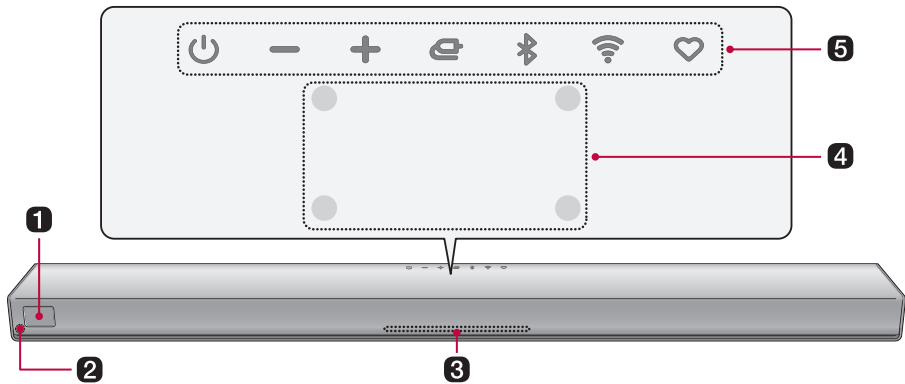

1 Display Window

Displays the status of the product.

- The display window can be controlled as auto, off, and on. (→ See “Display window setting”)

2 Remote Control Receiver

This receives wireless signals from the remote control.

3 Lighting indicator



Options such as input mode and volume light up. (→ See “Lighting Indicator”)

4 Built-in microphone

This is used when operating the Dolby Atmos FLEXCONNECT calibration.

5 Power

This turns the product on/off.

- If you press and hold the **Power**  button for more than 3 seconds when turning off the product, the Wi-Fi connection will be deactivated. To maintain the Wi-Fi connection, briefly press the **Power**  button to turn off the product.

Volume

Adjusts the sound volume.

Source

Press the button repeatedly to select the desired function or input mode.

- HDMI ARC: Connects the product to a TV that supports an ARC or E-ARC.
- Wi-Fi: Connects the product via Wi-Fi.
- **Bluetooth**: Connects the product via **Bluetooth**.
- USB: Connects the product to a USB storage device.

Bluetooth pair

It allows you to pair your **Bluetooth** device such as a smartphone to this product for one minutes. (→ See "Connecting via Bluetooth")

Wi-Fi

It goes to the Wi-Fi function directly.

MY

- Press the button to use the **MY** functions. (→ See "Using MY function") Before using **MY** functions, set up in the **LG ThinQ app**.
 - Press the button twice to use Room Calibration Pro. The speaker sound is optimized for your listening space. (→ See "Using Room Calibration Pro")
-

Note

- To reduce power consumption, the product will automatically turn off after 15 minutes of no input signal from an external device.
 - The microphone is used solely for audio functionality and does not collect the user's sound.
-

Lighting Indicator

Power on / Power off



- When the power is turned on, the lighting indicator lights up amber.
- The color of the lighting indicator may differ depending on the selected source.



- When the power is turned off, the middle of the lighting indicator lights up white.
- Currently in standby mode. The product is ready to receive signals or establish network connection.



- When the power is turned off, the lighting indicator turns off.
- Currently powered off. Press the **Power** (⏻) button briefly to start using the product.

Volume Adjustment

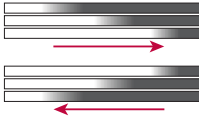

- Volume up: The lighting indicator enlarges to the right.
- Volume down: The lighting indicator reduces to the left.
- If you press **Volume** (⊖) (⊕) button even when the level has reached the maximum or minimum, the lighting indicator will blink 3 times.

Source



HDMI ARC

The lighting indicator lights up white.



Wi-Fi ready

The lighting indicator blinks green.



Wi-Fi connected

The lighting indicator lights up green.

Apple AirPlay, Spotify, Tidal connect

When playing music via Apple AirPlay, Spotify, or Tidal Connect, the lighting indicator lights up green.



Bluetooth ready

The lighting indicator blinks blue.



Bluetooth connected

The lighting indicator lights up blue.



USB storage mode ready

The lighting indicator blinks amber.



USB storage connected

The lighting indicator blinks amber and then turns off.

Source



Room Calibration Pro in progress

The lighting indicator displays dynamic, multicolored light animations.



Room Calibration Pro completed

The lighting indicator lights up with multicolored lighting.

✔ Note

- Press the **Lighting**  button on the remote control to turn the lighting indicator on or off.
- You can adjust the brightness of the lighting indicator by using the **LG ThinQ app**.
- Once the connection is complete, the lighting Indicator will light up white only when the product is in networked standby mode.

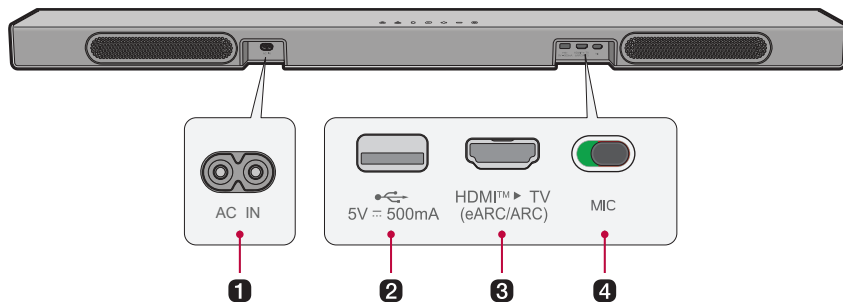

1 AC IN

Plug in the power cord.

2 USB port

Plug in a USB storage device to play music with the product.

3 HDMI™ ► TV (eARC / ARC)

Plug in an HDMI cable to connect the TV to the product.

4 MIC (Microphone) switch

Switch the microphone on or off.

- The Dolby Atmos FLEXCONNECT calibration function is not available when the MIC switch is in OFF state. ( OFF,  ON)

✓ Note

The microphone is used solely for audio functionality and does not collect the user's sound.

Remote Control

You can use the remote to control all functions of the product, from turning the power on/off to enabling cinematic sound.

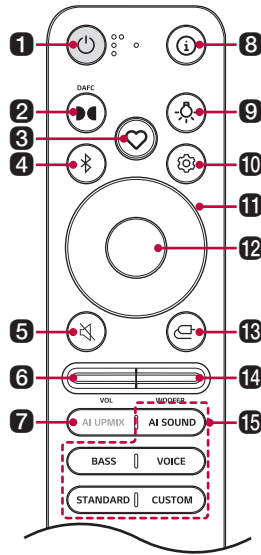

1 Power

Turns the product on/off.

2 Dolby Atmos FLEXCONNECT status

Displays the Dolby Atmos FLEXCONNECT connection status on the display window.

3 MY

- Press the button to use the **MY** functions. (→ See “Using MY function”) Before using **MY** functions, set up in the **LG ThinQ app**.
- Press the button twice to use Room Calibration Pro. The speaker sound is optimized for your listening space. (→ See “Using Room Calibration Pro”)

4 Bluetooth pair

It allows you to pair your **Bluetooth** device such as a smartphone to this product for one minute. (→ See “Connecting via Bluetooth”)

5 Mute

This turns off the sound from the product.

6 Volume 

Adjusts the sound volume.

7 AI UPMIX

Uses artificial intelligence to analyze sound and add virtual channels to improve sound quality.

8 Information 

Press the button to show the information such as codec name, file name or service name on the display window.

9 Lighting 

Press the button to turn the ambient lighting on or off. (→ See “Using Ambient lighting”)

10 Settings 

It allows you to adjust the settings of this product: SOUND TUNING, NIGHT TIME, DISPLAY. Press **Settings**  button repeatedly to select a function, and set the function using Up/Down/Left/Right buttons.

- SOUND TUNING: You can adjust the sound level of each speaker and sound tone. (→ See “Sound tuning”)
 - NIGHT TIME: This reduces the general sound volume, but raises the volume of soft and delicate sounds. This is useful when enjoying music or a movie late at night. (→ See “Night Time setting”)
 - DISPLAY: The display window can be controlled as auto, off, and on. (→ See “Display window setting”)
-

11 Up/Down/Left/Right 

These buttons are used to adjust the settings of the convenient functions.

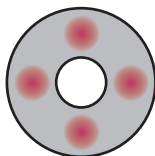

Up/Down: This scrolls through the folders on the USB storage device. You can press the button to select the desired folder.

Left/Right: To play the previous song, press **Left** button. To play the next song, press **Right** button.

12 Play/Pause 

To play or pause a song, press this button.

13 Source 

Press the button repeatedly to select the desired input mode or function.

14 Subwoofer Volume 

Adjusts the subwoofer volume level.

15 Sound Effects

Press the button to select a desired sound effect.

- AI SOUND (AI Sound Pro+): Artificial intelligence selects the optimal sound settings to suit your content.
 - BASS (Bass Boost): Bass sounds are enhanced.
 - VOICE (Clear Voice Pro+): Improves the clarity of voices.
 - STANDARD: You can enjoy optimized sound.
 - CUSTOM: Select the custom sound effect you set in the **LG ThinQ app**.
-

Replacement of Battery

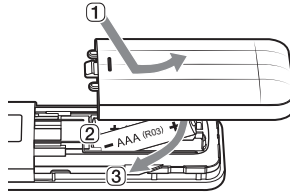

Use AAA 1.5V batteries. Replace the two batteries by inserting them into the remote control in accordance with the directions indicated.

- ① Open the battery cover on the back of the remote control.
- ② Insert the batteries with the + and – ends corresponding to the markings.
- ③ Close the battery cover.

⚠ CAUTION

The microphone is used solely for audio functionality and does not collect the user's sound.

Installation

| Mounting the Product to a Wall

Checking before mounting to a wall

You can mount this product onto a wall.

When affixing the product to the wall, follow the instructions below.

Please check the following first.

- It may be difficult to connect external devices and cables after wall-mounting. First, connect an external device with the proper connection cable to the product before mounting it to the wall.
- Please note the following when you mount the product to the wall. Product damage or injury may occur during the process.
 - Do not put objects on top of the wall-mounted product.
 - Secure the product firmly to the wall using the fixing screws so that it does not fall off.
 - Ensure it is out of the reach of children. Pulling or shaking the mounted product may cause it to fall.
- There are also speakers on the top of the product. When installing the product under the TV, install it 10 cm (3.9 inch) away from the bottom of the TV.
- When assembling, ensure that all of the provided screws are attached. If the screws are not fully tightened, the product may tilt or tip over, resulting in damage. Tightening the screws with excessive force may cause them to come off due to abrasion of the screw joint.
- Set the screw to the appropriate strength so that it does not wear out when using an electric driver.
- To install the bracket, make sure that the wall is made of a material that can sufficiently withstand the weight and vibration of the soundbar, such as concrete, natural stone, structural bricks or wood stud.

Components for mounting the product

Soundbar



Wall bracket

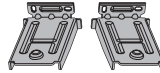

Soundbar screws



Wall bracket installation guide

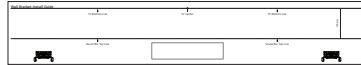

Sold separately

Bracket screws



Wall plugs



✔ Note

Screws and Wall Plugs are not supplied for mounting the product. We recommend the M4 x 35 mm bracket screws and the Hilti (HUD-1 6 x 30) wall plugs for the mounting.

Mounting the Product to a Wall

- 1 Find the wall bracket installation guide in the product package.
- 2 Align the “**TV Bottom Line**” on the wall bracket installation guide with the bottom of the TV, and attach it to the wall. Align the center of the wall-mounted TV with the part marked “**TV Center**” in the installation guide.

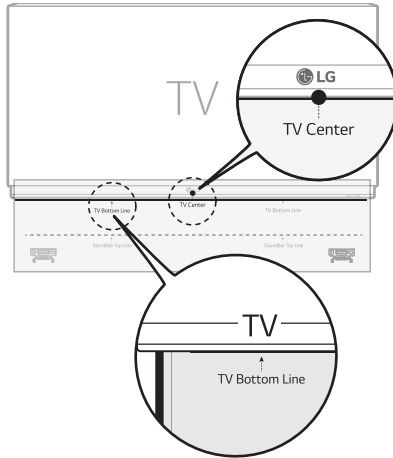

- 3 With a pen, mark screw holes on the installation guide where the wall brackets will be attached.

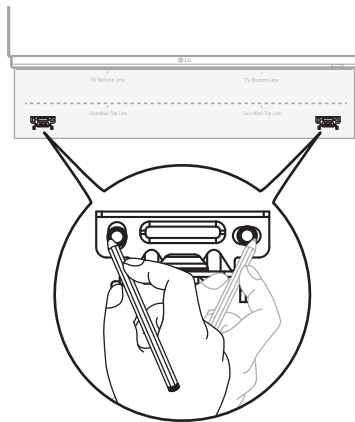

- 4 Drill screw holes in the marked positions on the installation guide.
- 5 Remove the wall bracket installation guide from the wall.

- 6** Fix the brackets firmly to the wall using the wall plugs and screws.

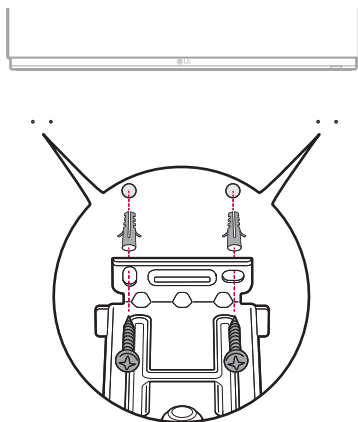

- 7** Place the product on the brackets. Position the product on the brackets so the screw holes on the bottom of the product align with the screw holes on the wall bracket.

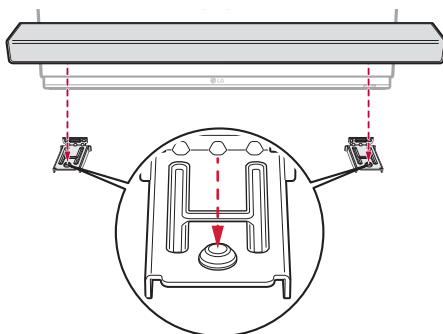

- 8** Firmly attach the product to the wall brackets using the screws provided.

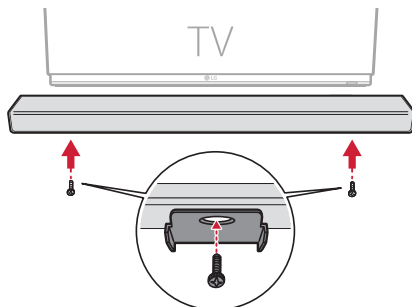

Connecting the power

- 1 Plug the power cable into the **AC IN** port on the rear of the product, then organize the cable.

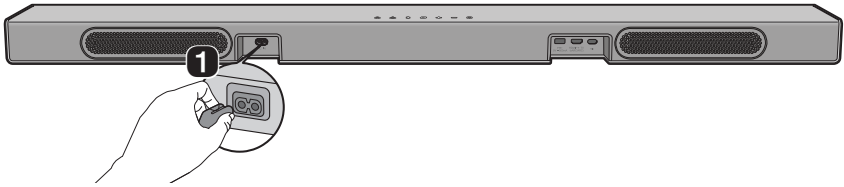

- 2 Plug the power cable connected to the product into an outlet. The power turns on automatically.

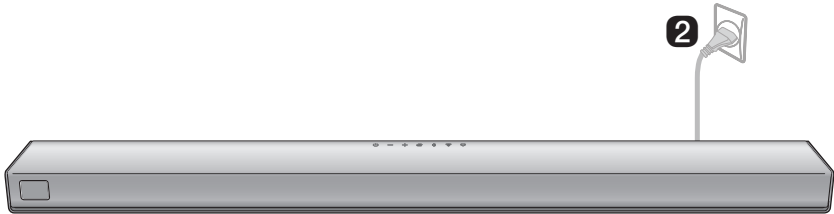

Connecting TV with an HDMI Cable

You can transmit TV audio to the product by connecting the TV to the product with an HDMI cable. Add a variety of 3D effects to the original audio to fill the room with a deep, rich sound.

Watching TV after connecting with an HDMI cable

- 1 Using the HDMI cable, connect the **HDMI™ ► TV (eARC / ARC)** terminal on the back of the product to the **HDMI IN (ARC)** terminal on the TV as shown in the picture.

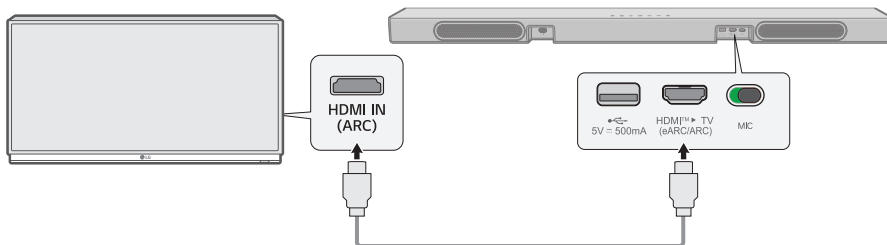

- 2 Press the **Source**  button repeatedly until [HDMI ARC] appears on the display window.



- 3 Enter the [Speaker] settings in the TV's menu and set the output to [HDMI ARC]. Settings and menu items may vary depending on the TV manufacturer.

✓ Note

- E-ARC supports high-quality audio such as Dolby TrueHD, and Dolby Atmos®.
- If you wish to use Dolby Atmos®, the connected device and its content should support Dolby Atmos®.
- Ensure that your TV supports the eARC function before you turn on eARC from the **Settings** menu. For more information on how to use this function, please refer to your TV's user manual. Settings may vary depending on the TV.
- If the Sound Mode Share function with HDMI ARC connection on your TV is activated, the remote control of the product may not work.
- Use a certified cable with the HDMI logo.

SIMPLINK

- SIMPLINK refers to the HDMI-CEC function that allows you to use a single TV remote control to easily operate an audio device or player connected to an LG TV via HDMI.
 - Functions controllable with a SIMPLINK-compatible LG TV remote control: Power on/off, volume control, mute on/off, etc.
- For more information on how to set up SIMPLINK, consult your LG TV's user manual.



✔ Note

- The SIMPLINK function may not work properly depending on the status of the product or other connected devices.
 - HDMI-CEC features by TV manufacturer: LG SIMPLINK, Sony BRAVIA Sync/Link, Philips EasyLink, Samsung Anynet+, etc.

Using WOW Orchestra with LG TV

The combination of the LG soundbar and the LG TV gives you the best listening experience to output sound simultaneously through both of them.

This function is automatically activated when the soundbar is connected to the TV and you can choose it on the sound out menu on the TV.

✔ Note

- Available on some LG TV and soundbar models.
- It operates according to the audio codec supported by the TV.
- Be sure to enable e-ARC on the TV.
- The messages displayed on the TV may differ depending on the model.
- Refer to the TV's instruction manual for more details on settings.
- Wow Orchestra is not available in Dolby Atmos FLEXCONNECT mode.

Using PSW mode with WOW Orchestra

PSW (Personalized Sound Wizard) mode is a personalized sound mode provided by LG TV and can be enjoyed in the WOW Orchestra function.

With the personalized sound mode provided by LG TV, the user-selected sound source is analyzed with artificial intelligence deep learning technology to set it as the preferred optimal sound.

The [PERSONALIZED SOUND] appears on the display window when PSW mode has set.



✔ Note

Refer to the TV's instruction manual for more details on settings.

Connecting TV via Bluetooth

Connect the product to a TV via **Bluetooth** and enjoy your TV audio in high quality.

Watching TV after connecting via Bluetooth

- 1 Press the **Bluetooth pair**  button on the product or remote control. The  blinks on the display window.



- 2 Press the **Settings** button on the TV remote control and enter the [Speaker] menu to set the output speaker to [**Bluetooth**].
- 3 Find and select "LG Sound Suite series model name".
- 4 When the product is connected to the TV via **Bluetooth**, the connected device name appears on the display window.

Connecting

Connecting with the product via LG ThinQ app

LG ThinQ app allows you to connect the product to the network and to control the product.

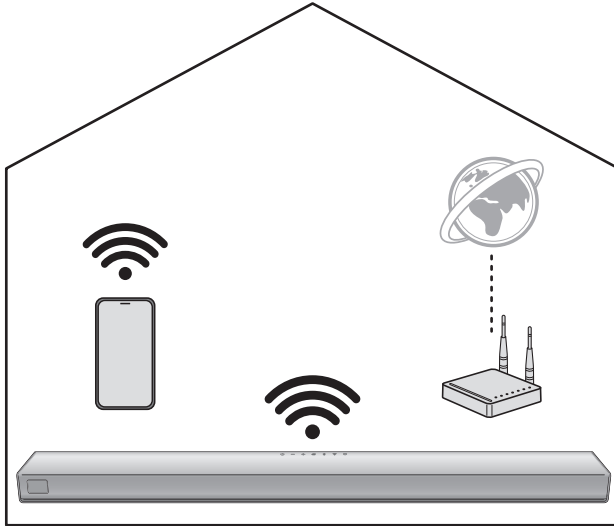

Please check the following first.

- Do you have a wireless router?
 - To connect your smartphone and the product via Wi-Fi, you must have a wireless router that is connected to the internet.
 - Make sure that they are both connected to the same Wi-Fi network.
 - If the wireless router signal is weak, it may not be able to connect. Move the router closer to the product or reposition it away from obstacles.
- Does your smartphone have **Bluetooth** enabled?
 - Enable **Bluetooth** on your smartphone.
 - If **Bluetooth** is enabled, you can easily connect to Wi-Fi. If **Bluetooth** is disabled, the product may not be registered on the **LG ThinQ app**.
- The **LG ThinQ app** is available in the versions listed below.
 - Android™ OS: Version 9.0 or higher
 - iOS OS: Version 16.0 or higher
 - Minimum supported versions for each OS may change later.

Installing the LG ThinQ app and registering the product

- 1 Go to the Google Play or the App Store on your smartphone and search for the **LG ThinQ app** to install it.
- 2 Run the **LG ThinQ app** and log in to the app with your account. If you don't have an account, you can also create a new one.
- 3 Press the **add (+)** button and follow the on-screen instructions in the **LG ThinQ app** to register your **Sound Suite** products.

✔ Note

- Settings menu items may vary depending on the smartphone manufacturer and OS.
 - Google, Android, Google Play, Google Home and Google Cast are trademarks of Google LLC.
 - If the router password contains some special characters (such as ` ' " + / \ ; : - _ ^ & () <>) or emoticons, the product may not be connected. It is recommended to set a password using a combination of English letters and numbers.
 - It is recommended to set the security type of the wireless router to WPA2.
-

Connecting via Bluetooth

You can play music files stored on a **Bluetooth** device, or run music apps to enjoy the music with this product.



Please check the following first.

- Steps to connect the device to the product may vary depending on the **Bluetooth** device type and model. For more information on how to connect the device, please refer to your external device's user manual.





Turn on the Bluetooth function on your phone

Select the **[Bluetooth]** from your smartphone's **Settings** menu.

Settings menu items may vary depending on your smartphone manufacturer and model.

- 1 Turn on the product.
- 2 Press the **Bluetooth pair**  button on the product or remote control. After a moment, the  blinks on the display window.



- 3 Tap the **Settings**  /  button on your smartphone and select **Bluetooth**.
- 4 Turn on the **Bluetooth** function. ( **Off** >  **On**)
- 5 You will see a list of connectable devices on your smartphone. Find and select "LG Sound Suite series model name".

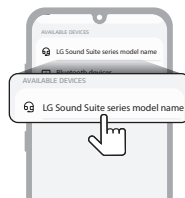

- 6 When the product is connected to the smartphone via **Bluetooth**, the connected device name appears on the display window.

- 7 If you cannot find the product "LG Sound Suite series model name", turn the **Bluetooth** off and turn it on again on your smartphone.
- 8 Run a Music app and listen to music on the smartphone.

✓ **Note**

- The closer the **Bluetooth** device is to the product, the better your connection.
 - If the product is not connected to a **Bluetooth** device, the lighting indicator blinks blue for 1 minute. Check the status of the **Bluetooth** device.
 - When using **Bluetooth**, you should adjust the volume level to an appropriate level.
-

Connecting to a USB Storage Device

Enjoy high-quality sound by connecting a USB storage device containing music files to the product.

Connecting the product to a USB storage device

- 1 Plug the USB storage device into the **USB** port on the back of the product.
 - The product cannot play any devices connected via a USB storage device hub or a USB storage device cable.
 - The product cannot be connected to any USB storage device, USB type MP3 player, or card reader that requires a separate device drive to be installed.

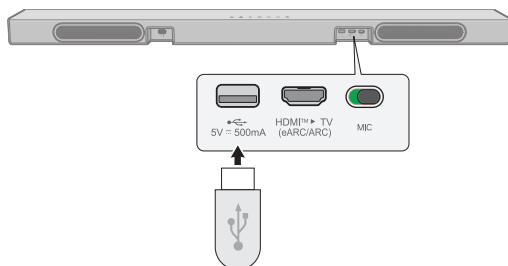

- 2 Press the **Source** button repeatedly until the USB icon appears on the display window.



- 3 Press the **Play/Pause** button on the remote control to enjoy the music.
 - When you press the **Play/Pause** button, the playback time appears on the display window.
 - Press the **Play/Pause** button while playing, playback paused.
 - **Up/Down**: This scrolls through the folders on the USB storage device. You can press the button to select the desired folder.
 - **Left/Right**: To play the previous song, press Left button. To play the next song, press Right button.

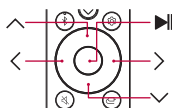

✔ **Note**

- It is recommended that you purchase a separate extension cable to make it easier to plug in and out USB storage devices.
- USB devices with a large storage volume may take several minutes to browse through files.
- LG Electronics is not responsible for any data loss. Please always back up the data on your USB storage device to minimize damage caused by data loss.
- Only FAT16/FAT32/NTFS formats are supported. exFAT format is not supported.
- Use the USB port of this product only for playing a media file. You cannot charge external devices with the USB port.

USB storage devices supported

- USB flash device

This product may not recognize some USB storage devices.

Playable file specifications

File extension	Sampling frequency / Bitrate
MP3	32 kHz - 48 kHz / 8 kbps - 320 kbps
AAC	32 kHz - 48 kHz / 8 kbps - 320 kbps
OGG	32 kHz - 48 kHz / 64 kbps - 320 kbps

File extension	Sampling frequency
FLAC (16 bit/24 bit)	32 kHz, 44.1 kHz, 48 kHz, 88.2 kHz, 96 kHz, 176.4 kHz, 192 kHz
WAV (16 bit/24 bit)	32 kHz, 44.1 kHz, 48 kHz, 88.2 kHz, 96 kHz, 176.4 kHz, 192 kHz

- Number of playable files: Up to 2,000
- Maximum number of directories: Up to 200
- This product cannot play files protected by DRM (Digital Rights Management).
- This product cannot play video files from a USB storage device.

Playback

Please check the following first.

- Be aware that some features, specifications, applications, services and/or content (“Features”) may not be available in some countries. The Features may vary by country and are subject to change without notice. The Features may not be available in some languages. Please refer to lg.com for service status by country.

| Works with Apple AirPlay

This product allow you to listen to the music from your iOS device through AirPlay.

✔ Note

- Make sure that this product and your iOS device are connected to the same Wi-Fi network.
- Make sure that your iOS device is running iOS 11.4 or later.
- The AirPlay 2-Enabled Speakers are needed to stream to multiple speakers.

Stream music through AirPlay

- 1 Open a music player app or the Control Center on your iOS device.
- 2 Tap AirPlay (📶).
- 3 Choose your product to listen to music. You can choose one or more AirPlay 2 -enabled speakers.



Apple®, AirPlay®, iPad®, iPad Air®, iPad Pro® and iPhone® are trademarks of Apple Inc., registered in the U.S. and other countries.

Use of the Works with Apple badge means that an accessory has been designed to work specifically with the technology identified in the badge and has been certified by the developer to meet Apple performance standards.

To control this AirPlay 2-enabled speaker, iOS 11.4 or later is required.

| Spotify Connect

Use your phone, tablet or computer as a remote control for Spotify. Go to spotify.com/connect to learn how.



The Spotify Software is subject to third party licenses found here: <https://www.spotify.com/connect/third-party-licenses>.

| Tidal Connect

Use your mobile or tablet as remote control for Tidal. Go to <https://tidal.com/connect> to learn how.



LG Radio+

You can listen to the radio and podcast via **LG ThinQ app**.

Use LG Radio+ selecting [Content] tab at the bottom of the **LG ThinQ app** screen.

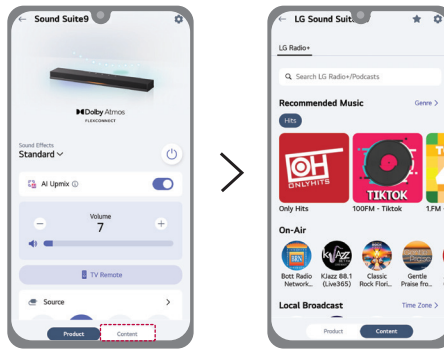

Various settings for convenience

Convenient functions

Auto Power

This function automatically turns the product on or off when the TV or external device is turned on or off.

When the connected device is turned on, the product turns on automatically and selects a function according to the input signal.

You can turn this function on or off by using the **LG ThinQ app**.

Night Time setting

This reduces the general sound volume, but raises the volume of soft and delicate sounds. This is useful when enjoying music or a movie late at night.

- 1 Press **Settings**  button repeatedly until [NIGHT TIME] appears on the display window.
- 2 Set the desired setting using **Up/Down** button on the remote control.

Option	Status
OFF - NIGHT TIME	The NIGHT TIME mode is turned off.
ON - NIGHT TIME	The NIGHT TIME mode is turned on.

Display window setting

The display window can be controlled as auto, off, and on.

- 1 Press **Settings**  button repeatedly until [DISPLAY] appears on the display window.
- 2 Set the desired setting using **Up/Down** button on the remote control.

Option	Status
AUTO - DISPLAY	Dimmed after 20 seconds of button input.
OFF - DISPLAY	Turned off after 20 seconds of button input.
ON - DISPLAY	Always on

Using Sound Follow

Sound Follow is a feature that uses UWB technology to detect the listener's position and shift the sweet spot accordingly.

- 1 Select the image with the speaker layout on **LG ThinQ app**.
- 2 Select [Set Position] in the Sound Follow feature area. Spatial audio is automatically optimized based on the current location where the user is holding the smartphone.

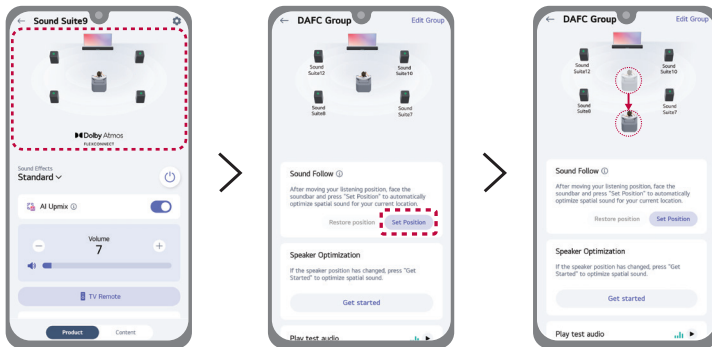

✓ Note

- To return to the default position set during Dolby Atmos FLEXCONNECT connection setup, select [Restore position] in the Sound Follow feature area.

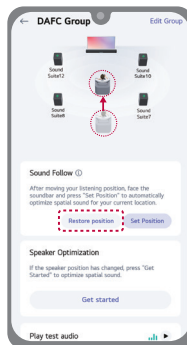

- The Sound Follow feature is available on smartphones equipped with UWB. (Refer to your smartphone manufacturer's manual for information on whether UWB is supported.)

Sound tuning

You can adjust the sound level of each speaker and sound tone.

- 1 Press **Settings** (ⓘ) button repeatedly until [WF] appears on the display window. It shows the current sound level.
- 2 Press **Left/Right** button to choose the speaker you want to adjust. (WF, C, *OVC, S, LOW, MID, HIG)
- 3 Press **Up/Down** button to adjust the sound level. The sound level for each speaker are displayed in the display window, and the lighting indicator is displayed as follows.

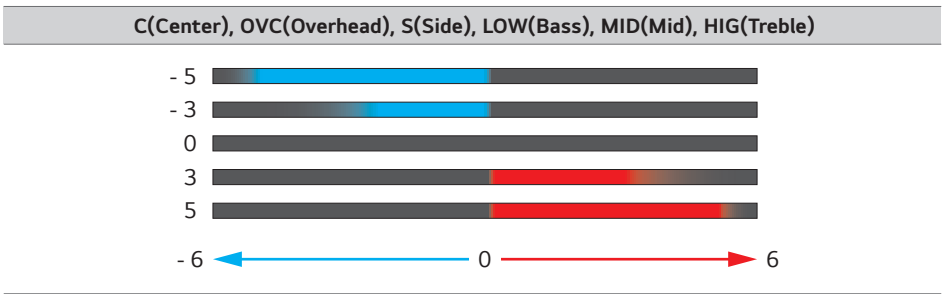
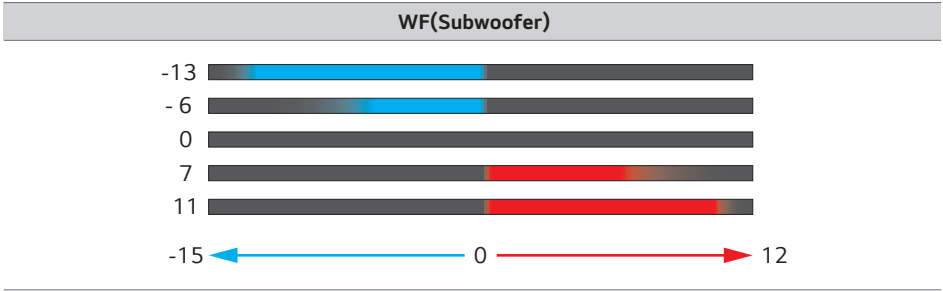

✓ Note

- If you press **Up/Down** button even when the level has reached the maximum or minimum, the lighting indicator will blink 3 times.
- When selecting Custom EQ, only WF, C, OVC, and S can be adjusted.
- You can adjust the subwoofer's trim level in the **LG ThinQ app**.
- *OVC (Overhead Virtual Channel): OVC creates virtual overhead sound without ceiling speakers, enhancing spatial immersion.



Using MY function

The **MY** function allows you to play your music quickly and easily.

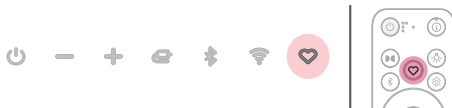
- 1 Set your **MY** function in the **LG ThinQ app**. Follow the instructions to set a playlist, volume level.
- 2 Press the **MY**  button on the product or the remote control.



Note

- To use the **MY** function, allow the media access permission.
 - The lighting indicator blinks white in the following cases:
 - If the **MY**  function is not set in the **LG ThinQ app**.
 - The **MY**  button may not function properly under the following conditions:
 - The device connected to the product is not connected to the network.
 - The music streaming service assigned to the **MY** function does not have an account.
 - Media access permissions have been disabled.
 - The **MY** function is not set in the **LG ThinQ app**.
-

Using Room Calibration Pro

This technology allows you to analyze the sound coming from the product and fine-tune the audio settings. Note that, when you start Room Calibration Pro, the product may make a louder sound than expected.

Please check the following first.

- If the microphone is turned off, the Room Calibration Pro feature cannot be used. Slide the **MIC (Microphone)** switch on the rear of the product to the ON position. (OFF > ON)
- The microphone is used solely for audio functionality and does not collect the user's sound.

Using Room Calibration Pro on the Product

- 1 Press the **MY** (♥) button twice on the product or the remote control.
- 2 The lighting indicator on the product displays dynamic, multicolored light animations and Room Calibration Pro automatically begins.
- 3 After a moment, the lighting indicator on the product displays multicolored lighting, and Room Calibration Pro is completed.

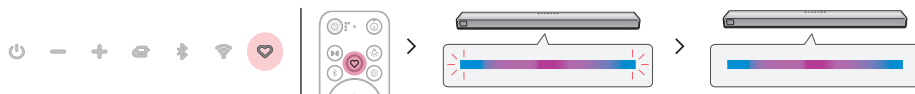

Using Room Calibration Pro in the LG ThinQ app

- 1 Select the **Settings**  button on **LG ThinQ app**.
- 2 Select [**Room Calibration Pro**] → [Start] and follow the on-screen instructions in the **LG ThinQ app**.

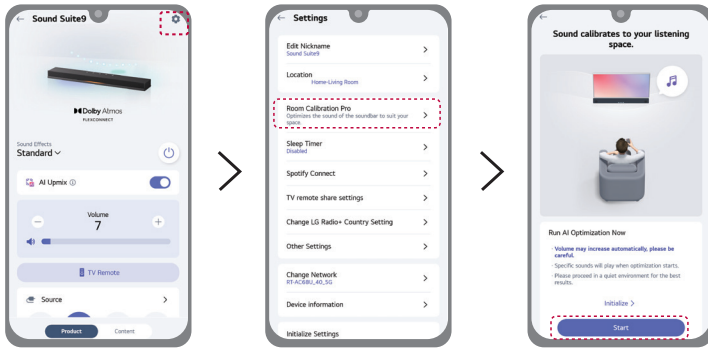

Using Sound Effects

Using various sound effects

You can select various sound effects by pressing the sound effect buttons on the remote control or by using the **LG ThinQ app**.

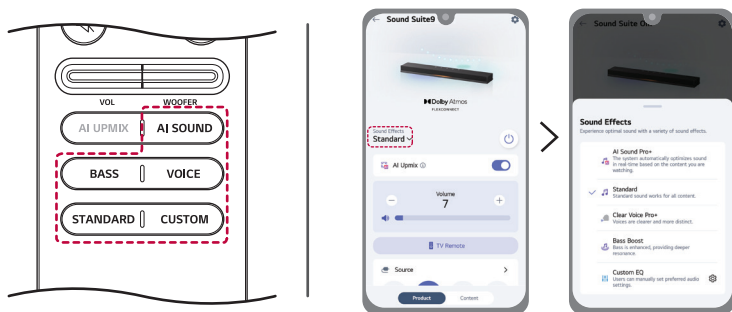

Button	Sound Effect	Discription
AI SOUND	AI Sound Pro+	Artificial intelligence selects the optimal sound settings to suit your content.
STANDARD	Standard	You can enjoy optimized sound.
VOICE	Clear Voice Pro+	Improves the clarity of voices.
BASS	Bass Boost	Bass sounds are enhanced.
CUSTOM	Custom EQ	Select the custom sound effect you set in the LG ThinQ app .

✓ Note

If your LG TV supports the PSW (Personal Sound Wizard) function, the PSW sound may be selected, and [PERSONALIZED SOUND] will appear on the display window. For detailed information on how to configure this feature, please refer to your TV's instruction manual.

Using AI UPMIX

The AI UPMIX is a technology that improves audio quality by adding virtual speaker channels. You can turn the function on or off using **AI UPMIX** button on the remote control or controlling on **LG ThinQ app**.

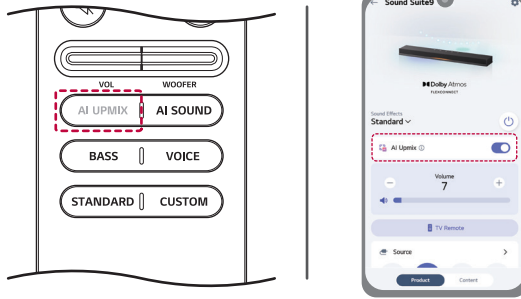

✔ Note

When the AI Sound Pro+ sound effect is in use, the AI Upmix feature cannot be disabled.

Speaker sound based on input channels

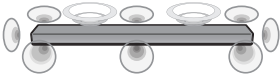
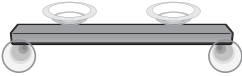
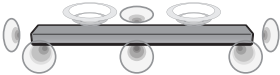
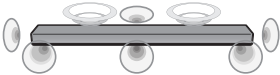
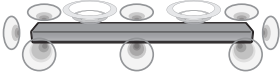
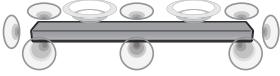
Sound Effects	Input	Output
AI Sound Pro+	2.0 channels	
	5.1 channels	
	7.1 channels or more	
	7.1.4 channels	
Standard Clear VoicePro+ Bass Boost CUSTOM	2.0 channels	
	5.1 channels	
	7.1 channels or more	
	7.1.4 channels	
	AI Upmix On mode	

Using Ambient lighting

Ambient lighting creates a more immersive atmosphere.

Using Ambient lighting on the Product

You can press the **Lighting**  button on the remote control repeatedly to turn ambient lighting on or off, and use the preset lighting. (→ See "Using Ambient lighting in the LG ThinQ app")

ON → LED1 → LED2 → LED3 → OFF

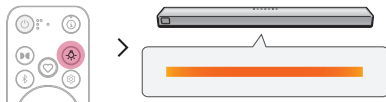

Using Ambient lighting in the LG ThinQ app

You can turn the ambient lighting on or off using the **LG ThinQ app**. After turning on ambient lighting, set the desired color and brightness.

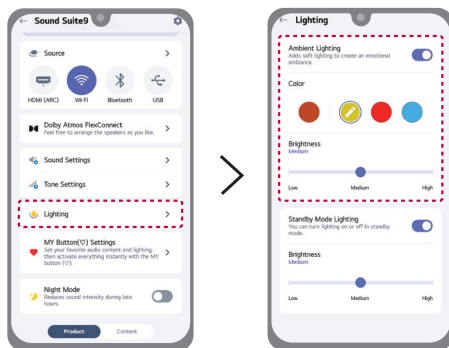

✓ Note

- The ambient lighting feature is available in all functions, regardless of music playback.
- The lighting indicator takes precedence over the ambient lighting.
- Do not look directly at the light-emitting part when the ambient lighting feature is turned on.
- If the illumination brightness is glaring, switch on the room lights or turn off the ambient lighting feature of the product.

Using Standby Mode lighting

You can turn the standby mode lighting on or off and adjust its brightness using the **LG ThinQ app**.

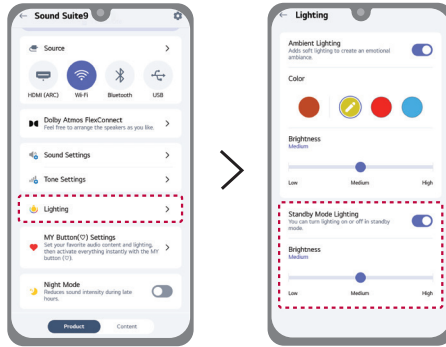

Resetting the Product

If the network connection is unstable, you will need to reset it. If the Wi-Fi network has been changed, you will need to reset the product and connect it to your smartphone again.

How to reset

- 1 Press and hold the **Wi-Fi**  button on the top of the product until [RESET] appears on the display window.
- 2 The lighting indicator blinks white, and all wireless network settings on the product will be cleared.

✔ Note

Once you reset the product, you will also need to reconnect the product to the smartphone via Wi-Fi on the **LG ThinQ app**.

How to deactivate the wireless network connection(s).

Press and hold the **Power**  button for 3 seconds or longer to turn off the product.

Using Dolby Atmos FLEXCONNECT

| About Dolby Atmos FLEXCONNECT

LG Sound Suite connection

This product can connect to other LG Sound Suite products to deliver optimal sound in any space or location. Without complicated wiring, you can enjoy optimal sound by connecting other LG Sound Suite products via the Dolby Atmos FLEXCONNECT settings in the **LG ThinQ app**.

Dolby Atmos FLEXCONNECT

Dolby Atmos FLEXCONNECT is designed to pair a TV or soundbar system with wireless speakers, delivering a richer and more immersive Dolby Atmos sound experience. It uses built-in microphones on the TV or soundbar to detect the position of connected wireless speakers and optimizes the sound to match the room's layout and speaker configuration.

Connect up to 3 or 4 LG Sound Suite speakers and a subwoofer to a Dolby Atmos FLEXCONNECT-compatible TV or soundbar to experience the ultimate Dolby Atmos sound. (→ See "Dolby Atmos FLEXCONNECT Connection Combinations")

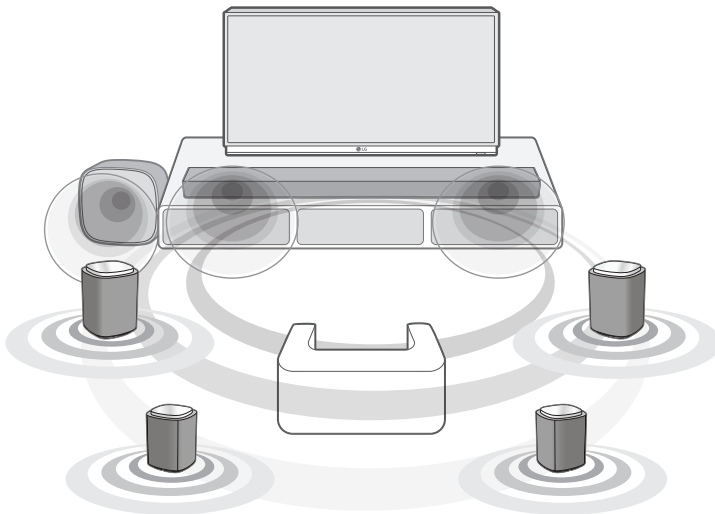

 **Dolby Atmos**
FLEXCONNECT

LG Sound Suite products

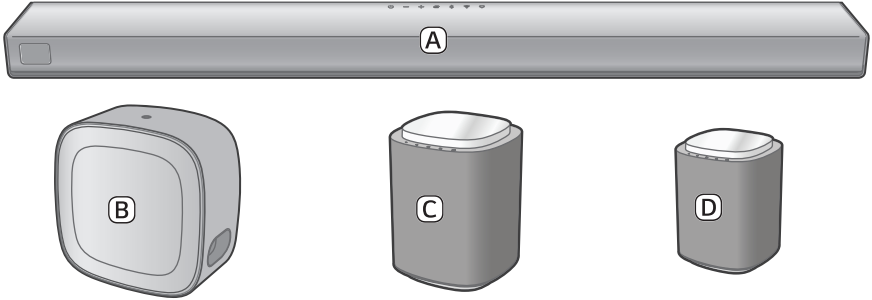

-
- A** Soundbar (LG Sound Suite H7)
 - B** Subwoofer (LG Sound Suite W7)
 - C** Speaker (LG Sound Suite M7)
 - D** Speaker (LG Sound Suite M5)

✔ Note

- LG Sound Suite products may be sold individually and may not contain all components shown. Some items may require separate purchase.
 - To enable the Dolby Atmos FLEXCONNECT connection, you must have the Dolby Atmos FLEXCONNECT-equipped LG TV or the LG Sound Suite soundbar, and meet one of the following conditions:
 - Use two or more M5 speakers. (Dolby Atmos FLEXCONNECT connection cannot be configured using a single M5 speaker.)
 - Use one or more M7 speakers.
 - Use one M5 speaker and one or more M7 speakers.
 - When setting up Dolby Atmos FLEXCONNECT with the H7 soundbar, use the HDMI cable to establish the e-ARC/ARC connection between the soundbar and the TV.
 - W7 requires a TV or soundbar with Dolby Atmos FLEXCONNECT support for connection.
 - After registering the soundbar in the **LG ThinQ app**, connect W7 through [Dolby Atmos FlexConnect] in the **LG ThinQ app**. (Refer to the W7 owner's manual for detailed connection instructions.)
 - W7 can be assigned to a Dolby Atmos FLEXCONNECT group, but does not operate in Dolby Atmos FLEXCONNECT mode.
 - A single W7 subwoofer can be connected to the TV or H7 soundbar via the Dolby Atmos FLEXCONNECT setting, but the Dolby Atmos FLEXCONNECT calibration function is not available.
 - The Dolby Atmos FLEXCONNECT calibration function does not automatically recognize the position of W7.
 - W7 position shown in the **LG ThinQ app** is for reference only and may differ from the actual installation location. This does not affect acoustic performance, so you can freely place it wherever you prefer.
 - Install the LG Sound Suite speakers and subwoofer at least 30 cm (11.8 inch) away from the TV or soundbar when connecting them.
 - To prevent wireless interference, maintain a distance of at least 1 m (3.3 ft) between the soundbar or the wireless subwoofer, wireless speakers and any peripheral devices that generate strong electromagnetic waves (ex. wireless routers, microwave ovens, etc.).
-

Dolby Atmos FLEXCONNECT Setup with Soundbar

Set the Dolby Atmos FLEXCONNECT by connecting your LG Sound Suite products in the **LG ThinQ app**.

Please check the following first.

- To set the Dolby Atmos FLEXCONNECT function, you need LG Sound Suite products.
- Dolby Atmos FLEXCONNECT-equipped products from other manufacturers are not compatible with LG Sound Suite products.
- Install and run the **LG ThinQ app** on your smartphone, then register your LG Sound Suite products.
- If the microphone on the soundbar is turned off, the Dolby Atmos FLEXCONNECT calibration feature cannot be used. Slide the **MIC (Microphone)** switch on the rear of the soundbar to the ON position. (OFF ON)
- The microphone is used solely for audio functionality and does not collect the user's sound.

- 1 Turn on all the LG Sound Suite products you want to use with the Dolby Atmos FLEXCONNECT feature.
- 2 In the **LG ThinQ app**, select the **Dolby Atmos FLEXCONNECT** feature.
- 3 Select [Edit Group].
- 4 A list of products that support Dolby Atmos FLEXCONNECT will appear. Select the product you want to connect and then select [Save].

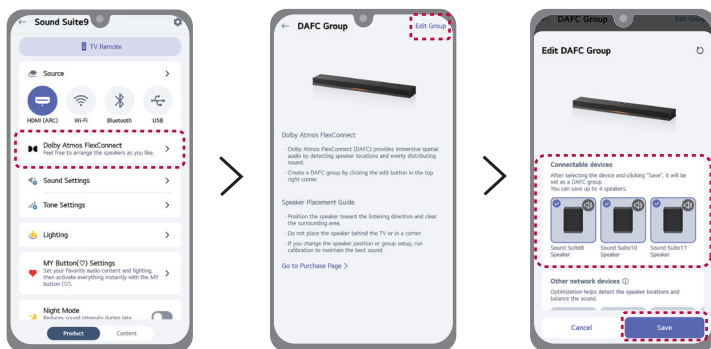

- 5 Set the distance between the LG Sound Suite soundbar and your listening position, then select [Next] and follow the instructions in the **LG ThinQ app**.

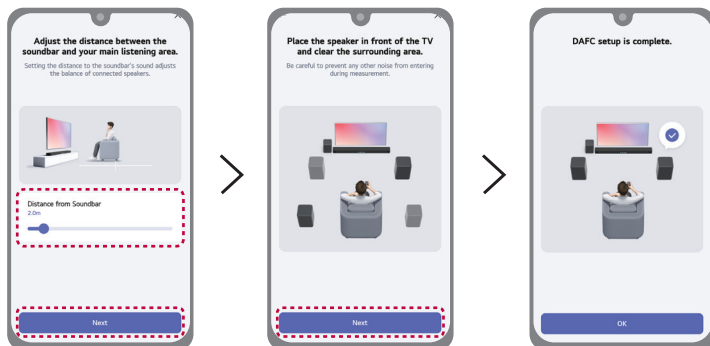

- 6 When the Dolby Atmos FLEXCONNECT connection is completed, the lighting indicator lights up white.

✓ **Note**

- For LG Sound Suite Speaker, only the **Power** (⏻) and **Source** (📺) buttons are available while using the Dolby Atmos FLEXCONNECT feature.
- When using the Dolby Atmos FLEXCONNECT feature, adjust the volume of your TV or soundbar as needed.
- When the speaker's Dolby Atmos FLEXCONNECT connection is unstable, the center of the lighting indicator lights up white. Check the Dolby Atmos FLEXCONNECT connection status.

Configuring Dolby Atmos FLEXCONNECT Group (Soundbar)

Run the **LG ThinQ app** on your smartphone. Select the image with the speaker layout, then select the [Edit Group]. Check or uncheck a product to group or ungroup it in the Dolby Atmos FLEXCONNECT settings, following the instructions in the **LG ThinQ app**.

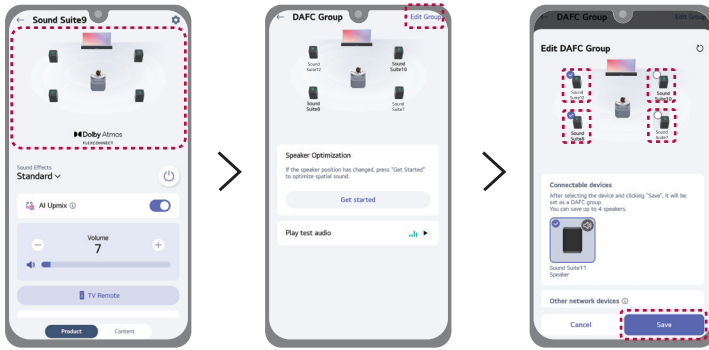

Reset Dolby Atmos FLEXCONNECT calibration (Soundbar)

When changing the speaker's position, reset the Dolby Atmos FLEXCONNECT calibration to ensure optimal sound performance.

Select the image with the speaker layout, then select the [Get started] in [Speaker Optimization] and follow the instructions in the **LG ThinQ app**.

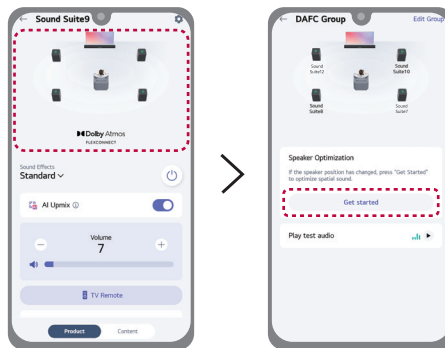

Dolby Atmos FLEXCONNECT Connection Combinations

Combinations with Soundbar

1 speaker with/without subwoofer

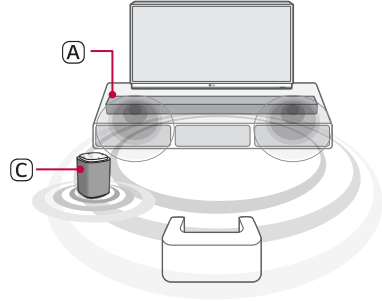
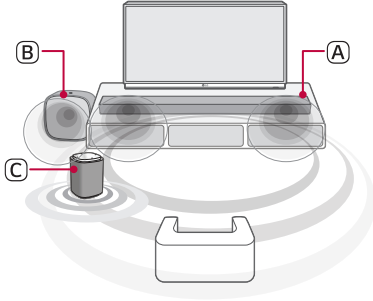

- (A) Soundbar (LG Sound Suite H7)
- (B) Subwoofer (LG Sound Suite W7)
- (C) Speaker (LG Sound Suite M7)

2 speakers with/without subwoofer

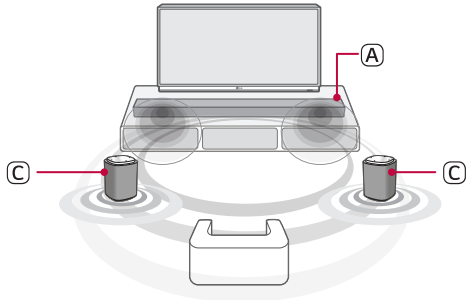
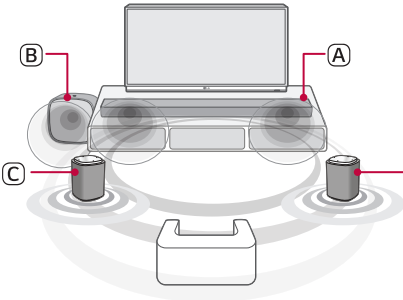

- (A) Soundbar (LG Sound Suite H7)
- (B) Subwoofer (LG Sound Suite W7)
- (C) Speakers (LG Sound Suite M7 or M5)

3 speakers with/without subwoofer

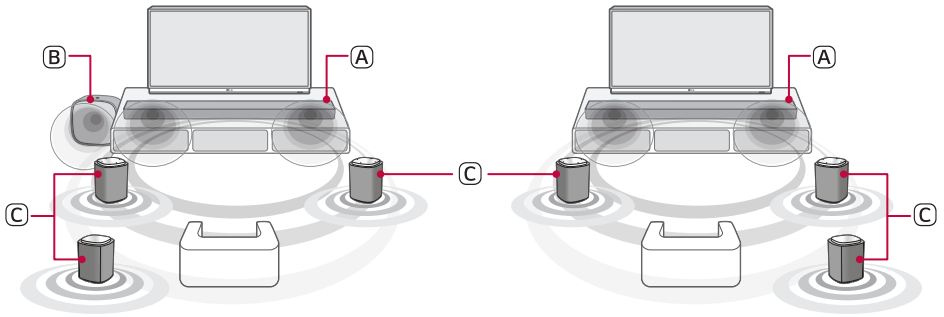

- (A) Soundbar (LG Sound Suite H7)
- (B) Subwoofer (LG Sound Suite W7)
- (C) Speakers (LG Sound Suite M7 or M5)

4 speakers with/without subwoofer

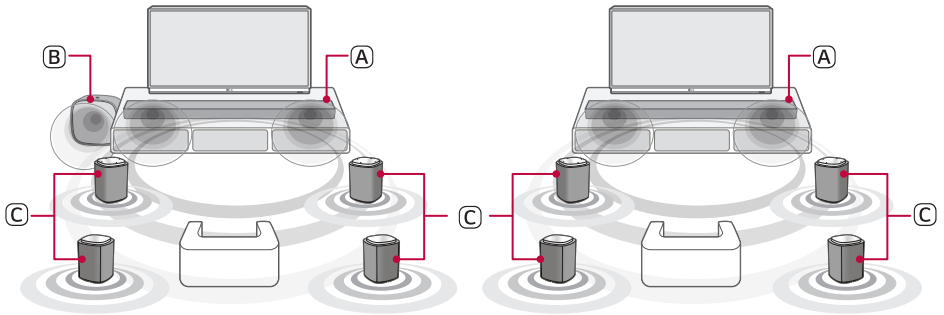

- (A) Soundbar (LG Sound Suite H7)
- (B) Subwoofer (LG Sound Suite W7)
- (C) Speakers (LG Sound Suite M7 or M5)

Safety Precautions

| Safety and Regulatory



CAUTION: TO REDUCE THE RISK OF ELECTRIC SHOCK DO NOT REMOVE COVER (OR BACK). NO USER-SERVICEABLE PARTS INSIDE. REFER SERVICING TO QUALIFIED SERVICE PERSONNEL.



This lightning flash with arrowhead symbol within an equilateral triangle is intended to alert the user to the presence of uninsulated dangerous voltage within the product's enclosure that may be of sufficient magnitude to constitute a risk of electric shock to persons.



The exclamation point within an equilateral triangle is intended to alert the user to the presence of important operating and maintenance (servicing) instructions in the literature accompanying the product.

WARNING:

- To prevent fire or electric shock hazard, do not expose this product to rain or moisture.
- Do not install this equipment in a confined space such as a book case or similar unit.

CAUTION:

- Do not use high voltage products around this product. (Ex. Electrical swatter) This product may malfunction due to electrical shock.
- No naked flame sources, such as lighted candles, should be placed on the apparatus.
- Do not block any ventilation openings. Install in accordance with the manufacturer's instructions. Slots and openings in the cabinet are provided for ventilation and to ensure reliable operation of the product and to protect it from over heating. The openings should never be blocked by placing the product on a bed, sofa, rug or other similar surface. This product shall not be placed in a built-in installation such as a bookcase or rack unless proper ventilation is provided or the manufacturer's instruction has been adhered to.
- The apparatus should not be exposed to water (dripping or splashing) and no objects filled with liquids, such as vases, should be placed on the apparatus.
- For safety marking information including product identification and supply ratings, please refer to the main label on the bottom or the other surface of the product.
- Be careful to make sure children do not put their hands or any objects into the *speaker duct.
 - * speaker duct: A hole for plentiful bass sound on speaker cabinet. (enclosure)

CAUTION concerning the Power Cord

Install this apparatus in a location where the power plug can be easily unplugged and plugged in. If there is a fire or problem with this apparatus, unplug it quickly.

Check the specification page of this owner's manual to be certain of the current requirements.

Do not overload wall outlets. Overloaded wall outlets, loose or damaged wall outlets, extension cords, frayed power cords, or damaged or cracked wire insulation are dangerous. Any of these conditions could result in electric shock or fire. Periodically examine the cord of your device, and if its appearance indicates damage or deterioration, unplug it, discontinue use of the device, and have the cord replaced with an exact replacement part by an authorized service center.

Protect the power cord from physical or mechanical abuse, such as being twisted, kinked, pinched, closed in a door, or walked upon. Pay particular attention to plugs, wall outlets, and the point where the cord exits the device.

For models using an adapter

Only use the AC adapter supplied with this device. Do not use a power supply from another device or another manufacturer. Using any other power cable or power supply may cause damage to the device and void your warranty.

For models using a battery

This device is equipped with a portable battery or accumulator.

CAUTION: Risk of fire or explosion if the battery is replaced by an incorrect type.

For models using a built-in battery

Do not store or transport at pressures lower than 11.6 kPa and at above 15,000 m altitude.

- no replacement of a battery with an incorrect type that can defeat a safeguard (for example, in the case of some lithium battery types), must be replaced with the same type battery by expert;
- no disposal of a battery into fire or a hot oven, or mechanically crushing or cutting of a battery, that can result in an explosion;
- no leaving a battery in an extremely high temperature surrounding environment that can result in an explosion or the leakage of flammable liquid or gas;
- do not subject battery to extremely low air pressure that may result in an explosion or the leakage of flammable liquid or gas.

Symbols

~ : Alternating current (AC).

≡ : Direct current (DC).

Ⓜ : This is a class II equipment.

⏻ : Standby power state.

⏻ : The power is turned on.

⚡ : Danger voltage.

Prevention of product misuse

To prevent misuse of the product, please be sure to check the contents below.

Precautions for installing the product

- Do not install the product in an unstable or vibrating place, such as on a shaking shelf or inclined surface. Install the product on a firm and level surface.
 - Otherwise, the product may fall or tip over and cause injury.
 - If you install the product on an unstable surface, the product may not work properly.
- If you install the product on a piece of furniture or shelf, make sure that the bottom front of the product does not protrude. Always use a piece of furniture or shelf that fits the product size.
 - Otherwise, the product may lose its balance and fall, causing injury or product damage.
- Install the product in a safe place. Otherwise, a child may bump into an edge of the product and get injured.
- Install the product in a place free from electromagnetic interference for proper operation.
- If you install the product in a place that does not meet the general use conditions, an unexpected quality problem may arise. So, make sure that you contact the service center first before installing the product in such a place.
- Do not keep the product in a place where the temperature is too high (above 40 °C (104 °F)) or too low (below 5 °C (41 °F)) or a place with too much humidity.
- Avoid places exposed to direct sunlight or heat, e.g., near a heater. Do not use or keep flammable sprays or substances near the product.
 - Otherwise, there is a risk of explosion or fire.
- Do not install the product in a place with too much moisture, dust or soot.
 - Otherwise, it may cause a fire or electric shock.
- Do not install the product in a narrow space, such as inside a bookshelf, that does not ventilate well. Do not cover the product with a table cover or curtain.
 - Otherwise, it may increase the product temperature, causing a breakdown or fire.
- Connect the power plug of the product to a power outlet that is easily accessible.
 - When a fire or other problem occurs in the product, you must be able to remove the power plug quickly.
- Do not connect multiple products to one power outlet at the same time.
 - Otherwise, it may cause overheating, resulting in a fire.

Precautions for using the product

- Do not lift or move the product while it is operating.
 - Otherwise, it may cause a breakdown.
- When moving the product, pull out the power cord and all cables connected to the product.
 - Otherwise, it may cause a fire or electric shock.
- Stop using the product immediately if you notice smoke or a strange odor. In this case, turn off the power immediately, disconnect the power plug, and contact the service center.
 - Using the product in this state may result in a fire or electric shock.
- Do not insert metal objects such as coins and hairpins or flammable objects such as paper and matchsticks into the product. Make sure that you tell any children not to do so.
 - Otherwise, it may cause a breakdown.
- If a foreign substance is inserted into the product, disconnect the power plug and contact the service center.
- Do not put a heavy object on top of the product.
 - Otherwise, it may tip over or fall, causing injury.
- Make sure that a child does not hang on the product or get on it.
 - Otherwise, the product may tip over or fall, causing injury. Make sure that you tell any children not to do so.
- Remove the power plug during thunderstorms.
 - Otherwise, it may cause a fire.
- Do not place vessels with liquid, such as a vase, pot, cosmetics, or medicine, on top of the product.
 - Otherwise, it may result in a fire, electric shock, or injury due to its fall, etc.
- Make sure that you connect the power plug firmly. Do not use voltage other than the rated voltage indicated on the product.
 - An insecure connection may result in a fire.
- Do not insert a conductor, such as chopsticks, into the groove on the other side of the product while the power plug is connected to an outlet. Do not touch the power plug immediately after unplugging it from the outlet.
 - Otherwise, it may cause electric shock.
- Hold the power plug with dry hands.
 - Otherwise, it may cause electric shock.
- Do not move or push the product while holding a product cable such as a power cord.
 - The cable may get damaged and cause a breakdown or result in a fire or electric shock.
- When removing a cable plugged into the product, make sure that you hold the connector at the end of the cable. Do not hold the cable line.
 - Otherwise, it may result in an injury or the product may fall and cause a breakdown.
- Do not keep the product in a place exposed to heat, e.g., near a heater.
 - Otherwise, it may cause a fire or malfunction.
- Do not disassemble, repair, or modify the product.
 - Otherwise, it may cause a breakdown, resulting in a fire, electric shock, or injury.
- Keep plastic wraps out of reach of toddlers.
 - Otherwise, toddlers may choke on the plastic wraps.
- Do not drop an object on the product or make an impact on it. Keep the product away from places with severe vibrations or magnets.

- Do not damage, modify, bend, twist, or heat a power cord.
 - Otherwise, it can damage the power cord, resulting in a fire or electric shock.
- When you are not using the product for a prolonged period, such as when you are away from home, unplug the power cord from the power outlet.
 - If dust accumulates, it can cause heat, resulting in electric shock or fire due to a short circuit.
- Do not dispose of waste batteries together with regular waste. Dispose of them separately.
 - Otherwise, there is a risk of explosion or fire.
- Do not use high voltage products around this product. (ex. Electrical swatter)
 - This product may malfunction due to electrical shock.
- Do not touch the power plug immediately after unplugging it from the outlet.
 - Otherwise, it may cause electric shock.
- Connect the power plug to a grounded outlet or extension cord. (This does not apply to products without a ground.)
 - Otherwise, it may cause a breakdown or electric shock due to a short circuit.
- In the case of a product with a vent, keeping the product turned on for a prolonged period can result in the vent getting hot. Do not touch the vent when it is hot. The heat is not a fault of the product and does not cause any malfunction. So, you may use the product without worry.
- Do not damage the power cable, AC adapter, or power plug. Do not place a heavy object on top of the power cable or AC adapter.
 - Otherwise, it may cause a fire or electric shock.
- If dust, dirt, etc. is found on the power plug pins, an AC adapter, or a power outlet, wipe it completely.
 - Otherwise, it may cause a fire.
- In the case of a product with a power cord or AC adapter, use only genuine power cords and AC adapters provided by LG Electronics.
 - Otherwise, it may cause a fire or electric shock.
- If you are using headphones or earphones, do not turn on the volume too loudly or use them for a prolonged period. [This only applies to models that support headphones or earphones]
 - Otherwise, it may negatively affect your hearing ability.
- The software of this product can be updated. Do not turn off the power of the product while updating the software. Once the update is complete, the product power turns off automatically.
 - If you turn off the power of the product while the software is being updated, it may cause a product malfunction.

The following only applies to models with a remote control

- Do not let children use the remote control. Keep the remote control out of reach of toddlers.
- Do not let children put the remote control in their mouth. Make sure that children don't swallow the remote control cover or a battery. If a child swallowed one, consult a physician immediately.
- Beware that children may step on the remote control cover and get injured.
- Remove obstacles between the product and the remote control for the smooth operation of the remote control.

The following only applies to models that use optical discs

- Do not insert your hand into a disc drive or pull it out forcefully.
- Make sure that children do not insert their hands into the disc drive.

The following only applies to models that able to watch video

- Refrain from watching a 3D video if you didn't have enough sleep or after drinking alcohol.
 - Some 3D videos may surprise or excite people.
- If any of the following symptoms occur while watching a video, stop watching it immediately and take a rest.
 - If any of the symptoms continue, consult a physician. Vertigo, burning sensation of eyes or face, unconscious motion, spasm, clouded consciousness, confusion, disorientation, nausea.
- You may suffer a symptom such as a seizure when you watch a certain image in a video or game or a video with a certain pattern or flashing lights. If you or any of your relatives have a history of epilepsy or seizures, consult a physician before watching.
- When you watch a 3D video, remove objects that are fragile or can cause injury from your surroundings.
 - If you mistake a 3D video as real or move your body with surprise, you or your nearby relatives may get injured or objects near you may get damaged.

Precautions for cleaning the product





- Do not spray water directly onto the product when cleaning it.
 - Otherwise, it may cause a fire or electric shock.
- When cleaning the product, make sure that you pull out the power cord first and wipe the surface of the product lightly with a dry cloth. Do not use chemicals or detergents when cleaning the product. They may deteriorate the product surface or peel off the paint from the product (benzene, alcohol, etc.).

Before Reporting Product Malfunction

Troubleshooting

If you experience the following issues while using the product, please perform several checks, as they may not be malfunctions.

General Errors

Issue	Solution
The product does not work properly	<ul style="list-style-type: none">• Unplug the power cables and any external devices such as your TV from the product, then plug them in again.• After resetting the product, connect your smartphone and Wi-Fi again. (→ See "Connecting with the product via LG ThinQ app") (Please beware that previous product settings may be lost.)
The power does not turn on	<ul style="list-style-type: none">• Is the power cord plugged into the outlet properly?<ul style="list-style-type: none">- Connect the power plug to the outlet correctly.
There is no sound	<ul style="list-style-type: none">• Is the volume set to minimum?<ul style="list-style-type: none">- Press the Volume   button on the remote control to turn up the volume.- If you are using an external device such as a Bluetooth device, adjust the volume of the external device.• Is the mute function activated?<ul style="list-style-type: none">- If "MUTE" displayed on the display window, the mute function is on. Press the Mute  button to unmute.• Is the correct product function selected according to the external device connected?<ul style="list-style-type: none">- Press the Source  button to check if you selected the correct function.
The remote control does not work properly	<ul style="list-style-type: none">• When using the remote control, point it at the front of the product.• Use the remote control within a 7-m (23 ft) radius of the product.• Replace the batteries with new ones as needed.
The Auto Power function does not work	<ul style="list-style-type: none">• Check connection to external devices (ex. Bluetooth device).

The product volume is low

- Check the following and change the settings accordingly.
 - Run the **LG ThinQ app**, tap the [Sound settings] on the first screen, and change the [DRC] function to [Off] on the [Sound output] menu.
 - When the product is connected to a TV, press the **Settings** button on the TV remote control, select the [Speaker] menu, and change the [Digital Sound Output] setting from [PCM] to [AUTO] or [BITSTREAM].
 - If the product's Night Time mode is on, turn it off by pressing the **Settings**  button and **Up/Down**.

The product fails to recognize a USB storage device

- The product may not support the file format of the USB storage device. Format the USB storage device and reconnect it. When formatting, refer to the USB storage device formats supported by the product and select an appropriate file format. (→ See "Connecting to a USB Storage Device")

A Bluetooth device cannot be paired

- Press the Settings button on the **Bluetooth** device and check whether the **Bluetooth** function is enabled. If **Bluetooth** is enabled, turn it off and on, then try again.
 - Remove any obstacles between the product and the **Bluetooth** device.
 - **Bluetooth** pairing (connection) may not work properly depending on the **Bluetooth** device type or the surrounding environment.
-

Network Connection Errors

Issue	Solution
The product cannot be connected to the LG ThinQ app	<ul style="list-style-type: none">• The connection may not be smooth when disturbed by other electric appliances that use radio waves, such as microwave ovens and medical equipment. Install the product 1 m (3.3 ft) away from other home appliances.• Turn off your wireless router and turn it on again.• Check if your smartphone's Wi-Fi function is turned on. You can check the Wi-Fi connection status in your smartphone's settings.• Check if the product and smartphone are on the same Wi-Fi network.
The product does not connect to the Wi-Fi network	<ul style="list-style-type: none">• Did you turn off the wireless router and turn it on again?<ul style="list-style-type: none">- Turn off the product and then turn it on again.• Have you installed a new wireless router?<ul style="list-style-type: none">- You will need to reconfigure the network settings of the product. (→ See "Connecting with the product via LG ThinQ app")• Did you change the settings of the wireless router?<ul style="list-style-type: none">- If the router password contains some special characters (such as ` ` " + / \ ; : - _ ^ & () < >) or emoticons, the product may not be connected. It is recommended to set a password using a combination of English letters and numbers.- It is recommended to set the security type of the wireless router to WPA2.• Unplug the router and plug it in after 10 seconds. Then try to connect after network recovery.• Changing the wireless channel on your router can help reduce wireless interference. (Here is how to change the wireless channel of the most common routers. For the exact details, refer to your router's instruction manual.)<ol style="list-style-type: none">① Enter the IP address on your smartphone, PC, or MAC, or use the setup wizard CD to log into the router setup page. This can only be done when the router is connected to the network via Wi-Fi or an Ethernet cable.② Find the wireless settings page and change the wireless channel of your 2.4 GHz / 5 GHz network. If the "Auto" channel is enabled, disable it and set up a specific channel.<ul style="list-style-type: none">- If the router channel is 2.4 GHz, 6 ch / 11 ch- If the router channel is 5 GHz, 48 ch / 149 ch③ Save the settings and restart the wireless router.<ul style="list-style-type: none">- Remove the power cable from the router, wait 5 seconds, and reconnect the power cable. When the router is completely powered on, try connecting it again.



App Errors

Issue	Solution
The app is not working properly	<ul style="list-style-type: none">• Do you get an error when running the app?<ul style="list-style-type: none">- Check if the power of the device is turned on.- Check if the app you wish to run supports the operating system of your smartphone. You can visit the app manufacturer's website to confirm supported operating systems.- Check if you have the latest version of the app. Search for the app on Google Play or the App Store and check if an Update button appears next to it. If it is not the latest version, tap the Update button.• If the error is not resolved yet, try connecting by using another smartphone with the LG ThinQ app installed.

Problems in Wireless Connection

Issue	Solution
There is radio interference	<ul style="list-style-type: none">• Do not install the product on metal furniture.• Wireless communication may not work properly in weak signal areas.
The Bluetooth connection is causing a malfunction or making noise	<ul style="list-style-type: none">• Do you hear noise or experience malfunctions when using Bluetooth?<ul style="list-style-type: none">- Do not let any part of your body contact the transceiver of the Bluetooth device or the product.- Do not install the Bluetooth device on a wall or in a secluded spot.- Remove any obstacles between the product and the Bluetooth device.- Install the Bluetooth device near the product.• When the Bluetooth device is too far from the product, Bluetooth may be disconnected or malfunctions may occur.<ul style="list-style-type: none">- Install the Bluetooth device 1 m (3.3 ft) away from devices that use the same frequency as the product, such as wireless routers, medical equipment, and microwave ovens.
Dolby Atmos FlexConnect are not working	<ul style="list-style-type: none">• LG Sound Suite products do not support DFS (Dynamic Frequency Selection) channels. Disable DFS channels on your router and try reconnecting. The method for disabling DFS channels may vary depending on the router manufacturer, so refer to your router's manual.

Turning off the Demo Mode

Issue	Solution
The remote control does not work	<ul style="list-style-type: none">• Does the functions unchanged, even if you press the Source  button several times?• Do you see "DEMO" repeatedly on the display window?<ul style="list-style-type: none">- The product may be in demo mode. To exit demo mode, press and hold the Source  button on the soundbar for about 10 seconds.- If "DEMO" still appears on the display window, press and hold the Wi-Fi  button on the soundbar for about 5 seconds.

Appendix

Specifications

General	
Power requirements	Refer to the main label.
Power Consumption	Refer to the main label.
Dimensions (W x H x D)	Approx. 1200.0 mm x 63.0 mm x 143.0 mm (including the base) (47.2 inch x 2.5 inch x 5.6 inch)
Operation Temperature Range	5 °C - 40 °C (41 °F to 104 °F)
Operation Humidity Range	5 % - 80 % RH
Bus Power Supply (USB)	5 V  500 mA
Available Digital Input Audio Sampling Frequency	32 kHz, 44.1 kHz, 48 kHz, 88.2 kHz, 96 kHz, 176.4 kHz, 192 kHz
Available Digital Input Audio format	Dolby Digital, Dobby Digital Plus, Dolby TrueHD, Dolby Atmos, PCM

Input/Output	
HDMI™ ► TV (eARC / ARC)	19-pin (Type A, HDMI™ connection terminal) × 1

System	
Wireless LAN (Internet antenna)	802.11a/b/g/n/ac/ax Wi-Fi network compatible

- Actual features, functionality, and other product specifications may differ and are subject to change without notice.

| Registered Trademarks and Licenses

All trademarks and trade names are the property of their respective owners.



Dolby, Dolby Atmos, and the double-D symbol are registered trademarks of Dolby Laboratories Licensing Corporation. Manufactured under license from Dolby Laboratories. Confidential unpublished works. Copyright © 2012–2024 Dolby Laboratories. All rights reserved.



The **Bluetooth**® word mark and logos are registered trademarks owned by the **Bluetooth** SIG, Inc. and any use of such marks by LG Electronics is under license.

Other trademarks and trade names are those of their respective owners.



The terms HDMI, HDMI High-Definition Multimedia Interface, HDMI Trade Dress and the HDMI Logos are trademarks or registered trademarks of HDMI Licensing Administrator, Inc.

| What You Need to Know about Network Services

All information, data, documents, correspondence, downloads, files, text, images, photos, graphics, videos, webcasts, publications, tools, resources, software, code, programs, applets, widgets, applications, products, and any other content ("Content") and services and offerings ("Services") made available by a third-party are provided under the sole responsibility of the service providers that produced them.

Withholding, removal, or suspension of any or all of these Content and Services are not restricted, and the use of and access to Contents and Services provided through LG Electronics products by the service providers may be changed anytime without prior notice.

If you have any demands or issues regarding Content and Services, you can refer to the service provider's website for the most up-to-date information. LG Electronics is not responsible for consumer services related to Content and Services, and does not undertake any obligations. Any questions or requirements regarding Content and Services should be fulfilled directly by the respective content and service providers.

It is clear that LG Electronics is not responsible for any Content or Services, or any change, removal, or suspension of each Content or Service, and does not certify or guarantee the use of or access to such Content or Services.

| Open Source Software Notice Information

To obtain the source code that is contained in this product, under GPL, LGPL, MPL, and other open source licenses that have the obligation to disclose source code, and to access all referred license terms, copyright notices and other relevant documents, please visit <https://opensource.lge.com>.

LG Electronics will also provide open source code to you on CD-ROM for a charge covering the cost of performing such distribution (such as the cost of media, shipping, and handling) upon email request to opensource@lge.com.

This offer is valid to anyone in receipt of this information for a period of three years after our last shipment of this product.

| Handling the Product

When shipping the Product

Please save the original shipping carton and packing materials. If you need to ship the product, for maximum protection, re-pack the product as it was originally packed at the factory.

Keeping the exterior surfaces clean

- Do not use volatile liquids such as insecticide spray near the product.
- Wiping with strong pressure may damage the surface.
- Do not leave rubber or plastic products in contact with the product for a long period of time.

Cleaning the product

To clean the product, use a soft, dry cloth. If the surfaces are extremely dirty, use a soft cloth lightly moistened with a mild detergent solution. Do not use strong solvents such as alcohol, benzine, or thinner, as these might damage the surface of the product.

