

User Guide

Lenovo
ThinkPad



Lenovo

ThinkPad E14 Gen 7 and ThinkPad E16 Gen 3

Read this first

Before using this documentation and the product it supports, ensure that you read and understand the following:

- *Safety and Warranty Guide*
- *Setup Guide*
- [Generic Safety and Compliance Notices](#)

Second Edition (June 2025)

© Copyright Lenovo 2025.

LIMITED AND RESTRICTED RIGHTS NOTICE: If data or software is delivered pursuant to a General Services Administration "GSA" contract, use, reproduction, or disclosure is subject to restrictions set forth in Contract No. GS-35F-05925.

Contents

Discover your Lenovo notebook.iv

Chapter 1. Meet your computer. 1

Front view	1
Side view	4
Bottom view	7
Features and specifications	9
USB specifications.	9

Chapter 2. Get started with your computer. 11

Set up your computer	11
Turn on the computer.	11
Complete the operating system setup	11
Access networks	12
Connect to Wi-Fi networks.	12
Connect to the wired Ethernet	12
Turn on Airplane mode	13
Interact with your computer	13
Use the keyboard shortcuts	13
Use the TrackPoint pointing device	14
Use the Trackpad	16
Use the touch screen (for selected models)	19
Connect to an external display	22

Chapter 3. Explore your computer 24

Lenovo apps	24
Lenovo Commercial Vantage.	24
Lenovo AI Now (for selected models).	24
Lenovo Smart Connect	25
Lenovo Smart Meeting	27
TrackPoint Quick Menu	28
Copilot in Windows	30
Intelligent Cooling	30
Switch among modes	31
Intelligent Cooling Boost (for AMD models only)	31
Cool and Quiet on Lap	31
Manage power	31
Check the battery status	31
Charge the computer with ac power	32
Maximize the life of the battery	32
Charge your computer with P-to-P 2.0 charging function	33
Change the power settings	33
Transfer data	33
Connect to a Bluetooth device	33

Chapter 4. Secure your computer and information. 35

Lock the computer	35
Log in with fingerprint recognition	35
Log in with facial recognition (for selected models)	36
Protect data against power loss	36
UEFI BIOS passwords	37
Password types	37
Set, change, or remove a password	38
Associate your fingerprints with passwords (for selected models)	39
FIDO (Fast Identity Online) authentication	40
Register FIDO2 USB device in ThinkShield Passwordless Power-On Device Manager.	40
Log in to the System with Passwordless Power-On Authentication	40

Chapter 5. Configure advanced settings. 41

UEFI BIOS	41
Enter the UEFI BIOS menu.	41
Navigate the UEFI BIOS menu	41
Customize BIOS Defaults	41
Detect memory retraining (for Intel models only)	42

Chapter 6. Frequently asked questions. 43

Camera problems	43
Audio problems.	43
Mouse problems	44
Keyboard problems	45
My keyboard does not work	45
My keyboard backlight does not work	46
Battery problems	46
My computer battery discharges quickly	46
My computer battery icon disappears	47
My computer battery is not recognized	47
Battery calibration issues	47
My computer has no power	48
Display problems	49
Blue screen	49
Black screen	49
Screen flickering.	49
The external display does not work	50
The display remains dim.	51
Customize my display settings	51

Set my computer's screen resolution	51
Fingerprint reader problems	52
Fingerprint recognition cannot be set up	52
Fingerprint recognition error	53
Fingerprint enrollment error	54
Touchpad or trackpad problems	54
My touchpad or trackpad does not respond	54
My touchpad or trackpad responds slowly	55
TrackPoint problems	55
Touch screen problems	56
Fan problems	57
Loud fan noise	57
Computer overheating	57
My computer fan runs constantly	58
External devices problems	58
Docking station problems	59
Poor docking station connection	59
My docking station is well connected but does not work	59
Hinge problems	60
My computer hinges lose torque	60
My computer cannot be opened or closed	60
Pen problems	60
USB problems	61
My USB connector does not work	61
Recover data from a USB drive	61
Create a recovery drive	62
Copilot key problems	62
Bluetooth connection problems	63
Network connection problems	64
Power charging problems	65
My computer is not charged when connected to ac power	65
My built-in battery cannot be charged	66
My built-in battery is not fully charged	66
Startup problems	66
My computer does not start up	66
My computer starts up slowly	67
My computer does not shut down	67
My computer gets stuck in sleep or hibernate mode	68
The power button does not work	69
Windows login error	69
Blue screen during the startup	69
“no bootable device” error	70
Enable or disable secure boot	70
My computer cannot boot from a USB drive	70
Performance problems	71
My computer does not work	71
My computer responds slowly	72

Beeping problems	72
Security problems	73
Password problems	74
Change my Windows password	74
Reset my Windows password	74
Retrieve my BitLocker recovery key in Windows	74
OS problems	75
Install the Windows operating system	75
Windows operating system installation error	76
Upgrade my Windows operating system	76
Windows operating system upgrading error	77
Recover Windows operating system	77
Windows operating system recovery error	78
Driver problems	79
Update or install the latest device driver	79
Driver installation error	80
UEFI BIOS problems	81
Update the UEFI BIOS	81
UEFI BIOS update error	81
Recover the UEFI BIOS	81
Reset system to factory defaults	82
Storage device problems	82
My solid-state drive is not detected	82
External storage device is not recognized	83
Storage device read/write error	84
Recovery problems	84
Recover deleted files on my computer	84
Recover my computer	85
Self-help resource	85
Chapter 7. Help and support	88
Error messages	88
Battery-charge LED indicator diagnosis	88
Diagnostics tool	90
Troubleshoot and diagnose at Lenovo Support Web site	90
Hardware scan	91
UEFI Diagnostics tool	91
Lenovo Memory Self Repair (for Intel models only)	92
Windows label	92
Call Lenovo	93
Before you contact Lenovo	93
Find your service QR code and serial number	93
Lenovo Customer Support Center	94
Chapter 8. CRU replacement	96
What are CRUs	96
CRU list	96

Before you replace any CRU	96
Disable Fast Startup	97
Disable the built-in battery	97
Replace a CRU	97
Base cover assembly	97
Memory module	99
M.2 solid-state drive and M.2 solid-state drive bracket	100
Built-in battery	102
Speaker assembly	104

Appendix A. Compliance information.106
--	-------------

Appendix B. Accessibility features109
---	-------------

Appendix C. Notice for USB connector name update110
---	-------------

Appendix D. Notices and trademarks.111
--	-------------

Discover your Lenovo notebook

Thank you for choosing a Lenovo® notebook! We are dedicated to delivering the best solution to you.

Before starting your tour, please read the following information:

- Illustrations in this documentation might look different from your product.
- Depending on the model, some optional accessories, features, software programs, and user interface instructions might not be applicable to your computer.
- Documentation content is subject to change without notice. To get the latest documentation, go to <https://pcsupport.lenovo.com>.

Chapter 1. Meet your computer





This chapter introduces the appearance, features and specifications of your computer.





Front view

Have a quick glance at the front view of your computer.

ThinkPad E14 Gen 7











Item	Description	Item	Description
	Microphone		Infrared camera / Camera
	Webcam privacy shutter		Touch screen*

Item	Description	Item	Description
	Power button with fingerprint reader*		TrackPoint® pointing stick
	Speaker		TrackPoint Three Buttons
	Trackpad		

* for selected models

ThinkPad E16 Gen 3



Item	Description	Item	Description
	Microphone		Infrared camera / Camera
	Webcam privacy shutter		Touch screen*
	Power button with fingerprint reader*		TrackPoint® pointing stick
	TrackPoint Three Buttons		Trackpad



Webcam privacy shutter

Slide the webcam privacy shutter to cover or uncover the camera lens. It is designed to protect your privacy.

Important information

Your computer contains magnets. Keep a safe distance away from devices and objects that might be affected by magnets, such as credit cards.

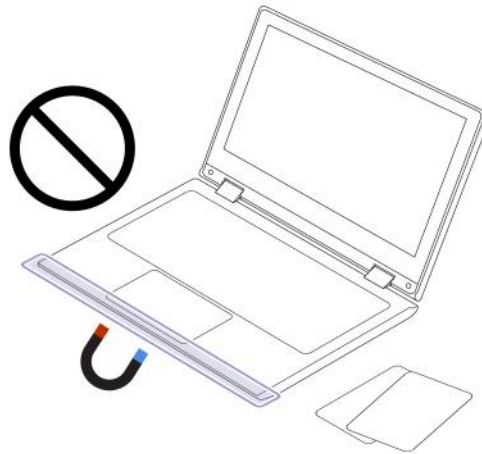

Related topics





- “Use the TrackPoint pointing device” on page 14
- “Use the Trackpad” on page 16
- “Use the touch screen (for selected models)” on page 19
- “Log in with fingerprint recognition (for selected models)” on page 35
- “Log in with facial recognition (for selected models)” on page 36

Side view

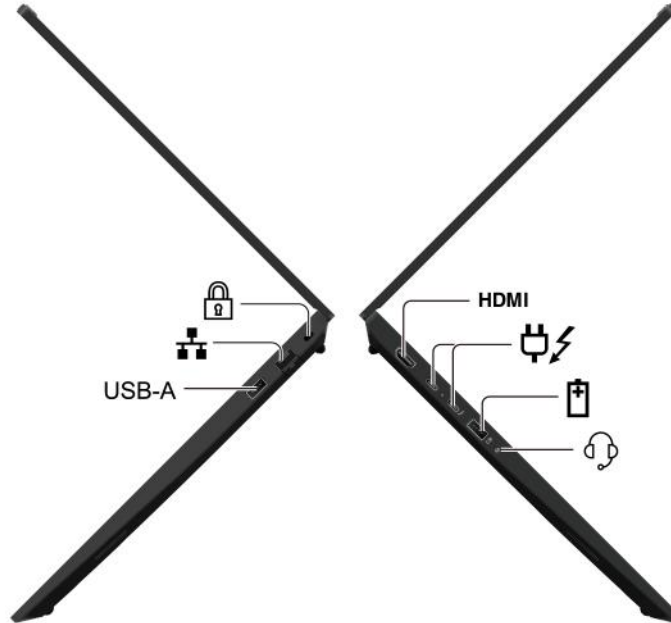
Have a quick glance at ports on both sides of your computer.







Intel Lunar Lake models

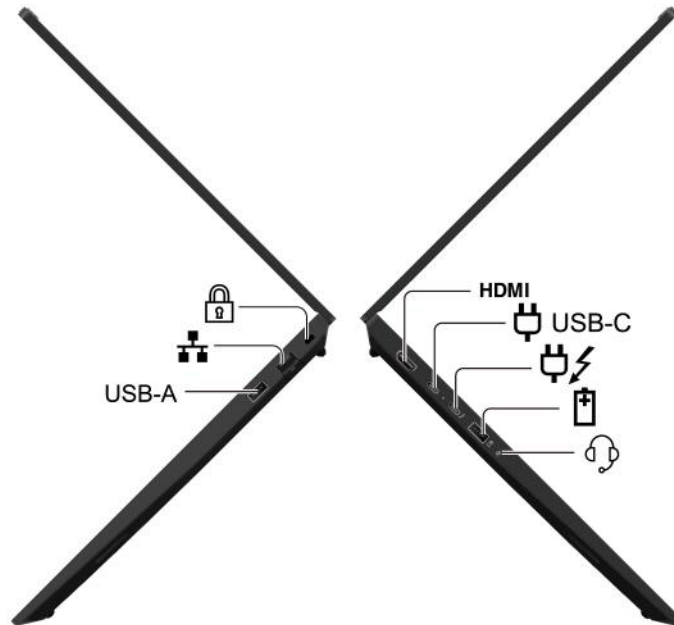

Item	Description	Item	Description
	Security slot	HDMI	HDMI™ connector
	Ethernet connector		USB-C power connector (Thunderbolt™ 4)
USB-A	USB-A connector (USB 5Gbps)		USB-A connector (USB 10Gbps, Always On USB)
			Audio connector







Intel Arrow Lake models and Intel Raptor Lake Refresh models

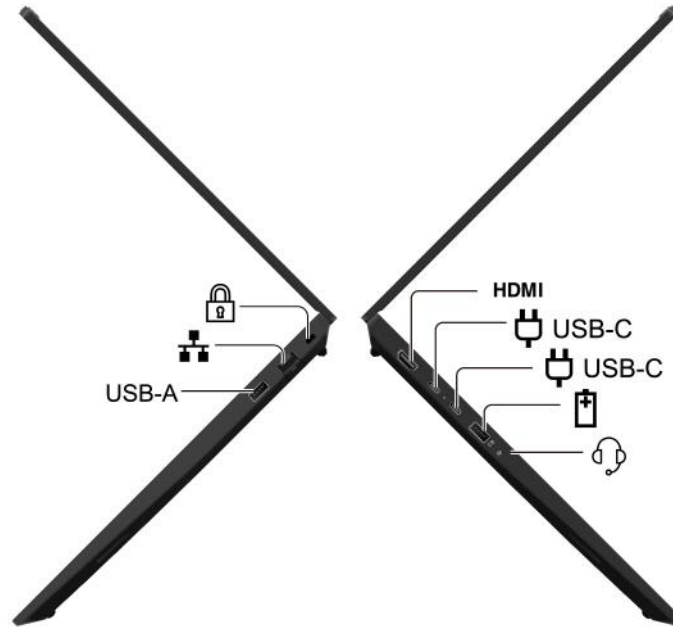

Item	Description	Item	Description
	Security slot	HDMI	HDMI™ connector
	Ethernet connector	 USB-C	USB-C® power connector (USB 20Gbps)
USB-A	USB-A connector (USB 5Gbps)		USB-C power connector (Thunderbolt™ 4)
			USB-A connector (USB 10Gbps, Always On USB)
			Audio connector

AMD models



Item	Description	Item	Description
	Security slot	HDMI	HDMI™ connector
	Ethernet connector	 USB-C	USB-C power connector (USB 5Gbps)
USB-A	USB-A connector (USB 5Gbps)	 USB-C	USB-C power connector (USB4 40Gbps)
			USB-A connector (USB 10Gbps, Always On USB)
			Audio connector

Note: For more information about the USB connector name update, see Appendix C “Notice for USB connector name update” on page 110.

Statement on USB transfer rate

Depending on many factors such as the processing capability of the host and peripheral devices, file attributes, and other factors related to system configuration and operating environments, the actual transfer rate using the various USB connectors on this device will vary and will be slower than the data rate listed in the connector name or below for each corresponding device.

USB device	Data rate (Gbps)
Thunderbolt 3	40
Thunderbolt 4	40

Related topics

- “Charge the computer with ac power” on page 32
- “USB specifications” on page 9
- “Lock the computer” on page 35

Bottom view

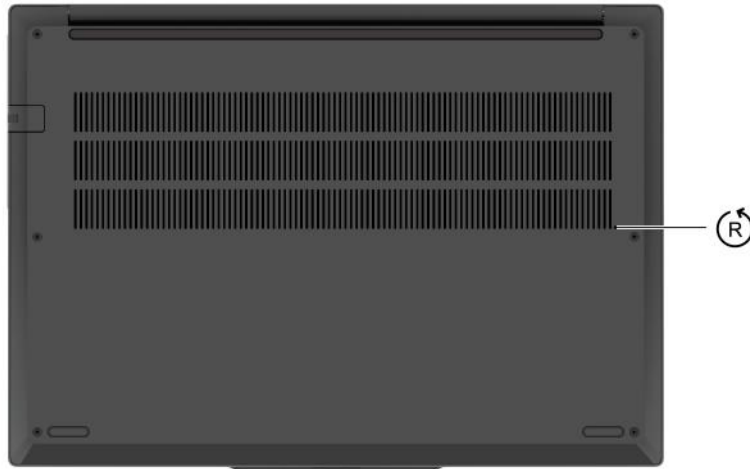

Have a quick glance at the bottom part of your computer.

ThinkPad E14 Gen 7

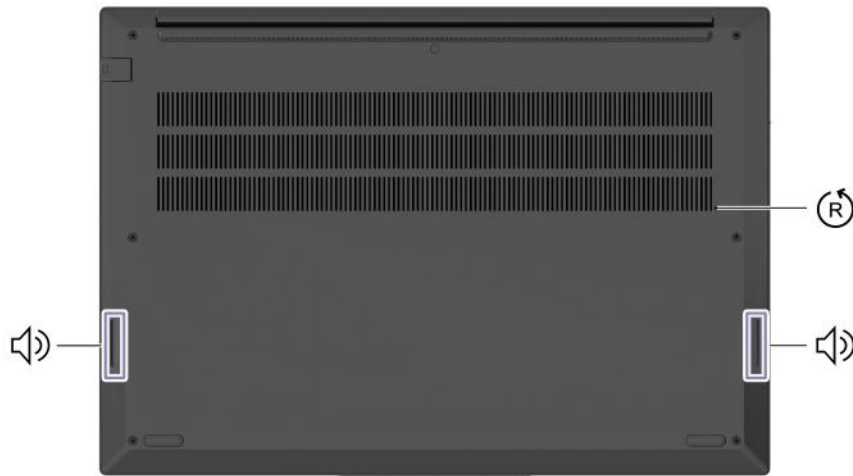

ThinkPad E16 Gen 3



Item	Description	Item	Description
	Emergency-reset hole		Speaker

Emergency-reset hole can help you to recover computer when the computer stops responding and you cannot turn it off by pressing the power button. Do the following to reset your computer:

Step 1. Disconnect your computer from ac power.

Step 2. Insert a straightened paper clip into the hole to cut off power supply temporarily.

Step 3. Connect your computer to ac power and then turn on your computer.

If your computer is still no response, you can call Lenovo Customer Support Center to get further help.

CAUTION:

When the computer is operating, it should be placed on a hard and flat surface with its bottom area not in contact with user's bare skin. Under normal operating conditions, the temperature of the bottom surface will remain within an acceptable range as defined in *IEC 62368-1*, but such temperatures can still be high enough to cause discomfort or harm to the user if directly touched for over one minute at a time. As such, it is recommended that users avoid prolonged direct contact with the bottom of the computer.

Note: Some Lenovo computers include a display that can be rotated 360 degrees. When those products are used as a tablet computer, the temperatures of all the accessible parts are within an acceptable range as defined in *IEC 62368-1*.

Features and specifications

Get to know more hardware and software details of your computer.

Specification	Description
Memory	Double Data Rate 5 (DDR5) Small Outline Dual Inline Memory Module (SODIMM), up to 32 GB of each, up to 64GB in total
Storage device	Dual slots, 2242 or 2280 M.2 solid-state drive, up to 1 TB of each, up to 2 TB in total
Audio	<ul style="list-style-type: none">• Dolby Atmos®• Audio by Harman®
Display	<ul style="list-style-type: none">• Color display with In-Plane Switching (IPS) technology• Display ratio: 16:10• Display resolution:<ul style="list-style-type: none">– ThinkPad E14 Gen 7:<ul style="list-style-type: none">– 2880 x 1800 pixels– 1920 x 1200 pixels– ThinkPad E16 Gen 3:<ul style="list-style-type: none">– 2560 x 1600 pixels– 1920 x 1200 pixels• Multi-touch technology*
Security features	<ul style="list-style-type: none">• Face authentication*• Fingerprint reader* (integrated in power button)• Trusted Platform Module (TPM)*
Wireless features	<ul style="list-style-type: none">• Bluetooth• Wireless LAN

* for selected models

USB specifications

Get to know more USB specifications.

Note: Depending on the model, some USB connectors might not be available on your computer.

Connector name	Description
----------------	-------------

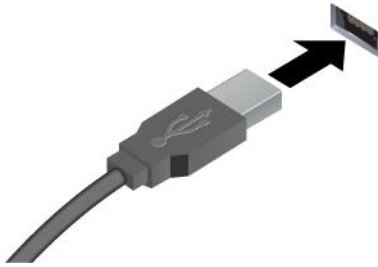

Connect USB-compatible devices, such as a USB keyboard, USB mouse, USB storage device, or USB printer.

- USB-A connector (Hi-Speed USB)
- USB-A connector (USB 5Gbps)
- USB-A connector (USB 10Gbps)

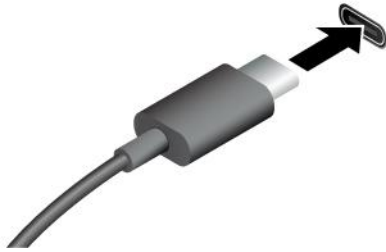

- Charge USB-C compatible devices with the output voltage and current of 5 V and 3 A.
- Connect to an external display:
 - USB-C to VGA: up to 1920 x 1080 pixels, 60 Hz
 - USB-C to DP: up to 7680 x 4320 pixels, 60 Hz
- Connect to USB-C accessories to help expand your computer functionality. To purchase USB-C accessories, go to <https://www.lenovo.com/accessories>.

- USB-C connector (USB 5Gbps)
- USB-C connector (USB 10Gbps)
- USB-C connector (Thunderbolt 3)
- USB-C connector (Thunderbolt 4)
- USB-C connector (USB4 40Gbps)
- USB-C connector (DP Alt mode DP 2.1)

Chapter 2. Get started with your computer

This chapter introduces the instructions of setting up your computer, various ways to connect to networks, and to interact with your computer.

Set up your computer

This section helps you to set up your computer and get it ready for use.

Turn on the computer

Follow the instructions to turn on your computer.

- Step 1. Connect the power cord to the ac power adapter.
- Step 2. Connect the power adapter to your computer.
- Step 3. Plug the power cord into the ac power.
- Step 4. Press the power button to turn on your computer.

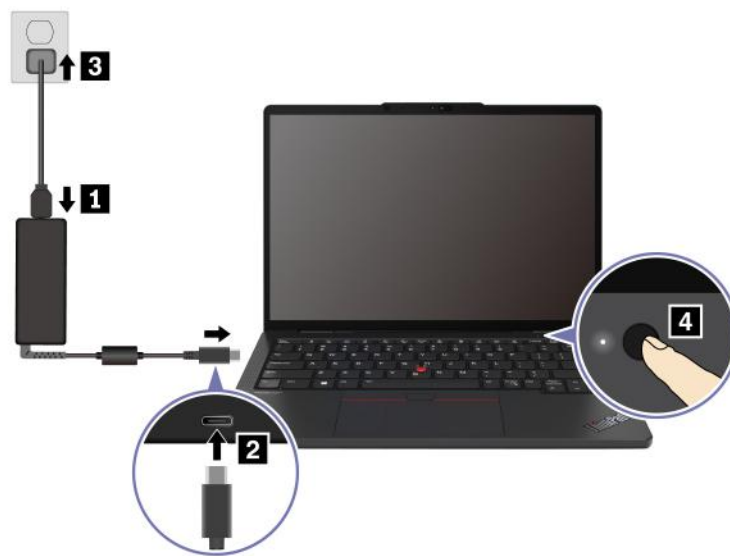

Notes:

- The appearance varies depending on the computer model.
- It is recommended to fully charge the computer when using it for the first time. Click the battery status icon at the bottom right of your desktop to check the battery status.

Related topics

- “Check the battery status” on page 31
- “Charge the computer with ac power” on page 32

Complete the operating system setup

Before exploring your computer, you need to complete the operating system setup. The setup includes but is not limited to:

- Select the country or region.
- Connect to an available network.
- Accept the license agreement.
- Create a Microsoft account or log in with your Microsoft account.
- Set up your password, fingerprint, or facial recognition as preferred.
- Customize your experience.

Notes:

- Depending on the model, some settings might not be available on your computer.
- Do not turn off your computer and ensure it is connected to the ac power during the whole process.

Follow the instructions to set up the operating system.

Step 1. Connect the computer to the ac power and turn it on.

Step 2. Follow the on-screen instructions to complete the operating system setup.

Related topics

- “Log in with your fingerprint” on page 35
- “Log in with facial recognition (for selected models)” on page 36
- “Set, change, or remove a password” on page 38

Access networks

This section helps you connect to a wireless or wired network.

Connect to Wi-Fi networks

Click the network icon  on the bottom right of your display to connect to an available network. Provide required information, if needed.

Note: The wireless LAN module on your computer might support different standards. For some countries or regions, use of 802.11ax/be and/or 6 GHz frequency band might be disabled according to local regulations.

Connect to the wired Ethernet

Connect your computer to a local network through the Ethernet connector on your computer with an Ethernet cable.



Turn on Airplane mode

You might need to turn on Airplane mode if you board an airplane. When Airplane mode is on, all wireless features are turned off automatically. Click the network icon  on the bottom right of your display to turn on Airplane mode.

Note: You can enable Wi-Fi networks in this mode according to your actual needs.

Interact with your computer











Explore various ways to interact with your computer.

Use the keyboard shortcuts





Keyboard shortcuts are keys or combinations of keys that provide a quick way to perform particular functions. They help you work more efficiently.

The following tables introduce the functions of keyboard shortcuts.

FnLock and function keys

Key / Key combination	Function description
	Switch between the special and standard functions of the function keys (F1–F12).
Fn+FnLock	Function keys provide two sets of functions: special function and standard function. Icons on the key denote the special function, such as  and  . Characters on the key denote the standard function, such as F1 and F2. LED indicator on Esc key indicates which function of the function keys is enabled: <ul style="list-style-type: none">• When the indicator is off, the special function is enabled.• When the indicator is on, the standard function is enabled.
	Mute / Unmute (Speakers).
	Decrease volume.
	Increase volume.
	Enable / Disable the microphone.
	Decrease screen brightness.
	Increase screen brightness.
	Select and set up display devices.
Mode	Change power mode. For more information about power modes, see “Intelligent Cooling” on page 30.
PrtSc	Print screen.
	Open Snipping Tool.
	Open Microsoft® Phone Link.
☆	Launch Lenovo AI Now. Notes: <ul style="list-style-type: none">• This app is available in some countries and regions.• The function varies by countries or regions.

Other general keyboard shortcuts

Key / key combination	Function description
	<ul style="list-style-type: none">• Launch Copilot in Windows.• Launch Windows Search. Note: The function varies by countries or regions.
Fn+ 	Open the context menu of the current active app.
Fn + 	Open the Calculator (for ThinkPad E16 Gen 3).
Fn+ 	Put the computer to sleep (for ThinkPad E16 Gen 3).
Fn+ 	Adjust the keyboard backlight.
Fn+<	Go to beginning.
Fn+>	Go to end.
Fn+Tab	Open Magnifier. Note: Press the Windows logo key+Esc to turn it off.
Fn+4	Enter sleep mode.
Fn+B	Break operation.
Fn+K	Scroll lock.
Fn+P	Pause operation.
Fn+S	Send system request.
Fn+N	Open system information Window.
Fn+G	Enable / Disable the tapping gesture to launch TrackPoint Quick Menu.

You can customize keyboard settings in Vantage app. To customize detailed settings, open the Vantage app, and then click **Device → Input & Accessories**.

For more keyboard shortcuts, go to <https://support.lenovo.com/solutions/windows-support>.

Use the TrackPoint pointing device

The TrackPoint pointing device enables you to perform all the functions of a traditional mouse, such as pointing, clicking, and scrolling.

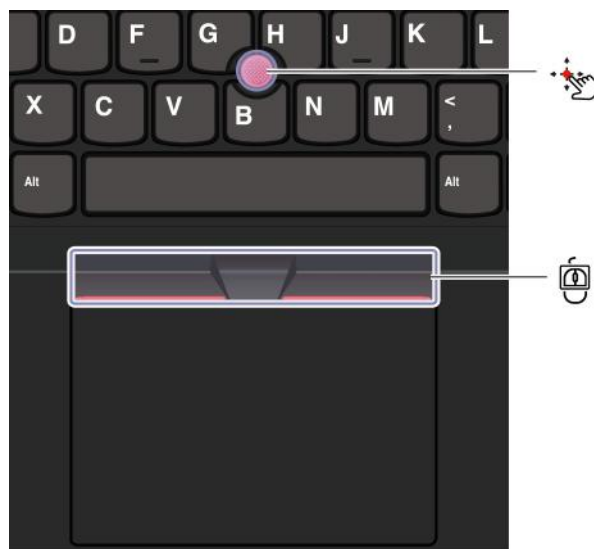

TrackPoint pointing stick

Use your finger to apply pressure to the pointing-stick nonslip cap (hereafter referred to as the red cap) in any direction parallel to the keyboard. The pointer on the screen moves accordingly. The higher the pressure applied, the faster the pointer moves.

TrackPoint Three Buttons

TrackPoint left button and TrackPoint right button correspond to the left and right buttons on a traditional mouse. Press and hold the TrackPoint center button while using your finger to applying pressure to the pointing stick in the vertical or horizontal direction. Then, you can scroll through the document, Web site, or apps.

Press **Ctrl+TrackPoint center button+TrackPoint pointing stick** at the same time to zoom in or zoom out.

Disable the TrackPoint pointing device

The TrackPoint pointing device is enabled by default. You can disable the device and change settings such as the speed of cursor when using the TrackPoint pointing stick and the TrackPoint center button.

To change the settings, do the following:

- Step 1. Type **Mouse settings** in the Windows search box and then press Enter.
- Step 2. Click **TrackPoint settings** and then follow the on-screen instructions to change the settings.

Replace the pointing-stick nonslip cap

Follow below illustration to replace the pointing-stick nonslip cap.



Note: Ensure that the new red cap has grooves **a**.

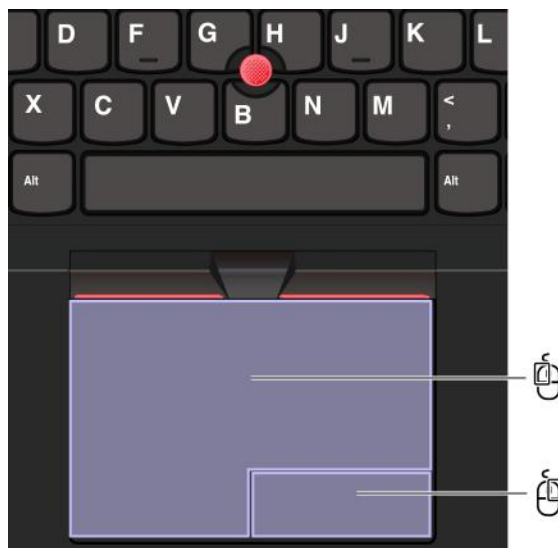

Use the Trackpad

You can use the Trackpad to perform all the pointing, clicking, and scrolling functions of a traditional mouse. It is ideal for you to use for occasions with high portability requirements, for example, business trips.



Item	Description	Item	Description
	Left-click zone		Right-click zone

Notes:

- Some gestures are not available in the following cases:
 - if the last action was done from the TrackPoint pointing device.
 - when you are using certain apps.
 - when you are using two or more fingers and your fingers are too close.
- Trackpad might be insensitive in the following cases:
 - when you position your fingers too close to the edge of Trackpad.
 - when you touch the Trackpad with wet fingers.
 - if the Trackpad surface is stained with water or oil. Turn off the computer first. Then, gently wipe the Trackpad surface with a soft and lint-free cloth that is moistened with lukewarm water or computer cleaner.

Use the touch gestures

Notes:

- When using two or more fingers, ensure that you position your fingers slightly apart.

- Some gestures are not available if the last action was done from the TrackPoint pointing device.
- Some gestures are only available when you are using certain apps.
- If the Trackpad surface is stained with oil, turn off the computer first. Then, gently wipe the Trackpad surface with a soft and lint-free cloth moistened with lukewarm water or computer cleaner.

For more gestures, see the help information of the pointing device.

One-and-two-finger touch gestures

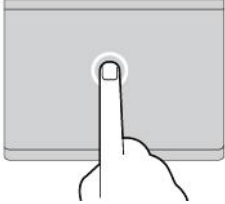
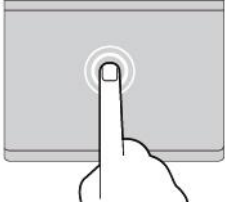
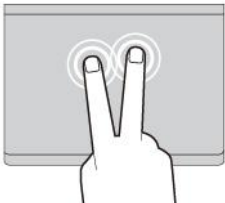
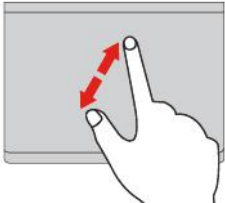
To do this	Gesture
Select an item.	One finger taps once. 
Open an item.	One finger taps twice. 
Display a shortcut menu.	Two fingers tap twice quickly. 
Zoom in.	Two fingers stretch out. 

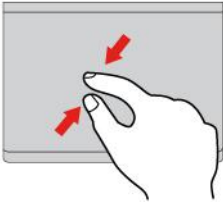
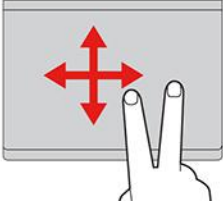
To do this	Gesture
Zoom out.	<p>Two fingers pinch in.</p> 
Scroll through items.	<p>Two fingers slide horizontally or vertically.</p> 

Three-and-four-finger touch gestures

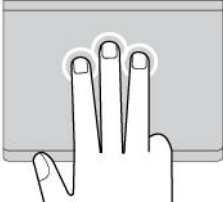
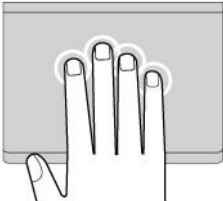
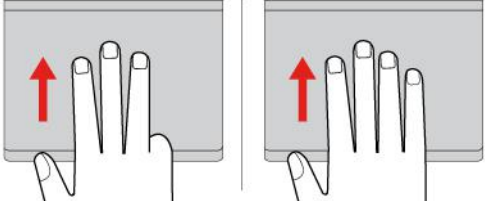
To do this	Gesture
Open search window.	<p>Three fingers tap once.</p> 
Open notification center.	<p>Four fingers tap once.</p> 
Show all windows.	<p>Three- or four-finger swipes up.</p> 

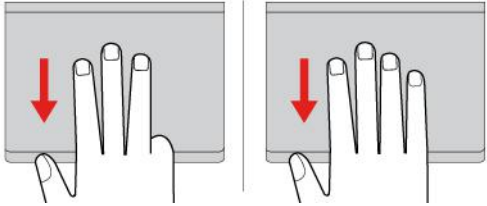
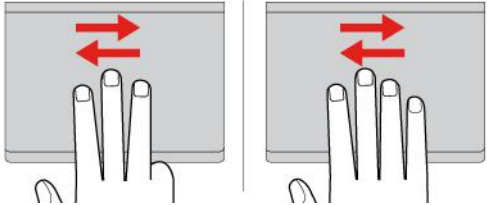
To do this	Gesture
Show the desktop.	<p data-bbox="959 226 1328 254">Three- or four-finger swipes down.</p> 
Switch between open apps or windows.	<p data-bbox="932 518 1356 546">Three- or four-finger swipes left or right.</p> 

Disable the Trackpad

The Trackpad is enabled by default. To disable the device:

- Step 1. Open the **Start** menu, and then click **Settings** → **Bluetooth & devices** → **Touchpad**.
- Step 2. In the **Touchpad** section, turn off the **Touchpad** control.

Use the touch screen (for selected models)

For computers with a touch-enabled screen, you can touch the screen directly with your fingers and interact with computer in a simple way. The following sections introduce frequently used touch gestures.

Notes:

- Some gestures might not be available when you are using certain apps.
- Do not use gloved fingers or incompatible pens for input on the screen. Otherwise, the touch screen might be not sensitive or does not respond.
- The touch screen is delicate. Do not apply pressure on the screen or touch the screen with anything hard or sharp. Otherwise, the touch panel might malfunction or get damaged.

One-finger touch gesture

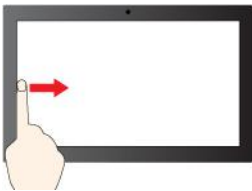
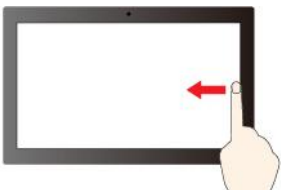
To do this	Gesture
Open a shortcut menu.	Tap and hold. 
Open the widget panel.	Swipe from the left. 
Open notification center.	Swipe from the right. 

Two-finger touch gesture

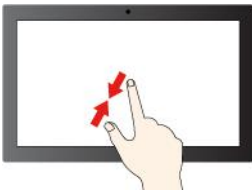
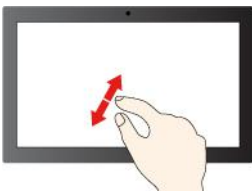
To do this	Gesture
Zoom out.	Move two fingers towards. 
Zoom in.	Spread two fingers apart. 

Three-and-four-finger touch gesture

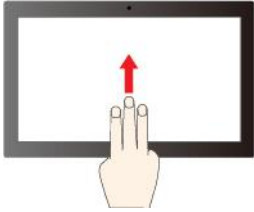
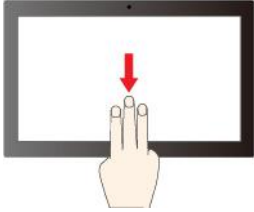
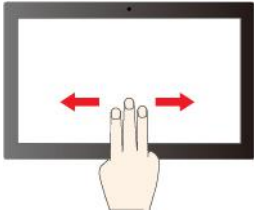
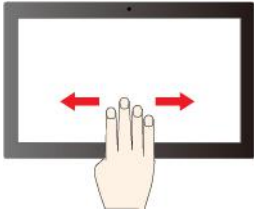
To do this	Gesture
Show all open windows.	Swipe with three fingers up. 
Show the desktop.	Swipe with three fingers down. 
Switch apps.	Swipe with three fingers to the left or right. 
Switch desktops.	Swipe with four fingers to the left or right. 

Enable three-and-four-finger touch gestures (for selected models)

- Step 1. Type **touch gesture** in the Windows search box and then press Enter.
- Step 2. Turn on the **Three- and four-finger touch gestures** switch.

What to do if the touch screen is not sensitive or does not respond

Follow the instructions to troubleshoot the touch screen.

- Step 1. Turn off the computer.
- Step 2. Use a dry, soft, and lint-free cloth or a piece of absorbent cotton to remove fingerprints or dust from the touch screen. Do not apply solvents to the cloth.
- Step 3. Restart the computer and check if the touch screen works normally.
- Step 4. If the touch screen cannot work normally, type **Windows Update** in the Windows search box and then press Enter.

- Step 5. Follow the on-screen instructions to update Windows.
- Step 6. After updating Windows, check if the touch screen works normally.
- Step 7. If the touch screen still cannot work normally, the touch screen might get damaged. You can call Lenovo Customer Support Center to get further help.

Connect to an external display

Connect your computer to a projector or a monitor to give presentations or expand your workspace.

Connect to a wired display

You can connect a wired display with your computer through the USB-C connector and / or HDMI connector.

If your computer cannot detect the external display, right-click a blank area on the desktop and select **Display settings**. Then follow the on-screen instructions to detect the external display.

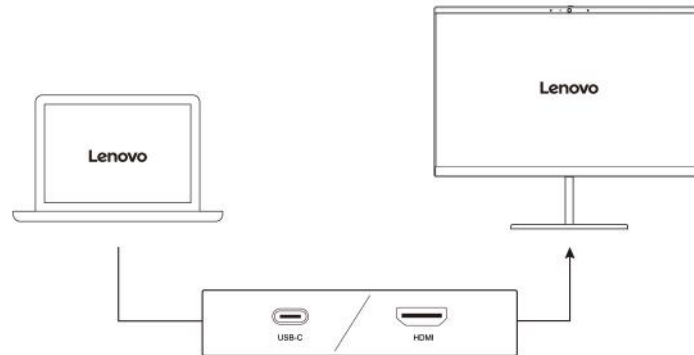

Supported resolution

The following table lists the supported maximum resolution of the external display. **For Intel models**

Connect the external display to	Supported resolution
USB-C power connector (USB 20Gbps)	Up to 5K / 60 Hz
USB-C power connector (Thunderbolt 4)	Up to 8K / 60 Hz
HDMI™ connector	Up to 4K / 60 Hz

For AMD models

Connect the external display to	Supported resolution
USB-C power connector (USB 5Gbps)	Up to 5K / 30 Hz
USB-C power connector (USB4 40Gbps)	Up to 8K / 60 Hz
HDMI™ connector	Up to 4K / 60 Hz

Note: The refresh rate higher than 60 Hz can also be supported. If you set the refresh rate higher than 60 Hz, the maximum resolution might be limited.

Depending on your computer models, your computer supports either of the following:

- For Intel models, the HDMI connector supports the HDMI 2.1 (up to 4K/60Hz) standard. Connect to a compatible digital audio device or video monitor, such as an HDTV.
- For AMD models, the HDMI connector supports the HDMI 2.1 (up to 4K/60Hz) standard by default. Use a qualified HDMI 2.1 cable to connect an external display to your computer. If you use a HDMI 1.4 cable for the connection, it might be incompatible and could potentially impact the functionality of an external display. Do the following to change the HDMI standard of the HDMI connector from 2.1 to 1.4 in the UEFI BIOS menu:
 1. Enter the UEFI BIOS menu , see “Enter the UEFI BIOS menu” on page 41.
 2. Configure **HDMI Mode Select** in the **Config** menu.





Connect to a wireless display

To use a wireless display, ensure that both your computer and the external display support the Miracast® feature.

Press Windows logo key+K and then select a wireless display to connect with.

Set the display mode

Press  or Fn key+ and then select a display mode of your preference.

Press   or Fn key+  and then select a display mode of your preference.

Change display settings

You can change the settings for both the computer display and the external display, such as the main or the secondary display, brightness, resolution, and orientation.

To change the settings, do the following:

- Step 1. Right-click a blank area on the desktop and select **Display settings**.
- Step 2. Select the display that you want to configure and change display settings of your preference.

Chapter 3. Explore your computer

This chapter helps you get full use of your computer.

Lenovo apps

This section introduces Lenovo apps that can enrich your computing experience and improve productivity.

Lenovo Commercial Vantage

The Lenovo Commercial Vantage app (hereafter referred to as Vantage app) is a customized one-stop solution to help you maintain your computer with automated updates and fixes, configure hardware settings, and get personalized support.

To access the Vantage app, type **Lenovo Commercial Vantage** in the Windows search box.

Notes:

- The available features vary depending on the computer model.
- The Vantage app makes periodic updates of the features to keep improving your experience with your computer. The description of features might be different from that on your actual user interface. Ensure that you use the latest version of Vantage app, and apply Windows Update to get the latest updates.

The Vantage app enables you to:

- Know the device status easily and customize device settings.
- Download and install UEFI BIOS, firmware, and driver updates to keep your computer up-to-date.
- Monitor your computer health, and secure your computer against outside threats.
- Scan your computer hardware and diagnose hardware problems.
- Look up warranty status (online).
- Access *User Guide* and helpful articles.
- Temporarily disable the keyboard, screen, Trackpad, and TrackPoint pointing device for cleaning.

Lenovo AI Now (for selected models)

Lenovo AI Now is a personal and private AI assistant to help with inspiration, writing, summarizing, and quick settings for your computer. With local AI models, it can ensure your data security and provide a secure AI experience.

Launch Lenovo AI Now

Press F12 or type **Lenovo AI Now** in the Windows search box to launch Lenovo AI Now.

Explore key features

- **Knowledge Assistant:** Search for documents, retrieve information, summarize content, and generate reports based on your personal knowledge base.

Note: To experience Knowledge Assistant, you have to import documents and build your knowledge base first.

- **PC Assistant:** Set up and optimize your computer. It provides smart setup features and can connect you to timely Lenovo services. For example, you can ask AI Now to help turn on Eye Care mode or find the nearest service center.

Notes:

- To quickly chat with Lenovo AI Now, you can launch the AI Now mini window by pressing Ctrl+Q.
- Lenovo AI Now makes periodic updates to keep bringing the latest AI technologies to you and improving your experience. The description of features might be different from that on your actual user interface. For the latest information about Lenovo AI Now, go to https://support.lenovo.com/solutions/lenovo-ai-apps#lenovo_ai_now.
- This app is available in some countries and regions.

Lenovo Smart Connect

Lenovo Smart Connect helps you bridge up your computer, phone, and tablet together into one device virtually to share files, extend the screen, stream the content, and other collaborative features.

Access Lenovo Smart Connect

Type **Lenovo Smart Connect** in the Windows search box and then press Enter.

Pair up your devices

- Wireless network
 1. Launch Lenovo Smart Connect on your computer and your phone or tablet.
 2. Use your phone or tablet to scan the QR code on the computer screen and follow the on-screen instructions.
- Wired connection
 1. Connect your computer with your tablet or phone using a cable and follow on-screen instructions.

Explore key features

- **Cross control:** Control your phone or tablet using the keyboard and mouse on the computer.



- **Share hub:** Seamlessly share the content among your devices through a window to have files and documentations transferred.



- **App streaming:** Stream apps from your phone or tablet to the computer.



- **Webcam:** Make video calls using the camera of your phone or tablet.

Note: Select the correct camera option in the meeting app to use the webcam.

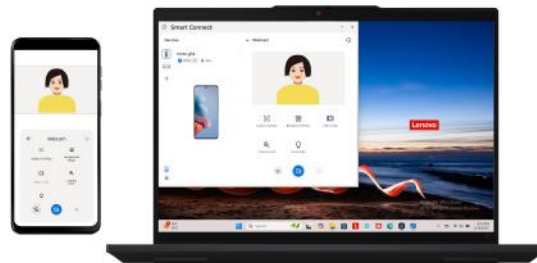

- **Extend PC display:** Extend your computer screen to your tablet to share the screen.

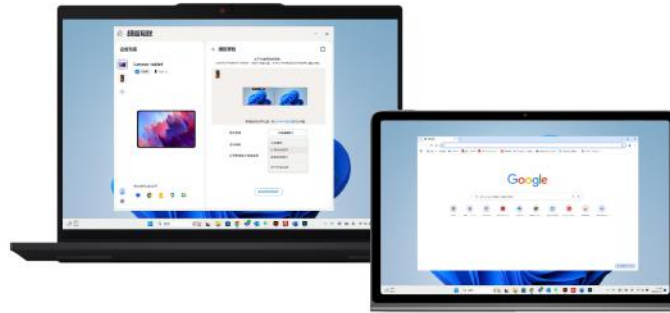

- **Phone on PC:** Mirror or virtualize your phone on your computer to access mobile functions.

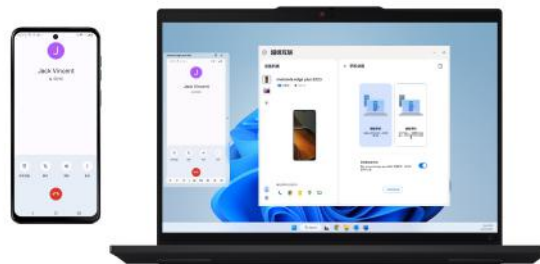

Notes:

- The available features vary depending on the computer model, the phone model, and the tablet model.
- Lenovo Smart Connect periodically updates features to improve device collaboration experience. The feature description might be different from that on your actual user interface.

Lenovo Smart Meeting

Lenovo Smart Meeting is a video conferencing app for working scenarios. It integrates multiple features to help enhance your professional image, protect your privacy, and reduce power consumption.

If you want your configurations of the app also take effect on other mainstream video call apps, such as Microsoft Teams and Zoom, ensure that you select Lenovo Virtual Camera in the app.

Access the app

Type **Lenovo Smart Meeting** in the Windows search box and then press Enter.

Explore key features

- **Smart appearance**
 - **Video enhancer:** Adjust the brightness automatically for better image quality in the video call.



- **Face framing:** Keep your face centered in the video call automatically when you move around.



- **Customized background:** Blur or customize your background in the video call to protect your privacy.



- **Temporary Avatar:** Create and display a temporary portrait of you as if you are still on the video conference when you are temporarily away.

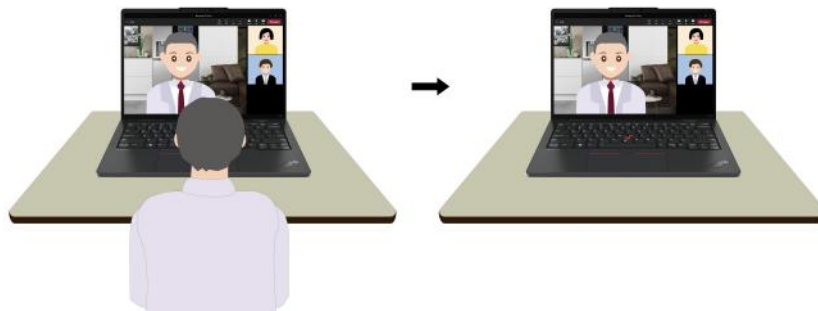

Notes:

- Lenovo does not collect any personal data from this app.
- The available features vary depending on the computer model.
- Lenovo Smart Meeting makes periodic feature updates to keep improving your experience with your computer. The description described here might be different from that on your actual user interface.

TrackPoint Quick Menu

TrackPoint Quick Menu is a clickable app. It offers rapid access to functions, such as camera and microphone. You can adjust the function settings in this app.

Launch the TrackPoint Quick Menu

Double-tap the TrackPoint pointing stick to launch the TrackPoint Quick Menu. You can also set single-tapping as the launch gesture.

Note: If the TrackPoint Quick Menu does not pop up after you use the launch gesture, this case might be caused by the displacement of the TrackPoint pointing stick due to too much force applied on it. Wait 15 to 30 seconds and try again.

To change the settings, do the following:

Step 1. Click the flyout ⓘ and click **ADVANCED SETTINGS**.

Step 2. Select **Single-tapping** under **TrackPoint Quick Menu Launch**.

The TrackPoint Quick Menu is enabled by default. Press Fn+G to disable or enable the tapping gesture. When disabled, it cannot be launched by tapping the TrackPoint pointing stick.



Use the TrackPoint Quick Menu

You can click the edit button ✎ to rearrange the features in the preview panel, or drag and drop the features on the right to the preview panel to customize your quick menu.

- **Camera**

You can adjust the brightness and contrast of the camera, and restore the settings to default by tapping the reset button ↺.

- **Microphone**

You can mute your computer, and adjust the sound effect of your microphone by selecting the following modes:

- Center mode: Capture the speaker's voice.
- Spatial mode: Capture the speaker's voice and the ambience.

Note: When internal microphone is not supported by Dolby or the Dolby driver is disabled, an input device list will be displayed instead. The list provides options and one volume bar to test your microphone.

- **Voice typing**

You can convert the speech to text in the text box. Click **START VOICE TYPING** to invoke the text box.

- **Battery**

You can extend the battery lifespan and health by setting the charging threshold below 100%.

To set the threshold, enable the feature and click **ADJUST THRESHOLD**. Then set the charge threshold in the Vantage app.

- **Audio playback**

You can select the output device of your preference and set the volume of your selected channel or mute it.

- **Noise suppression**

You can suppress your own background noise and the noise from other meeting participants.

- Off: Disable noise suppression.
- Low: Suppress low-level background noise.
- High: Suppress all non-speech background noise.

Note: The feature does not work when Dolby Voice is off. Click the link in **NOISE SUPPRESSION** to help you enable it.

- **Quick Clean**

You can temporarily disable the keyboard, screen, Trackpad, and TrackPoint pointing device to clean your computer.

Note: The features might vary due to periodic updates. For details of the version installed on your computer, click the flyout ⓘ at the top-right corner of the page and click **LEARN MORE**.

Copilot in Windows

Copilot in Windows is an AI-powered assistant to help enhance work efficiency and creativity.

To access Copilot in Windows, do one of the following:

- Press the Copilot key .
- Click the Copilot icon  on the task bar.

Key functions

- Provide answers or suggestions to your questions through live chat. For example, you could ask Copilot how to change your Windows password.
- Assist you to analyse image by clicking the image button at the bottom right of the chat box. For example, you could ask Copilot to summarize the image you have uploaded.

Notes:

- This app might not be available in your country or region.
- This app makes periodic updates of the features. Explore this app on your actual user interface.

Intelligent Cooling



The Intelligent Cooling feature helps you adjust power consumption, fan speed, computer temperature, and performance.

Note: In balanced mode or best performance mode, avoid keeping your hands, your lap, or any other part of your body in contact with a hot section of the computer for 10 seconds or longer.

Mode	Recommended scenario
Best power efficiency	<ul style="list-style-type: none"> You want the computer to be quieter and cooler. You want to maximize the battery life.
Balanced	<ul style="list-style-type: none"> You plan to frequently switch between different computer tasks over a period time. You prefer to balance device performance with temperature and fan noise.
Best performance	<ul style="list-style-type: none"> You want the computer to achieve the best performance. Louder fan noise and higher temperature are acceptable to you.

Switch among modes

You can press F8 or do the following to switch among preferred modes:

- Step 1. Right-click the battery icon in the quick settings area    on the right side of the taskbar.
- Step 2. Click **Power and sleep settings**.
- Step 3. Locate the **Power mode** section and select a preferred mode.

Intelligent Cooling Boost (for AMD models only)

The Intelligent Cooling Boost feature dynamically adjusts system performance based on the apps you are running. It is recommended that you enable this function when using unified communication apps (such as Microsoft Teams).

Note: Ensure that you use this feature in Balanced mode to have the best user experience.

The Intelligent Cooling Boost feature is enabled by default. To disable this feature, do the following:

- Step 1. Restart the computer. When the logo screen is displayed, press F1 to enter to the UEFI BIOS menu.
- Step 2. Select **Config → Power**.
- Step 3. In the **Intelligent Cooling Boost** section, turn off the **Intelligent Cooling Boost** switch.
- Step 4. Press F10 to save changes and exit the UEFI BIOS menu.

Cool and Quiet on Lap

Your computer can detect whether you are using it on your lap and automatically enable the Cool and Quiet on Lap feature. The feature helps cool down your computer to avoid any discomfort caused by extended contact with your body, even through clothing. When you are not using it on your lap, the feature will be disabled automatically.

Manage power

Use the information in this section to achieve the best balance between performance and power efficiency.

Check the battery status

Check the battery status to help use computer properly.

Go to **Settings** → **System** to check the battery status. For more details about your battery, refer to the Vantage app.

Charge the computer with ac power

Power source of the ac power adapter:

- Power: 65 W and 100 W (for selected Intel models)
- Sine-wave input at 50 Hz to 60 Hz
- Input rating of the ac power adapter: 100 V to 240 V ac, 50 Hz to 60 Hz
- Output rating of the ac power adapter:
 - 65 W: 20 V dc, 3.25 A
 - 100 W: 20 V dc, 5 A

When the battery power is low, charge your battery by connecting your computer to ac power with the supplied power adapter. Both the 65 W and the 100 W ac power adapters support rapid charge pro with 48 Wh and 64 Wh batteries. The battery is 50% charged in about half an hour when the computer is turned off. The actual charging time depends on the battery size, the physical environment, and whether you are using the computer.

Battery charging is also affected by its temperature. The recommended temperature range for charging the battery is between 20°C (60°F) and 45°C (105°F).

Note: Some models might not ship with ac adapters or power cords. Use only the certified adapters and power cords that comply with the requirements of relevant national standards (such as UL/EN/IEC 62368-1) to charge the product. It is recommended to use the Lenovo qualified adapters. Unqualified adapters may cause hazards. You can refer to <https://www.lenovo.com/us/en/compliance/eu-doc>.



Maximize the life of the battery

Follow the instructions to maximize the life of the battery.

- Use the battery until the charge is depleted and recharge the battery completely before using it. Once the battery is fully charged, it must discharge to 94% or lower before it will be allowed to recharge again.
- Keep the battery from full charge when it is not in heavy use. For more information, refer to the **Battery settings** tab in the **Power** section of the Vantage app.
- The battery might optimize its full charge capacity based on your usage. After prolonged periods of limited use, full battery capacity might not be available until you discharge to as low as 20% and recharge completely. For more information, refer to the **Battery settings** tab in the **Power** section of the Vantage app.

Charge your computer with P-to-P 2.0 charging function

Both USB-C connectors (Thunderbolt 4) on the computer feature the Lenovo-unique P-to-P 2.0 (Peer to Peer 2.0) charging function.

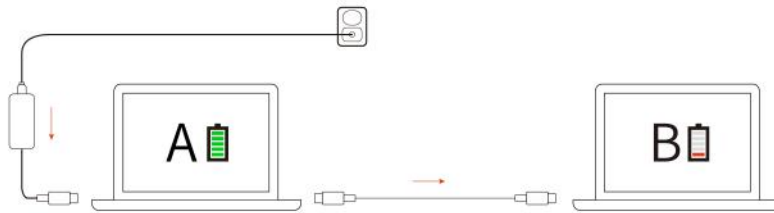

Note: The actual charging speed of your computer depends on many factors, such as the remaining battery power of the computers, the wattage of the ac power adapter, and whether you are using the computers.

To use the function, ensure that **Always On USB** and **Charge in Battery Mode** are enabled in UEFI BIOS of your computers, so that the function works even when the computers are off or in hibernation mode. To enable **Always On USB** and **Charge in Battery Mode**:

- Step 1. Restart the computer. When the logo screen is displayed, press F1 to enter to the UEFI BIOS menu.
- Step 2. Click **Config** → **USB**, and then to enable **Always On USB** and **Charge in Battery Mode**.

Change the power settings

Follow the instructions to change the power settings of your preference.

For ENERGY STAR® compliant computers, the following power plan takes effect by default when your computer is on ac power and has been idle for a specified duration:

- Turn off the display: After 5 minutes
- Put the computer to sleep:
 - Intel models: After 5 minutes
 - AMD models: After 5 minutes

To change the power plan, the power button function and other settings, do the following:

- Step 1. Go to **Control Panel** and view by Large icons or Small icons.
- Step 2. Click **Power Options**.
- Step 3. Change the settings as you prefer.

Transfer data

Quickly share your files using the built-in Bluetooth among devices with the same features.

Connect to a Bluetooth device

You can connect all types of Bluetooth-enabled devices to your computer, such as a keyboard, a mouse, a smartphone, or speakers. To ensure successful connection, place the devices at most 10 meters (33 feet) from the computer.

Conventional pair

This topic helps you connect to a Bluetooth device by conventional pair.

- Step 1. Type **Bluetooth** in the Windows search box and then press Enter.
- Step 2. Turn on both the Bluetooth on your computer and the Bluetooth device. Make sure the device is discoverable.
- Step 3. Select the device when it is displayed on the **Add device** list, and then follow the on-screen instructions.

Swift pair

This topic helps you connect to a Bluetooth device by swift pair.

If your Bluetooth device supports swift pair, do the following:

- Step 1. Enable swift pair notification on Bluetooth settings page.
- Step 2. Turn on both the Bluetooth on your computer and the Bluetooth device. Make sure the device is discoverable.
- Step 3. Click **Connect** when a swift pair notification appears on your computer.

Chapter 4. Secure your computer and information

Your computer can safeguard your privacy and information through some privacy protection functions.

Lock the computer

Lock your computer to a desk, table, or other fixtures through a compatible security cable lock.

Note: The slot supports cable locks that conform to the Kensington ManoSaver® lock standards using Cleat™ locking technology. You are responsible for evaluating, selecting, and implementing the locking device and security feature. Lenovo is not responsible for the locking device and security feature. You can purchase the cable locks at <https://smartfind.lenovo.com>.

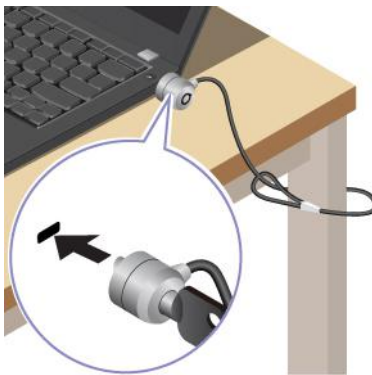

Log in with fingerprint recognition

The fingerprint reader is integrated with the power button. You can power on and log in to the computer with your fingerprint. It eliminates the need to enter complex passwords, saving your time and boosting your productivity.

To enroll your fingerprints, do the following:

- Step 1. Type **Sign-in options** in the Windows search box and then press Enter.
- Step 2. Select **Fingerprint recognition (Windows Hello)** and then follow the on-screen instruction to enroll your fingerprint.

Note: It is recommended that you put your finger at the center of the fingerprint reader key during enrollment and enroll more than one fingerprint in case of any injuries to your fingers. After the enrollment, the fingerprints are associated with the Windows password automatically.

- Step 3. Log in with your fingerprint. When the fingerprint reader indicator is solid green, tap your finger on the fingerprint reader for authentication.

- ThinkPad E14 Gen 7

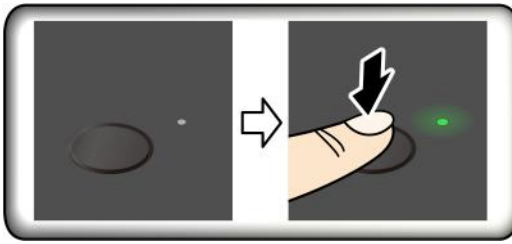

- ThinkPad E16 Gen 3

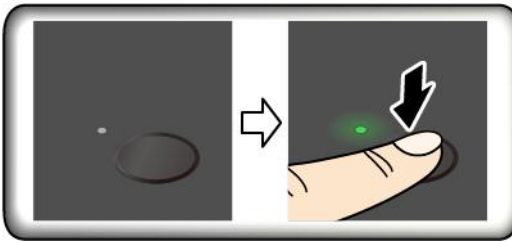

Note: You can associate your fingerprints with your power-on password and NVMe password. See “Associate your fingerprints with passwords (for selected models)” on page 39.

Maintenance tips:

- Do not scratch the surface of the reader with anything hard or sharp.
- Do not use or touch the reader with a wet, dirty, wrinkled, or injured finger.

Log in with facial recognition (for selected models)

You can log in to the computer with your facial recognition. It provides precise and secure authentication.

For models come with a webcam privacy shutter, slide the webcam privacy shutter to uncover the camera lens before using the Windows Hello face recognition.

Set up facial recognition and unlock your computer by scanning your face:

- Step 1. Type **Sign-in options** in the Windows search box and then press Enter.
- Step 2. Select **Facial recognition (Windows Hello)** and then follow the on-screen instruction to enroll your facial ID.

Protect data against power loss

NVMe (Non-Volatile Memory express) M.2 solid-state drive features the Lenovo-unique PLP (Power Loss Protection) function to avoid data loss or damage.

If your computer is not responding and you might have to shut down your computer by pressing and holding the power button for several seconds. In this case, the PLP function enables your computer data to be saved timely. However, there is no guarantee that all data is saved in any situation.

To check the type of your M.2 solid-state drive:

- Step 1. Restart the computer. When the logo screen is displayed, press F10 to enter the Lenovo diagnostics window.
- Step 2. On the TOOLS tab, select **SYSTEM INFORMATION → STORAGE** using the arrow keys.

Step 3. Locate the **Device Type** section to check the information.

UEFI BIOS passwords

You can set passwords in UEFI (Unified Extensible Firmware Interface) BIOS (Basic Input/Output System) to strengthen the security of your computer.

Password types

You can set a power-on password, supervisor password, system management password, or NVMe password in UEFI BIOS to prevent unauthorized access to your computer.

However, you are not prompted to enter any UEFI BIOS password when your computer resumes from sleep mode.

Power-on password

If you set a power-on password, a window is displayed on the screen when you turn on the computer. Enter the correct password to use the computer.

Supervisor password

The supervisor password protects the system information stored in UEFI BIOS. When entering the UEFI BIOS menu, enter the correct supervisor password in the window prompted. You also can press Enter to skip the password prompt. However, you cannot change most of the system configuration options in UEFI BIOS.

If you have set both the supervisor password and power-on password, you can use the supervisor password to access your computer when you turn it on. The supervisor password overrides the power-on password.

NVMe passwords

The NVMe password prevents unauthorized access to the data on the storage drive. When an NVMe password is set, you are prompted to type a correct password each time you try to access the storage drive.

- **Single Password**

When a Single NVMe password is set, the user must enter the user NVMe password to access files and applications on the storage drive.

- **Dual Password (User+Admin)**

The admin NVMe password is set and used by a system administrator. It enables the administrator to access any storage drive in a system or any computer connected in the same network. The administrator can also assign a user NVMe password for each computer in the network. The user of the computer can change the user NVMe password as desired, but only the administrator can remove the user NVMe password.

When prompted to enter an NVMe password, press F1 to switch between the admin NVMe password and user NVMe password.

Notes: The NVMe password is not available in the following situations:

- A Trusted Computing Group (TCG) Opal-compliant storage drive and a TCG Opal management software program are installed in the computer, and the TCG Opal management software program is activated.
- An eDrive storage drive is installed in the computer preinstalled with the Windows operating system.

System management password

The system management password can also protect the system information stored in UEFI BIOS like a supervisor password, but it has lower authority by default. The system management password can be set through the UEFI BIOS menu or through Windows Management Instrumentation (WMI) with the Lenovo client-management interface.

You can enable the system management password to have the same authority as the supervisor password to control security-related features. To customize the authority of the system management password through the UEFI BIOS menu:

- Step 1. Restart the computer. When the logo screen is displayed, press F1 to enter the UEFI BIOS menu.
- Step 2. Select **Security → Password → System Management Password Access Control**.
- Step 3. Follow the on-screen instructions.

If you have set both the supervisor password and the system management password, the supervisor password overrides the system management password. If you have set both the system management password and the power-on password, the system management password overrides the power-on password.

Set, change, or remove a password

Follow the instructions to set, change or remove a password.

Before you start, print these instructions.

- Step 1. Restart the computer. When the logo screen is displayed, press F1 to enter the UEFI BIOS menu.
- Step 2. Select **Security → Password** by using the arrow keys.
- Step 3. Select the password type. Then, follow the on-screen instructions to set, change, or remove a password.

You should record all your passwords and store them in a safe place. If you forget any of your passwords, any potential repair actions required are not covered under warranty.

What to do if you forget your power-on password

Follow the instructions to remove the power-on password if you forget your power-on password.

If you have set a supervisor password or a system management password and remember it:

- Step 1. Restart the computer. When the logo screen is displayed, immediately press F1.
- Step 2. Type the supervisor password or the system management password to enter the UEFI BIOS menu.
- Step 3. Select **Security → Password → Power-On Password** by using the arrow keys.
- Step 4. Type the current supervisor password or the system management password in the **Enter Current Password** field. Then, leave the **Enter New Password** field blank, and press Enter twice.
- Step 5. In the Changes have been saved window, press Enter.
- Step 6. Press F10 to save changes and exit the UEFI BIOS menu.

If you have not set a supervisor password or a system management password, contact a Lenovo-authorized service provider to have the power-on password removed.

What to do if you forget your system management password

Follow the instructions to remove the system management password if you forget your system management password.

If you have set a supervisor password and remember it:

- Step 1. Restart the computer. When the logo screen is displayed, immediately press F1.
- Step 2. Type the supervisor password to enter the UEFI BIOS menu.
- Step 3. Select **Security → Password → System Management Password** by using the arrow keys.
- Step 4. Type the current supervisor password in the **Enter Current Password** field. Then, leave the **Enter New Password** field blank, and press Enter twice.
- Step 5. In the Changes have been saved window, press Enter.
- Step 6. Press F10 to save changes and exit the UEFI BIOS menu.

If you have not set a supervisor password, contact a Lenovo-authorized service provider to have the system management password removed.

What to do if you forget your NVMe password

Follow the instructions to remove the NVMe password if you forget your NVMe password.

If you forget your NVMe password (Single password) or both user and admin NVMe passwords (Dual password), Lenovo cannot reset your passwords or recover data from the storage drive. You can contact a Lenovo-authorized service provider to have the storage drive replaced. A fee will be charged for parts and service. If the storage drive is a CRU (Customer Replaceable Unit), you can also contact Lenovo to purchase a new storage drive to replace the old one by yourself. To check whether the storage drive is a CRU and the relevant replacement procedure, see “CRU list” on page 96.

What to do if you forget your supervisor password

There is no service procedure to remove the password. You can contact a Lenovo-authorized service provider to have the system board replaced. A fee will be charged for parts and service.

Associate your fingerprints with passwords (for selected models)

You can associate the fingerprints with passwords to get quick access to the computer and the data on the storage drive without entering the power-on password or NVMe password.

Do the following to associate your fingerprints with the power-on password and NVMe password:

- Step 1. Turn off and then turn on the computer.
- Step 2. When prompted, scan your finger on the fingerprint reader.
- Step 3. Enter your power-on password, NVMe password, or both as required. The association is established.

When you start the computer again, you can use your fingerprints to log in to the computer without entering your Windows password, power-on password, or NVMe password. To change settings, press F1 to enter the UEFI BIOS menu, and then select **Security → Fingerprint**.

Attention: If you always use your fingerprint to log in to the computer, you might forget your passwords. Write down your passwords, and keep them in a safe place.

FIDO (Fast Identity Online) authentication

Your computer supports FIDO (Fast Identity Online) authentication feature. This feature works as an alternative to password-based authentication to achieve passwordless authentication.

This feature only works when a power-on password is set in UEFI BIOS and the FIDO2 USB device is registered in ThinkShield™ Passwordless Power-On Device Manager. With this feature, you can input the power-on password or use the registered FIDO2 USB device to power on your computer.

Register FIDO2 USB device in ThinkShield Passwordless Power-On Device Manager

Follow the instructions to register FIDO2 USB device in ThinkShield Passwordless Power-On Device Manager.

- Step 1. Turn on the computer.
- Step 2. Press F12 during the power-on process.
- Step 3. If you set a power-on password, you are prompted to enter the correct password.
- Step 4. Select **App Menu → ThinkShield Passwordless Power-On Device Manager** and press Enter
- Step 5. Insert the FIDO2 USB device to register the device by following steps:
 - a. Select the available FIDO2 USB device that you want to register in the **Discovered Devices** field.
 - b. Click **Yes** in the displayed window to confirm the device you selected
 - c. If you set a power-on password, you are prompted to enter the correct password.
 - d. The **User operation request** window is displayed. You are prompted to press the button on the connected FIDO2 USB device, and then follow the on-screen instructions to close the window.
 - e. Press Esc to exit and restart your computer.

Notes:

- If you want to unregister your devices, click the available FIDO2 USB device that you want to unregister in the **My Device** field and enter the correct power-on password for verification.
- If you use more than one FIDO2 USB device with a common identifier for registration, only one device is available.

Log in to the System with Passwordless Power-On Authentication

Follow the instructions to log in to the System with Passwordless Power-On Authentication.

- Step 1. Restart the computer.
- Step 2. **ThinkShield Passwordless Power-On Authentication** window is displayed.
- Step 3. Insert your registered FIDO2 USB device for detection.
- Step 4. Then follow the on-screen instructions to press the button on your FIDO2 USB device for verification.
- Step 5. After your device is verified, the power-on process continues.

Note: You should insert the FIDO2 USB device or enter the power-on password within 60 seconds. Otherwise, your computer will shut down automatically.

Chapter 5. Configure advanced settings

UEFI BIOS

UEFI BIOS is the first program that the computer runs. When the computer turns on, the UEFI BIOS performs a self test to make sure that various devices in the computer are functioning properly.

Enter the UEFI BIOS menu

Turn on or restart the computer. When the logo screen is displayed, press F1 repeatedly to enter the UEFI BIOS menu.

Navigate the UEFI BIOS menu

Follow the on-screen instructions to navigate in the UEFI BIOS menu.

The table below introduces some available settings of the UEFI BIOS menu. To know more about the UEFI BIOS, for example, BIOS Event log, you can go to <https://pcsupport.lenovo.com> and then type **UEFI BIOS** in search box.

Note: The UEFI BIOS menu might vary depending on system configurations.

Menu	Introduction
Main	This category displays the general product-related information, such as UEFI BIOS version, machine type, system serial number, preinstalled OS license, and BIOS Event log.
Config	This category enables you to update configurations relating to system settings such as network, USB, keyboard, display, CPU, and power.
Date/Time	This category enables you to set computer date and time in this category.
Security	This category enables you to configure security settings related to such as password, fingerprint, and I/O accessibility.
Startup	This category enables you to manage settings relevant to booting up.
Restart	This category enables you to save or discard changes before exiting.

You can go to Lenovo BIOS Simulator Center <https://download.lenovo.com/bSCO/index.html> to explore the detailed settings by your product name.

Note: The Lenovo BIOS Simulator Center makes periodic updates of the settings. The UEFI BIOS simulator interface and description of settings might be different from that on your actual user interface.

Customize BIOS Defaults

The feature provides a solution to backup your preferred BIOS Setup settings.

It helps you to save the BIOS Setup settings as customized BIOS default settings, load them to current BIOS settings when needed, and reset the settings to Setup Defaults.

Save the customized settings configuration

Follow the instructions to save the customized settings configuration.

Step 1. Restart the computer. When the logo screen is displayed, press F1 to enter the UEFI BIOS menu.

Step 2. Select **Restart → Save Custom Defaults**.

Step 3. Click **Yes** to save the settings configuration you customized.

Load the customized settings configuration

Follow the instructions to load the customized settings configuration.

Step 1. Restart the computer. When the logo screen is displayed, press F1 to enter the UEFI BIOS menu.

Step 2. Select **Restart → Load Custom Defaults**.

Step 3. Click **Yes** to load the customized settings configuration you saved.

You can also press F9 and click **Custom Defaults** to load the customized settings configuration.

Note: **Load Custom Defaults** is unavailable if no customized BIOS default settings are saved.

Reset the settings configuration to Setup Defaults

Follow the instructions to reset the settings configuration to Setup Defaults.

Step 1. Restart the computer. When the logo screen is displayed, press F1 to enter the UEFI BIOS menu.

Step 2. Select **Restart → Load Factory Defaults**.

Step 3. Click **Yes** to reset the settings configuration to Setup Defaults.

You can also press F9 and click **Factory Defaults** to reset the settings configuration to Setup Defaults.

Detect memory retraining (for Intel models only)

Memory retraining is a process to initialize the memory module and run diagnostic tests for the memory module in your computer.

The memory retraining might occur during POST if any of the following situations is detected:

- Memory module replacement
- Total Memory Encryption setting change in the UEFI BIOS
- Memory Reference Code (MRC) change when the UEFI BIOS updates

When memory retraining occurs, the screen might be blank. You might see the LED indicators on Esc, F1, and F4 blinking sequentially to indicate the progress. Do not press the power button to interrupt the process. Wait a few minutes until the logo screen is displayed.

Chapter 6. Frequently asked questions

This chapter provides solutions to some hardware and software issues.

Camera problems

My camera can't be launched or found

Problem: What should I do if my camera can't be launched or found?

Solution: If your camera can't be launched or found, try the following solutions one by one to troubleshoot and fix the issue:

1. If you are using an external camera, ensure that it is connected to a working USB connector on your computer.
2. If you are using an integrated camera, ensure that it is uncovered and enabled. Take the following steps:
 - a. Open the camera shutter.
 - b. Open the Start menu, click **Settings** → **Bluetooth & devices** → **Cameras**, and enable the camera.
3. Authorize apps to have access to the camera. Take the following steps:
 - a. Open the **Start** menu, and select **Settings** → **Privacy & security** → **Camera**.
 - b. Turn on **Camera access** switch and **Let apps access your camera** switch.
4. Unblock access to the camera in your antivirus software settings.
5. Update the camera driver. Take the following steps:
 - a. Type **device manager** in the Windows search box and then press Enter.
 - b. Click **Device Manager** from the list of results. The Device Manager window opens.
 - c. Click arrow icon > next to **Cameras** to expand the section.
 - d. Right-click the camera that you would like to update.
 - e. Select **Update driver** and follow the on-screen instructions.
6. Run the automated camera troubleshooter in the Get Help app. Take the following steps:
 - a. Open the **Start** menu and click **Settings** → **Privacy & security** → **Camera**.
 - b. Scroll down to the bottom. Click **Get help** and follow the on-screen instructions.

If the problem persists, do not hesitate to call Lenovo Customer Center. For the latest Lenovo Support phone numbers for your country or region, go to <https://pcsupport.lenovo.com/supportphonenumberlist>.

Audio problems

The audio does not work

Problem: What should I do if the audio does not work?

Solution: If you encounter any audio problems, such as no audio or malfunctioning audio, try the following solutions one by one to troubleshoot and fix the issue:

1. If you are using an external audio device, ensure that the device is properly connected to your computer.
2. Verify your audio settings. Take the following steps:

- a. Go to **Start → Settings → System → Sound**.
 - b. Verify that the sound output and input devices are selected correctly.
 - c. Verify that the volume is properly set and your computer is not muted.
3. Run the audio troubleshooter. Take the following steps:
- a. Go to **Start → Settings → System → Sound**.
 - b. Under **Advanced**, find **Troubleshoot common sound problems**, and click **Output devices** or **Input devices** to troubleshoot and fix the problem.

For more solutions to audio problems, go to <https://support.lenovo.com/solutions/ht501860>.

If the problem persists, do not hesitate to call Lenovo Customer Center. For the latest Lenovo Support phone numbers for your country or region, go to <https://pcsupport.lenovo.com/supportphonenumber>.

Mouse problems

My mouse does not work

Problem: What should I do if my mouse does not work?

Solution: If you encounter mouse problems such as mouse not responding or mouse cursor disappearing, try the following solutions one by one to troubleshoot and fix the issue:

1. Ensure the power switch on your mouse is turned on.
2. If you are using a wireless mouse, try the following solutions one by one:
 - Ensure that the battery power is enough for working.
 - If it is connected through a USB dongle, ensure that the USB dongle is connected to a working USB connector of your computer. The USB dongle is usually stored within the battery compartment of the mouse.
 - If it is a Bluetooth mouse, ensure that the Bluetooth connection with your computer is correct. If there is a Bluetooth connection problem, refer to “Bluetooth connection problems” in this *User Guide*.
3. If you are using a wired mouse, try the following solutions one by one:
 - Connect it to a working USB connector on your computer correctly.
 - Connect another wired mouse to the same USB connector. If it is connected correctly and works well, there may be something wrong with the original mouse.
4. Update the mouse driver. Take the following steps:
 - a. Type **device manager** in the Windows search box.
 - b. Click **Device Manager** from the list of results. The Device Manager window opens.
 - c. Click arrow icon > next to **Mice and other pointing devices** to expand the section.
 - d. Right-click the mouse driver, click **Update driver**, and then follow the on-screen instructions to update the driver.

If the problem persists, do not hesitate to call Lenovo Customer Center. For the latest Lenovo Support phone numbers for your country or region, go to <https://pcsupport.lenovo.com/supportphonenumber>.

Keyboard problems

My keyboard does not work

Problem: What should I do if my keyboard does not work?

Solution: If your keyboard does not work or types wrong characters, try the following solutions one by one to troubleshoot and fix the issue:

1. Ensure that the keyboard is well connected.
 - If you are using a wired keyboard, check if it is connected to your computer correctly or try to connect the keyboard to another compatible connector on your computer.
 - If you are using a wireless keyboard, ensure that your keyboard is powered on. Check if the dongle is connected to your computer correctly or the Bluetooth connection with your computer is established.
2. Ensure that the keyboard layout settings are correct. Take the following steps:
 - a. Go to **Settings → Time & language → Language & region**.
 - b. Under **Preferred languages**, click on the three horizontal dots next to your primary language preference and select **Language options**.
 - c. Under **Installed keyboards**, check the keyboard layout and add the corresponding keyboard if you're not using the right one.
3. Ensure that the keyboard is in good status. Take the following steps:
 - a. Type **device manager** in the Windows search box and then press Enter.
 - b. Click **Device Manager** from the list of results. The Device Manager window opens.
 - c. Click arrow icon > next to **Keyboard** to expand the section.
 - d. Double-click the keyboard that is not working and check the status.
 - e. If it is not working properly, select **Driver** from the tabs on the top and click **Uninstall device** to uninstall the device.
 - f. Apply Windows Update to install the latest driver automatically.
4. Ensure that the sticky keys and filter keys are disabled. Take the following steps:
 - a. Open the **Start** menu, and click **Settings → Accessibility → Keyboard**.
 - b. Disable **Sticky keys** switch and **Filter keys** switch.
5. Clean the keyboard.
 - For external keyboard, take the following steps:
 - a. Disconnect your keyboard.
 - b. Turn the keyboard upside down and gently shake it.
 - c. Use compressed air to blow out the dirt and debris from underneath the keys.
 - d. Use a cotton swab dipped in rubbing alcohol to remove stickiness around and underneath stuck keys.
 - For integrated keyboard, take the following steps:
 - a. Turn off your computer.
 - b. Use compressed air to blow out the dirt and debris from underneath the keys.
 - c. Use a cotton swab dipped in rubbing alcohol to remove stickiness around and underneath stuck keys.
6. Restart your computer.

If the problem persists, do not hesitate to call Lenovo Customer Center. For the latest Lenovo Support phone numbers for your country or region, go to <https://pcsupport.lenovo.com/supportphonenumberlist>.

My keyboard backlight does not work

Problem: What should I do if my keyboard backlight does not work?

Solution: If your keyboard backlight does not work, try the following solutions one by one to troubleshoot and fix the issue:

1. Turn on or adjust the keyboard backlight by pressing the key combination Fn+space.
2. Update the keyboard driver. Take the following steps:
 - a. Type **device manager** in the Windows search box and then press Enter.
 - b. Click **Device Manager** from the list of results. The Device Manager window opens.
 - c. Click arrow icon > next to **Keyboard** to expand the section.
 - d. Right-click the keyboard you would like to update.
 - e. Select **Update driver** and follow the on-screen instructions.



If the problem persists, do not hesitate to call Lenovo Customer Center. For the latest Lenovo Support phone numbers for your country or region, go to <https://pcsupport.lenovo.com/supportphonenumberlist>.

Battery problems

My computer battery discharges quickly

Problem: What should I do if my computer battery discharges quickly?

Solution: If your computer battery discharges quickly, try the following solutions one by one to troubleshoot and fix the issue:

1. Terminate any power-consuming settings, operations, or running apps, such as:
 - Decrease the screen brightness.
 - Turn off the keyboard backlight.
 - Disconnect unnecessary peripheral devices.
2. Ensure your computer is not set to high performance mode, which can consume more power. Take the following steps:
 - a. Click the quick settings area    on the right side of the taskbar.
 - b. Click the battery icon to change the settings.
3. Reset the battery gauge, which can help estimate the full charge capacity more accurately. Take the following steps:
 - a. Open the Vantage app, and then click **Device → Power**.
 - b. Follow the on-screen instructions to reset the battery gauge.
4. Update the battery driver to the latest version. For details, refer to “Driver problems” in this *User Guide*.
5. If your computer battery is old or drained, consider replacing the battery.

If the problem persists, do not hesitate to call Lenovo Customer Center. For the latest Lenovo Support phone numbers for your country or region, go to <https://pcsupport.lenovo.com/supportphonenumberlist>

My computer battery icon disappears

Problem: What to do if the battery icon in the quick settings area disappeared?

Solution: If the battery icon in the quick settings area disappeared, try the following solutions one by one to troubleshoot and fix the issue:

1. Ensure that the ac power adapter, power cord, power connector, and the power outlet are working correctly.
2. Restart the computer.
3. Reset the computer. Remove the ac power adapter and take the following steps:
 - For models with an emergency reset hole, insert a straightened paper clip into the emergency reset hole. Then, restart the computer with ac power connected.
 - For models without an emergency reset hole, press and hold the power button for about seven seconds. Then, restart the computer with ac power connected.
4. Update the battery driver to the latest version. For details, refer to “Driver problems” in this *User Guide*.
5. Update UEFI BIOS to the latest version. For details, refer to “UEFI BIOS problems” in this *User Guide*.

If the problem persists, do not hesitate to call Lenovo Customer Center. For the latest Lenovo Support phone numbers for your country or region, go to <https://pcsupport.lenovo.com/supportphonenumber>.

My computer battery is not recognized

Problem: What should I do if my computer battery is not recognized?

Solution: If your computer battery is not recognized, try the following solutions one by one to troubleshoot and fix the issue:

1. Ensure that the ac power adapter, power cord, power connector, and the power outlet are working correctly.
2. Restart the computer.
3. Reset the computer. Remove the ac power adapter and take the following steps:
 - For models with an emergency reset hole, insert a straightened paper clip into the emergency reset hole. Then, restart the computer with ac power connected.
 - For models without an emergency reset hole, press and hold the power button for about seven seconds. Then, restart the computer with ac power connected.
4. Update the battery driver to the latest version. For details, refer to “Driver problems” in this *User Guide*.
5. Update UEFI BIOS to the latest version. For details, refer to “UEFI BIOS problems” in this *User Guide*.

If the problem persists, do not hesitate to call Lenovo Customer Center. For the latest Lenovo Support phone numbers for your country or region, go to <https://pcsupport.lenovo.com/supportphonenumber>.

Battery calibration issues

Problem: How to troubleshoot battery calibration issues?

Solution: To troubleshoot battery calibration issues, try the following solutions one by one:

1. Update the UEFI BIOS to the latest version. For details, refer to “UEFI BIOS problems” in this *User Guide*.
2. Reset the battery. Take the following steps:

- a. Type **device manager** in the Windows search box and then press Enter.
 - b. Click **Device Manager** from the list of results. The Device Manager window opens.
 - c. Click the arrow icon > next to **Batteries** to expand the section.
 - d. Right click **Microsoft ACPI-Compliant Control Method Battery**.
 - e. Select **Uninstall device** and follow the on-screen instructions.
 - f. Turn off the computer and disconnect the computer from ac power and all connected cables.
 - g. Remove the battery (if removable) and reinstall the battery after a few minutes. For details, refer to “CRU replacement” in this *User Guide*.
 - h. Wait for the driver to be reinstalled automatically.
3. Run Lenovo Diagnostics. Take the following steps:
- a. Restart the computer. When the logo screen is displayed, enter the UEFI BIOS menu in one of the following ways depending on your computer model:
 - For ThinkPad and ThinkBook computers: Press F1.
 - For Yoga and IdeaPad computers: Press F2.
 - b. Select **Diagnostics** or **Lenovo Diagnostics** and run a battery test to check for hardware issues.
 - c. Follow on-screen instructions to fix the issue.

If the problem persists, do not hesitate to call Lenovo Customer Center. For the latest Lenovo Support phone numbers for your country or region, go to <https://pcsupport.lenovo.com/supportphonenumber>.

My computer has no power

Problem: What should I do if my computer has no power?

Solution: If your computer has no power, try the following solutions one by one to troubleshoot and fix the issue:

1. Ensure that your computer is charged.
2. Ensure that the ac power adapter, the power cord, the power connector, and the power outlet are working correctly.
3. Reset the power. Take the following steps:
 - a. Disconnect the computer from ac power and all connected cables.
 - b. Press and hold the power button for about 30 seconds to drain any residual power.
 - c. Plug the charger back in and try turning on the computer.
4. Reset the computer (for models with an emergency reset hole). Take the following steps:
 - a. Insert a straightened paper clip into the emergency reset hole.
 - b. Restart the computer with ac power connected.
5. Remove the battery (if removable). Take the following steps:
 - a. Remove the battery. For details, refer to “CRU replacement” in this *User Guide*.
 - b. Connect the computer to ac power and try turning on the computer.

If the problem persists, do not hesitate to call Lenovo Customer Center. For the latest Lenovo Support phone numbers for your country or region, go to <https://pcsupport.lenovo.com/supportphonenumber>.

Display problems

Blue screen

Problem: How to troubleshoot blue screen errors?

Solution: To troubleshoot blue screen errors, take the following steps:

1. Type **get help** in the Windows search box and then press Enter.
2. In the search box of the Get Help app, type **troubleshoot BSOD error**.
3. Follow the guided walkthrough.

If the problem persists, do not hesitate to call Lenovo Customer Center. For the latest Lenovo Support phone numbers for your country or region, go to <https://pcsupport.lenovo.com/supportphonenumber>.

Black screen

Problem: How to troubleshoot black screen issues?

Solution: To troubleshoot black screen errors, try the following solutions one by one:

1. Update the Windows operating system. Take the following steps:
 - a. Press the Windows logo key+Ctrl+Shift+B to wake your computer from the black screen.
 - b. Select the Start menu on the taskbar and then select **Settings**.
 - c. Select **Windows Updates** and then select **Check for updates**. If updates are available, download and install them.
2. Update the mouse and keyboard drivers. Take the following steps:
 - a. Press the Windows logo key+Ctrl+Shift+B to wake your computer from the black screen.
 - b. Type **device manager** in the Windows search box and then press Enter.
 - c. Under **Keyboards**, select **HID Keyboard Device**.
 - d. Select the **Power Management** tab and then check **Allow this device to wake the computer**.
 - e. Under **Keyboards**, select **HID Keyboard Device**, and then select **Update driver**.
 - f. Select **Search automatically for drivers** and then follow the on-screen instructions to confirm the best available driver is installed.

Note: If there is more than one HID keyboard device listed, perform steps c-f for each device.

- g. Repeat steps c-f for **Mice and other pointing devices**.

Note: If there is more than one HID-compliant mouse device listed, perform steps c-f for each device.

If the problem persists, do not hesitate to call Lenovo Customer Center. For the latest Lenovo Support phone numbers for your country or region, go to <https://pcsupport.lenovo.com/supportphonenumber>.

Screen flickering

Problem: What should I do if my screen flickers?

Solution: If your screen flickers, take the following steps:

1. Check whether Task Manager also flickers. To open Task Manager, press Ctrl+Alt+Delete or Ctrl+Shift+Esc.
2. If Task Manager also flickers, roll back your display driver. Take the following steps:
 - a. Type **device manager** in the Windows search box and then press Enter.
 - b. Under **Display adapters**, select a display adapter.
 - c. Click the **Driver** tab and then select **Roll Back Driver**.
 - d. Click **Yes** to roll back your display driver and restart your computer.

Note: If the **Roll Back Driver** option is unavailable, Windows does not have a previous driver to roll back to. In this scenario, you can try updating or uninstalling your display driver in the **Driver** tab.

3. If Task Manager does not flicker, update or uninstall incompatible apps that are probably causing the problem. Take the following steps:
 - a. Keep all apps updated from the Microsoft Store or the manufacturer's site.
 - b. Check whether screen flickers in a specific app. If yes, uninstall the app. Take the following steps:
 - 1) Click the Start menu on the taskbar and then select **Settings**.
 - 2) Click **Apps** → **Installed apps**.
 - 3) Scroll down the list, find the app you want to uninstall, and then click **Uninstall**.
 - 4) In the popup window, select **Uninstall**.
 - 5) If you're asked to confirm your choice, select **Yes**.

If the problem persists, do not hesitate to call Lenovo Customer Center. For the latest Lenovo Support phone numbers for your country or region, go to <https://pcsupport.lenovo.com/supportphonenumberlist>.

The external display does not work

Problem: What should I do if the external display does not work?

Solution: If the external display does not work, try the following solutions one by one to troubleshoot and fix the issue:



1. Ensure that the external display is well connected to your computer
2. Reconnect the external display to your computer.
3. Update the display driver. Take the following steps:
 - a. Type **device manager** in the Windows search box and then press Enter.
 - b. Click the arrow icon > next to **Display adapters** to expand the section.
 - c. Right-click your display adapter, select **Update driver**, and follow the on-screen instructions.
4. Roll back to the previous installed driver if the display problem occurs after a recent driver update. Take the following steps:
 - a. Type **device manager** in the Windows search box and then press Enter.
 - b. Click the arrow icon > next to **Display adapters** to expand the section.
 - c. Right-click the display driver and select **Properties**.
 - d. Under **Driver**, select **Roll Back Driver** and follow the on-screen instructions.

If the problem persists, do not hesitate to call Lenovo Customer Center. For the latest Lenovo Support phone numbers for your country or region, go to <https://pcsupport.lenovo.com/supportphonenumberlist>.

The display remains dim

Problem: What should I do if the display remains dim?

Solution: If the display remains dim, try the following solutions one by one to troubleshoot and fix the issue:

1. Adjust the display brightness. Choose one of the following ways:
 - Press the function key F6 to increase the display brightness.
 - Go to **Start → Settings → System → Display**, and move the **Brightness** slider to the right.
 - Click the quick settings area    on the right side of the taskbar to open the quick settings panel, and then move the **Brightness** slider to the right.
2. Update the display driver. Take the following steps:
 - a. Type **device manager** in the Windows search box and then press Enter.
 - b. Click the arrow icon > next to **Display adapters** to expand the section.
 - c. Right-click your display adapter, select **Update driver**, and follow the on-screen instructions.
3. Roll back to the previous installed driver if the problem occurs after a recent driver update. Take the following steps:
 - a. Type **device manager** in the Windows search box and then press Enter.
 - b. Click the arrow icon > next to **Display adapters** to expand the section.
 - c. Right-click the display driver and select **Properties**.
 - d. Under **Driver**, select **Roll Back Driver** and follow the on-screen instructions.

If the problem persists, do not hesitate to call Lenovo Customer Center. For the latest Lenovo Support phone numbers for your country or region, go to <https://pcsupport.lenovo.com/supportphonenumber>.

Customize my display settings

Problem: How to customize my display settings?

Solution: To optimize your display settings, try the following solutions one by one:

1. Press the function keys F5 or F6 to adjust the display brightness.
2. Adjust the scale and display resolution. Take the following steps:
 - a. Type **display settings** in the Windows search box and then press Enter.
 - b. Under **Scale & layout**, select the recommended scale and display resolution.
3. Calibrate the display color. Take the following steps:
 - a. Type **calibrate display color** in the Windows search box and then press Enter.
 - b. Follow the on-screen instructions to adjust your display's color settings.
4. Enable HDR settings to have a more vibrant colors in videos or apps. Take the following steps:
 - a. Type **display settings** in the Windows search box and then press Enter.
 - b. Under **Brightness & color**, enable HDR settings.

If the problem persists, do not hesitate to call Lenovo Customer Center. For the latest Lenovo Support phone numbers for your country or region, go to <https://pcsupport.lenovo.com/supportphonenumber>.

Set my computer's screen resolution

Problem: How to set my computer's screen resolution?

Solution: To set your computer's screen resolution, try the following solutions one by one:

1. Check display settings. Take the following steps:
 - a. Type **display settings** in the Windows search box and then press Enter.
 - b. Under **Display resolution**, select the recommended resolution.
2. Update graphics drivers. Take the following steps:
 - a. Type **device manager** in the Windows search box and then press Enter.
 - b. Under **Display adapters**, right-click your display adapter and select **Update driver**.
 - c. Click **Search automatically for drivers** to update graphics driver automatically.
3. Roll back graphics drivers. Take the following steps:
 - a. Type **device manager** in the Windows search box and then press Enter.
 - b. Under **Display adapters**, right-click your display adapter and select **Properties**.
 - c. Go to **Driver** tab and click **Roll Back Driver** if the option is available.
4. Reinstall graphics drivers. Take the following steps:
 - a. Type **device manager** in the Windows search box and then press Enter.
 - b. Under **Display adapters**, right-click your display adapter and select **Uninstall device**.
 - c. Restart your computer to reinstall the correct driver.
5. Upgrade the Windows operating system. Take the following steps:
 - a. Type **Windows update** in the Windows search box and press Enter.
 - b. Click **Check for updates**. If an operating system update package is available, it will be automatically downloaded and installed.
 - c. Follow the on-screen instructions to install the device drivers and necessary programs.

If the problem persists, do not hesitate to call Lenovo Customer Center. For the latest Lenovo Support phone numbers for your country or region, go to <https://pcsupport.lenovo.com/supportphonenumber>.

Fingerprint reader problems

Fingerprint recognition cannot be set up

Problem: What should I do if I cannot set up fingerprint recognition?

Solution: If you cannot set up fingerprint recognition, try the following solutions one by one to troubleshoot and fix the issue:

1. Restart the computer.
2. Cut off power supply to the fingerprint reader temporarily. Remove the ac power adapter and take the following steps:
 - For models with an emergency reset hole, insert a straightened paper clip into the emergency reset hole. Then, restart the computer with ac power connected.
 - For models without an emergency reset hole, press and hold the power button for about seven seconds. Then, restart the computer with ac power connected.
3. Check the fingerprint device driver. Take the following steps:
 - a. Type **device manager** in the Windows search box.
 - b. Click **Device Manager** from the list of results. The Device Manager window opens.

- c. Click the arrow icon > next to **Biometric devices** to expand the section.
 - If there is no fingerprint device, it might be a fingerprint reader failing problem, and you might need to have the fingerprint reader serviced.
 - If there is a yellow exclamation mark next to the fingerprint device, update the fingerprint reader driver. Take the following steps:
 - 1) Download the latest driver from Lenovo support website. For how to download the driver, refer to “Driver problems” in this *User Guide*.
 - 2) In the **Biometric devices** section of the Device manager, right-click the fingerprint device, and then click **Update driver**.
 - 3) In the Update Drivers window, click **Browse my computer for drivers**.
 - 4) Browse to the folder where the latest fingerprint driver is stored. Double-click to run the driver and then follow the on-screen instructions to update the driver.
 - 5) Restart your computer.

If the problem persists, do not hesitate to call Lenovo Customer Center. For the latest Lenovo Support phone numbers for your country or region, go to <https://pcsupport.lenovo.com/supportphonenumber>.

Fingerprint recognition error

Problem: What should I do if fingerprint recognition always fails?

Solution: If fingerprint recognition always fails, try the following solutions one by one to troubleshoot and fix the issue:

1. Remove the fingerprint, and enroll again. Take the following steps:
 - a. Click **Start → Settings → Accounts → Sign-in options → Fingerprint recognition (Windows Hello)**.
 - b. Click **Remove** to remove the fingerprint. No matter how many fingers have been set, you only need to remove once.
 - c. Enroll the fingerprint again. For how to enroll the fingerprint, refer to fingerprint recognition topic in this *User Guide*.

Note: During the enrollment, it is recommended that you follow the on-screen instructions to enroll the full image of your fingerprint.
2. Update the fingerprint driver and enroll again. Take the following steps:
 - a. Download the latest driver from Lenovo support website. For how to download the driver, refer to “Driver problems” in this *User Guide*.
 - b. Remove the fingerprint. Take the following steps:
 - 1) Click **Start → Settings → Accounts → Sign-in options → Fingerprint recognition (Windows Hello)**.
 - 2) Click **Remove** to remove the fingerprint. No matter how many fingers have been set, you only need to remove once.
 - c. Update the fingerprint driver. Take the following steps:
 - 1) Type **device manager** in the Windows search box.
 - 2) Click **Device Manager** from the list of results. The Device Manager window opens.
 - 3) Click the arrow icon > next to **Biometric devices** to expand the section.
 - 4) Right-click the fingerprint driver, and then click **Update driver**.

- 5) Browse to the folder where the latest fingerprint driver is stored. Double-click to run the driver and then follow the on-screen instructions to update the driver.
 - 6) Restart your computer.
- d. Enroll the fingerprint again. For how to enroll the fingerprint, refer to fingerprint recognition topic in this *User Guide*.

Note: During the enrollment, it is recommended that you follow the on-screen instructions to enroll the full image of your fingerprint.

If the problem persists, do not hesitate to call Lenovo Customer Center. For the latest Lenovo Support phone numbers for your country or region, go to <https://pcsupport.lenovo.com/supportphonenumber>.

Fingerprint enrollment error

Problem: What should I do if there is an error during fingerprint enrollment?

Solution: If there is an error during fingerprint enrollment, try the following solutions one by one to troubleshoot and fix the issue:

1. Download the latest driver from Lenovo support website. For how to download the driver, refer to “Driver problems” in this *User Guide*.
2. Update the fingerprint reader driver. Take the following steps:
 - a. Type **device manager** in the Windows search box.
 - b. Click **Device Manager** from the list of results. The Device Manager window opens.
 - c. Click the arrow icon > next to **Biometric devices** to expand the section.
 - d. Right-click the fingerprint driver, and then click **Update driver**.
 - e. In the Update Drivers window, click **Browse my computer for drivers**.
 - f. Browse to the folder where the latest fingerprint driver is stored. Double-click to run the driver and then follow the on-screen instructions to update the driver.
3. Restart your computer, and then enroll again.

If the problem persists, do not hesitate to call Lenovo Customer Center. For the latest Lenovo Support phone numbers for your country or region, go to <https://pcsupport.lenovo.com/supportphonenumber>.

Touchpad or trackpad problems

My touchpad or trackpad does not respond

Problem: What should I do if my touchpad or trackpad does not respond?

Solution: If your touchpad or trackpad is not responding, try the following solutions one by one to troubleshoot and fix the issue:

1. Enable the touchpad. Take the following steps:
 - a. Go to **Start → Settings → Bluetooth & devices → Touchpad**.
 - b. Turn on the **Touchpad** toggle.

Note: For some Lenovo computers, you can also press the touchpad hotkey  or the key combination Fn+M to enable or disable the touchpad.

2. Update the touchpad driver. Take the following steps:
 - a. Type **device Manager** in the Windows search box and then press Enter.
 - b. Click the arrow next to **Human Interface Devices** to expand the section.
 - c. Right-click the touchpad, select **Update driver**, and follow the on-screen instructions.
3. Roll back the touchpad driver. Take the following steps:
 - a. Type **device Manager** in the Windows search box and then press Enter.
 - b. Click the arrow icon > next to **Human Interface Devices** to expand the section.
 - c. Right-click the touchpad, and select **Properties**.
 - d. Under **Driver**, select **Roll Back Driver** and follow the on-screen instructions.

If the problem persists, do not hesitate to call Lenovo Customer Center. For the latest Lenovo Support phone numbers for your country or region, go to <https://pcsupport.lenovo.com/supportphonenumberlist>.

My touchpad or trackpad responds slowly

Problem: What should I do if my touchpad or trackpad responds slowly?

Solution: If your touchpad or trackpad response is very slow, take the following steps to troubleshoot and fix the issue:

1. Go to **Start → Settings → Bluetooth & devices → Touchpad**.
2. Adjust the cursor speed.
3. Under **Taps**, adjust the touchpad or trackpad sensitivity.

If the problem persists, do not hesitate to call Lenovo Customer Center. For the latest Lenovo Support phone numbers for your country or region, go to <https://pcsupport.lenovo.com/supportphonenumberlist>.

TrackPoint problems

My TrackPoint pointing device does not respond

Problem: What should I do if my TrackPoint pointing device does not respond?

Solution: If your TrackPoint pointing device does not respond, try the following solutions one by one to troubleshoot and fix the issue:

1. Ensure that there is no visible damage on the TrackPoint pointing device.
2. Ensure that the TrackPoint pointing device is enabled. Take the following steps:
 - a. Open the Start menu, and then click **Settings → Bluetooth & devices → Mouse → TrackPoint settings**.
 - b. Ensure that the toggle is set to **On** and **Leave Trackpoint on when a mouse is connected** is selected.
3. Update the TrackPoint driver. Take the following steps:
 - a. Type **device manager** in Windows search box and then press Enter.
 - b. Click the arrow icon > next to **Mice and other pointing devices** to expand the section.
 - c. Right-click the TrackPoint pointing device that is malfunctioning, and then select **Update Driver**.
 - d. In the pop-up window, select **Search automatically for drivers**.
4. Uninstall the TrackPoint driver. Take the following steps:
 - a. Type **device manager** in Windows search box and then press Enter.

- b. Click the arrow icon > next to **Mice and other pointing devices** to expand the section.
 - c. Right-click on the TrackPoint pointing device that is malfunctioning, and then select **Uninstall device**.
 - d. Confirm that you want to uninstall this device from your system in the Uninstall Device window, and then click **Uninstall**.
 - e. After the driver is uninstalled, restart your computer. Windows will automatically install the latest driver.
5. Ensure that the TrackPoint pointing device is enabled in the UEFI BIOS setting. Take the following steps:
 - a. Restart the computer. When the logo screen is displayed, press F1 to enter the UEFI BIOS menu.
 - b. Select **Config → Keyboard/Mouse**, then turn on the **TrackPoint** switch.

If the problem persists, do not hesitate to call Lenovo Customer Center. For the latest Lenovo Support phone numbers for your country or region, go to <https://pcsupport.lenovo.com/supportphonenumberlist>.

Touch screen problems

My touch screen does not respond

Problem: What should I do if my touch screen does not respond?

Solution: If your touch screen does not respond, try the following solutions one by one to troubleshoot and fix the issue:

1. Clean your touch screen. Take the following steps:
 - a. Turn off the computer.
 - b. Use a dry, soft, and lint-free cloth or a piece of absorbent cotton to remove fingerprints or dust from the touch screen. Do not apply solvents to the cloth.
 - c. Restart the computer.
2. Enable your touch screen. Take the following steps:
 - a. Type **device manager** in the Windows search box and then press Enter.
 - b. Under **Human Interface Devices**, right-click **HID-compliant touch screen**.
 - c. Select the **Driver** tab, select **Enable device**, and then confirm.

Note: If there's more than one HID-compliant touch screen device listed, perform steps b-c for each device.

 - d. If **Intel(R) Quick I2C Host Controller** is listed under **Human Interface Devices**, right-click **Intel(R) Quick I2C Host Controller**, select **Driver → Enable device**, and then confirm.

Note: If there is more than one Intel(R) Quick I2C Host Controller device listed, perform step d for each device.
3. Update your touch screen driver. Take the following steps:
 - a. Type **device manager** in the Windows search box and then press Enter.
 - b. Under **Human Interface Devices**, right-click **HID-compliant touch screen**.
 - c. Select the **Driver** tab and then select **Update Driver**.
 - d. Select **Search automatically for drivers** and then follow the on-screen instructions to confirm the best available driver is installed.

Note: If there is more than one HID-compliant touch screen device listed, perform steps b-d for each device.

- e. If **Intel(R) Quick I2C Host Controller** is listed under **Human Interface Devices**, right-click **Intel(R) Quick I2C Host Controller**, select **Driver** → **Update Driver** → **Search automatically for drivers**, and then follow the on-screen instructions to confirm the best available driver is installed.

Note: If there is more than one Intel(R) Quick I2C Host Controller device listed, perform step e for each device.

4. Upgrade the Windows operating system. Take the following steps:
 - a. Type **windows update** in the Windows search box and press Enter.
 - b. Click **Check for updates**. If an operating system update package is available, it will be automatically downloaded and installed.
 - c. Follow the on-screen instructions to install the device drivers and necessary programs.

If the problem persists, do not hesitate to call Lenovo Customer Center. For the latest Lenovo Support phone numbers for your country or region, go to <https://pcsupport.lenovo.com/supportphonenumber>.

Fan problems

Loud fan noise

Problem: What should I do if my fan makes loud noise?

Solution: If your fan makes loud noise, try the following solutions one by one to troubleshoot and fix the issue:

1. Terminate power-consuming applications or processes that are not in use to reduce fan noises. Take the following steps:
 - a. Type **task manager** in the Windows search box and press Enter.
 - b. Terminate power-consuming applications or processes that are not in use.
2. Adjust your computer operation mode to the proper one. Choose one of the following solutions:
 - For computer models with the intelligent cooling feature, power efficiency mode or balanced mode is preferred. For details, see “Intelligent cooling” in this *User Guide*.
 - For computer models with the system operation modes feature, power saving (quiet) mode or auto (balanced) mode is preferred. For details, see “System operation modes” in this *User Guide*.
3. Update the operating system or device drivers to the latest version. For details, see “OS problems” or “Driver problems” in this *User Guide*.

If the problem persists, do not hesitate to call Lenovo Customer Center. For the latest Lenovo Support phone numbers for your country or region, go to <https://pcsupport.lenovo.com/supportphonenumber>.

Computer overheating

Problem: What should I do if my computer is overheating?

Solution: If your computer is overheating, try the following solutions one by one to troubleshoot and fix the issue:

1. Improve airflow. Ensure that the vents of your computer are not covered and there is enough airflow to keep the computer cool. Avoid using the computer on a soft surface, such as a bed or couch. It is recommended to use the computer on a table or lap desk in a cool room.

2. Adjust your computer operation mode to the proper one. Choose one of the following solutions:
 - For computer models with the intelligent cooling feature, power efficiency mode or balanced mode is preferred. For details, see “Intelligent cooling” in this *User Guide*.
 - For computer models with the system operation modes feature, power saving (quiet) mode or auto (balanced) mode is preferred. For details, see “System operation modes” in this *User Guide*.
3. If the issue is still not fixed, terminate power-consuming applications or processes that are not in use to reduce heat. Take the following steps:
 - a. Type **task manager** in the Windows search box and press Enter.
 - b. Terminate power-consuming applications or processes that are not in use.

If the problem persists, do not hesitate to call Lenovo Customer Center. For the latest Lenovo Support phone numbers for your country or region, go to <https://pcsupport.lenovo.com/supportphonenumber>.

My computer fan runs constantly

Problem: What should I do if my computer fan runs constantly?

Solution: If your fan runs constantly, try the following solutions one by one to troubleshoot and fix the issue:

1. Terminate power-consuming applications or processes that are not in use to reduce heat. Take the following steps:
 - a. Type **task manager** in the Windows search box and press Enter.
 - b. Terminate power-consuming applications or processes that are not in use.
2. Adjust your computer operation mode to the proper one. Choose one of the following solutions:
 - For computer models with the intelligent cooling feature, power efficiency mode or balanced mode is preferred. For details, see “Intelligent cooling” in this *User Guide*.
 - For computer models with the system operation modes feature, power saving (quiet) mode or auto (balanced) mode is preferred. For details, see “System operation modes” in this *User Guide*.
3. Improve airflow. Ensure that the vents of your computer are not covered and there is enough airflow to keep the computer cool. Avoid using the computer on a soft surface, such as a bed or couch. It is recommended to use the computer on a table or lap desk in a cool room.
4. Clean the air vents or dust filters. Take the following steps:
 - a. Turn off the computer and disconnect the computer from ac power and all connected cables.
 - b. Use compressed air to blow out the dirt and debris from the air vent or dust filter.
5. Update the UEFI BIOS or device drivers to the latest version. For details, see “UEFI BIOS problems” or “Driver problems” in this *User Guide*.

If the problem persists, do not hesitate to call Lenovo Customer Center. For the latest Lenovo Support phone numbers for your country or region, go to <https://pcsupport.lenovo.com/supportphonenumber>.

External devices problems

My HDMI port does not work

Problem: What should I do if my HDMI port does not work?

Solution: To fix HDMI port issues on your computer, try the following solutions one by one:

1. Ensure the HDMI cable is securely connected to both your computer and external devices.

2. Try using a different HDMI cable or port if available. If there are any visible damages of your HDMI cable, you can purchase a new HDMI cable at <https://www.lenovo.com/accessories>.
3. Update graphics drivers. Take the following steps:
 - a. Type **device manager** in the Windows search box and then press Enter.
 - b. Under **Display adapters**, right-click your display adapter and select **Update driver**.
 - c. Click **Search automatically for drivers** to update graphics driver automatically.
4. Upgrade the Windows operating system. Take the following steps:
 - a. Type **windows update** in the Windows search box and press Enter.
 - b. Click **Check for updates**. If an operating system update package is available, it will be automatically downloaded and installed.
 - c. Follow the on-screen instructions to install the device drivers and necessary programs.

If the problem persists, do not hesitate to call Lenovo Customer Center. For the latest Lenovo Support phone numbers for your country or region, go to <https://pcsupport.lenovo.com/supportphonenumberlist>.

Docking station problems

Poor docking station connection

Problem: What should I do if my docking station has a poor connection?

Solution: If your docking station has a poor connection, try the following solutions one by one to troubleshoot and fix the issue:

1. Ensure that your computer is compatible with the docking station. To check the compatibility, go to <https://www.lenovo.com/accessoriesguide>.
2. Use a dry, soft, and lint-free cloth or a piece of absorbent cotton to remove dust from the connectors on the docking station.
3. Use the cable that comes with your computer or the docking station, and ensure it is completely and firmly connected to both devices. If there are any visible signs of damage, you can purchase a new cable at <https://www.lenovo.com/accessories>.

Note: If your docking station has a LED indicator, ensure that it turns to solid white. If not, disconnect the cable and wait 15 seconds. Then, reconnect it to the docking station.

4. Restart your computer to establish a new connection to the docking station.

If the problem persists, do not hesitate to call Lenovo Customer Center. For the latest Lenovo Support phone numbers for your country or region, go to <https://pcsupport.lenovo.com/supportphonenumberlist>.

My docking station is well connected but does not work

Problem: What should I do if my docking station is well connected but does not work?

Solution: If your docking station is well connected but does not work, try the following solutions one by one to troubleshoot and fix the issue:

1. Update the driver to the latest version. For details, refer to “Driver problems” in this *User Guide*.
2. Update the firmware. Take the following steps:
 - a. Go to <https://pcsupport.lenovo.com> and search by your docking station name.

- b. Select and download the update package you want under **Drivers and Software** or **Drivers and Firmware** tab.
- c. Follow the on-screen instructions to manually install the firmware.

Note: The firmware packages might not be available depending on the docking station.

3. If the issue is still not fixed, update the UEFI BIOS to the latest version. For details, refer to “UEFI BIOS problems” in this *User Guide*.

If the problem persists, do not hesitate to call Lenovo Customer Center. For the latest Lenovo Support phone numbers for your country or region, go to <https://pcsupport.lenovo.com/supportphonenumberlist>.

Hinge problems

My computer hinges lose torque

Problem: What should I do if my computer hinges lose torque?

Solution: If your computer hinges lose torque, take the following steps:

1. Go to <https://support.lenovo.com/partnerlocator> to locate the nearest service center.
2. Go to a service center in your area for professional support.

If the problem persists, do not hesitate to call Lenovo Customer Center. For the latest Lenovo Support phone numbers for your country or region, go to <https://pcsupport.lenovo.com/supportphonenumberlist>.

My computer cannot be opened or closed

Problem: What should I do if I cannot open or close the computer?

Solution: If you cannot open or close the computer, do not forcibly operate it. Otherwise, other components might be damaged. Take the following steps:

1. Go to <https://support.lenovo.com/partnerlocator> to locate the nearest service center.
2. Go to a service center in your area for professional support.

If the problem persists, do not hesitate to call Lenovo Customer Center. For the latest Lenovo Support phone numbers for your country or region, go to <https://pcsupport.lenovo.com/supportphonenumberlist>.

Pen problems



My pen is not detected or does not work

Problem: What should I do if my pen is not detected or does not work?

Solution: If your pen is not detected or does not work, try the following solutions one by one to troubleshoot and fix the issue:

1. Charge the pen.

Note: The charging time might vary depending on pen types.

2. Establish Bluetooth connection between your pen and your computer properly. Take the following steps:
 - a. Click the quick settings area    on the right side of taskbar.
 - b. Click the Bluetooth settings and turn on the Bluetooth.

- c. Select the pen in the list displayed and follow on-screen instructions.
3. Update **Lenovo Pen Settings**, an app preinstalled on your computer, and ensure that your pen has paired to your computer through Bluetooth.

If the problem persists, do not hesitate to call Lenovo Customer Center. For the latest Lenovo Support phone numbers for your country or region, go to <https://pcsupport.lenovo.com/supportphonenumber>.

USB problems

My USB connector does not work

Problem: What should I do if my USB connector does not work?

Solution: If your USB connector does not work, try the following solutions one by one to troubleshoot and fix the issue:

1. Ensure that the cable is connected properly to your computer or there are no debris in your USB connector.
2. Use a different USB connector on your computer.
3. Ensure that your USB connector supports charging function if you are using a USB connector for charging.
4. Disable **USB selective suspend setting**. Take the following steps:
 - a. Type **power plan** in the Windows search box and press Enter.
 - b. Click **Edit power plan → Change advanced power settings**.
 - c. Double-click **USB settings → USB selective suspend setting** to expand the menu.
 - d. Disable **On battery** and **Plugged in** and click **Apply**.
 - e. Restart your computer.
5. Restart your computer.
6. Update the driver. Take the following steps:
 - a. Type **device manager** in the Windows search box and then press Enter.
 - b. Click **Device Manager** from the list of results. The Device Manager window opens.
 - c. Click the arrow icon > next to **Universal Serial Bus controllers** to expand the section.
 - d. Right-click the USB device you would like to update.
 - e. Select **Update driver** and follow the on-screen instructions.

If the problem persists, do not hesitate to call Lenovo Customer Center. For the latest Lenovo Support phone numbers for your country or region, go to <https://pcsupport.lenovo.com/supportphonenumber>.

Recover data from a USB drive

Problem: How to recover data from a USB drive?

Solution: To recover data from a USB drive, choose one of the following solutions to troubleshoot and fix the issue:

- Recover data by using command lines. Take the following steps:
 1. Connect the USB drive to your computer.
 2. Press Windows key+R to launch Windows Explorer.

3. Type **CMD** in the search box and press Enter.
4. Type **chkdsk E: /f** and press Enter.

Note: Replace E with your actual USB drive letter.

5. Type **ATTRIB -H -R -S /S /D E:*.*** and press Enter.

Note: Replace E with your actual USB drive letter.

6. Wait for the process to finish.

All the recovered files will be in a new folder on your USB drive after the process is complete.

Note: These files names might be with the extension “.chk”. You can change it into the original extension, for example, “.jpg” , and save the files to another location.

- If you have created a recovery USB drive as a backup for the Windows recovery programs, recover data by restoring to a previous version. Take the following steps:
 1. Connect the USB drive to your computer and enter **This PC**.
 2. Right-click your USB drive and select **Properties**.
 3. Click **Previous Versions** and select an available previous version.
 4. Click **Restore to** and choose a new location to save the files.
- Recover data by using a reliable USB data recovery tool.

If the problem persists, do not hesitate to call Lenovo Customer Center. For the latest Lenovo Support phone numbers for your country or region, go to <https://pcsupport.lenovo.com/supportphonenumberlist>.

Create a recovery drive

Problem: How to create a recovery drive?

Solution: To create a recovery drive, take the following steps:

Attention: The process of creating a recovery drive deletes all the data stored on the USB drive, including the data stored in a hidden folder.

1. Prepare a USB drive (at least 32 GB of storage).
2. Type **Create a recovery drive** in the Windows search box and then select it.
3. Ensure that **Back up system files to the recovery drive** is selected and then click **Next**.
4. Connect the USB drive to your computer, select it and then click **Next**.
5. Click **Create** to start the recovery drive creation process.

If the problem persists, do not hesitate to call Lenovo Customer Center. For the latest Lenovo Support phone numbers for your country or region, go to <https://pcsupport.lenovo.com/supportphonenumberlist>.

Copilot key problems

Windows Copilot is not launched by pressing the Copilot key

Problem: What should I do if I cannot open Copilot in Windows by pressing the Copilot key on the keyboard?

Solution: If you cannot open Copilot in Windows by pressing the Copilot key on the keyboard, try the following solutions one by one to troubleshoot and fix the issue:

1. Check whether your country or region supports the function. Copilot in Windows is available in selected global markets. If the Windows Search opens after you press the Copilot key , it means your country or region does not support the function.
2. Update your Windows operating system to 23H2 or later version.



If the problem persists, do not hesitate to call Lenovo Customer Center. For the latest Lenovo Support phone numbers for your country or region, go to <https://pcsupport.lenovo.com/supportphonenumber>.

Bluetooth connection problems

Bluetooth connection error

Problem: What should I do if I cannot connect to Bluetooth?

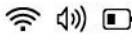
Solution: If you cannot connect to Bluetooth, try the following solutions one by one to troubleshoot and fix the issue:

1. Ensure Bluetooth is supported and enabled on both your computer and your Bluetooth device. To turn on Bluetooth on your computer, take the following steps:
 - a. Click the quick settings area  on the right side of the taskbar.
 - b. In the Bluetooth quick setting, ensure that Bluetooth is turned on. If not, click the Bluetooth icon to turn it on.
2. Restart your Bluetooth device.
3. Ensure that your Bluetooth device is charged or has enough power.
4. Ensure that your Bluetooth device is placed within the required Bluetooth connection distance range of your computer.
5. Ensure that airplane mode is turned off on your computer. Take the following steps:
 - a. Click the quick settings area  on the right side of the taskbar.
 - b. In the Airplane mode quick setting, ensure that Airplane mode is turned off. If not, click the Airplane mode icon to turn it off.
6. Ensure that your Bluetooth device is not too close to other USB devices that are connected to your computer. Unshielded USB devices might interfere with Bluetooth connections.
7. Remove your Bluetooth device, and then add it again. Take the following steps:
 - a. Remove your Bluetooth device. Take the following steps:
 - 1) Click **Start → Settings → Bluetooth & devices → Devices**.
 - 2) Click **More options** of the Bluetooth device you are having problem with.
 - 3) Click **Remove device** to remove the Bluetooth device.
 - 4) Ensure that the Bluetooth on both your computer and the Bluetooth device are turned on. Ensure that the device is discoverable.
 - b. Add your Bluetooth device. Take the following steps:
 - 1) Click the quick settings area  on the right side of the taskbar.
 - 2) Click **Manage Bluetooth devices** (>) on the Bluetooth quick setting to expand the section.
 - 3) Click the device when it is displayed on the **New devices** list, and then follow the on-screen instructions.
8. Run the Bluetooth troubleshooter. Take the following steps:
 - a. Click **Start → Settings → System → Troubleshoot → Other troubleshooters**.

- b. Locate the Bluetooth section, click **Run** and then follow the on-screen instructions.
9. Uninstall the driver of the Bluetooth adapter. Windows will automatically install the latest driver. Take the following steps:
 - a. Type **device manager** in the Windows search box.
 - b. Click **Device Manager** from the list of results. The Device Manager window opens.
 - c. Click the arrow icon > next to **Bluetooth** to expand the section.
 - d. Right-click the Bluetooth device you are having problem with, and then click **Uninstall device**.
 - e. Confirm that you want to uninstall this device from your system in the Uninstall Device window, and then click **Uninstall**.
 - f. After the driver is uninstalled, restart your computer. Windows will automatically install the latest driver.
 - g. If Windows does not reinstall the driver automatically, open device manager and click **Action** → **Scan for hardware changes**.









If the problem persists, do not hesitate to call Lenovo Customer Center. For the latest Lenovo Support phone numbers for your country or region, go to <https://pcsupport.lenovo.com/supportphonenumberlist>.

Network connection problems

Wi-Fi connection error

Problem: What should I do if I cannot connect to Wi-Fi?

Solution: If you cannot connect to Wi-Fi, try the following solutions one by one to troubleshoot and fix the issue:

1. Ensure that Wi-Fi is turned on and Airplane mode is turned off. Take the following steps:
 - a. Click the quick settings area    on the right side of the taskbar.
 - b. Check if Wi-Fi is turned on. If not, click the Wi-Fi icon to turn it on.
 - c. Check if Airplane mode is turned off. If not, click the Airplane mode icon to turn it off.
2. Reconnect to Wi-Fi. Take the following steps:
 - a. Click the quick settings area    on the right side of the taskbar.
 - b. Click **Manage Wi-Fi connections** (>) on the Wi-Fi quick setting to expand the section.
 - c. Select the network you want to connect, and click **Connect**.
3. Connect to the network with a different frequency band. Most Wi-Fi routers support both 2.4 GHz and 5 GHz network frequency bands. They appear as two different networks in the list of Wi-Fi networks. If your list of Wi-Fi networks includes these two networks, connect to the one with different frequency band.
4. Run the network troubleshooter on your computer to diagnose and solve common network connecting problems. Take the following steps:
 - a. Right-click the network icon in the quick settings area    on the right side of the taskbar.
 - b. Click **Diagnose network problems** and follow on-screen instructions.
5. Restart your modem and wireless router. Take the following steps:
 - a. Disconnect your modem and wireless router from power source.
 - b. If your modem has a backup battery, remove the battery.
 - c. Wait for at least 30 seconds.

- d. If you had removed the backup battery from the modem, install it.
 - e. Connect your modem and wireless router to the power source.
 - f. Connect to Wi-Fi network on your computer again.
6. Disable your wireless network adapter driver and enable it again. Take the following steps:
 - a. Type **device manager** in the Windows search box.
 - b. Click **Device Manager** from the list of results. The Device Manager window opens.
 - c. Click the arrow icon > next to **Network adapters** to expand the section.
 - d. Right-click the wireless network adapter driver, and then click **Disable device**.
 - e. Click **Yes** in the window prompted. The wireless network adapter driver is disabled.
 - f. Right-click the wireless network adapter driver again, and then click **Enable device** to enable the driver.
 7. Uninstall your wireless network adapter driver and restart your computer. Take the following steps:
 - a. Before uninstalling, download the available driver on a different computer from Lenovo support website and save it to a USB flash drive. For how to download the driver, see “Driver problems” in this *User Guide*.
 - b. Type **device manager** in the Windows search box.
 - c. Click **Device Manager** from the list of results. The Device Manager window opens.
 - d. Click the arrow icon > next to **Network adapters** to expand the section.
 - e. Right-click the wireless network adapter driver, and then click **Uninstall device**.
 - f. In the Uninstall Device window, confirm that you want to uninstall this device from your system, and then click **Uninstall**.
 - g. After the driver is uninstalled, restart your computer.
 - h. Install the driver you have downloaded.
 8. Contact your Internet service provider to check if there are any issues with your internet plan or connection.

If the problem persists, do not hesitate to call Lenovo Customer Center. For the latest Lenovo Support phone numbers for your country or region, go to <https://pcsupport.lenovo.com/supportphonenumber>.

Power charging problems

My computer is not charged when connected to ac power

Problem: What should I do if my computer is connected to ac power but not charged?

Solution: If your computer is connected to ac power but not charged, try the following solutions one by one to troubleshoot and fix the issue:

1. Ensure that you use Lenovo-certified ac power adapter and power cord that are designed for charging with proper wattage. If there are any visible signs of damage, you can purchase a new ac power adapter or power cord at <https://www.lenovo.com/accessories>.
2. Ensure that the power connector is clean and well-conditioned.
3. Ensure that the power adapter and power cord are completely and firmly connected to both your computer and a working power outlet.
4. Turn off the computer and disconnect the computer from ac power and all connected cables. Wait a few minutes. Then, reconnect to ac power and turn on the computer.

If the problem persists, do not hesitate to call Lenovo Customer Center. For the latest Lenovo Support phone numbers for your country or region, go to <https://pcsupport.lenovo.com/supportphonenumberlist>.

My built-in battery cannot be charged

Problem: What should I do if my built-in battery cannot be charged?

Solution: If your built-in battery cannot be charged, try the following solutions one by one to troubleshoot and fix the issue:

1. Ensure that you use the power adapter with proper wattage. Low-wattage power adapters might cause battery charging problem.
2. Exit any heavy-loading programs and charge the computer again. To check the load of programs in process: Press Ctrl+Alt+Delete, and then click **Task Manager** → **Processes**.
3. Move your computer to a cool and well-ventilated spot. Battery charging is also affected by its temperature.
4. Reset the battery gauge. Take the following steps:
 - a. Open the Vantage app, and then click the menu icon at the top-right corner.
 - b. Select **Power** → **BATTERY SETTINGS**, and then click **RESET** in **Battery gauge reset** section.
5. Update the UEFI BIOS to the latest version. For details, refer to “UEFI BIOS problems” in this *User Guide*.

If the problem persists, do not hesitate to call Lenovo Customer Center. For the latest Lenovo Support phone numbers for your country or region, go to <https://pcsupport.lenovo.com/supportphonenumberlist>.

My built-in battery is not fully charged

Problem: What should I do if my built-in battery is not fully charged?

Solution: Keeping the battery from full charge when battery power is not in heavy use can help extend its lifespan. If you want to fully charge the battery, try the following solutions one by one:

1. Disable the Smart Charge or Conservation Mode. Take the following steps:
 - a. Open the Vantage app, and then click the menu icon at the top-right corner.
 - b. Select **Power** → **BATTERY SETTINGS**, and then slide the **Smart charge** or **Conservation Mode** switch to disable the function.
2. Reset the battery gauge. Take the following steps:
 - a. Open the Vantage app, and then click the menu icon at the top-right corner.
 - b. Select **Power** → **BATTERY SETTINGS**, and then click **RESET** in **Battery gauge reset** section.
3. Update the UEFI BIOS to the latest version. For details, refer to “UEFI BIOS problems” in this *User Guide*.

If the problem persists, do not hesitate to call Lenovo Customer Center. For the latest Lenovo Support phone numbers for your country or region, go to <https://pcsupport.lenovo.com/supportphonenumberlist>.

Startup problems

My computer does not start up

Problem: What should I do if my computer does not start up?

Solution If your computer does not start up, take the following steps:

1. Check if the power indicator is on, to ensure that the power adapter is connected to your computer and the power cord of your computer is plugged into a working electrical outlet.
2. If you are using a power strip or surge protector, ensure it is turned on and working.
3. Press the power button to turn on your computer again.

If the problem persists, do not hesitate to call Lenovo Customer Center. For the latest Lenovo Support phone numbers for your country or region, go to <https://pcsupport.lenovo.com/supportphonenumber>.

My computer starts up slowly

Problem: What should I do if my computer starts up slowly?

Solution: If your computer starts up slowly, try the following solutions one by one to troubleshoot and fix the issue:

1. Ensure that your Windows operating system and drivers are up-to-date. Take the following steps:
 - a. Type **Windows update** in the Windows search box and press Enter.
 - b. Click **Check for updates**. If an update package is available, it will be automatically downloaded and installed.
2. Remove unnecessary programs from the startup programs. Take the following steps:
 - a. Open the Start menu, and then click **Settings → Apps → Startup**.
 - b. In the **Startup** section, turn off the switch of programs that are not necessary to start automatically when you log in to Windows..
3. Enable Fast Startup. Take the following steps:
 - a. Type **choose a power plan** in the Windows search box and press Enter.
 - b. Select **Choose what the power buttons do** on the left sidebar.
 - c. Click **Change settings that are currently unavailable**.
 - d. Select **Turn on fast startup** under **Shutdown settings** tab, and then click **Save changes**.
4. Ensure that your computer automatically manages paging file size. Take the following steps:
 - a. Type **view advanced system settings** in the Windows search box and press Enter.
 - b. Click the **Advanced** tab and click **Settings** under **Performance**.
 - c. Click the **Advanced** tab and click **Change** under **Virtual memory**.
 - d. Ensure that **Automatically manage paging file size for all drives** is selected.
 - e. Click **OK** to save the changes. The changes will take effect after you restart your computer.
5. Free up more disk space. Take the following steps:
 - a. Open the Start menu, and then click **Settings → System → Storage**.
 - b. Select **Temporary files**, select the item you want to delete, and then click **Remove files**.

Note: The selected files and their data will be permanently deleted.

If the problem persists, do not hesitate to call Lenovo Customer Center. For the latest Lenovo Support phone numbers for your country or region, go to <https://pcsupport.lenovo.com/supportphonenumber>.

My computer does not shut down

Problem: What should I do if my computer does not shut down?

Solution If your computer does not shut down, try the following steps:

1. Shut down your computer by pressing the power button for 10 seconds until the screen turns off.
2. Check the power button on your computer and if it is a customer replaceable unit, replace it when necessary. For details, refer to the part replacement information in this *User Guide*.

If the problem persists, do not hesitate to call Lenovo Customer Center. For the latest Lenovo Support phone numbers for your country or region, go to <https://pcsupport.lenovo.com/supportphonenumber>.

My computer gets stuck in sleep or hibernate mode

Problem: What should I do if my computer gets stuck in sleep or hibernate mode?

Solution If your computer gets stuck in sleep or hibernate mode, try the following solutions one by one to troubleshoot and fix the issue:

1. Press any key on the keyboard, move the mouse, or quickly press the power button on your computer.
2. Use the embedded keyboard or pointing device, or an external non-Bluetooth device.
3. Restart your computer.
 - a. Shut down your computer by pressing the power button for 10 seconds until the screen turns off.
 - b. Wait about 1 minute. Then, press the power button to turn on your computer again.

To avoid future stuck in sleep or hibernate mode, you can complete the following settings:

1. Allow your desired keyboard to wake up your computer.
 - a. Type **Keyboard** in the Windows search box and then press Enter.
 - b. Under the **Hardware** tab, select the keyboard as desired.
 - c. Click **Properties** → **Change Settings**.
 - d. Under the **Power Management** tab, select **Allow this device to wake the computer**.
 - e. Follow the on-screen instructions to save your changes.
2. Edit power plan.
 - a. Type **cmd** in the Windows search box and Select **Run as administrator**.
 - b. Type **powercfg -h on** and then press Enter.
 - c. Type **Edit Power Plan** in the Windows search box and then press Enter.
 - d. Click **Change advanced power settings**.
 - e. Select **Sleep** → **Allow wake timers**.
 - f. Enable **On battery** and **Plugged in**.
 - g. Follow the on-screen instructions to save your changes.
3. Change power management settings.
 - a. Type **Device Manager** in the Windows search box and then press Enter.
 - b. Select **System devices**.
 - c. Double-click **Intel(R) Management Engine Interface #1**.
 - d. Clear **Allow the computer to turn off this device to save power** under the **Power management** tab.
 - e. Follow the on-screen instructions to save your changes.

If the problem persists, do not hesitate to call Lenovo Customer Center. For the latest Lenovo Support phone numbers for your country or region, go to <https://pcsupport.lenovo.com/supportphonenumber>.

The power button does not work

Problem: What should I do if the power button does not work?

Solution: If the power button does not work, try the following solutions one by one to troubleshoot and fix the issue:

1. If you want to start up the computer:
 - a. Check if the power indicator is on, to ensure that the power adapter is connected to your computer and the power cord of your computer is plugged into a working electrical outlet.
 - b. If you are using a power strip or surge protector, ensure it is turned on and working.
 - c. Press the power button to turn on your computer again.
2. If you want to shut down the computer:
 - a. Open the Start menu, click power icon , and then select **Shut down**.
 - b. Wait for the computer to shut down and then turn off the monitor and other peripheral devices.
3. For desktop or workstation computers, if the power button on your computer is a customer replaceable unit, replace it. For details, refer to the part replacement information in this *User Guide*.

If the problem persists, do not hesitate to call Lenovo Customer Center. For the latest Lenovo Support phone numbers for your country or region, go to <https://pcsupport.lenovo.com/supportphonenumber>.

Windows login error

Problem: What should I do if I cannot log in to Windows?

Solution: If you cannot log in to Windows, try the following solutions one by one to troubleshoot and fix the issue:

1. Restart your computer. The startup process might be interrupted abnormally. Restart to see if your computer can start up normally:
 - a. Shut down your computer by pressing the power button for 10 seconds until the screen turns off.
 - b. Wait about 1 minute. Then, press the power button to turn on your computer again.
2. Set the drive that the operating system has been installed on as the first boot device. Then, restart your computer. For details, refer to the BIOS related information in this *User Guide*.
3. Recover your Windows operating system. Depending on your specific situation, you can choose from different Windows recovery options. For details, go to https://support.microsoft.com/windows_recovery
4. Recover and restore the UEFI BIOS from the last uncorrupted and secure backup. Then, restart your computer. For details, refer to “UEFI BIOS problems” in this *User Guide*.
5. Reset the UEFI BIOS to factory default settings. Then, restart your computer. For details, refer to “BIOS problems” in this *User Guide*.

If the problem persists, do not hesitate to call Lenovo Customer Center. For the latest Lenovo Support phone numbers for your country or region, go to <https://pcsupport.lenovo.com/supportphonenumber>.

Blue screen during the startup

Problem: What should I do if I encounter a blue screen during the startup?

Solution: If you encounter a blue screen during the startup, try the following solutions one by one to troubleshoot and fix the issue:

1. Fix STOP code errors:

For details, go to https://support.microsoft.com/stop_code_error.

2. Update the Windows operating system. Take the following steps:
 - a. Restart your computer in safe mode. For details, go to https://support.microsoft.com/safe_mode.
 - b. Get the latest updates from the Windows Update. For details, go to https://support.microsoft.com/windows_update.
 - c. Restart your computer.

If the problem persists, do not hesitate to call Lenovo Customer Center. For the latest Lenovo Support phone numbers for your country or region, go to <https://pcsupport.lenovo.com/supportphonenumber>.

“no bootable device” error

Problem: What should I do if my computer displays a “no bootable device” error?

Solution If your computer displays a “no bootable device” error, try the following solutions one by one to troubleshoot and fix the issue:

1. Restart your computer to see if your computer can start up normally. Take the following steps:
 - a. Shut down your computer by pressing the power button for 10 seconds until the screen turns off.
 - b. Wait about 1 minute. Then, press the power button to turn on your computer again.
2. Set the drive that the operating system has been installed on as the first boot device. Then, restart your computer. For details, refer to the BIOS related information in this *User Guide*.
3. Create a bootable USB with UEFI Diagnostics. For details, go to <https://pcsupport.lenovo.com/createbootableusb>.
4. If the storage drive on your computer is a customer replaceable unit, replace it. For details, refer to the part replacement information in this *User Guide*.

If the problem persists, do not hesitate to call Lenovo Customer Center. For the latest Lenovo Support phone numbers for your country or region, go to <https://pcsupport.lenovo.com/supportphonenumber>.

Enable or disable secure boot

Problem: How to enable or disable secure boot?

Solution To enable or disable secure boot, take the following steps:

1. Restart the computer. When the logo screen is displayed, press F1 or Fn+F1.
2. Select **Security** → **Secure boot** and press Enter.
3. Slide the **Secure Boot** switch to enable or disable the function.

If you cannot enable or disable secure boot by the above mentioned method, try to change your computer settings. Refer to https://support.microsoft.com/secure_boot

If the problem persists, do not hesitate to call Lenovo Customer Center. For the latest Lenovo Support phone numbers for your country or region, go to <https://pcsupport.lenovo.com/supportphonenumber>.

My computer cannot boot from a USB drive

Problem: What should I do if my computer cannot boot from a USB drive?

Solution: If your computer cannot boot from a USB drive, try the following solutions one by one to troubleshoot and fix the issue:

1. Ensure that your USB drive is bootable. Go to File Explore to check the USB drive icon. Normally, the icon of a bootable drive on Windows 11 should have a blue monitor shape with a curved downward arrow.
2. Try another USB connector on your computer.
3. Ensure that your computer supports USB boot and change the boot priority order. Take the following steps:
 - a. Restart the computer. When the logo screen is displayed, choose one of the following solutions to enter the UEFI BIOS menu depending on your computer model:
 - For ThinkPad, ThinkBook, ThinkCentre and ThinkStation computers: Press F1.
 - For Yoga and IdeaPad computers: Press F2.
 - b. Enter the boot order section. Choose one of the following solutions depending on your computer model:
 - For ThinkPad computers: Select **Startup** → **Boot** to open the **Boot Priority Orders** submenu.
 - For ThinkBook, Yoga, and IdeaPad computers: Select **Boot**.
 - c. Ensure that the USB-related choice such as USB HDD or USB FDD is listed under the boot order list.
 - d. Select the USB drive you want to boot your computer from, and then press F10 to save the settings and exit.
4. Ensure that the your USB drive is formatted correctly.
 - If your computer uses Legacy BIOS mode, the USB drive should be formatted with NTFS file system.
 - If your computer uses UEFI boot mode, the USB drive should be formatted with FAT32.

If the problem persists, do not hesitate to call Lenovo Customer Center. For the latest Lenovo Support phone numbers for your country or region, go to <https://pcsupport.lenovo.com/supportphonenumberlist>.

Performance problems

My computer does not work

Problem: What should I do if my computer does not work?

Solution: If your computer does not work, try the following solutions one by one to troubleshoot and fix the issue:

1. Wait several seconds to see if your computer responds properly later.
2. Terminate tasks that are not responding.
3. Restart your computer.
 - Restart in Windows
 - a. Press Ctrl+Alt+Delete at the same time.
 - b. Click power icon , then select **Restart**.
 - Shut down and turn on the computer again
 - a. Shut down your computer by pressing the power button for 10 seconds until the screen turns off.
 - b. Wait about 1 minute. Then, press the power button to turn on your computer again.

If the problem persists, do not hesitate to call Lenovo Customer Center. For the latest Lenovo Support phone numbers for your country or region, go to <https://pcsupport.lenovo.com/supportphonenumberlist>.

My computer responds slowly

Problem: What should I do if my computer responds slowly?

Solution: If your computer responds slowly, try the following solutions one by one to troubleshoot and fix the issue:

1. Restart your computer.
2. Cool down your computer.
Turn off your computer, move it to a cooler place, and let it cool down for at least five minutes.
3. Clean up disks in Windows.
Delete temporary files and free up more drive space on your computer using Disk Cleanup. For details, go to https://support.microsoft.com/disk_cleanup.
4. Remove unnecessary programs from the startup programs.
 - a. Open the **Start** menu, and then click **Settings → Apps → Startup**.
 - b. In the **Startup** section, turn off the switch of programs that are not necessary to start automatically when you log in to Windows.
5. Uninstall unnecessary software.
6. Scan for viruses and Malware using the anti-virus software that is installed on your computer.
7. Change to another power mode with higher performance. For details, go to https://support.microsoft.com/change_the_power_mode_for_your_windows_pc.
8. Repair missing or corrupted system files using the System File Checker tool. For details, go to https://support.microsoft.com/system_file_checker.
9. Update the Windows operating system.
Get the latest updates from the Windows Update. For details, go to https://support.microsoft.com/windows_update.
10. Update drivers.
You can update drivers manually. For details, refer to “Driver problems” in this *User Guide*.
11. Recover your Windows operating system.
Depending on your specific situation, you can choose from different recovery options. For details, go to https://support.microsoft.com/windows_recovery.
12. Use memory module(s) with higher speed.

If the problem persists, do not hesitate to call Lenovo Customer Center. For the latest Lenovo Support phone numbers for your country or region, go to <https://pcsupport.lenovo.com/supportphonenumber>.

Beeping problems

Computer beeping

Problem: What should I do if my computer beeps?

Solution: If your computer beeps, try the following solutions one by one to troubleshoot and fix the issue:

1. Ensure that the computer is not overheating.
2. Power reset the computer. Take the following steps:
 - a. Shut down your computer.
 - b. Disconnect the computer from ac power and all peripheral devices.

- c. Press and hold the power button for 20 seconds to fully discharge.
3. Ensure that all internal hardware components such as memory and graphics card are properly connected.

If the problem persists, do not hesitate to call Lenovo Customer Center. For the latest Lenovo Support phone numbers for your country or region, go to <https://pcsupport.lenovo.com/supportphonenumber>.

Security problems

Improve my computer security

Problem: How to improve my computer security?

Solution: To improve your computer security, take the following steps:

1. Use strong passwords. A strong password is:
 - At least 12 characters long but 14 or more is better.
 - A combination of uppercase letters, lowercase letters, numbers, and symbols.
2. Keep software and system up-to-date. Take the following steps:
 - a. Open the Start menu, and then click **Settings → Windows Update**.
 - b. Click **Check for updates**. Windows will search for the latest updates and install them automatically.
3. Back up your data regularly. Choose one of the following locations to save your data:
 - The Cloud
 - A USB flash drive
 - An external hard drive
 - A CD or DVD disc
4. Protect your computer and data with Windows Security. Take the following steps:
 - a. Open the Start menu, click **Settings → Privacy & Security → Windows Security**.
 - b. Under **Protection areas**, select the item with yellow caution icon, and then follow the on-screen instructions to set up or turn on the unprotected category.
5. Ensure that the firewall on your system is turned on to block unauthorized access. Take the following steps:
 - a. Open the Start menu, and then click **Settings → Privacy & security → Windows Security → Firewall & network protection**.
 - b. Select a network profile: **Domain network**, **Private network** or **Public network**.
 - c. Turn on the switch under **Microsoft Defender Firewall**.

Note: If your device is connected to a network, network policy settings might prevent you from completing the step.

If the problem persists, do not hesitate to call Lenovo Customer Center. For the latest Lenovo Support phone numbers for your country or region, go to <https://pcsupport.lenovo.com/supportphonenumber>.

Password problems

Change my Windows password

Problem: How to change my Windows password?

Solution: To change your Windows password, take the following steps:

1. Type **Sign-in options** in the Windows search box and press Enter.
2. Select **Password** → **Change** and follow on-screen instructions to change the password.

If the problem persists, do not hesitate to call Lenovo Customer Center. For the latest Lenovo Support phone numbers for your country or region, go to <https://pcsupport.lenovo.com/supportphonenumberlist>.

Reset my Windows password

Problem: How to reset my Windows password?

Solution: To reset your Windows password, choose one of the following solutions:

- If you have set security questions, take the following steps:
 1. Click **Reset password** on the sign-in screen after you have entered an incorrect password.

Note: Contact your administrator if you do not see an option to reset your password.
 2. Follow on-screen instructions to reset a new password.
- If you have created a password reset disk, take the following steps:
 1. Connect a password reset disk to a USB-compatible connector on your computer.
 2. Follow on-screen instructions to reset your password.
- If you have an administrator account take the following steps:
 1. Sign in to your computer with the local administrator account.
 2. Follow on-screen instructions to reset your password.

If the problem persists, do not hesitate to call Lenovo Customer Center. For the latest Lenovo Support phone numbers for your country or region, go to <https://pcsupport.lenovo.com/supportphonenumberlist>.

Retrieve my BitLocker recovery key in Windows

Problem: How to retrieve my BitLocker recovery key in Windows?

Solution: To retrieve your BitLocker recovery key in Windows, choose one of the following solutions:

- In your Microsoft account:
 1. Open a web browser on any device such as mobile phone with internet access.
 2. Sign into your Microsoft account at <https://account.microsoft.com/devices/recoverykey>.
 3. Follow on-screen instructions to find the recovery key.
- On a printed paper:

Find out the paper with the record of BitLocker recovery information if you have printed or recorded the recovery key on the paper.
- On a USB flash drive:

1. Connect the USB flash drive into a USB-compatible connector on your computer.
 2. Follow the on-screen instructions to find the recovery key.
- By your administrator:
Contact your administrator to have the recovery key if your computer is connected to a domain or signed into an organization using a work or school e-mail account.

For more details, go to <https://support.microsoft.com/windows/finding-your-bitlocker-recovery-key-in-windows>.

If the problem persists, do not hesitate to call Lenovo Customer Center. For the latest Lenovo Support phone numbers for your country or region, go to <https://pcsupport.lenovo.com/supportphonenumber>.

OS problems

Install the Windows operating system

Problem: How to install the Windows operating system?

Solution: To install the Windows operating system, take the following steps:

Attention:

- It is recommended that you update your operating system through official channels. Any unofficial update might cause security risks.
 - The process of installing a new operating system deletes all the data on your internal storage drive, including the data stored in a hidden folder.
 - Before installing or upgrading a particular Windows version, make a backup copy of all the data that you want to keep.
 - Ensure that your computer is connected to the network and ac power during the whole process.
1. Get your computer ready for installing the Windows operating system. Take the following steps:
 - a. Microsoft® constantly makes updates to the Windows operating system. Before installing a particular Windows version, check the compatibility list and the minimum system requirements for the Windows version. For details, go to <https://support.lenovo.com/solutions/ht512575>.
 - b. For models with a Trusted Platform Module, if you are using the Windows BitLocker® Drive Encryption feature, ensure that you have disabled the feature. You can re-enable the feature after the operating system installation is complete.
 - c. Enable the security-related features (Security Chip, Virtualization, and Secure Boot). Take the following steps:
 - 1) Restart the computer. When the logo screen is displayed, choose one of the following solutions to enter the UEFI BIOS menu depending on your computer model:
 - For ThinkPad, ThinkBook, and Education series computers: Press F1.
 - For Yoga and IdeaPad computers: Press F2.
 - 2) Select **Security** and select the security-related features. Then, press Enter. Ensure that the security-related features are enabled.
 - 3) Press F10 to save the settings and exit.
 2. Connect the drive that contains the operating system installation program to the computer.
To create the installation media, refer to <https://support.microsoft.com/windows>.
 3. Restart the computer. When the logo screen is displayed, choose one of the following solutions to enter the UEFI BIOS menu depending on your computer model:

- For ThinkPad, ThinkBook, and Education series computers: Press F1.
 - For Yoga and IdeaPad computers: Press F2.
4. Choose one of the following solutions depending on your computer model:
 - For ThinkPad computers: Select **Startup → Boot** to open the **Boot Priority Order** submenu.
 - For Education series computers: Select **Startup → Boot Order → UEFI Boot Order**.
 - For ThinkBook, Yoga, and IdeaPad computers: Select **Boot**.
 5. Change the startup sequence. Take the following steps:
 - a. Select the drive that contains the operating system installation program. Choose one of the following solutions depending on your computer model:
 - For ThinkPad and Education series computers: Such as **USB HDD**. Then, press Esc.
 - For ThinkBook, Yoga, and IdeaPad computers: Such as **USB Boot**. Then, press Esc.
 - b. Press F10 to save the setting and exit.

Attention: After you change the startup sequence, ensure that you select the correct device during a copy, save, or format operation. If you select the wrong device, the data on that device might be erased or overwritten.

Note: If the system cannot boot from the selected drive, disable **Secure Boot** and try again. Ensure that you re-enable the feature after the operating system installation is complete.

6. Follow the on-screen instructions to install the device drivers and necessary programs.

If the problem persists, do not hesitate to call Lenovo Customer Center. For the latest Lenovo Support phone numbers for your country or region, go to <https://pcsupport.lenovo.com/supportphonenumber>.

Windows operating system installation error

Problem: What should I do if the installation of Windows operating system fails?

Solution: If the installation of Windows operating system fails, take the following steps:

1. Read the error message to figure out the specific cause.
2. Ensure that the UEFI BIOS version on your device is up-to-date.
3. Ensure that the available disk space of your computer meets the requirement of the new Windows operating system.
4. If you had antivirus software or a firewall installed on the previous system, temporarily disable the antivirus functionality within the BIOS before attempting system installation.
5. Reinstall the Windows system.

If the problem persists, do not hesitate to call Lenovo Customer Center. For the latest Lenovo Support phone numbers for your country or region, go to <https://pcsupport.lenovo.com/supportphonenumber>.

Upgrade my Windows operating system

Problem: How to upgrade my Windows operating system?

Solution: To upgrade your Windows operating system, take the following steps:

Attention:

- It is recommended that you upgrade your operating system through official channels. Any unofficial update might cause security risks.

- Before upgrading a particular Windows version, make a backup copy of all the data that you want to keep.
 - Ensure that your computer is connected to the network and ac power during the whole process.
1. Get your computer ready for updating the Windows operating system. Take the following steps:
 - a. Microsoft constantly makes updates to the Windows operating system. Before upgrading a particular Windows version, check the compatibility list and the minimum system requirements for the Windows version. For details, go to <https://support.lenovo.com/solutions/ht512575>.
 - b. For models with a Trusted Platform Module, if you are using the Windows BitLocker® Drive Encryption feature, ensure that you have disabled the feature. You can re-enable the feature after the operating system installation is complete.
 - c. Enable the security-related features (Security Chip, Virtualization, and Secure Boot). Take the following steps:
 - 1) Restart the computer. When the logo screen is displayed, choose one of the following ways to enter the UEFI BIOS menu depending on your computer model:
 - For ThinkPad, ThinkBook and Education series computers: Press F1.
 - For Yoga and IdeaPad computers: Press F2.
 - 2) Select **Security** and select the security-related features. Then, press Enter. Ensure that the security-related features are enabled.
 - 3) Press F10 to save the settings and exit.
 2. Type **Windows Update** in the Windows search box and press Enter.
 3. Click **Check for updates**. If an operating system update package is available, it will be automatically downloaded and installed.
 4. Follow the on-screen instructions to install the device drivers and necessary programs.

If the problem persists, do not hesitate to call Lenovo Customer Center. For the latest Lenovo Support phone numbers for your country or region, go to <https://pcsupport.lenovo.com/supportphonenumber>.

Windows operating system upgrading error

Problem: What should I do if the upgrading of Windows operating system fails?

Solution: If the upgrading of Windows operating system fails, take the following steps:

1. Read the error message to figure out the specific cause.
2. Ensure that the UEFI BIOS version on your device is up-to-date.
3. Ensure that the available disk space of your computer meets the requirement of the new Windows operating system.
4. Upgrade the system again.

If the problem persists, do not hesitate to call Lenovo Customer Center. For the latest Lenovo Support phone numbers for your country or region, go to <https://pcsupport.lenovo.com/supportphonenumber>.

Recover Windows operating system

Problem: How to recover my Windows operating system?

Solution: To recover your Windows operating system, choose one of the following recovery options:

- **Reset system to factory default:**
 - Reset your computer from Settings. Take the following steps:
 1. Open the Start menu, and then click **Settings** → **System** → **Recovery**.

2. Select **Reset PC** under **Recovery options**.
 3. Select **Keep my files** or **Remove everything** as desired to reset the system.
- Reset your computer from Windows Recovery Environment. Take the following steps:
 1. Restart your computer. When the logo screen is displayed, press F11 to enter the Windows Recovery Environment.
 2. Click **Troubleshoot** → **Reset this PC** → **System Restore**.
 3. Select **Keep my files** or **Remove everything** as desired to reset the system.
 - Refer to the instructions in <https://support.lenovo.com/HowToCreateLenovoRecovery>.
- **Other recovery options such as recovering system to a previous system point:**
Refer to the instructions in Popular Topics: <https://support.lenovo.com/solutions/ht118590>.

Here are some frequently-asked cases and solutions for your reference:

Cases	Solutions
Your computer does not work well and you recently installed a device from Windows Update.	Remove the installed update device.
Your computer does not work well and it has been a while since you installed an app or changed system settings.	Reset your system.
Your computer cannot start or is still loading.	Use the Startup Repair function.
Your computer cannot start, you have not created a recovery drive, and resetting your computer does not work.	Use installation media to reinstall Windows operating system.
Your computer cannot start and you have not created a recovery drive.	Use installation media to restore your computer.
Your computer cannot start and you have created a recovery drive.	Use a recovery drive to restore or recover your computer.
You want to reinstall your previous operating system.	Go back to your previous version of Windows operating system.
Your computer does not work well and you recently installed an app.	Restore from a system restore point.
You suspect your device has been infected.	Use installation media to reinstall Windows operating system.

If the problem persists, do not hesitate to call Lenovo Customer Center. For the latest Lenovo Support phone numbers for your country or region, go to <https://pcsupport.lenovo.com/supportphonenumber>.

Windows operating system recovery error

Problem: What should I do if the recovery of Windows operating system fails?

Solution: If the recovery of Windows operating system fails, take the following steps:

1. Read the error message to figure out the specific cause.
2. Ensure that the computer is connected to the network and ac power source.
3. Ensure that the UEFI BIOS version on your device is up-to-date.
4. Ensure that the available disk space of your computer meets the requirement of the new Windows operating system.
5. Reinstall the Windows operating system.

If the problem persists, do not hesitate to call Lenovo Customer Center. For the latest Lenovo Support phone numbers for your country or region, go to <https://pcsupport.lenovo.com/supportphonenumber>.

Driver problems

Update or install the latest device driver

Problem: How to update or install the latest device driver?

Solution: Download the latest driver for a component when you notice poor performance from that component or when you install a new component.

Attention:

- Before updating or installing a driver:
 - Check if it is compatible with your computer. Ensure that the driver you download matches your computer and system version to avoid compatibility issues.
 - Make a backup copy of all the essential data to avoid data loss, especially for drivers like graphic card, sound card, network card, and so on. These drivers might affect the stability and the performance of your computer.
- During the process of updating or installing a driver, ensure that your computer is connected to the network.
- After completing the process of updating or installing a driver, restart your computer to enable the new driver.
- Among the following solutions, it is recommended to download Lenovo-qualified drivers from Lenovo Support Web site.

To update and install the latest driver, try one of the following solutions:

- From the Lenovo Support Web site:
 1. Go to <https://pcsupport.lenovo.com> and type the product name or the serial number of your computer into the search box and select your product from the dropdown list.
 2. Click **Drivers & Software**. Click **Select Drivers** under the **Manual Update** tab. Select and download the update package as desired.
 3. Follow the instruction at <https://support.lenovo.com/solutions/HT074189> to manually install the driver.
- From the Windows Update:
 1. Type **Windows Update** in the Windows search box and press Enter.
 2. Click **Check for Updates**. If an update package is available, it will be automatically downloaded and installed.
- From the Vantage app:

Note: Ensure that the Vantage app is up to date for the best features and performance.

1. Open the Vantage app and then click **Device** → **System Update** → **CHECK FOR UPDATES**.
2. If an update package is available, follow the on-screen instructions to download and install the package.

If the problem persists, do not hesitate to call Lenovo Customer Center. For the latest Lenovo Support phone numbers for your country or region, go to <https://pcsupport.lenovo.com/supportphonenumber>.

Driver installation error

Problem: What should I do if I encounter driver installation errors?

Solution: If you encounter driver installation errors, try the following solutions to troubleshoot and fix the issue according to your case:

Cases	Solutions
The device cannot be recognized by the system.	<p>Try the following solutions one by one:</p> <ol style="list-style-type: none"> 1. Ensure that the driver you just installed matches your computer and system version in Lenovo Support Web site. 2. Restart your computer. 3. Reinstall the driver. Take the following steps: <ol style="list-style-type: none"> a. Type device manager in the Windows search box. b. Click Device Manager from the list of results. The Device Manager window opens. c. Right-click the device that cannot be recognized. Then, select Uninstall device. d. After the driver is uninstalled, restart your computer. Windows will automatically install the latest driver.
An error message is displayed.	<p>Take the following steps:</p> <ol style="list-style-type: none"> 1. Read the error message to figure out the specific cause. 2. Download the appropriate driver version from Lenovo support Web site according to the error message. 3. Reinstall the driver.
There is an exception in Device Manager.	<p>Try the following solutions one by one:</p> <ol style="list-style-type: none"> 1. Reinstall the driver. 2. Roll back to the previously installed driver.
<p>There are some system stability issues, for example:</p> <ul style="list-style-type: none"> • The system frequently crashes. • Blue Screen of Death occurs. 	<p>For detailed operations, refer to the “Display problems” in this <i>User Guide</i>.</p>
Performance degradation	<p>For detailed operations, refer to the “Performance problems” in this <i>User Guide</i>.</p>
The installation progress is stuck.	<p>Try the following solutions one by one:</p> <ol style="list-style-type: none"> 1. Restart your computer. 2. Reinstall the driver.

Find general solutions, go to <https://support.lenovo.com/solutions/HT105331>

If the problem persists, do not hesitate to call Lenovo Customer Center. For the latest Lenovo Support phone numbers for your country or region, go to <https://pcsupport.lenovo.com/supportphonenumber>.

UEFI BIOS problems

Update the UEFI BIOS

Problem: How to update the UEFI BIOS?

Solution: To update the UEFI BIOS, choose one of the following solutions:

Note: During the UEFI BIOS update process, MRC change might cause memory retraining. Memory retraining is a process to initialize the memory module and run diagnostic tests for the memory module in your computer. When memory retraining occurs, the screen might be blank. For some computer models, you might see the LED indicators on Esc, F1, and F4 blinking sequentially to indicate the progress. **Do not press the power button to interrupt the process.** Wait a few minutes until the logo screen is displayed.

- From the Lenovo Support Web site:
 1. Go to <https://pcsupport.lenovo.com> and search by your product name.
 2. Click **Drivers & Software** → **Select Drivers** under **Manual Update** tab **BIOS/UEFI**.
 3. Follow the on-screen instructions to download and install the latest UEFI BIOS update package.
- From the Windows Update:
 1. Type **Windows update** in the Windows search box and press Enter.
 2. Click **Check for updates**.
 3. If a UEFI BIOS update package is available, it will be automatically downloaded and installed.
- From the Vantage app (for some computer models):
 1. Open the Vantage app, and then click **Device** → **System Update** → **CHECK FOR UPDATES**.
 2. If the latest UEFI BIOS update package is available, follow the on-screen instructions to download and install the package.

If the problem persists, do not hesitate to call Lenovo Customer Center. For the latest Lenovo Support phone numbers for your country or region, go to <https://pcsupport.lenovo.com/supportphonenumberlist>.

UEFI BIOS update error

Problem: What should I do if the update of UEFI BIOS update fails?

Solution: If the update of UEFI BIOS update fails, take the following steps:

1. Check if any error messages to figure out the specific cause.
2. Ensure that the downloaded package is from Lenovo Support website.
3. Ensure that your computer is connected to a working power outlet.
4. Update the UEFI BIOS again.

If the problem persists, do not hesitate to call Lenovo Customer Center. For the latest Lenovo Support phone numbers for your country or region, go to <https://pcsupport.lenovo.com/supportphonenumberlist>.

Recover the UEFI BIOS

Problem: How to recover the UEFI BIOS?

Solution: If the UEFI BIOS is corrupted or maliciously attacked, the UEFI BIOS will automatically recover from the last uncorrupted and secure backup to protect your computer data.

During the UEFI BIOS auto-recovery, the screen will go blank. Do not press the power button to interrupt the progress. Wait a few minutes until the logo screen is displayed.

Note: For some computer models, you can check the progress based on blinking modes of the LED indicators on Esc, F1, and F4. For details, refer to the following table.

Blinking modes	Self-recovery progress
LED indicator on Esc blinks	0% to 32%
LED indicators on Esc and F1 blink simultaneously	33% to 65%
LED indicators on Esc, F1 and F4 blink simultaneously	66% to 100%

If the problem persists, do not hesitate to call Lenovo Customer Center. For the latest Lenovo Support phone numbers for your country or region, go to <https://pcsupport.lenovo.com/supportphonenumber>.

Reset system to factory defaults

Problem: How to reset system to factory defaults?

Solution: For some computer models, you can reset the UEFI BIOS to the factory default settings, including all UEFI BIOS settings and internal system data. It helps you wipe user data in case that you want to dispose of or reuse your computer.

User data erasure is performed on the following components (if available):

- UEFI BIOS
- Security Engine
- Embedded Controller
- Fingerprint Reader
- TPM

To reset system to factory defaults, take the following steps:

1. Restart the computer. When the logo screen is displayed, press F1 to enter the UEFI BIOS menu.
2. Select **Security** → **Reset System to Factory Defaults** and press Enter.
3. Several warning windows might be displayed. Follow the instructions to prepare for the reset.
4. Select **Reset System to Factory Defaults** again and select **Yes** to reset.

If the problem persists, do not hesitate to call Lenovo Customer Center. For the latest Lenovo Support phone numbers for your country or region, go to <https://pcsupport.lenovo.com/supportphonenumber>.

Storage device problems

My solid-state drive is not detected

Problem : What should I do if my computer does not detect the solid-state drive?

Solution: If your computer cannot detect the solid-state drive, try the following solutions one by one to troubleshoot and fix the issues:

1. Restart your computer.

2. The drive letter of the solid-state drive might be missing or in conflict with that of another disk. In this case, you can assign a new drive letter to the solid-state drive:
 - a. Right-click the Windows icon  and click **Disk management**.
 - b. Right-click the solid-state drive and click **Change Drive Letter and Paths...**
 - c. Click **Change**. Select a new drive letter from the list and then click **OK** to save your configuration.
3. Enable the disk drive:
 - a. Type **device manager** in the Windows search box and then press Enter.
 - b. Click the arrow icon > next to **Disk Drives** to expand the section.
 - c. Right-click the disk drive and click **Enable device**.

Note: If the **Enable device** option is not displayed, that means the disk drive is enabled already.
4. Reinstall the disk drive:
 - a. Type **device manager** in the Windows search box and then press Enter.
 - b. Click the arrow icon > next to **Disk Drives** to expand the section.
 - c. Right-click the disk drive and click **Uninstall device**.
 - d. Restart the computer. The driver will be automatically installed after the computer restarts. Verify if your computer can detect the storage device now.
5. Update the UEFI BIOS to the latest version, For details, refer to “UEFI BIOS problems” in this *User Guide*.
6. Update the solid-state drive firmware:
 - a. Open the Vantage app and then click **Device → System Update → CHECK FOR UPDATES**.
 - b. If the solid-state drive firmware update package is available, follow the on-screen instructions to download and install the package.

If the problem persists, do not hesitate to call Lenovo Customer Center. For the latest Lenovo Support phone numbers for your country or region, go to <https://pcsupport.lenovo.com/supportphonenumber>.

External storage device is not recognized

Problem : What should I do if my computer does not recognize the external storage device?

Solution: If your computer does not recognize your external storage device, try the following solutions one by one to troubleshoot and fix the problem:

1. Ensure that the external storage device is connected correctly to a working and compatible connector on your computer.
2. Uninstall and then reconnect the external storage device:
 - a. Type **device manager** in the Windows search box and then press Enter.
 - b. Click the arrow icon > next to **Disk Drives** to expand the section.
 - c. Right-click the external storage device and click **Uninstall device**.
 - d. Disconnect the external storage device.
 - e. Wait for one minute and then reconnect the external storage device.
3. Click **Start → Settings → Windows Update → Check for updates** to install the latest Windows updates.

If the problem persists, do not hesitate to call Lenovo Customer Center. For the latest Lenovo Support phone numbers for your country or region, go to <https://pcsupport.lenovo.com/supportphonenumber>.

Storage device read/write error

Problem : What should I do if I encounter storage device read/write error? For example, I cannot open a file.

Solution: To troubleshoot and fix the storage device read/write error, try the following solutions one by one:

1. Update the storage device driver:
 - a. Type **device manager** in the Windows search box and then press Enter.
 - b. Click the arrow icon > next to **Disk Drives** to expand the section.
 - c. Right-click the disk drive, click **Update driver** and follow the on-screen instructions.
2. Run the disk error checking:
 - a. Go to **This PC**.
 - b. Right-click the disk drive that you want to check and click **Properties → Tools**.
 - c. Click **Check** in the error checking section and follow the on-screen instructions.
3. Update the solid-state drive firmware:
 - a. Open the Vantage app and then click **Device → System Update → CHECK FOR UPDATES**.
 - b. If the solid-state drive firmware update package is available, follow the on-screen instructions to download and install the package.

If the problem persists, do not hesitate to call Lenovo Customer Center. For the latest Lenovo Support phone numbers for your country or region, go to <https://pcsupport.lenovo.com/supportphonenumber>.

Recovery problems

Recover deleted files on my computer

Problem: How to recover deleted files on my computer?

Solution: To recover deleted files on your computer, try the following solutions one by one:

1. Check the Recycle Bin. Take the following steps:
 - a. Go to the **Recycle Bin** on your desktop and look for the deleted files.
 - b. If the deleted files are in the **Recycle Bin**, right-click the files and select **Restore** to recover them to their original location.
2. Use **File History**. If you have **File History** enabled, you can recover files from a previous version. Take the following steps:
 - a. Go to the folder where the files were originally stored.
 - b. Right-click the folder and select **Properties**.
 - c. Select **Previous Versions** tab, choose the version you need, and click **Restore**.
3. If you use **OneDrive** for syncing files, go to the OneDrive website, log in, and check the **Recycle Bin** there.
4. If your essential system files are missing, take the following steps :
 - a. Go to **Settings → System → Recovery**.
 - b. Select one of the following options as you prefer:
 - **Fix problems without resetting your PC**
 - **Fix problems using Windows Update**
 - **Reset this PC**

If the problem persists, do not hesitate to call Lenovo Customer Center. For the latest Lenovo Support phone numbers for your country or region, go to <https://pcsupport.lenovo.com/supportphonenumberlist>.

Recover my computer

Problem: How to recover my computer?

Solution: To recover your computer, try the following solutions one by one::

1. Restore your computer to factory settings. Take the following steps:
 - a. Go to **Settings → System → Recovery → Reset this PC**.
 - b. Select **Keep my files** or **Remove everything** as you prefer.
 - c. Follow the on-screen instructions to complete the reset.
2. Restore your computer to an earlier working state. Go to <https://support.microsoft.com/windows/recovery-options-in-windows> and follow the instructions.
3. If your computer does not start properly, to restore the computer, take the following steps:
 - a. Restart the computer and press F8 to enter **Advanced Startup Options**.
 - b. Go to **Troubleshoot → Reset this PC**.
 - c. Select **Keep my files** or **Remove everything** as you prefer.
 - d. Follow the on-screen instructions to complete the reset.

If the problem persists, do not hesitate to call Lenovo Customer Center. For the latest Lenovo Support phone numbers for your country or region, go to <https://pcsupport.lenovo.com/supportphonenumberlist>.

Self-help resource

Find more information about your device through the following self-help resources.

Product information

- Product specifications: <https://psref.lenovo.com>
- Technical specifications for Lenovo workstations: <https://thinkstation-specs.com>

Lenovo Support resource

- Lenovo PC Technical Support web site: <https://pcsupport.lenovo.com>. You can obtain the following information and resources:
 - Drivers and software
 - Troubleshoot and diagnose
 - How to's
 - Guides and manuals
 - Warranty lookup
 - Parts lookup
 - Accessories
 - Contact us
 - Repair status check
 - Imaging and security resources
 - Glossary
- Lenovo Support phone numbers: <https://pcsupport.lenovo.com/supportphonenumberlist>

- Vantage app: Type **vantage** in the Windows search box. You can use the app to:
 - Configure device settings
 - Download and install UEFI BIOS, drivers, and firmware updates
 - Secure your device from outside threats
 - Diagnose hardware problems
 - Check the warranty status of your device
 - Access *User Guide* and helpful articles
- Lenovo communities:
 - Forums: <https://forums.lenovo.com>
 - Legion Gaming Community: <https://gaming.lenovo.com>
 - Lenovo EDU Community: <https://education.lenovo.com>
 - Lenovo Pro Community: <https://smbcommunity.lenovo.com>
- Troubleshooting tips: <https://www.lenovo.com/tips>

Service information

- Warranty lookup: <https://support.lenovo.com/warranty-lookup>. You can check the warranty status of your device.
- Repair status check: <https://support.lenovo.com/track-repair-status>. You can check the repair status of your device by repair ticket, serial number, or IMEI number.
- Parts lookup and purchase: <https://support.lenovo.com/parts-lookup>. You can find service parts by serial number or machine type.
- Lenovo BIOS Simulation Center: <https://download.lenovo.com/bsco/index.html>. You can explore the BIOS settings of your device.
- Additional services purchase: <https://pcsupport.lenovo.com/warrantyupgrade>. You can protect your device with extended warranty, Accidental Damage Protection, Premium Care & Support, and Vantage Smart Performance.

Product documentation

Documentation title	Information included	How to Access
<i>Setup Guide</i>	Initial setup and overview information	<ul style="list-style-type: none"> • Access the printed version from the product package. • Go to https://pcsupport.lenovo.com and search by the product name or serial number. Then, click Guides & Manuals.
<i>User Guide</i>	Instructions, guidance, resources, and contact information	<ul style="list-style-type: none"> • Scan the QR code in <i>Setup Guide</i>. • In Windows Start menu, click User Guide . • Type vantage in the Windows search box and press Enter. Then, find the <i>User Guide</i> in the app. • Go to https://pcsupport.lenovo.com and search by the product name or serial number. Then, click Guides & Manuals.
<i>Hardware Maintenance Manual</i>	Hardware diagnostic and replacement information for technicians	Go to https://pcsupport.lenovo.com and Search by the product name or serial number. Then, click Guides & Manuals .

Operating system support resource

- Windows help information
 - Type **get help** in the Windows search box
 - Use Windows Search
 - Microsoft Support Web site: <https://support.microsoft.com>
- Reset or restore Windows
 - Use Lenovo recovery options: <https://support.lenovo.com/HowToCreateLenovoRecovery>
 - Use Windows recovery options: Go to <https://pcsupport.lenovo.com> and search by the product name or serial number. Then, navigate to the troubleshooting menu to diagnose the operating system for recovery instructions.

Accessory information

- Purchase accessories: <https://www.lenovo.com/accessories>
- Service recommendation and accessory configurator: <https://smartfind.lenovo.com>
- Accessories and option compatibility matrix: <https://www.lenovo.com/accessoriesguide>

Legal and compliance information

- Product compliance: <https://www.lenovo.com/compliance>
- Legal information: <https://www.lenovo.com/us/en/legal>
- Regulatory documentation: Go to <https://pcsupport.lenovo.com> and search by the product name or serial number. Then, click **Guides & Manuals**.
 - *Safety and Warranty Guide*: Safety, warranty, recycling, and other information
 - *Generic Safety and Compliance Notices*: Compliance, accessibility, RoHS, and other information
 - *Regulatory Notice*: Regulatory notices for wireless modules

Lenovo responsibility

- Accessibility information: <https://www.lenovo.com/accessibility>
- Environment information: <https://www.lenovo.com/us/en/sustainability-operational-impact>
- Product security: <https://www.lenovo.com/us/en/product-security/landing/>

Chapter 7. Help and support

This chapter provides solutions to some hardware and software issues.

Error messages

An error message is displayed for each error detected in POST or system operation. Refer to the error messages in the table below to solve your computer problems.

If you see a message that is not included in the following table, record the error message first, then shut down the computer and call Lenovo for help. See “Lenovo Customer Support Center” on page 94.

Message	Solution
0190: Critical low-battery error	The computer turned off because the battery power is low. Connect the ac power adapter to the computer and charge the batteries.
0191: System Security - Invalid remote change requested	The system configuration change has failed. Confirm the operation and try again.
0199: System Security - Security password retry count exceeded.	This message is displayed when you enter a wrong supervisor password more than three times. Confirm the supervisor password and try again.
0271: Check Date and Time settings.	The date or the time is not set in the computer. Enter the UEFI BIOS menu and set the date and time.
210x/211x: Detection/Read error on HDDx/SSDx	The storage drive is not working. Reinstall the storage drive. If the problem still exists, replace the storage drive.

Note:

This error indicates that the operating system or programs cannot create, modify, or delete data in the non-volatile system UEFI variable storage due to insufficient storage space after POST.

The non-volatile system UEFI variable storage is used by the UEFI BIOS and by the operating system or programs. This error occurs when the operating system or programs store large amounts of data in the variable storage. All data needed for POST, such as UEFI BIOS setup settings, chipset, or platform configuration data, are stored in a separate UEFI variable storage.

Press F1 after the error message is displayed to enter the UEFI BIOS menu. A dialog asks for confirmation to clean up the storage. If you select “Yes”, all data that were created by the operating system or programs will be deleted except global variables defined by the Unified Extensible Firmware Interface Specification. If you select “No”, all data will be kept, but the operating system or programs will not be able to create, modify, or delete data in the storage.

If this error happens at a service center, Lenovo-authorized service personnel will clean up the non-volatile system UEFI variable storage using the preceding solution.

Error: The non-volatile system UEFI variable storage is nearly full.

Battery-charge LED indicator diagnosis

The battery-charge LED indicator (hereafter referred to as LED indicator) blinks to help you diagnose and solve some computer problems.



Indicator blinking patterns





The LED indicator blinks amber first and then white continually, consisting of different blinking patterns. Each blinking pattern corresponds to an error code. For example, when the LED indicator blinks amber once ● and then blinks white twice ○○, the blinking pattern ●○○ corresponds to error code 0001.

Notes:

- The LED indicator blinks automatically only when the error in the following table occurs.
- The LED indicator blinks continually until the computer turns off. If you need to interrupt the process, press power button for a few seconds.
- We recommend that you speak to our Customer Support Center before attempting to service the computer yourself so that you can be directed to the correct documentation and repair information. It might be recommended to have a Lenovo-authorized service provider repair your computer depending on the complexity of the error or fault.

Refer to the blinking patterns and error codes in the table below to solve your computer problems.

Blinking patterns	Error codes	Solutions
●○○○	0001: Reset error (platform reset not de-asserted)	<ol style="list-style-type: none"> 1. Remove the ac power adapter and the removable battery if your computer has one. Then, reset the computer by doing one of the following: <ul style="list-style-type: none"> • For models with the emergency-reset hole, insert a straightened paper clip into the emergency reset hole to cut off power supply temporarily. Then, restart the computer with ac power connected. • For models without the emergency-reset hole, press and hold the power button for about seven seconds. Then, reconnect to all power resources and restart the computer. 2. If step 1 does not work, replace the system board (service provider only).
●○○○○	0002: Internal bus error	Replace the system board (service provider only).
●●○○○	0283: PCI resource error	<ol style="list-style-type: none"> 1. Remove PCIe devices (the M.2 card, PCIe card, and so on) (service provider only). 2. If step 1 does not work, replace the system board (service provider only).

Blinking patterns	Error codes	Solutions
	0284: TCG-compliant functionality-related error (might be the BIOS code validation failure)	Replace the system board (service provider only).
	0285: TCG-compliant functionality-related error (might be the TPM initialization failure)	Replace the system board (service provider only).
	0286: Integrated graphics error	Replace the system board (service provider only).
	0288: Computer display error	<ol style="list-style-type: none"> 1. Reconnect the display cable on both the system board side and the computer display side (service provider only) and check the LCD panel. 2. If step 1 does not work, connect an external display to your computer and check the status (customer or service provider). <ul style="list-style-type: none"> • If the external display works, replace the LCD panel (service provider only). • If the external display does not work, replace the system board (service provider only).

Diagnostics tool

This section provides introduction to a set of diagnostics and troubleshooting tools at Lenovo Support Web site, the Vantage app, and in your computer. They can help you diagnose common software and hardware issues.

The following table lists these diagnostics tools and the recommended conditions for each tool.

Diagnostics tool	Recommended scenario
Troubleshoot and diagnose at Lenovo Support Web site	You want to have an online troubleshooting or scan of hardware and drivers on your computer.
Hardware scan	<ul style="list-style-type: none"> • Your computer is installed with the Vantage app. • You want to perform basic examinations of the hardware components.
UEFI Diagnostics tool	<ul style="list-style-type: none"> • You cannot log in to the operating system. • Your computer cannot connect to the network.

Troubleshoot and diagnose at Lenovo Support Web site

Lenovo provides two different diagnosing options to help you identify and resolve problems on your computer.

- Step 1. Go to <https://www.pcsupport.lenovo.com/> and enter your product name in the search box.
- Step 2. Click **Troubleshoot & Diagnose** and select from the following two options depending on your needs.

If you are unsure of the problem with your computer, it is recommended that you select **Easy** and follow on-screen instructions to get your firmware updated and obtain the hardware status.

If you have identified the problem on your computer, you can select **Custom** and follow on-screen instructions to resolve the problem.

Notes:

- Before launching any automatic diagnosing process, a pop-up window will prompt you to install Lenovo Service Bridge. Lenovo Service Bridge helps to connect your computer with Lenovo diagnosing tools.
- Lenovo Support Web site makes periodic updates of the sections to keep improving your experience with your computer. The Web site interface and descriptions of sections might be different from that on your actual interface.

If solutions cannot resolve problems on your computer, you can follow on-screen instructions to submit an e-ticket or contact Lenovo for professional assistance.

Hardware scan

Hardware scan is an effective hardware testing tool to help you identify existing hardware issues.

To run the Hardware scan:

- Step 1. Type **Vantage** in the Windows search box and then press Enter.
- Step 2. Click **Hardware scan** or **Support → Hardware scan**.
- Step 3. Select **QUICK SCAN** or **CUSTOMIZE** and then follow the on-screen instructions to run the hardware scan.

Notes:

- The Quick Scan tool contains a pre-selected suite of tests that performs basic examinations of the hardware components found in the system. The Customize tool enables you to select one or several hardware components to perform the examinations.
- Before selecting **QUICK SCAN**, click **Refresh Modules** to ensure that the list of hardware components is the components currently available for the computer.

- Step 4. If any hardware failure is detected, the result varies depending on the warranty status and varies by country or region. Follow the on-screen instructions to resolve the issue.

UEFI Diagnostics tool

UEFI Diagnostics tool enables you to view system information and identify hardware issues when you cannot log in to the operating system, or the computer cannot connect to the network.

To use the UEFI Diagnostics tool:

- Step 1. Connect your computer to ac power.
- Step 2. Turn on your computer, and press F10 immediately to enter the UEFI Diagnostics tool.
- Step 3. Follow the on-screen instructions to run the test.
- Step 4. Press Esc to exit the tool. Your computer will restart immediately.
- Step 5. If any hardware failure is detected and you are unable to locate and resolve the problem, you can call Lenovo Customer Support Center. See “Call Lenovo” on page 93.

Lenovo Memory Self Repair (for Intel models only)

Lenovo Memory Self Repair (hereafter referred to as repair tool) enables you to repair memory single-bit or single-row failure with internal redundant resources.

It is recommended that you use the repair tool in the following situations:

- The operating system is unstable, such as having blue screen error or system crash.
- Any application operates abnormally, such as crashing or quitting unexpectedly.
- Any test result indicates memory-related errors.

Note: The repair tool can be used only when your computer can be turned on normally.

Step 1. Restart the computer.

Step 2. When the logo screen is displayed, trigger the repair tool by one of the following methods:

- Press F4.
- Press Enter to enter **Startup Interrupt Menu**, and then press F4.
- Press F12 to enter **App Menu**, and then select **Lenovo Memory Self Repair**.

Step 3. Read through the important information in the displayed window and click **Yes** to run the tool.

Step 4. Check the repair result on the pop-up dialog box. There are three types of results.

- **Memory Repaired:** it means that the memory failure is detected and repaired.
- **Memory failure detected but repair was unsuccessful:** it means that the memory failure is detected but cannot be repaired.
- **No failure detected:** it means that no memory failure is detected.

If the issue persists, you can try again or contact Lenovo for additional support.

Step 5. Click **Continue** to turn on the computer.

Related topics

“Call Lenovo” on page 93

Windows label

Windows Genuine Microsoft label indicates the edition of Windows preinstalled on your computer and whether the device is preinstalled with or licensed for genuine Windows.

Your computer might have a Windows Genuine Microsoft label affixed to its cover depending on the following factors:

- Your geographic location
- Edition of Windows that is preinstalled

Go to <https://www.microsoft.com/howtotell/Hardware.aspx> for illustrations of the various types of Genuine Microsoft labels.

- In the People’s Republic of China, the Genuine Microsoft label is required on all computer models preinstalled with any edition of the Windows operating system.
- In other countries and regions, the Genuine Microsoft label is required only on computer models licensed for Windows Pro editions.

The absence of a Genuine Microsoft label does not indicate that the preinstalled Windows version is not genuine. For details on how to tell whether your preinstalled Windows product is genuine, refer to the information provided by Microsoft at <https://www.microsoft.com/howtotell/default.aspx>.

There are no external, visual indicators of the Product ID or Windows version for which the computer is licensed. Instead, the Product ID is recorded in the computer firmware. Whenever a Windows product is installed, the installation program checks the computer firmware for a valid, matching Product ID to complete the activation.

In some cases, an earlier Windows version might be preinstalled under the terms of the Windows Pro edition license downgrade rights.

Call Lenovo

If you have tried to correct the problem yourself and still need help, you can call Lenovo Customer Support Center.

Before you contact Lenovo

Prepare the needed information before you contact Lenovo.

1. Record the problem symptoms and details:
 - What is the problem? Is it continuous or intermittent?
 - Any error message or error code?
 - What operating system are you using? Which version?
 - Which software applications were running at the time of the problem?
 - Can the problem be reproduced? If so, how?
2. Record the system information:
 - Product name.
 - Machine type and “serial number” on page 93.

Find your service QR code and serial number

This topic helps you find service QR code and serial number.

Scan the QR code on the base cover assembly to view the following information:

- Your product information and warranty status
- The latest Lenovo-verified drivers and software
- Troubleshooting and diagnosing solutions when hardware or software issue is encountered
- Customer support center and e-ticket entry for professional support

You can find your serial number via:

- **Dashboard** or **Device** in the **Vantage** app
- Serial-number label of your computer (shown as below illustration)

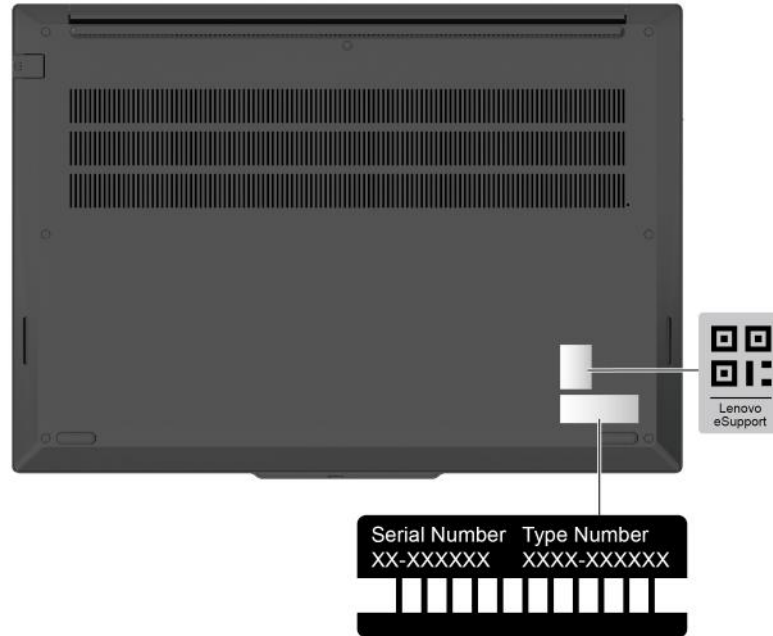

Lenovo Customer Support Center

During the warranty period, you can call Lenovo Customer Support Center for help.

Telephone numbers

For a list of the Lenovo Support phone numbers for your country or region, go to <https://pcsupport.lenovo.com/supportphonenumber> for the latest phone numbers.

Note: Phone numbers are subject to change without notice. If the number for your country or region is not provided, contact your Lenovo reseller or Lenovo marketing representative.

Services available during the warranty period

- Problem determination - Trained personnel are available to assist you with determining if you have a hardware problem and deciding what action is necessary to fix the problem.
- Lenovo hardware repair - If the problem is determined to be caused by Lenovo hardware under warranty, trained service personnel are available to provide the applicable level of service.
- Engineering change management - Occasionally, there might be changes that are required after a product has been sold. Lenovo or your reseller, if authorized by Lenovo, will make selected Engineering Changes (ECs) that apply to your hardware available.

Services not covered

- Replacement or use of parts not manufactured for or by Lenovo or nonwarranted parts
- Identification of software problem sources
- Configuration of UEFI BIOS as part of an installation or upgrade
- Changes, modifications, or upgrades to device drivers
- Installation and maintenance of network operating systems (NOS)
- Installation and maintenance of programs

For the terms and conditions of the Lenovo Limited Warranty that apply to your Lenovo hardware product, go to:

- https://www.lenovo.com/warranty/llw_02
- <https://pcsupport.lenovo.com/warrantylookup>

Chapter 8. CRU replacement

This section provides instructions on how to replace Customer Replaceable Units (CRUs).

What are CRUs

Customer Replaceable Units (CRUs) are parts that can be replaced by the customer. The computers contain the following types of CRUs:

- **Self-service CRUs:** Refer to parts that can be replaced easily by customer themselves or by trained service technicians at an additional cost.
- **Optional-service CRUs:** Refer to parts that can be replaced by customers with a greater skill level. Trained service technicians can also provide service to replace the parts under the type of warranty designated for the customer's machine.

If you intend on installing a CRU, Lenovo will ship the CRU to you. CRU information and replacement instructions are shipped with your product and are available from Lenovo at any time upon request. You might be required to return the defective part that is replaced by the CRU. When return is required: (1) return instructions, a prepaid shipping label, and a container will be included with the replacement CRU; and (2) you might be charged for the replacement CRU if Lenovo does not receive the defective CRU within thirty (30) days of your receipt of the replacement CRU. For full details, see the Lenovo Limited Warranty documentation at https://www.lenovo.com/warranty/llw_02.

CRU list

This topic provides the CRU list of your computer.

Self-service CRUs

- ac power adapter*
- Power cord*

Optional-service CRUs

- Base cover assembly
- Built-in battery
- Memory module
- M.2 solid-state drive
- M.2 solid-state drive bracket
- Speaker assembly

* for selected models

Note: Replacement of any parts not listed above should be done by a qualified repair technician or by ensuring that you carefully follow all instructions provided by Lenovo. You can also find Lenovo-authorized repair facilities by going to <https://support.lenovo.com/partnerlocator> for more information.

Before you replace any CRU

Before replacing any CRU, ensure that you disable Fast Startup first and then disable the built-in battery.

Disable Fast Startup

Follow the instructions to disable Fast Startup.

- Step 1. Go to **Control Panel** and view by Large icons or Small icons.
- Step 2. Click **Power Options**, and then click **Choose what the power buttons do** on the left pane.
- Step 3. Click **Change settings that are currently unavailable** at the top.
- Step 4. If prompted by User Account Control (UAC), click **Yes**.
- Step 5. Clear the **Turn on fast startup** check box, and then click **Save changes**.

Disable the built-in battery

Follow the instructions to disable the built-in battery.

- Step 1. Restart your computer. When the logo screen is displayed, immediately press F1 to enter the UEFI BIOS menu.
- Step 2. Select **Config → Power**. The **Power** submenu is displayed.
- Step 3. Select **Disable Built-in Battery** and press Enter.
- Step 4. Select **Yes** in the Setup Confirmation window.

The built-in battery is disabled and the computer turns off automatically.

Wait three to five minutes to let the computer cool.

Note: If your computer cannot enter the UEFI BIOS menu, you cannot disable the built-in battery. To ensure safety when you replace a CRU, it is recommended to do the following:

- For the built-in battery connected to the system board with cables: Disconnect the battery cables.
- For the CRUable built-in battery connected to the system board with comb connectors: Remove the battery. For the removal procedure, refer to the built-in battery replacement instructions in this documentation.
- For the non-CRUable built-in battery connected to the system board with comb connectors: Call Lenovo Customer Support Center for help.

To check whether the built-in battery on your computer is a CRU, see the CRU list in Chapter 8 “CRU replacement” on page 96.

Replace a CRU

Follow the instructions to replace a CRU.

Base cover assembly

Follow the instructions to replace the base cover assembly.

Before you start, read [Generic Safety and Compliance Notices](#).

Notes: Do not remove the base cover assembly in the following situations. Otherwise, there might be a risk of short circuits.

- When your computer has the removable battery installed
- When your computer is connected to ac power

For access, do the following:

1. Disable Fast Startup and the built-in battery. See “Before you replace any CRU” on page 96.
2. Turn off the computer and disconnect the computer from ac power and all connected cables.
3. Close the computer display and turn over the computer.

Tools needed:

- Phillips head screwdriver
- Pry tool

Step 1. Loosen the seven captive screws and remove the base cover assembly as shown below.

Note: Prepare a pry tool to release the hooks.

- ThinkPad E14 Gen 7

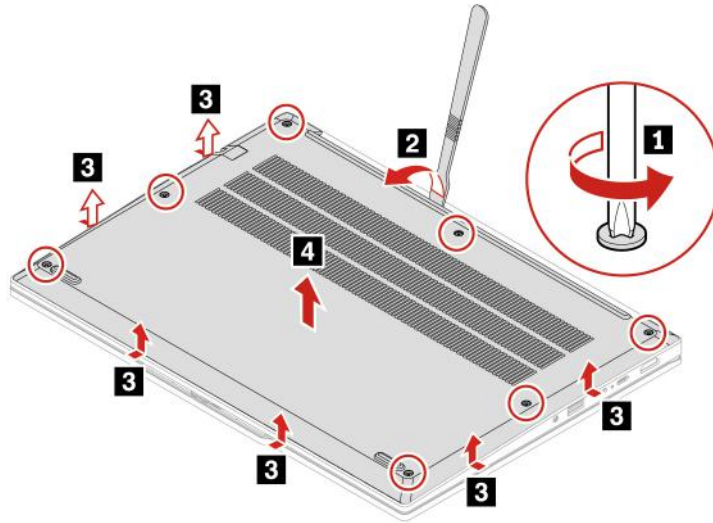

- ThinkPad E16 Gen 3

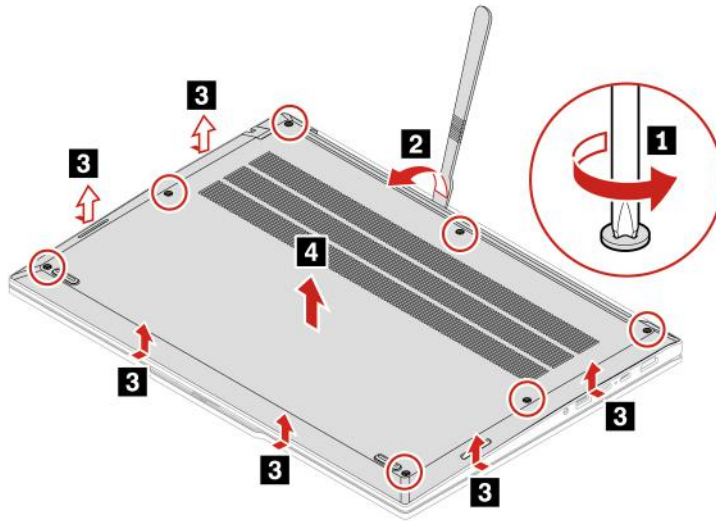

Step 2. Install the base cover assembly in reverse order.

If the computer does not start up after you reinstall the base cover assembly, disconnect the ac power adapter and then reconnect it to the computer.

Memory module

Follow the instructions to replace the memory module.

Before you start, read [Generic Safety and Compliance Notices](#).

Attention: Do not touch the contact edge of the memory module. Otherwise, the memory module might get damaged.

For access, do the following:

1. Disable Fast Startup and the built-in battery. See “Before you replace any CRU” on page 96.
2. Turn off the computer and disconnect the computer from ac power and all connected cables.
3. Close the computer display and turn over the computer.
4. Remove the base cover assembly. See “Base cover assembly” on page 97.

Step 1. Remove the memory module as shown below.

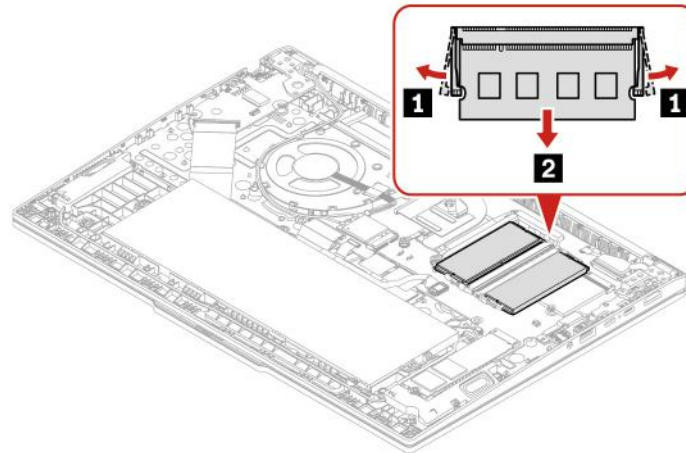

Step 2. Install the memory module as shown below.

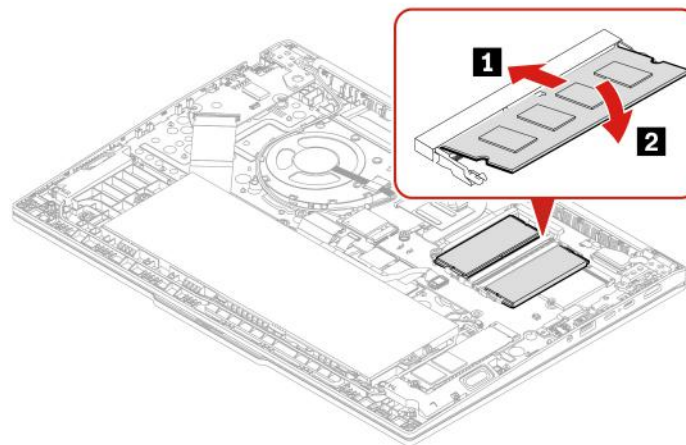

M.2 solid-state drive and M.2 solid-state drive bracket

Follow the instructions to replace the 2242 M.2 solid-state drive.

Before you start, read [Generic Safety and Compliance Notices](#).

Attention: If you replace a M.2 solid-state drive, you might need to install a new operating system. For details on how to install a new operating system, see “Install a Windows operating system and drivers” on page 75.

The M.2 solid-state drive is sensitive. Inappropriate handling might cause damage and permanent loss of data.

When handling the M.2 solid-state drive, observe the following guidelines:

- Replace the M.2 solid-state drive only for repair. The M.2 solid-state drive is not designed for frequent changes or replacement.

- Before replacing the M.2 solid-state drive, make a backup copy of all the data that you want to keep.
 - Do not apply pressure to the M.2 solid-state drive.
 - Do not touch the contact edge or circuit board of the M.2 solid-state drive. Otherwise, the M.2 solid-state drive might get damaged.
 - Do not subject the M.2 solid-state drive to physical shocks or vibration. Put the M.2 solid-state drive on a soft material, such as cloth, to absorb physical shocks.
1. Disable Fast Startup and the built-in battery. See “Before you replace any CRU” on page 96.
 2. Turn off the computer and disconnect the computer from ac power and all connected cables.
 3. Close the computer display and turn over the computer.
 4. Remove the base cover assembly. See “Base cover assembly” on page 97.

Tool needed: Phillips head screwdriver

Step 1. Loosen the captive screw and remove the M.2 solid-state drive bracket and M.2 solid-state drive as shown below.

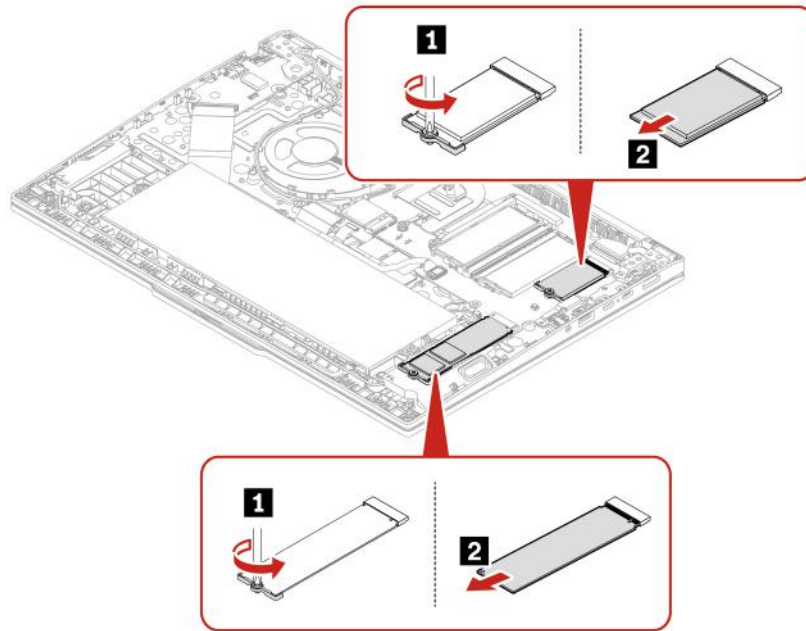

Step 2. Install the M.2 solid-state drive and its bracket as shown below. Fasten the captive screw to secure the M.2 solid-state drive.

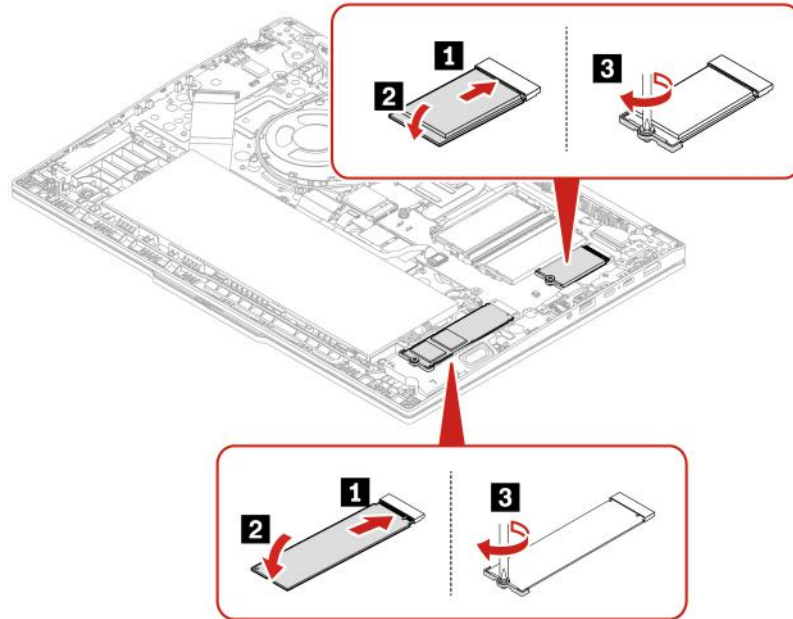

Built-in battery

Follow the instructions to replace the built-in battery.

Before you start, read [Generic Safety and Compliance Notices](#).

CAUTION:

Use only the Lenovo-authorized battery specified for the computer. Any other battery could ignite or explode.

Batteries supplied by Lenovo for use with your product have been tested for compatibility and should only be replaced with approved parts. A battery other than the one specified by Lenovo, or a disassembled or modified battery may not be covered by warranty.

Battery abuse or mishandling can cause overheating, liquid leakage, or an explosion. To avoid possible injury:

- Do not open, disassemble or service any battery unless you are competent to do so and ensure that you carefully follow all instructions provided by Lenovo.
- Do not crush or puncture the battery.
- Do not short-circuit the battery, or expose it to water or other liquids.
- Keep the battery away from children.
- Keep the battery away from fire.
- Stop using the battery if it is damaged, or if you notice any discharge or the buildup of foreign materials on the battery leads.
- Store the rechargeable batteries or products containing the rechargeable batteries at room temperature, charged to approximately 30 to 50% of capacity. We recommend that the batteries be charged about once per year to prevent overdischarge.
- Do not put the battery in trash that is disposed of in landfills. When disposing of the battery, comply with local ordinances or regulations.

- **If the battery is incorrectly replaced, there is danger of an explosion. The battery contains a small amount of harmful substances.**

Lenovo recommends you use a qualified repair technician or ensure that you carefully follow all instructions provided by Lenovo. The Lenovo-authorized repair facilities or technicians recycle Lenovo batteries according to local laws and regulations. Please do not dispose of your battery with your household waste. For recycling information go to <https://www.lenovo.com/recycling>.

Attention: Lenovo has no responsibility for the performance or safety of unauthorized batteries, and provides no warranties for failures or damage arising out of their use.

The Vantage app provides an automatic battery diagnostic test that determines if the built-in battery is defective. A built-in battery should not be replaced unless this diagnostic test shows that the battery is defective. The only exception to this is if the built-in battery is physically damaged or a customer is reporting a possible safety issue.

If the Vantage app is not installed on the computer, the customer should download and install the program to diagnose the built-in battery, before replacing a non-physically damaged built-in battery. Note that the replacement of a physically damaged built-in battery is not covered by the warranty.

For access, do the following:

1. Disable Fast Startup and the built-in battery. See “Before you replace any CRU” on page 96.
2. Turn off the computer and disconnect the computer from ac power and all connected cables.
3. Close the computer display and turn over the computer.
4. Remove the base cover assembly. See “Base cover assembly” on page 97.

Tool needed: Phillips head screwdriver

Step 1. Remove the built-in battery as shown below.

- a. Disconnect the built-in battery cable from the system board.

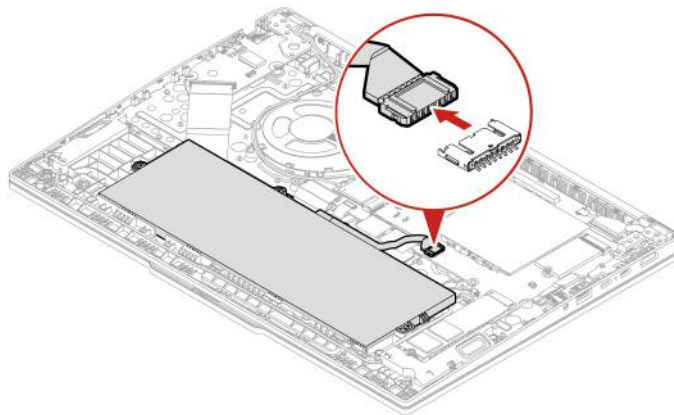

- b. Loosen the three captive screws and remove the battery as shown below.

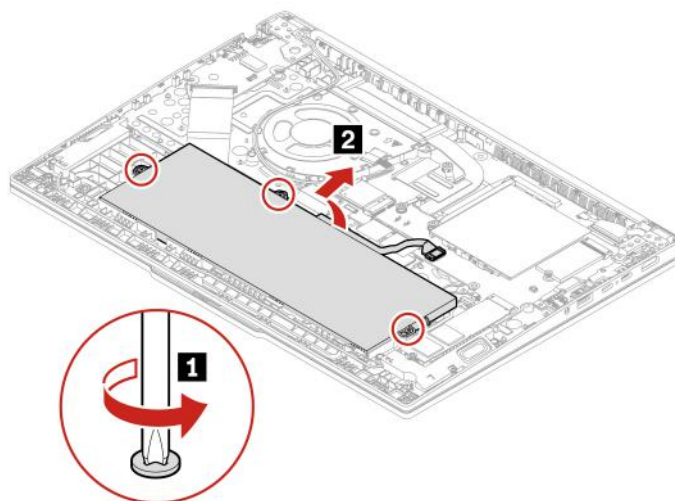

Step 2. Before installing the built-in battery, thoroughly check the battery compartment and ensure that there are no foreign or sharp objects that could cause damage to the battery.

Step 3. Install the built-in battery in reverse order.

When installing:

- Ensure that the connector is attached firmly.
- Ensure that the base cover assembly is secured in place. Otherwise, the battery connection might fail.

Speaker assembly

Follow the instructions to replace the speaker assembly.

Before you start, read [Generic Safety and Compliance Notices](#).

For access, do the following:

1. Disable Fast Startup and the built-in battery. See “Before you replace any CRU” on page 96.
2. Turn off the computer and disconnect the computer from ac power and all connected cables.
3. Close the computer display and turn over the computer.
4. Remove the base cover assembly. See “Base cover assembly” on page 97.

Step 1. Disconnect the speaker assembly cable and remove the speaker assembly as shown below.

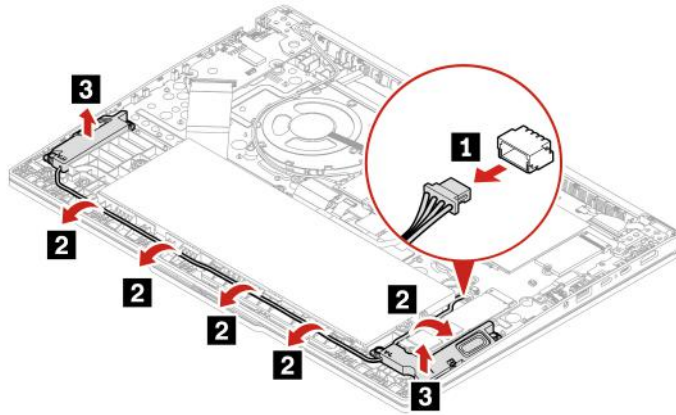

Step 2. Install the speaker assembly in reverse order.

Appendix A. Compliance information

This chapter provides the compliance information of your computer.

For compliance information, refer to *Regulatory Notice* at <https://pcsupport.lenovo.com> and *Generic Safety and Compliance Notices* at https://pcsupport.lenovo.com/docs/generic_notices.

Certification-related information

This section provides certification-related information, such as product name and machine type.

Product name	Compliance ID	Machine type(s)
ThinkPad E14 Gen 7	<ul style="list-style-type: none"> • Intel models: <ul style="list-style-type: none"> – TP00165A – TP00165A0¹ – TP00165C – TP00165C0¹ – TP00165F – TP00165F0¹ • AMD models: <ul style="list-style-type: none"> – TP00165B – TP00165B0¹ 	<ul style="list-style-type: none"> • Intel models: 21SX, 21SY, 21T9, 21TA, 21U2, and 21U3 • AMD models: 21T0 and 21T1
ThinkPad E16 Gen 3	<ul style="list-style-type: none"> • Intel models: <ul style="list-style-type: none"> – TP00166A – TP00166A0¹ – TP00166C – TP00166C0¹ • AMD models: <ul style="list-style-type: none"> – TP00166B – TP00166B0¹ 	<ul style="list-style-type: none"> • Intel models: 21SR, 21SS, 21TF, and 21TG • AMD models: 21ST and 21SU

¹ for India only

Further compliance information related to your product is available at <https://www.lenovo.com/compliance>.

Table 1. Korean Minimum Energy Performance Standard (MEPS) value (For ThinkPad E14 Gen 7)

Energy efficiency labeling	Energy efficiency information
Computer type	A
Annual power consumption (kWh)	<ul style="list-style-type: none"> • For Intel Arrow Lake models: 20 • For Intel Raptor Lake Refresh models: 11.3 • For Intel Lunar Lake models: 9 • For AMD models: 15.4

Table 1. Korean Minimum Energy Performance Standard (MEPS) value (For ThinkPad E14 Gen 7) (continued)

Energy efficiency labeling	Energy efficiency information
Power consumption in sleep mode (W)	<ul style="list-style-type: none"> • For Intel Arrow Lake models: 0.92 • For Intel Raptor Lake Refresh models: 0.91 • For Intel Lunar Lake models: 1.27 • For AMD models: 1.77
Power consumption in off mode (W)	<ul style="list-style-type: none"> • For Intel Arrow Lake models: 0.43 • For Intel Raptor Lake Refresh models: 0.22 • For Intel Lunar Lake models: 0.31 • For AMD models: 0.38

Table 2. Korean Minimum Energy Performance Standard (MEPS) value (For ThinkPad E16 Gen 3)

Energy efficiency labeling	Energy efficiency information
Computer type	A
Annual power consumption (kWh)	<ul style="list-style-type: none"> • For Intel Arrow Lake models: 20.2 • For Intel Raptor Lake Refresh models: 13.5 • For AMD models: 14.1
Power consumption in sleep mode (W)	<ul style="list-style-type: none"> • For Intel Arrow Lake models: 0.98 • For Intel Raptor Lake Refresh models: 1.02 • For AMD models: 1.59
Power consumption in off mode (W)	<ul style="list-style-type: none"> • For Intel Arrow Lake models: 0.44 • For Intel Raptor Lake Refresh models: 0.35 • For AMD models: 0.64

Locate the UltraConnect wireless antennas

Your computer has an UltraConnect™ wireless antenna system. You can enable wireless communication wherever you are.

The following illustration shows the antenna locations on your computer:



1 Wireless LAN antenna

Operating environment

This section provides information about the operating environment of your computer.

Maximum altitude (without pressurization)

3048 m (10 000 ft)

Temperature

- Operating: 5°C to 35°C (41°F to 95°F)
- Storage and transportation in original shipping packaging: -20°C to 60°C (-4°F to 140°F)
- Storage without packaging: 5°C to 43°C (41°F to 109°F)

Note: When you charge the battery, its temperature must be no lower than 10°C (50°F).

Relative humidity

- Operating: 8% to 95% at wet-bulb temperature 23°C (73°F)
- Storage and transportation: 5% to 95% at wet-bulb temperature 27°C (81°F)

Appendix B. Accessibility features

Lenovo is committed to making information technology accessible to everyone, including individuals with hearing, vision, mobility, cognitive, or speech disabilities. To get the most up-to-date and detailed accessibility features information for the product, go to https://support.lenovo.com/docs/product_accessibility_features.

Appendix C. Notice for USB connector name update

The USB Implementers Forum published a revision of the guideline for USB connector names in September, 2022. Lenovo follows the revised guideline and updates USB connector names accordingly. You can refer to the table below for naming update details.

Current name	Previous name
USB-A connector (Hi-Speed USB)	USB-A 2.0 connector
USB-A connector (USB 5Gbps)	USB-A 3.2 Gen 1 connector
USB-A connector (USB 10Gbps)	USB-A 3.2 Gen 2 connector
USB-A connector (USB 5Gbps, Always On USB)	Always on USB-A 3.2 Gen 1 connector
USB-A connector (USB 10Gbps, Always On USB)	Always on USB-A 3.2 Gen 2 connector
USB-C connector (USB 5Gbps)	USB-C (3.2 Gen 1) connector
USB-C connector (USB 10Gbps)	USB-C (3.2 Gen 2) connector
USB-C connector (USB 20Gbps)	USB 3.2 Gen 2x2
USB-C connector (USB4 20Gbps)	USB 4 Gen 2x2
USB-C connector (USB4 40Gbps)	USB-C (USB 4) connector
USB-C connector (Thunderbolt 3)	USB-C (Thunderbolt 3) connector
USB-C connector (Thunderbolt 4)	USB-C (Thunderbolt 4) connector

Appendix D. Notices and trademarks

Notices

Lenovo may not offer the products, services, or features discussed in this document in all countries. Consult your local Lenovo representative for information on the products and services currently available in your area. Any reference to a Lenovo product, program, or service is not intended to state or imply that only that Lenovo product, program, or service may be used. Any functionally equivalent product, program, or service that does not infringe any Lenovo intellectual property right may be used instead. However, it is the user's responsibility to evaluate and verify the operation of any other product, program, or service.

Lenovo may have patents or pending patent programs covering subject matter described in this document. The furnishing of this document does not give you any license to these patents. You can send license inquiries, in writing, to:

*Lenovo (United States), Inc.
8001 Development Drive
Morrisville, NC 27560
U.S.A.
Attention: Lenovo Director of Licensing*

LENOVO PROVIDES THIS PUBLICATION "AS IS" WITHOUT WARRANTY OF ANY KIND, EITHER EXPRESS OR IMPLIED, INCLUDING, BUT NOT LIMITED TO, THE IMPLIED WARRANTIES OF NON-INFRINGEMENT, MERCHANTABILITY OR FITNESS FOR A PARTICULAR PURPOSE. Some jurisdictions do not allow disclaimer of express or implied warranties in certain transactions, therefore, this statement may not apply to you.

Changes are made periodically to the information herein; these changes will be incorporated in new editions of the publication. To provide better service, Lenovo reserves the right to improve and/or modify the products and software programs described in the manuals included with your computer, and the content of the manual, at any time without additional notice.

The software interface and function and hardware configuration described in the manuals included with your computer might not match exactly the actual configuration of the computer that you purchase. For the configuration of the product, refer to the related contract (if any) or product packing list, or consult the distributor for the product sales. Lenovo may use or distribute any of the information you supply in any way it believes appropriate without incurring any obligation to you.

The products described in this document are not intended for use in implantation or other life support applications where malfunction may result in injury or death to persons. The information contained in this document does not affect or change Lenovo product specifications or warranties. Nothing in this document shall operate as an express or implied license or indemnity under the intellectual property rights of Lenovo or third parties. All information contained in this document was obtained in specific environments and is presented as an illustration. The result obtained in other operating environments may vary.

Lenovo may use or distribute any of the information you supply in any way it believes appropriate without incurring any obligation to you.

Any references in this publication to non-Lenovo Web sites are provided for convenience only and do not in any manner serve as an endorsement of those Web sites. The materials at those Web sites are not part of the materials for this Lenovo product, and use of those Web sites is at your own risk.

Any performance data contained herein was determined in a controlled environment. Therefore, the result obtained in other operating environments may vary significantly. Some measurements may have been made on development-level systems and there is no guarantee that these measurements will be the same on generally available systems. Furthermore, some measurements may have been estimated through extrapolation. Actual results may vary. Users of this document should verify the applicable data for their specific environment.

This document is copyrighted by Lenovo and is not covered by any open source license, including any Linux® agreement(s) which may accompany software included with this product. Lenovo may update this document at any time without notice.

For the latest information or any questions or comments, contact or visit the Lenovo Web site:

<https://pcsupport.lenovo.com>

Trademarks

Lenovo, Lenovo logo, ThinkPad, ThinkPad logo, and TrackPoint are trademarks of Lenovo. Intel and Thunderbolt are trademarks of Intel Corporation or its subsidiaries in the U.S. and/or other countries. Linux is the registered trademark of Linus Torvalds in the U.S. and other countries. Microsoft, Microsoft Teams, Windows, Windows Hello, BitLocker, and  are trademarks of the Microsoft group of companies. Dolby, Dolby Voice, and Dolby Atmos are trademarks of Dolby Laboratories Licensing Corporation. The terms HDMI and HDMI High-Definition Multimedia Interface are trademarks or registered trademarks of HDMI Licensing LLC in the United States and other countries. USB-C is a registered trademark of USB Implementers Forum. Wi-Fi and Miracast are registered trademarks of Wi-Fi Alliance. All other trademarks are the property of their respective owners.