



## Data Interface with SWC

### Fits Select Chrysler Models 2005-2018

#### FEATURES

- Designed for non-amplified and amplified systems
- Retains audio controls on the steering wheel
- Easy-to-set DIP Switches for SWC configuration
- Provides NAV outputs (parking brake, reverse, and speed sense)
- Provides accessory power (12-volt)
- Type "C" USB updatable
- All outputs are 250mA

**Note:** Rear seat entertainment is not retained

#### APPLICATIONS

Chrysler	Dodge cont.	RAM	Mitsubishi
200 .....2011-2014	Challenger .....2008-2014	1500/3500 .....2011-2012	Raider .....2006-2009
300/300C .....2005-2010	Charger .....2006-2010	2500 .....2012	<b>Volkswagen</b>
Aspen .....2007-2009	Dakota .....2006-2011	<b>Jeep</b>	Routan .....2009-2013
PT Cruiser .....2006-2010	Durango .....2008-2009	Commander .....2006-2010	
Sebring .....2007-2010	Durango .....2011-2013	Compass .....2007-2016	
Town & Country .....2008-2016	Grand Caravan .....2009-2016	Grand Cherokee .....2005-2013	
<b>Dodge</b>	Journey .....2009-2010	Liberty .....2008-2012	
Avenger .....2008-2014	Magnum .....2005-2008	Patriot .....2007-2016	
Caliber .....2007-2012	Nitro .....2007-2011	Wrangler .....2007-2017	
	Ram 1500/3500 .....2006-2010	Wrangler (JK only) .....2018	
	Ram 2500 .....2006-2011		

#### TABLE OF CONTENTS

Connections: Wiring Key .....	2
SWC CHART	
DIP Switch Configuration .....	3
Installation .....	4
Steering Wheel Control Configuration.....	4
Button Remapping .....	5-6
Software Update Guide.....	7

Visit [MetraOnline.com](http://MetraOnline.com) for more detailed information about the product and up-to-date vehicle specific applications

Visit our [Vehicle Fit Guide](#) for up-to-date vehicle-specific applications.

#### COMPONENTS

- MET-CH14 interface
- Vehicle-specific harness
- 3.5mm pigtail

**ATTENTION:** With the key out of the ignition, disconnect the negative battery terminal before installing this product. Ensure that all installation connections are secure before cycling the ignition to test this product.  
**NOTE:** Refer also to the instructions included with the aftermarket radio.

# WIRING CONNECTIONS & KEY

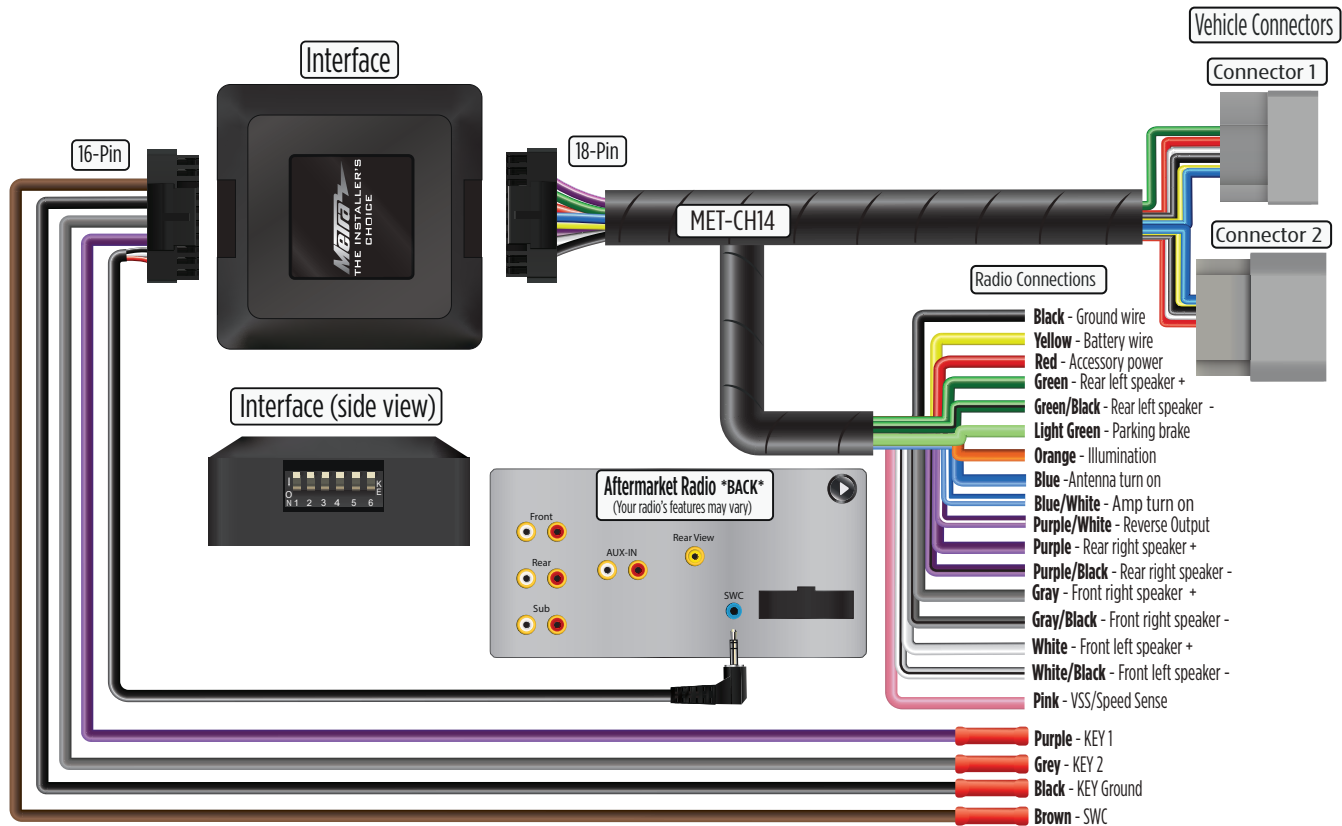

## SWC CHART: DIP SWITCH CONFIGURATION

MANUFACTURER	SYSTEM	DIP SWITCH SETTINGS				CONNECTION
		1	2	3	4	
RESERVED	NA	OFF	OFF	OFF	OFF	SOFTWARE UPDATE MODE
ALPINE	IR DATA	OFF	ON	OFF	OFF	MALE 3.5MM JACK
ANALOG SINGLE EXTEND	ANALOG	ON	ON	ON	ON	BROWN SWC IR
ANALOG SINGLE WIRE	ANALOG	ON	ON	ON	OFF	BROWN SWC IR
CLARION	IR DATA	ON	OFF	ON	ON	MALE 3.5MM JACK
CUSTOM	IR DATA	ON	OFF	ON	ON	HEAD UNIT DEPENDENT
GRUNDIG	IR DATA	OFF	ON	OFF	ON	BROWN SWC IR
JVC	IR DATA	OFF	OFF	ON	OFF	BROWN SWC IR
KENWOOD 1	IR DATA	ON	OFF	OFF	OFF	BROWN SWC IR
KENWOOD 2	IR DATA	ON	ON	OFF	OFF	BROWN SWC IR
KEY 1 / KEY 2	ANALOG	OFF	ON	ON	OFF	KEY1 / KEY 2 WIRES
KEY 1 / KEY 2 EXTEND	ANALOG	OFF	ON	ON	ON	KEY1 / KEY 2 WIRES
PHILIPS	IR DATA	OFF	ON	OFF	OFF	BROWN SWC IR
PIONEER 1	ANALOG	OFF	OFF	OFF	ON	MALE 3.5MM JACK
PIONEER 2	ANALOG	OFF	OFF	ON	ON	MALE 3.5MM JACK
SONY	ANALOG	ON	OFF	ON	OFF	MALE 3.5MM JACK

### DIP SWITCH 6

DIP SWITCH **OFF**, activates the car's OEM amplifier whenever the **ACC function** is enabled for the aftermarket radio.

DIP SWITCH **ON**, activates the car's OEM amplifier whenever the **AMP REM wire** on the loom receives a 12V signal from the aftermarket radio.

### KEY1 AND KEY2

KEY1 and KEY2 are specifically tailored for analog learning mode-style radios. Our SWC module is designed with a resistor chain that precisely matches the required resistance for seamless compatibility with this type of head unit.

### KEY1 AND KEY2 EXTEND

This mode extends every button press to 2 seconds during the learning process. However, with rolling wheel-designed steering wheel buttons, holding for 2 seconds isn't feasible. Our KEY1 and KEY2 extend feature addresses this by automatically prolonging each press, simplifying head unit programming even in such scenarios. Extend mode is not intended for normal use, it is only used in the teaching process.

### ANALOG SINGLE WIRE AND ANALOG SINGLE WIRE EXTEND

This function operates similarly to KEY1 and KEY2 but transmits all unique values through the **IR SWC single wire**. This is crucial for compatibility with learning-style head units featuring only one learning input wire. To ensure compatibility, we've incorporated this feature into our steering wheel control interface, ensuring seamless operation across various head unit setups.

The **Analog Extend** mode functions identically to its counterpart within the KEY1 and KEY2 system but transmits through a single wire.

### SWC INTERFACE

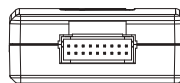

18 PIN HARNESS CONNECTOR

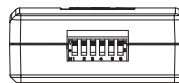

DIP SWITCHES

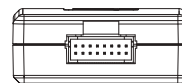

16-PIN HEAD UNIT CONNECTION LEAD

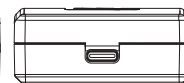

USB-C

# INSTALLATION

## Before Installation

Prior to installing the interface, it is essential to remove and disconnect the factory stereo. For guidance on this process, please refer to the vehicle owner's manual/handbook or seek assistance from a professional.

## Setting the DIP Switches

This interface includes a set of DIP Switches. Consult the DIP Switch selection guide to select the appropriate configuration. To activate a DIP Switch, press it downward into the 'ON' position. Refer to the diagram for an example of the 'KENWOOD' DIP Switch configuration. (Figure A)

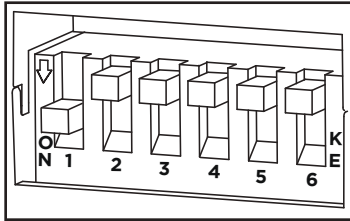

(Figure A)

## Installation

1. Take the interface, then connect the 16-PIN head unit connection lead and the 18-PIN steering wheel harness connectors to their respective ports.
2. Connect the head unit connection lead to the steering wheel remote input on the rear side of the aftermarket stereo. Connection methods vary based on the stereo brand, utilizing either a 3.5mm jack connector SWC IR wire or wired inputs KEY1 and KEY2.
3. Connect the power/speaker connector from the interface to the corresponding power/speaker connection on the aftermarket stereo.
4. Connect the vehicle-specific connector A or B from the interface harness to the corresponding connector on the vehicle harness. Use the connector that fits your vehicle, the other connector is not used.
5. Connect the wires on the harness to the rear of the stereo (if applicable).
6. Connect the antenna adapter to the vehicle's existing connection at the rear of the aftermarket stereo.
7. When installing an aftermarket reverse camera, connect the yellow RCA from the harness to the yellow RCA of the aftermarket camera. (If supported by the interface and vehicle)
8. After connecting all wires (along with any additional accessories), it's crucial to thoroughly test the stereo and steering wheel controls before reassembling the dashboard. If steering wheel controls are unresponsive, inspect connections and check DIP Switch settings. Repeat the connection process if necessary, following the outlined steps on the following pages.

# BUTTON REMAPPING

## Button Remapping for Steering Wheel Control (SWC) Interfaces

1. Set any of the six DIP Switches to **ON**. (Figure A) (All **OFF** is reserved for SW update).
2. Connect the **USB-C** cable to your PC, Mac, or smartphone, then connect it to the interface.
3. The interface will show up as a drive on the connected device and will be identified by the name **"INTERFACE"**. (Figure B)
4. Double click the drive to open it.

5. You will find a .txt file named **"Interface Configuration."** Open it. (Figure C)
6. By default, this configuration file is blank and does not contain any steering wheel control re-mapping. (Figure D)
7. Editing and saving this text file onto the interface allows you to change the functions of the buttons during normal operation.
8. **IMPORTANT:** Before you begin to edit the Configuration File, make a copy of the blank file so that you can always revert back to the original system.

*continued on next page*

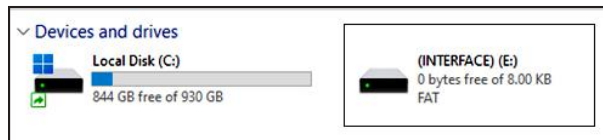

(Figure B)



(Figure C)



(Figure D)

## BUTTON REMAPPING (Cont.)

9. These steering wheel buttons can be re-configured or given two functions. The buttons available to you will depend on which car the interface is being fitted to.

The following list shows all possible buttons on all possible cars:

VOL UP	PRESET UP	OFF HOOK
VOL DOWN	PRESET DOWN	ON HOOK
TRACK UP	SOURCE	PHONE
TRACK DOWN	ATTENUATE	VOICE REC

The aftermarket radio control commands that can be assigned to them are shown below.

**Please Note:** Not all functions are supported by all aftermarket radios

VOL UP	PRESET UP	OFF HOOK
VOL DOWN	PRESET DOWN	ON HOOK
TRACK UP	SOURCE	VOICE REC
TRACK DOWN	ATTENUATE	

In addition to button remapping, we can add a dual function to each button on the steering wheel. Each button can have a short press command and a long press command assigned to it.

The length of time in milliseconds that the button needs to be held for is considered a long press can also be configured.

### Example

Here is an example of configuring the source button so that a short press performs the source function, while a long press activates voice recognition. In this example, we will set the long press hold time to 1 second (1000 milliseconds).

First, place the steering wheel button you want to configure inside square brackets:

#### [SOURCE]

Next, the text that follows will configure the actions for that button. It is crucial to maintain the exact text for button names and actions as shown at right, (Figure E) and to follow the syntax precisely as illustrated in the following example:

```
[SOURCE]
SHORT=SOURCE
LONG=VOICE_REC
HOLD_TIME=1000
```

You can repeat this process multiple times for each button you want to remap.

Note that it is not necessary to write a remap configuration for any button whose standard function you wish to keep unchanged. Finally, remember that you can only configure the steering wheel buttons that are available on your steering wheel.

10. Make sure you save the new edited **Configuration File** back onto the INTERFACE.

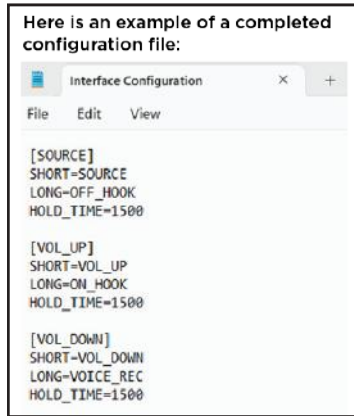

(Figure E)

# SOFTWARE UPDATE GUIDE

## Updating The Software on Your Steering Wheel Control Interfaces

1. Set all six DIP Switches to OFF. (Figure A)
2. Connect the USB-C cable to your PC, Mac, or smartphone, then connect it to the interface.
3. The interface will show up as a drive on the connected device and will be identified by the name “INTERFACE”.
4. Double click the drive to open it.
5. The system file displays the current versions of the hardware (HW) and BIOS. The other file, starting with “SWxxxx,” indicates the current software (SW) version installed on the interface. (Figure C)
6. You need to first delete the SWxxxx file.
7. Simply drag and drop, or copy, the new “SWxxx” file onto the interface. Once the file is copied, unplug the USB cable and then plug it back in.
8. The interface LED will illuminate solid for approximately 7 seconds, then it will begin to flash. Once it starts flashing, the interface will be visible as a drive on the PC again.

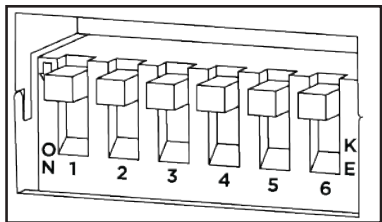

(Figure A)

9. Open the drive and verify that the “SWxxxx” file has been updated to the new version. (Figure D)

You should now have the latest software on your interface, indicating that the update was successful. At this point, you are ready to install the interface in your vehicle. Ensure that all connections are secure and follow the installation guidelines provided in the user manual. Once installed, the interface should function with the updated software.

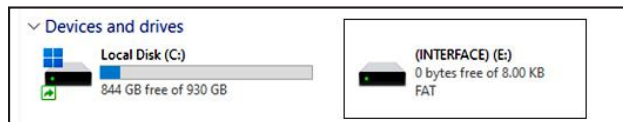

(Figure B)

Name	Date modified	Type	Size
HW-001 V3 - Bios V2 - Chk 1C65A30A.sys		System file	
SW-025 - Mercedes 83.33 FT CAN V1.00	...	Text Document	

(Figure C)

Name	Date modified	Type	Size
HW-001 V3 - Bios V2 - Chk 1C65A30A.sys		System file	

(Figure D)



# MET-CH14

INSTALLATION INSTRUCTIONS



**PRIOR TO INSTALLATION:** Installation requires a certain level of technical knowledge. Prior to installation, it is important to read the manual. Select a location for installation that is dry and free from heat sources. It is essential to use the correct tools during installation to prevent any damage to the vehicle or the product itself.

Please note that we cannot be held liable for any issues arising from improper installation. Before proceeding with installation, disconnect the negative battery terminal and ensure the key is removed from the ignition.

Having difficulties? We're here to help.



Contact our Tech Support line at:

**386-257-1187**



Or via email at:

[techsupport@metra-autosound.com](mailto:techsupport@metra-autosound.com)

### **Tech Support Hours (Eastern Standard Time)**

Monday - Friday: 9:00 AM - 7:00 PM

Saturday: 10:00 AM - 5:00 PM

Sunday: 10:00 AM - 4:00 PM



**Metra recommends MECP  
certified technicians**