



User Guide

Sound Bar

TRUE X BAR 90A

SR-X90A

EN

CONTENTS

ABOUT THIS PRODUCT AND THE USER GUIDE 8

Features	8
About items included with this product	9
About the User Guide and provided manuals	11
Notes about the safety instructions in the User Guide	11

PART NAMES AND FUNCTIONS 12

Part names of the sound bar (front/top)	12
Part names of the sound bar (rear)	14
Part names of the sound bar (front display)	15
Names of parts and functions on the front display	15
Switching the information screen on the front display	18
Part names of the subwoofer	23
Part names of the remote control	26

PREPARATION FOR USE 29

Preparation	29
Precautions for preparation	31
Preparing the remote control	34
Installing	35
Connecting to a TV	37
HDMI Connection to a TV	37
Connecting an AV device	39
Connecting an AV device to the sound bar	39
Connecting an AV device to the TV's HDMI input jack	40
Preparing to connect to a network	42
Connecting to a network	42
Connecting to a network using a LAN cable (wired connection)	43
Connecting to power	44
Turning on the sound bar	45
Confirming subwoofer connection	47

Enabling the HDMI Control function	48
Checking that the sound bar outputs audio	51
Connecting wireless speakers (TRUE X SURROUND)	53
Setting MusicCast	54
MusicCast	54
MusicCast Controller	55
Registering to a MusicCast network	56

TRUE X SURROUND **57**

What is TRUE X SURROUND?	57
TRUE X SURROUND instructions list	59
Preparations to use TRUE X SURROUND for the first time	60
Registering wireless speakers to the sound bar	60
Installing wireless speakers	69
Checking whether audio is output from the wireless speakers	71
Playback operations	74
Surround playback	74
Adjusting the volume balance	77
Playing the same audio from all speakers (ALL mode)	78
Switching between the modes (SOLO/SURROUND) of the wireless speakers	80
Removing the registration of wireless speakers to the sound bar	81
Checking the connection status	82
Checking the connection status of the wireless speakers on the sound bar	82

PLAYBACK **83**

Basic control	83
Basic control during playback	83
Playback Screen	85
Listening to TV audio	86
Listening to TV audio using eARC/ARC	86
Using a digital optical audio cable to listen to TV audio on the sound bar	87
Starting playback on a Bluetooth® device	88
Playing back audio from a Bluetooth® device	88
Playback is possible using Bluetooth® wireless speakers to listen to audio on the sound bar	90

Play back using MusicCast Controller (app)	92
Playing streaming services	92
Playing back audio files	93
Internet Radio Playback	94
Using AirPlay to playback music	95
ADJUSTING THE SOUND TO YOUR PREFERENCE	96
<hr/>	
Selecting music of your choice (Sound mode)	96
Playback with surround sound effects matching the scene (SURROUND:AI)	97
Selecting your favorite upmixer for surround playback (3D MUSIC)	98
Playback the original audio (STRAIGHT)	99
Stereo playback (STEREO)	100
Emphasizing a specific range of sound (sound settings)	101
CONFIGURATION	102
<hr/>	
Menus	102
Menu types	102
Checking playback settings and signal information (Option menu)	103
Basic operations in the Option menu	103
Option menu list	104
Automatic adjustment of high and low frequency range balance (Adaptive Volume)	105
Confirming audio signal information	106
Confirming video signal information	108
Setting auto playback	109
Set the volume linking the AirPlay playback device and the sound bar	110
Setting functions (Setup menu)	111
Basic operations of the Setup menu	111
Setup menu list	112
Configuring the speakers	115
Making audio settings	118
Making HDMI settings	121
Setting up detailed function settings (Function)	124
Setting up a network	127
Configuring the Bluetooth function	131
Language settings	133

Making settings from the sound bar (front display menu) 134

- Basic operations in the front display menu 134
- Front display menu list 135
- Adjusting the brightness of front display and the power indicator (Dimmer) 136
- Enabling/disabling the Child Lock function 137
- Initializing the sound bar 138
- Updating the firmware 139

UPDATING THE FIRMWARE 140

Firmware Update 140

Updating the firmware 141

- Updating the firmware via a network 141
- Updating the firmware with a USB flash drive 143

Front display error messages 145

TROUBLESHOOTING 146

Check the following first 146

Power and overall functionality 147

- The power turns off suddenly 147
- The power cannot be turned on 148
- No operations can be performed from the sound bar controls 149
- Front display is off when power is on (the power appears to be off) 150
- The sound bar does not function correctly 151
- The sound bar turns on even though no operation was performed 152
- The sound bar cannot be controlled with the remote control 153
- The sound bar cannot be controlled using the TV's remote control 154
- Sound bar input source not displayed on a TV 155

Audio playback 156

- No sound 156
- No sound is coming from the subwoofer 157
- The volume decreases or increases when the sound bar is turned back on 158
- No surround effect 159
- Noise is heard 160

Bluetooth® connection 161

- The sound bar cannot be connected to a Bluetooth® device 161
- No sound can be heard or the sound cuts off intermittently from a Bluetooth® device 162

Network	163
Network functions cannot be used	163
The sound bar cannot be connected to the Internet via a wireless LAN router (access point)	164
A wireless network cannot be not found	165
Audio cannot be played with AirPlay	166
The sound bar is not detected on an AirPlay-compatible device	167
Streaming services cannot be played	168
An audio file on the media server (NAS, etc.) cannot be played	169
Notification of a firmware update is not displayed	170
Use of the app	171
The app cannot detect the sound bar	171
A media server (NAS, etc.) is not detected with the app	172
TRUE X SURROUND	173
No sound is coming from both of the wireless speakers	173
No sound is coming from one of the wireless speakers	174
The volume of the connected wireless speakers is too low	175
The wireless speakers do not turn on when the sound bar is turned on	176
The registration of the wireless speakers does not complete	177
L/R cannot be selected while the wireless speakers are being registered	178
Audio content from a Bluetooth device cannot be played on the wireless speakers	179
Broken, distorted, or unusual sounds are heard	180
The sound bar and subwoofer are not connected automatically	181
How to initialize (reset)/restart the sound bar	182
To initialize (reset) the sound bar	182
Force the sound bar to restart	183
“Internal Error” appears on the front display	184
SPECIFICATIONS	185
<hr/>	
Specifications	185
Supported HDMI video signal formats	189
Supported digital audio signal formats	190

APPENDIX

192

Making a wireless connection to a network	192
Selecting a wireless connection method to a network	192
Using the WPS button to make wireless connections	193
Using iPhone to make wireless connections	194
Connecting wirelessly from a list of access points	195
Making a wireless connection manually	196
Wireless connection with PIN-code type WPS	197
Connecting a subwoofer manually	198
Trademarks	199
List of support centers	201

ABOUT THIS PRODUCT AND THE USER GUIDE

Features

This subwoofer-equipped bar-shaped speaker is designed to be connected to TV sets or other AV devices. It allows you to enjoy a highly realistic sound experience and the wide variety of content that networking functions can provide.

In addition, the product supports “TRUE X SURROUND” using wireless speakers to provide real surround sound.

About items included with this product

The following items are included with this product. Make sure that all of the included items are present.

■ Main devices

- Sound bar (SR-CUX90A)



- Subwoofer (SR-WSWX90A)



■ Accessories

- Remote control (×1)



- Batteries (AAA, LR03, UM-4) (×2)

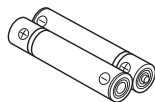

- Power cords (×2)



- Mounting brackets (×2)



ABOUT THIS PRODUCT AND THE USER GUIDE > About items included with this product

- Washers (×2)



- Quick Guide (×1)
- Safety Guide (×1)

NOTE

An HDMI cable is not included. If you intend to use an HDMI cable to connect this product, get one that is commercially available. Choose an HDMI cable according to the functions of the device to be connected.

About the User Guide and provided manuals

Notes about the safety instructions in the User Guide

- The User Guide (this guide) uses the following signal words for important safety information.



WARNING

indicates “risk of serious injury or death”.



CAUTION

indicates “risk of injury”.

NOTICE

indicates measures you must take to prevent product failure, damage or malfunction and data loss, as well as to protect the environment.

NOTE

indicates notes on instructions, restrictions on functions, and additional information that may be helpful.

- The illustrations and screens in the descriptions are for instructional purposes only.
- The company names and product names in this guide are the trademarks or registered trademarks of their respective companies.
- Various smartphones and tablet devices are collectively referred to as “smartphones”. When necessary, the type of device is specified in the explanations.
- This guide refers to the iPhone, iPad and iPod touch collectively as “iPhone”. Unless specified, “iPhone” refers to iPhone, iPad and iPod touch.
- This guide mainly explains control operations using the remote control. If operation using the controls on the sound bar itself is required, it will be explained in each case.

■ About the manuals of this product

The following guides are included with this product or are available on the Yamaha website.

Safety Guide

This document provides information necessary for the safe use of this product. Be sure to read it before use.

Quick Guide

This document describes how to install this product after purchase from opening the box and until you can enjoy the sound from a TV or other device.

User Guide (this guide)

This guide explains all functions and procedures for use, including those not covered in the Quick Guide.

PART NAMES AND FUNCTIONS

Part names of the sound bar (front/top)

This section describes the part names and functions of the front and top of the sound bar.

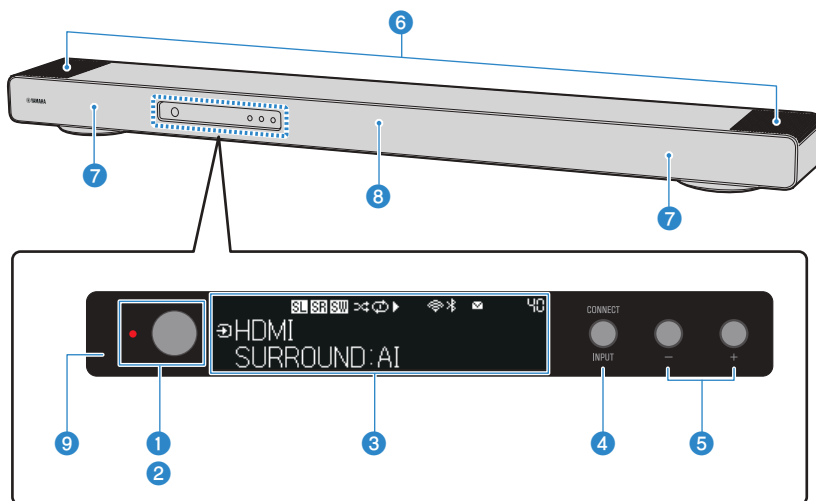

1 Power button

Turn the sound bar on and off (standby).

2 Power indicator

The power status of the sound bar is displayed as follows.

Off: When the power is on, the light is off.

On: Glows in either of the following states when power is off.

- When HDMI Control is enabled (p.121)
- When HDMI Pass Through is enabled (p.121)
- When Network Standby is enabled (p.127)
- When True X Ready is enabled (p.124)

3 Front display

Displays information and menus.

4 INPUT/CONNECT button

Select the input source or register MusicCast network (p.83, p.56).

5 VOL +/- buttons

Adjust the volume.

- 6 **Height speakers**
- 7 **Front speakers**
- 8 **Center speaker**
- 9 **Remote control sensor**

NOTE

- Text may become difficult to read when the temperature of the LCD display is very high or low, this is a characteristic of LCD displays and not indicative of a malfunction.
- Enabling the Child Lock prevents accidental operation.
- Use the Dimmer to adjust the brightness of the power indicator and the front display.

Related links

- “Enabling/disabling the Child Lock function” (p.137)
- “Adjusting the brightness of front display and the power indicator (Dimmer)” (p.136)
- “Part names of the sound bar (rear)” (p.14)
- “Names of parts and functions on the front display” (p.15)
- “Part names of the remote control” (p.26)

Part names of the sound bar (rear)

This section describes the part names and functions on the rear of the sound bar.

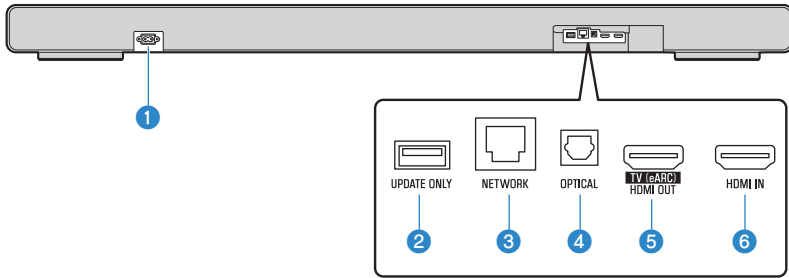

1 AC power input jack

Use to connect the power cord of the sound bar.

2 UPDATE ONLY jack

Use this jack only to update the sound bar's firmware using a USB flash drive.

See "Firmware Update" (p.140) for details on how to download and update the firmware.

3 NETWORK jack

Connect a cable to this jack and to connect the sound bar to a network (p.43).

4 OPTICAL jack

If not using the ARC or eARC functions, use an HDMI cable (commercially available) and a digital optical audio cable (commercially available) to connect to the TV (p.37).

The digital optical audio cable transmits the TV's audio signal to the sound bar.

5 HDMI OUT/TV (eARC) jack

Connect a TV with an HDMI input. Video and audio are output. When using eARC/ARC, audio from the TV is input (p.37).

6 HDMI IN jack

Connect an AV device with an HDMI output. Video and audio are Input (p.39).

Related links

- "Part names of the sound bar (front/top)" (p.12)
- "Part names of the sound bar (front display)" (p.15)
- "Part names of the remote control" (p.26)
- "Firmware Update" (p.140)

Part names of the sound bar (front display)

Names of parts and functions on the front display

This section describes the names and functions of the parts of the front display.

■ Normal display

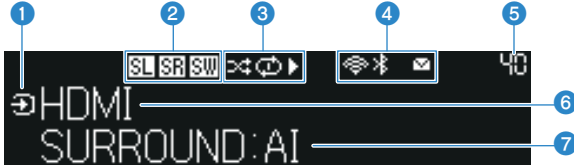

1 Mode icon

Displays the modes (input display, information screen selection) of the front display.

: Glows when in input display mode.

: Glows when in information screen selection mode.

2 Icons indicating connected speaker

The following icons glow when surround speakers or a subwoofer is connected.

: Glows when the left surround speaker is connected.

: Glows when the right surround speaker is connected.

: Glows when only one surround speaker is connected.

: Glows when a subwoofer is connected.

The following icons glow when the surround speakers and subwoofer connected to the sound bar are turned off. Glows only when the surround speakers or subwoofer are connected to the power.

: Glows when the left of the connected surround speakers is turned off.

: Glows when the right of the connected surround speakers is turned off.

: Glows when only one of the connected surround speakers is turned off.

: Glows when a connect subwoofer for some reason is turned off. When this icon glows, disconnect the power plug of the subwoofer momentarily before reconnecting it to check that it is connected to the sound bar.

3 Playback status icons

: Glows when Shuffle playback is selected.

: Glows when Repeat (All Tracks) playback is selected.

: Glows when Repeat (1 Track) playback is selected.

: Glows during playback.

: Glows when playback is paused.

: Glows when playback is stopped.

4 Status icons

 (Wireless LAN): Glows when connected to a wireless network. Flashing starts while WAC* and MusicCast network are in registration mode.

 (Bluetooth): Glows when a Bluetooth device is connected.

 : Glows when a firmware update has become available.

* WAC (Wireless Accessory Configuration) is a feature that applies the wireless settings of an iOS device to another device and wirelessly connects it to the network.

5 Volume

Displays the volume.

6 Main information display area

Displays the name of the current input, the name of the display item of input information, etc. depending on the display mode of the front display.

7 Additional information display area

Displays additional input information (sound mode name, output channel information, etc.).

Menu display



1 Menu mode

Glows when the front display menu is opened.

2 Menu level

Displays the name of the current level of the hierarchical front display menu.

3 Menu item

Displays front display menu item or set value.

4 Cursor indicator

Displays cursor operations of right menu items or set values.

NOTE

The front display example shown here is an English screen.

Related links

- “Part names of the sound bar (front/top)” (p.12)
- “Switching the information screen on the front display” (p.18)
- “Part names of the remote control” (p.26)
- “Basic operations in the front display menu” (p.134)

Switching the information screen on the front display

The information screen on the front display shows additional information on selected inputs.



Name of displayed screen

Press the INFO key on the remote control to open the information selection screen on the front display. Use the INFO key to switch between display screens. The bottom of displayed screens show information on displayed items.

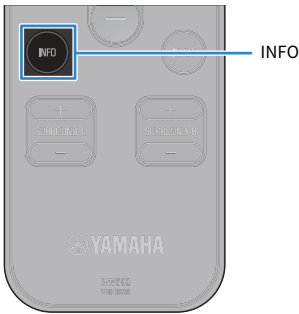

Displayed screens vary with input.

Input	Displayed screen	
HDMI		
TV	Sound mode, audio decoder, output channel, HDMI status, system status	
OPTICAL		
NET (network) type input	SERVER Amazon Music AirPlay	Played back track, played back artist, played back album, IP address, MAC address (Ethernet), MAC address (Wi-Fi), sound mode, audio decoder, output channel, HDMI status, system status
	NET RADIO	Broadcasting station, IP address, MAC address (Ethernet), MAC address (Wi-Fi), sound mode, audio decoder, output channel, HDMI status, system status, played back track, played back album
	Spotify	Information, played back track, played back artist, played back album, IP address, MAC address (Ethernet), MAC address (Wi-Fi), sound mode, audio decoder, output channel, HDMI status, system status
	Deezer Qobuz TIDAL Connect	Played back track, played back artist, played back album, IP address, MAC address (Ethernet), MAC address (Wi-Fi), sound mode, audio decoder, output channel, HDMI status, system status
	MusicCast Link	Sound mode, audio decoder, output channel, HDMI status, system status, IP address, MAC address (Ethernet), MAC address (Wi-Fi)
	SiriusXM*	Played back track, played back artist, played back channel, IP address, MAC address (Ethernet), MAC address (Wi-Fi), sound mode, audio decoder, output channel, HDMI status, system status
	Pandora*	Played back track, played back album, broadcasting station, IP address, MAC address (Ethernet), MAC address (Wi-Fi), sound mode, audio decoder, output channel, HDMI status, system status
Bluetooth	Played back track, played back artist, played back album, sound mode, audio decoder, output channel, HDMI status, system status	

* U.S.A. and Canada models only.

NOTE

- These services may not be available in some regions.
- The front display returns to normal display after 5 seconds of inaction.
- The front display example shown here is an English screen.

■ Sound mode

The selected sound mode (SURROUND:AI/3D MUSIC/STEREO/STRAIGHT/ALL) is displayed.

■ Audio decoder

Name of CODEC and decoder is displayed.

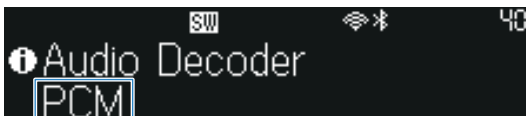

■ Output channels

The channel of output sound and level meter are displayed.

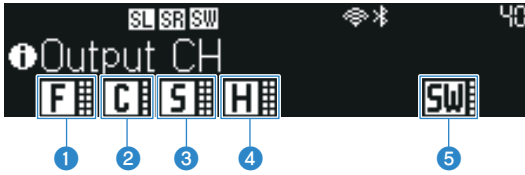

1 Front speaker, front left and right level meters

F glows when sound is output from the front speakers.

 shows audio levels for the right and left speakers.

2 Center speaker, center level meter

C glows when sound is output from the center speaker.

 shows the audio level for the center speaker.

3 Surround speakers, surround L/R level meters

S glows when sound is output from the surround speakers.

 shows audio levels for the right and left surround speakers. If there is only one surround speaker, only one level meter is displayed.

4 Height speakers, height left and right level meters

H glows when sound is output from the height speakers.

 shows audio levels for the right and left height speakers.

5 Subwoofer, subwoofer level meter

SW glows when sound is output from the subwoofer.

 displays the audio level of the subwoofer.

An underline is displayed if no sound is output.



If the surround speakers and the subwoofer are not registered, no underline is displayed.



■ HDMI status

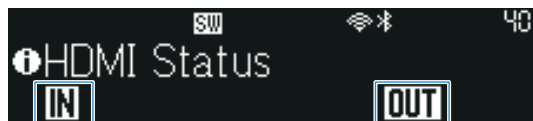

Indicates whether an input or output signal has been made to the HDMI IN, HDMI OUT/TV (eARC) jack.

IN: HDMI input

OUT: HDMI output

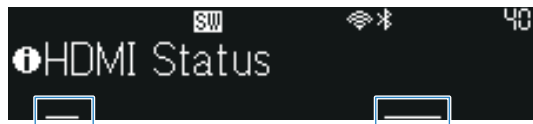

An underline is displayed if no sound is output.

■ System status

Indicates the functional status of the overall system.



MASTER: Glows when operating as the parent unit of the MusicCast network (and is the link master).



An underline is displayed if it is not the link master.

■ Short messages

Short messages are displayed during sound bar operations, for example, when selecting inputs or adjusting the volume.

When the operation is completed, the message disappears after a few seconds.

The following figure is an example of a message made during volume adjustment.

PART NAMES AND FUNCTIONS > Part names of the sound bar (front display)

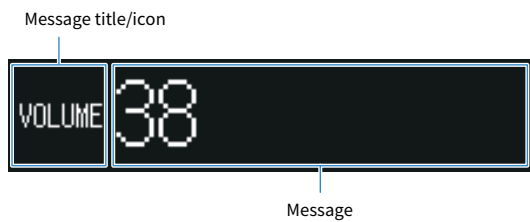

Pressing keys or buttons that are not available causes the message “Not Available” to appear.

Related links

- “Names of parts and functions on the front display” (p.15)
- “Part names of the remote control” (p.26)

Part names of the subwoofer

This section describes the part names and functions of the subwoofer.

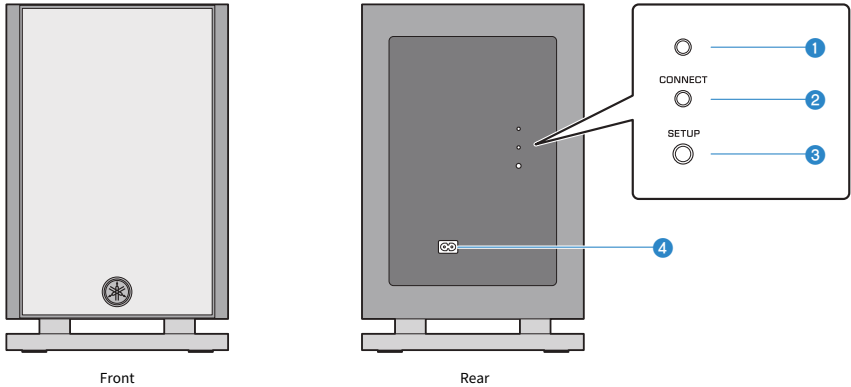

1 Power indicator

Indicates the status of the subwoofer.

For details, refer to “Information displayed by the indicators of the subwoofer” below.

2 CONNECT indicator

Indicates the connection status of the sound bar and the subwoofer.

For details, refer to “Information displayed by the indicators of the subwoofer” below.

3 SETUP button

Use to manually connect the subwoofer to the sound bar (p.198).

4 AC power input jack

Use to connect the power cord of the subwoofer.

Information displayed by the indicators of the subwoofer

NOTE

This guide shows indicator glowing status as follows:



Off



Glows



Flashes

Connecting to the sound bar

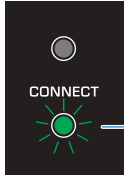

Flashes slowly (searching)
Flashes rapidly (ready to accept registration to the sound bar)

Power off state (standby)

Connection to the sound bar is established



When in power off state

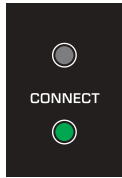

When in power on state

Connection to the sound bar has been terminated



Flashes slowly (searching)

Power on state

Flashes slowly for 30 seconds, the power is being turned off.

The time period set for registration has timed out



Flashes rapidly (2.5 times/sec)

Protection circuitry has been activated



Flashes very rapidly (5 times/sec)

Related links

- “Names of parts and functions on the front display” (p.15)
- “Connecting a subwoofer manually” (p.198)
- “Connecting to power” (p.44)
- “Turning on the sound bar” (p.45)

Part names of the remote control

This section describes the part names and functions of the remote control.

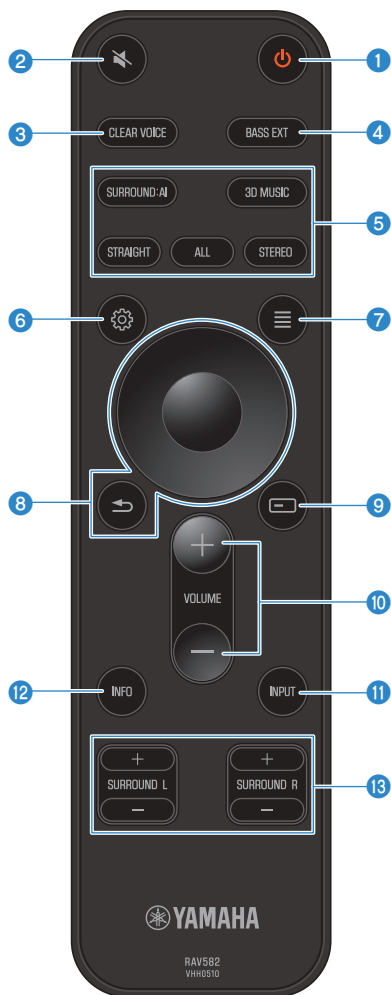

- 1** **⏻ (Power) key**
Turns the sound bar on and off (standby) (p.45).
- 2** **🔇 (Mute) key**
Mutes and unmutes the sound (p.83).

3 CLEAR VOICE key

Enables or disables the Clear Voice function (p.101).

4 BASS EXT key

Enables or disables the Bass Extension function (p.101).

5 Sound mode keys

Switches sound modes (p.96).

6  (Setup) key

Opens the Setup menu used on the TV screen (p.111).

7  (Option) key

Opens the Option menu used on the TV screen (p.103).

8 ENTER/Cursor, ⇨ (Return) key

Displays menu operations at the top of the TV screen or on the front display.
The TV screen refers to the ENTER key as the “ENTER  key”.

9  (Front Display Menu) key

Displays the front display menu (p.134).

10 VOLUME +/- keys

Adjusts the volume (p.83).

11 INPUT key

Selects the input source you want to play back (p.83).

12 INFO key

Switches the front display between showing the type of audio signal being played back and other sound bar information (p.18).

13 SURROUND L/R +/- keys

Adjusts the volume of the surround speakers (p.77).

When only one surround speaker is used, you can use either the L or R keys of SURROUND L/R to adjust the volume of the surround speaker.

■ Remote control operating range

The operating range of the remote control is shown in the following illustration.

Use remote control by pointing it at the remote control sensor.

PART NAMES AND FUNCTIONS > Part names of the remote control

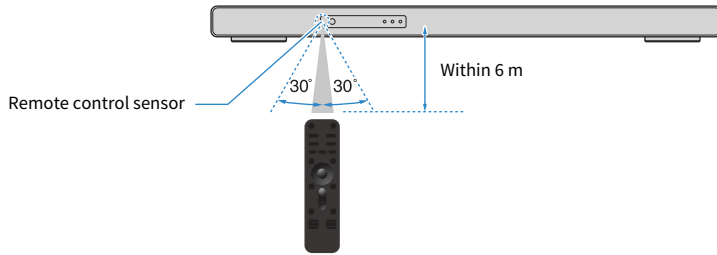

Related links

- “Part names of the sound bar (front/top)” (p.12)
- “Names of parts and functions on the front display” (p.15)
- “Switching the information screen on the front display” (p.18)

PREPARATION FOR USE

Preparation

1 Prepare the remote control.

“Preparing the remote control” (p.34)

2 Install the sound bar and subwoofer.

“Installing” (p.35)

3 Connect the sound bar to a TV.

Connect the sound bar to the TV using a method suitable for the type of jacks on the TV and the functions to be used.

“HDMI Connection to a TV” (p.37)

4 Connect an AV device. (if needed)

“Connecting an AV device to the sound bar” (p.39)

“Connecting an AV device to the TV’s HDMI input jack” (p.40)

5 Preparing for network connection. (Cable connection to a network)

“Connecting to a network using a LAN cable (wired connection)” (p.43)

6 Connect to power.

“Connecting to power” (p.44)

7 Turn on the sound bar.

When the sound bar is turned on, the subwoofer is registered at the same time.

“Turning on the sound bar” (p.45)

8 Check a subwoofer connection.

“Confirming subwoofer connection” (p.47)

9 Enables the HDMI Control function. (if needed)

“Enabling the HDMI Control function” (p.48)

10 Check that the sound bar outputs audio.

“Checking that the sound bar outputs audio” (p.51)

11 Connect TRUE X SURROUND wireless speakers. (if needed)

“Registering wireless speakers to the sound bar” (p.60)

12 Connect to a MusicCast network.

“Registering to a MusicCast network” (p.56)

NOTE

Refer to the “TRUE X SURROUND” section in this guide for instructions on how to use TRUE X SURROUND.

Precautions for preparation

Before installing the sound bar and connecting other devices, be sure to read the following precautions. Be sure to follow the precautions.

■ Precautions for remote control batteries

Before inserting batteries in the remote control, be sure to read the following precautions. Be sure to follow the precautions.



WARNING

- Do not dispose of a battery in fire. Do not expose a battery to high temperatures, such as direct sunlight or a fire. Do not attempt to charge the battery installed in the remote control. The battery could burst or leak, causing a fire or injury.
- Do not disassemble a battery. If the battery leaks, avoid contact with the leaked fluid. If the contents of the battery get on your hands or in your eyes, it can cause blindness or chemical burns. If the battery fluid should come in contact with your eyes, mouth, or skin, wash immediately with water and consult a doctor.



CAUTION

- Do not use a battery other than the specified one. Doing so may cause fire or burns, or result in fluid leakage that may cause skin inflammation.
- Always make sure the battery is inserted in conformity with the +/- polarity markings. Failure to do so might result in a fire, burns, or inflammation due to fluid leaks.
- When the battery runs out, or if the sound bar is not to be used for a long time, remove the battery from the remote control to prevent possible leakage of the battery fluid.
- Do not put in a pocket or bag, carry, or store batteries together with pieces of metal. The battery could short, burst, or leak, causing a fire or injury.
- When storing or discarding batteries, insulate the terminal area by applying tape, or some other protection. Mixing them with other batteries or metal objects can cause a fire, burns, or inflammation due to fluid.

NOTICE

- Batteries have been provided to enable the user to confirm that the device works. Since those batteries may have lost power in storage, replace them as soon as you have confirmed that the device is operational.

■ Precautions for installation



WARNING

- Install as instructed in the User Guide. Failure to observe this may cause devices to fall and result in injury.
- Confirm that the finished installation is safe and secure. Also, carry out safety inspections periodically. Failure to observe this may cause devices to fall and result in injury.
- Do not expose the product to rain, use it near water or in damp or wet conditions, or place on the product any containers (such as vases, bottles or glasses) containing liquids which might spill into any openings or places where water may drop. A liquid such as water getting into the product may cause a fire, electric shocks, or malfunctions.
- Do not place any burning items or open flames near the product, since they may cause a fire.
- Do not use this product near medical devices or inside medical facilities. Radio waves from this product may affect electro-medical devices.



CAUTION

- Do not place the product in an unstable position where it might accidentally drop, or fall over and cause injuries.
- When installing this product, do not obstruct heat dissipation. Failure to observe this may trap heat inside the product, causing a fire or malfunctions.
- Avoid being near the product during a disaster, such as an earthquake. Since the product may turn over or fall and cause injury, quickly move away from the product and go to a safe place.

NOTICE

- Do not install the product in places where it may come into contact with corrosive gases or salt air, or places that have excessive smoke or steam. Doing so may result in malfunction.
- Do not press hard on the speaker units or fabric-covered portion of this product.
- Do not place any objects susceptible to magnetism (such as a hard disk drive or magnetic card) near the product. The magnetic effect of the sound bar may cause damage to the object or its recorded data.
- Do not use this product in a location that becomes extremely hot, such as in direct sunlight or near a heater, or that becomes extremely cold, or that is subject to excessive dust or vibration. Failure to observe this may cause this product's panel to become deformed, the internal components to malfunction, or for operation to become unstable.
- If using a wireless function, avoid installing this product near metal walls or desks, microwave ovens, or other wireless network devices. Obstructions could shorten the transmission distance.
- Do not stack the sound bar and subwoofer directly on top of one another. Also, do not stack other AV devices directly on or under this product. These devices may malfunction due to vibrations.
- Do not place the subwoofer in the following ways. Doing so may cause a loss in bass sound volume.
 - With the speaker units (fabric-covered portion) placed tightly against the wall
 - With the bass reflex port blocked
- The subwoofer is designed to be placed upright. Do not lay it on its side.
- Do not place furniture or other objects made of metal between the sound bar and subwoofer. Doing so may interfere with the wireless connection.

■ Precautions for connections



WARNING

- Use this product with the power supply voltage printed on it. Failure to observe this may cause a fire, electric shocks, or malfunctions.
- Be sure to use the supplied power cord. Do not use the supplied power cord for other devices. Failure to observe this may cause a fire, electric shocks, or malfunctions.
- Never insert or remove an electric plug with wet hands. Do not handle this product with wet hands. Failure to observe this may cause electric shocks or malfunctions.
- Do not touch the power plug or cord if there is a chance of lightning. Failure to observe this may cause electric shocks.
- When setting up the product, make sure that the AC outlet you are using is easily accessible. If some trouble or malfunction occurs, immediately turn off the power switch and disconnect the plug from the AC outlet. Even when the power switch is turned off, as long as the power cord is not unplugged from the wall AC outlet, the product will not be disconnected from the power source.
- If not using the product for long periods of time, be sure to pull the power plug from the AC outlet. Failure to observe this may cause a fire or malfunctions.
- Check the electric plug periodically and remove any dirt or dust which may have accumulated on it. Failure to observe this may cause a fire or electric shocks.



CAUTION

- Do not use an AC outlet where the power plug fits loosely when inserted. Failure to observe this may cause a fire, electric shocks, or burns.
- When disconnecting the power plug, always hold the plug itself and not the cord. Pulling by the cord can damage it and cause electric shocks or a fire.
- Insert the power plug firmly all the way into the AC outlet. Using the product when it is not plugged in sufficiently can cause dust to accumulate on the plug, causing a fire or burns.

NOTICE

- If connecting external devices, be sure to thoroughly read the User Guide for each device and connect them in accordance with the instructions. Failure to properly handle a device in accordance with the instructions could cause malfunctions.
- Do not connect this product to industrial devices. This product has been designed to connect to consumer-use devices. Connection to an industrial-use device could cause this product to malfunction.

Preparing the remote control

- Before inserting batteries in the remote control, be sure to read the following precautions.
 - “Precautions for preparation” (p.31)

Install the provided batteries in the remote control, taking care to orient the (+) plus and (-) minus poles correctly.

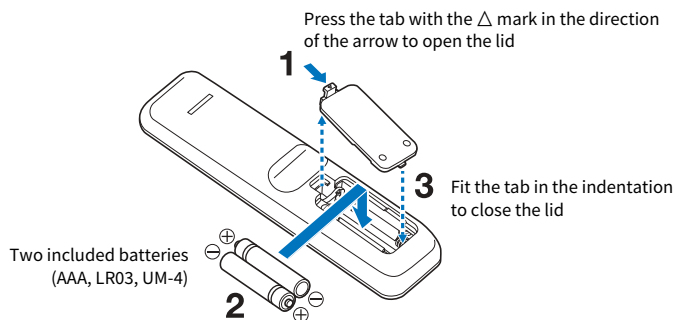

Next steps

- “Installing” (p.35)

Installing

- Before installing the sound bar, be sure to read the following precautions.
 - “Precautions for preparation” (p.31)

The following diagram is an example of how to install the sound bar and subwoofer. Place the subwoofer to the side of the sound bar. If you notice that sound bouncing off walls has a negative effect on the sound due to subwoofer orientation, turning the front of the subwoofer slightly inwards may improve the sound.

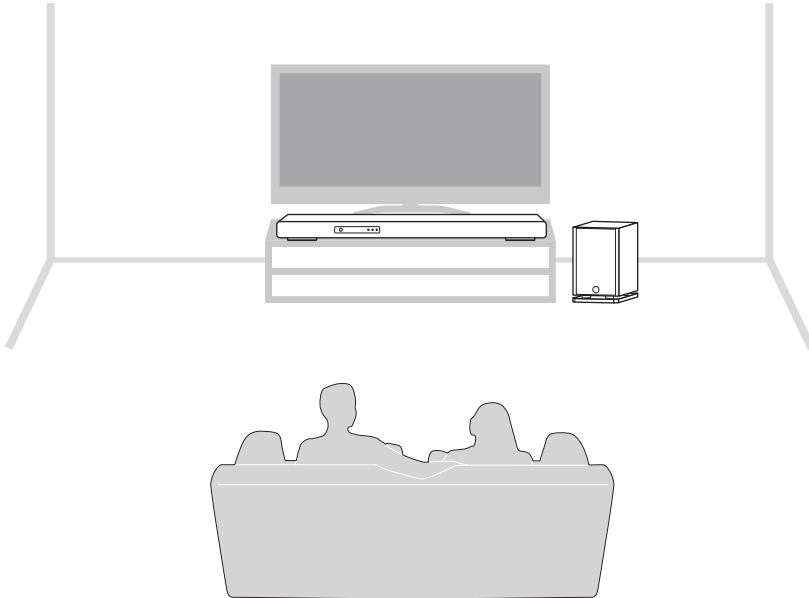

NOTICE

- The top of the sound bar is equipped with built-in height speakers that output the sound of the height channels. Provide some space above the top of the sound bar to ensure unobstructed output of the height channels. This will provide you the best possible surround sound field.

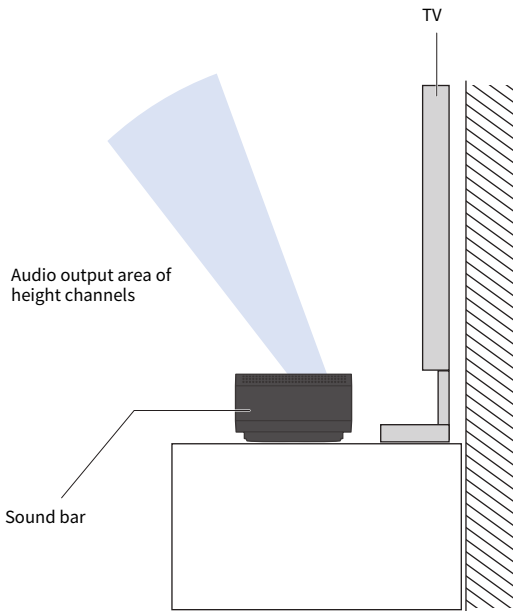

NOTE

The sound bar can also be mounted on a wall. For proper installation of the sound bar on a wall, make sure to have the work done by the dealer from where you purchased the unit or by a contractor with qualified service personnel. For more information, visit the following website.

https://manual.yamaha.com/audio/sound_bar/wallmount/sr-x90a/

Next steps

- "HDMI Connection to a TV" (p.37)

Connecting to a TV

HDMI Connection to a TV

- Before connecting devices, be sure to read the following precautions.
 - “Precautions for preparation” (p.31)

NOTE

- Use a 19-pin HDMI cable with an HDMI logo.
- Use an HDMI cable that is as short as possible to prevent any degradation in signal quality.
- When using the eARC/ARC function, use an HDMI cable that supports eARC/ARC, such as a high-speed HDMI cable that is compatible with Ethernet.
- For playback of 3D and 4K Ultra HD video, use a Premium High Speed HDMI cable or a Premium High-Speed HDMI cable with Ethernet.
- These connections may require additional settings on the TV. For details, see the instruction manual supplied with your TV.

■ Using the eARC/ARC function

If your TV supports the eARC or ARC function, you only need one HDMI cable to output TV audio to the sound bar. To use the ARC function, you have to turn On the HDMI Control function.

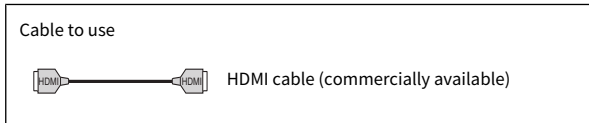
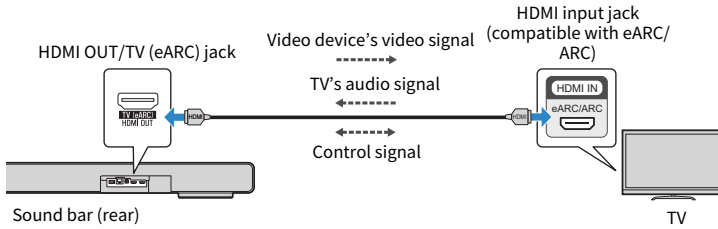

NOTE

- ARC is an abbreviation for Audio Return Channel. By connecting the ARC-compatible HDMI input jack on the TV to the ARC-compatible HDMI output jack on an AV device (such as the sound bar or an AV receiver) via an HDMI cable, audio from the TV can be played back on the AV device without using an optical cable.
- eARC is an abbreviation for Enhanced Audio Return Channel. It is an extension of ARC functionality and is capable of transmitting object-based audio signals such as uncompressed 5.1ch, 7.1ch via a TV.

■ Connecting a digital optical audio cable

Use a digital optical cable (commercially available) to connect to a TV not supporting eARC or ARC.

The HDMI cable transmits the control signal for controlling the sound bar using the TV remote control (HDMI Control function). When an AV device is connected to the HDMI IN jack on the sound bar, the video signal is transmitted to the TV. To use the HDMI Control function, set the sound bar HDMI Control function to On.

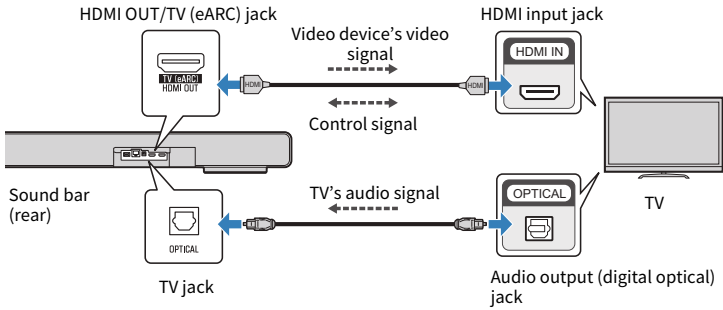

Cable to use



Digital optical audio cable (commercially available)



HDMI cable (commercially available)

Next steps

- If connecting an AV device:
 - “Connecting an AV device to the sound bar” (p.39)
 - “Connecting an AV device to the TV’s HDMI input jack” (p.40)
- If not connecting an AV device:
 - Connect cable to a network:
“Connecting to a network” (p.42)
 - Making a wireless connection to a network:
“Connecting to power” (p.44)

Connecting an AV device

Connecting an AV device to the sound bar

- Before connecting devices, be sure to read the following precautions.
 - “Precautions for preparation” (p.31)

Connect an AV device (such as a Blu-ray Disc player or a set top box) to the sound bar using an HDMI cable (commercially available).

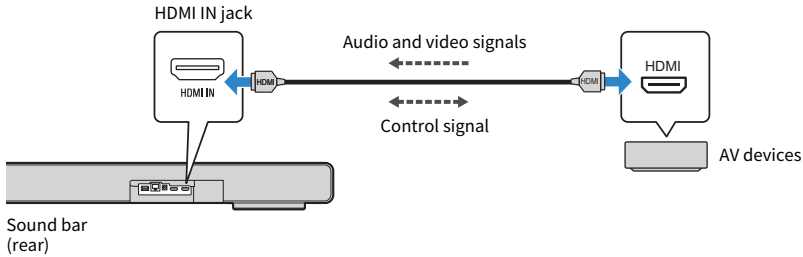

Cable to use

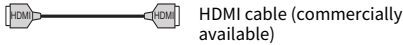

NOTE

- To play audio from an AV device via the sound bar, set the input sources as follows:
 - Sound bar's input source: HDMI
- In the sound bar's Setup menu, under "HDMI", set "Pass Through" to "On" or "Auto" to play back video and audio from an AV device on a TV even when the sound bar is turned off (HDMI signal pass-through). The default setting is "Auto".
- Use a 19-pin HDMI cable with an HDMI logo.
- Use an HDMI cable that is as short as possible to prevent any degradation in signal quality.
- For playback of 3D and 4K Ultra HD video, use a Premium High Speed HDMI cable or a Premium High-Speed HDMI cable with Ethernet.

Next steps

- Cable connection to a network:
 - “Connecting to a network” (p.42)
- Wireless connection to a network:
 - “Connecting to power” (p.44)

Related links

“Connecting an AV device to the TV's HDMI input jack” (p.40)

Connecting an AV device to the TV's HDMI input jack

- Before connecting devices, be sure to read the following precautions.
 - "Precautions for preparation" (p.31)

Connect AV devices (such as Blu-ray Disc players or set top boxes) to the TV using an HDMI cable (commercially available) to play music from the sound bar. Use this method to connect multiple AV devices for playback.

Depending on your TV, the high-definition audio signals input from the AV device may be converted to other audio signals before transmission. In order to reproduce sound that makes the most of the characteristics of the audio signals output from the AV device, connect it to the HDMI IN jack on the sound bar.

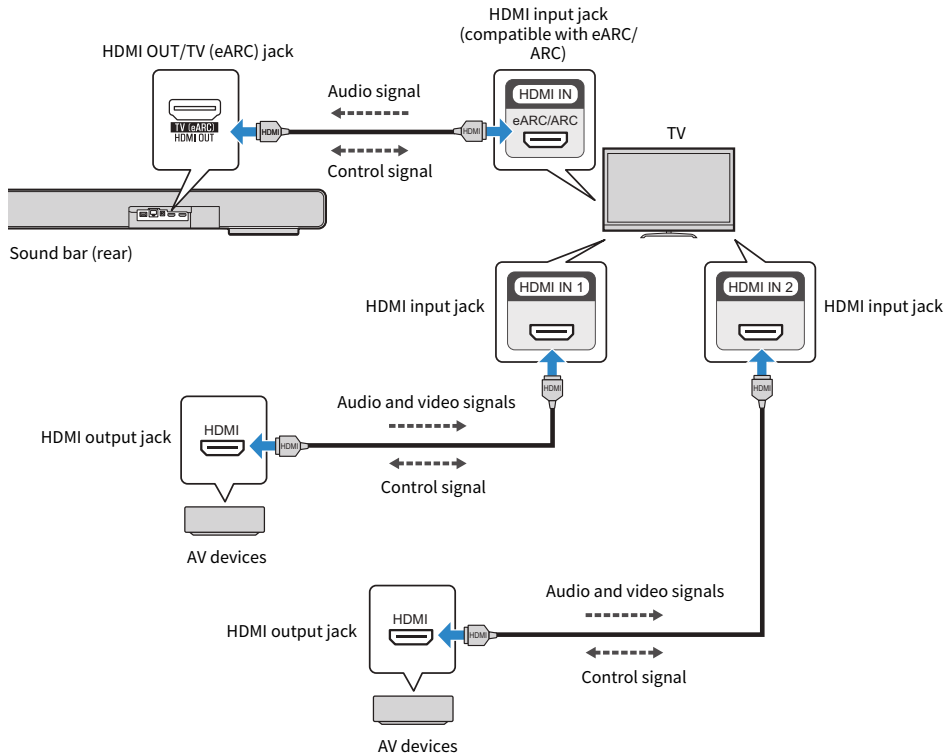

Cable to use



HDMI cable (commercially available)

NOTE

- To play audio from an AV device via the sound bar, set the input sources as follows:
 - Sound bar input source: TV (HDMI OUT/TV (eARC))
 - TV's input source: AV device playing the content
- ARC is an abbreviation for Audio Return Channel. By connecting the ARC-compatible HDMI input jack on the TV to the ARC-compatible HDMI output jack on the sound bar or an AV receiver via an HDMI cable, audio from the TV can be played on the sound bar or AV receiver without using an optical cable.
- eARC is an abbreviation for Enhanced Audio Return Channel. It is an extension of the ARC functionality and is capable of transmitting audio signals via a TV that ARC cannot transmit.
- When the sound bar is connected to an ARC-compatible HDMI input jack on the TV, turn On the HDMI Control function on the sound bar.
- Use a 19-pin HDMI cable with an HDMI logo.
- Use an HDMI cable that is as short as possible to prevent any degradation in signal quality.
- To use the eARC or ARC function, use an eARC/ARC-compatible HDMI cable such as an Ethernet-supporting High Speed HDMI cable.
- For playback of 3D and 4K Ultra HD video, use a Premium High Speed HDMI cable or a Premium High-Speed HDMI cable with Ethernet.

Next steps

- Cable connection to a network:
 - “Connecting to a network” (p.42)
- Wireless connection to a network:
 - “Connecting to power” (p.44)

Related links

“Connecting an AV device to the sound bar” (p.39)

Preparing to connect to a network

Connecting to a network

The sound bar supports wired and wireless connections.

When connected to a network, you can use network functions and update firmware over the network.

Use of network functions requires a registration with the “MusicCast Network” and use the “MusicCast Controller” smartphone application.

On the sound bar you can play back music files stored on various streaming services and media servers such as network attached storage (NAS) from MusicCast Controller.

Register with a MusicCast network after turning on the sound bar. While you make a registration, you can also make a wireless connection. For details, refer to the following link.

If you wish to use the network via a wired connection, connect a LAN cable to the sound bar before turning on the sound bar. For details, refer to the following link.

NOTICE

- Do not connect this product to a public Wi-Fi and/or Internet service directly. Set up an appropriate password for the router that it goes through. Do not connect directly to communication lines (including public LANs) of telecommunications carriers (mobile communication companies, fixed-line providers, Internet providers, etc.).

NOTE

- To make a wired connection, connect the LAN cable to the sound bar before turning on the sound bar. For details, refer to the following link.
- Streaming services vary with country and region where the product is used.

Related links

- “Connecting to a network using a LAN cable (wired connection)” (p.43)
- “Registering to a MusicCast network” (p.56)

Connecting to a network using a LAN cable (wired connection)

Connect the sound bar to a router using a commercially available LAN cable (a CAT-5 or higher STP straight cable). The wired connection is now complete.

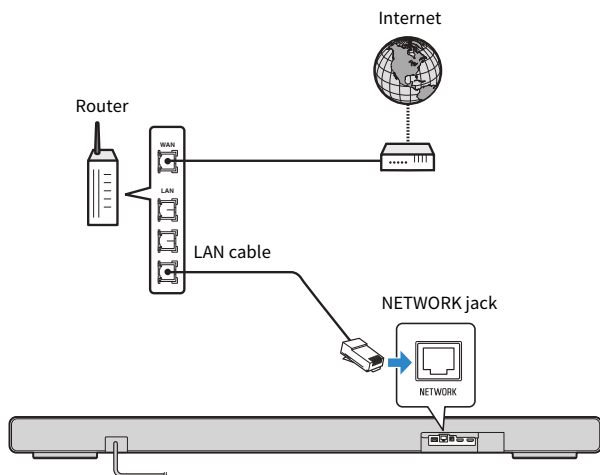

NOTICE

- To safely connect the sound bar to the Internet, be sure to connect it via a router or similar device. Set up an appropriate password for the router that it goes through. Do not connect directly to communication lines (including public LANs) of telecommunications carriers (mobile communication companies, fixed-line providers, Internet providers, etc.).
- Use STP (Shielded Twisted Pair) cable to prevent electromagnetic interference.
- If your router does not support a DHCP server or network information is manually allocated, you may have to set up the network.

Next steps

- “Connecting to power” (p.44)

Related links

- “Connecting to a network” (p.42)
- “Registering to a MusicCast network” (p.56)
- “Setting up a network” (p.127)

Connecting to power

- Before connecting devices, be sure to read the following precautions.
 - “Precautions for preparation” (p.31)

After connecting to the TV and AV devices, connect the sound bar and subwoofer to power.

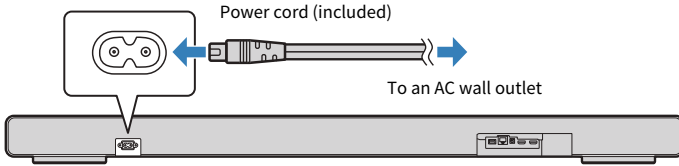

Sound bar (rear)

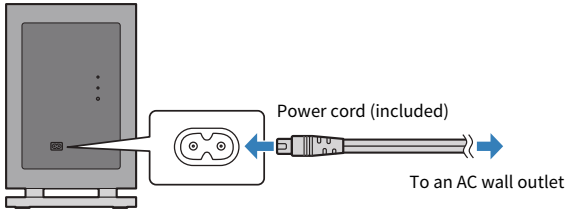

Subwoofer (rear)

Next steps

- “Turning on the sound bar” (p.45)

Turning on the sound bar

Turn the product on.

Check that the indicators on the front display of the sound bar are off and the power lamp on the rear of the subwoofer flashes green or red before turning on the sound bar.

- 1 Turn on the TV.**
- 2 Press the  (Power) key on the remote control.**

When the sound bar is turned on, it is automatically connected to the subwoofer wirelessly and the front display shows current settings.

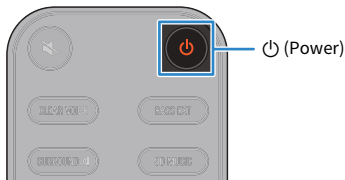

3 Select the input on the TV to sound bar.

Select sound bar on the TV input. For details, refer to the instruction manual for your TV.

If a LAN cable is not connected, a message regarding network settings will appear on the TV screen.

If this is the case, press the ↵ (Return) key to close the message.



NOTE

Pressing the ⏻ (Power) key when the power is on will turn the sound bar off. When the sound bar is turned off, the indicators go off.

Next steps

- "Confirming subwoofer connection" (p.47)

Confirming subwoofer connection

Confirm that the subwoofer is connected to the sound bar.

If the following applies, the subwoofer is connected to the sound bar.

- The  icon is shown on the front display of the sound bar



Glowing: Connected
Off: Not registered or not connected

- The CONNECT indicator on the subwoofer glows green

NOTE

If the status indicator is rapidly flashing red, a malfunction may have occurred in the subwoofer. Refer to "TROUBLESHOOTING" (p.157).

Next steps

- To turn the HDMI Control function On:
 - "Enabling the HDMI Control function" (p.48)
- To use the HDMI Control function when Off:
 - If TRUE X SURROUND will not be used or set up later:
 - "Registering to a MusicCast network" (p.56)
 - To use TRUE X SURROUND:
 - "Registering wireless speakers to the sound bar" (p.60)

Enabling the HDMI Control function

By turning On the HDMI Control function, you can use convenient functions such as linking to TV operations. To listen to audio from a TV that only supports ARC, you have to turn On the HDMI Control function. If necessary, turn the HDMI Control function On.

NOTE

The following default settings are provided.

- Models for U.K. and Europe: Off
- Models for other areas: On

HDMI Control function

Use an HDMI cable to connect the sound bar to a TV, then turn the HDMI Control function On to allow you to do the following.

- Link turning the TV on and off
- Using the TV remote control to adjust the volume of the sound bar
- Automatically switch the input to “TV”
- Use the ARC function to output TV audio from the sound bar

■ When the HDMI Control function is needed to listen to audio from a TV

To connect a TV that only supports ARC using an HDMI cable, you have to turn the HDMI Control function and ARC function to On.

When the “HDMI Control” is “On”, the “ARC” setting can be used. The default setting of “HDMI Control” is “Off” and the default setting of “ARC” is “On”.

HDMI Jack(s) of the TV you want to connect to	You can listen to TV audio also when the HDMI Control function is set to Off
eARC/ARC supported HDMI IN jack	✓
HDMI IN jack and OPTICAL jack	✓
ARC supported HDMI IN jack	-

NOTE

If you cannot output audio from the TV sound using the sound bar, refer to the TV instruction manual as well.

■ Enabling the HDMI Control function

Set “HDMI Control” to “On” from the TV Setup menu.

1 Press the ⚙️ (Setup) key.

The Setup menu appears on the TV.

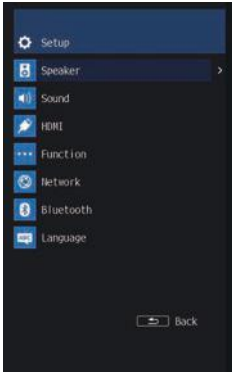

2 In "HDMI" Select "HDMI Control".

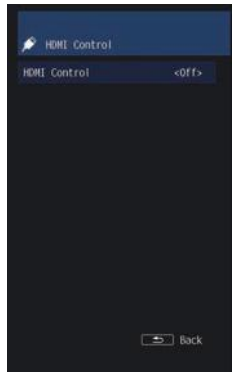
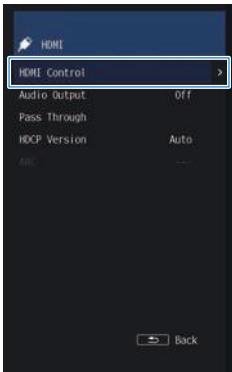

3 In the HDMI Control screen, select “On”.

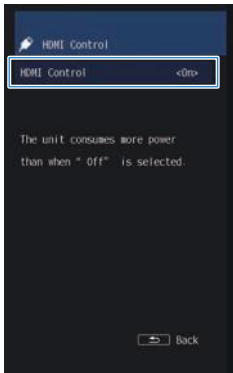

4 Press the ⚙️ (Setup) key.

The Setup menu closes.

This completes the setting.

NOTE

- Setting the HDMI Control function to On consumes more power than when it is set to Off.
- When connecting an HDMI jack that supports only ARC on the TV to the HDMI OUT/TV (eARC) jack on the sound bar, set also “ARC” to “On”. The default setting is “On”.

Related links

“Making HDMI settings” (p.121)

Next steps

- “Checking that the sound bar outputs audio” (p.51)

Checking that the sound bar outputs audio

Play back content to check that audio is actually output.

■ Checking TV audio

Watch the TV connected to the sound bar to confirm that TV audio is being output from the sound bar. If TV audio is not output, press the INPUT key on the remote control to switch the input source to “TV”.

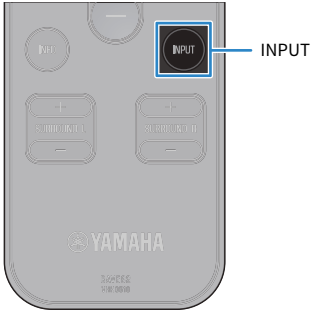

NOTE

- If audio is being output from both the TV speakers and the sound bar, mute the TV speakers.
- If you have AV devices connected to the TV, switch the input source to “TV” in the same way and check if audio is output from the sound bar.

■ Checking audio from AV devices

Play an AV device connected to the sound bar's HDMI IN jack and press the INPUT key on the remote control to switch the input source to “HDMI”.

Check that the sound bar outputs audio from the AV device.

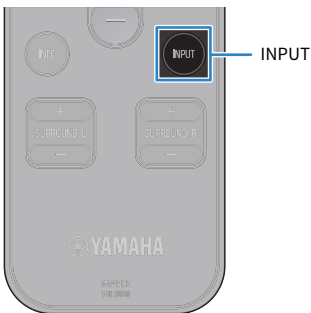

NOTE

When an AV device is connected to the HDMI IN jack of the sound bar, the HDMI cable connecting the sound bar to the TV transmits the video signal from the AV device to the TV.

Next steps

- If TRUE X SURROUND will not be used or set up later:
 - “Registering to a MusicCast network” (p.56)
- To use TRUE X SURROUND:
 - “Registering wireless speakers to the sound bar” (p.60)

Connecting wireless speakers (TRUE X SURROUND)

If you wish to connect and use TRUE X SURROUND wireless speakers such as WS-X3A with the sound bar, refer to the related link.

Refer to the “TRUE X SURROUND” section in this guide for details on how to use TRUE X SURROUND.

Related links

“Registering wireless speakers to the sound bar” (p.60)

Next steps

- “Registering to a MusicCast network” (p.56)

Setting MusicCast

MusicCast

With MusicCast, you can share music with MusicCast devices installed in multiple rooms. The MusicCast Controller smartphone application allows you to easily enjoy music from your smartphone, media server (computer/NAS), Internet radio or streaming services anywhere in your home.

Refer to the Yamaha website for more information on MusicCast and compatible devices.

Related links

- “MusicCast Controller” (p.55)
- “Registering to a MusicCast network” (p.56)

MusicCast Controller

Use of network functions on a MusicCast compatible device requires the use of the “MusicCast Controller” smartphone application. Search for “MusicCast Controller” (free) on the App Store or Google Play and install it.

Registering to a MusicCast network

Connect the sound bar to the MusicCast network. At the same time, connect the sound bar to a wireless network.

To become a registered user of the MusicCast network requires the “MusicCast Controller” smartphone application. Search for “MusicCast Controller” (free) on the App Store or Google Play and install it.

Confirm that your smartphone is connected to your home router before operation.

1 Start up the “MusicCast Controller” on your smartphone and tap “Setup”.



If you have another already registered MusicCast device, tap the “Settings” tab and tap “Add New Device”.

2 Follow the instructions in the “MusicCast Controller” and hold down the INPUT/CONNECT button on the sound bar for 5 seconds or longer.

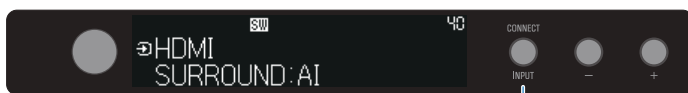

INPUT (CONNECT)

The  (wireless LAN) icon starts to flash when entering the registration mode.

3 Connect and set up the MusicCast network according to the “MusicCast Controller” instructions.

This completes your MusicCast network registration.

NOTE

- The sound bar cannot be connected to a wireless LAN router (an access point) if they are far apart. In such a case, install the sound bar and wireless LAN router (access point) close to each other.
- To make a wireless connection to the network, get a wireless LAN router SSID (access point) and set a security key.
- MusicCast Controller screens and menu names are subject to change without notice.

Related links

“MusicCast Controller” (p.55)

TRUE X SURROUND

What is TRUE X SURROUND?

TRUE X SURROUND is a function to easily obtain real surround sound through use of TRUE X SURROUND compatible wireless speakers such as TRUE X SPEAKER 3A (WS-X3A) as surround speakers for the sound bar.

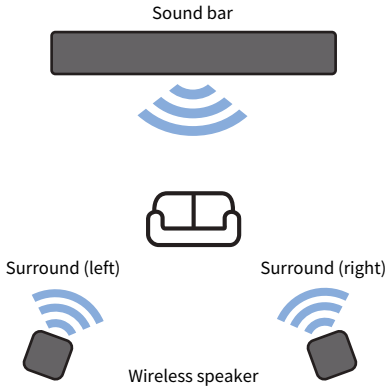

The sound bar and wireless speakers are connected wirelessly for communication between them. For that reason, when using these products for the first time, the respective device information of the sound bar and wireless speakers needs to be registered to one another.

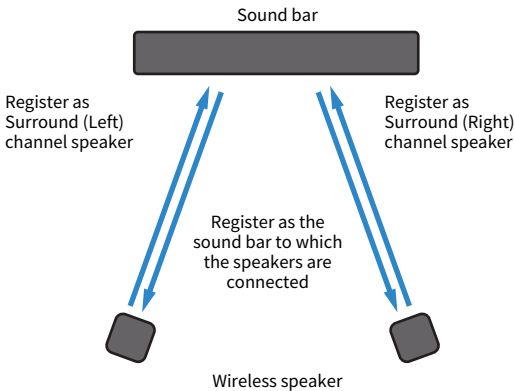

In addition to the real surround sound, you can use the "ALL mode" to output music from both the sound bar and the wireless speakers to enjoy music and video in a wider setting.

There is also a "SOLO mode" that allows you to use the wireless speakers independently of the sound bar as Bluetooth speakers in a different room.

Video overview of TRUE X SURROUND (YouTube)

Overview of TRUE X SURROUND (YouTube)

NOTE

It is also possible to use only one wireless speaker. If only one wireless speaker is registered, the connected wireless speaker outputs Surround (Left) sound and Surround (Right) sound.

Related links

- “Registering wireless speakers to the sound bar” (p.60)
- “Surround playback” (p.74)
- “Switching between the modes (SOLO/SURROUND) of the wireless speakers” (p.80)

TRUE X SURROUND instructions list

A list of instructions for TRUE X SURROUND.

■ **What is TRUE X SURROUND? (p.57)**

This section explains TRUE X SURROUND.

■ **Preparations to use TRUE X SURROUND for the first time**

Information on TRUE X SURROUND for first time users.

- Registering wireless speakers to the sound bar (p.60)
- Installing wireless speakers (p.69)
- Checking whether the wireless speakers output sound (p.71)

■ **Playback operations**

Instructions for how to play back audio using TRUE X SURROUND speakers.

- Using surround speakers for playback (p.74)
- Adjusting volume balance (p.77)
- Playing the same audio from all speakers (ALL mode) (p.78)
- Switching between wireless speaker modes (SOLO/SURROUND) (p.80)

■ **Changing the connection settings**

The following information describes how to modify the wireless speakers and how to deregister them.

- Deregistering wireless speakers from the sound bar (p.81)

■ **Checking the connection status (p.82)**

Instructions for how to check the connection status of the wireless speakers and the sound bar.

■ **Frequently asked questions (p.173)**

Frequently asked questions about TRUE X SURROUND.

Preparations to use TRUE X SURROUND for the first time

Registering wireless speakers to the sound bar

To connect TRUE X SURROUND wireless speakers to the sound bar for the first time, follow the order of the procedure described below to register the wireless speakers you connect to the sound bar. Registration is required for initial connection only.

If registering only one wireless speaker

- It is also possible to register and use only one wireless speaker. In this case, you do not need to register the second wireless speaker. When the registration of one wireless speaker is complete, proceed to set it up.

How-to video

You can also watch a video about the registration procedure.

[Initial setup for TRUE X SURROUND \(YouTube\)](#)

■ Preparation for registration

1 Turn on the wireless speakers and sound bar.

Place the wireless speakers near the sound bar during registration to avoid interference from other nearby wireless devices and help the registration complete successfully.

To turn on the wireless speakers, hold down the power button of the wireless speakers for 2 seconds.

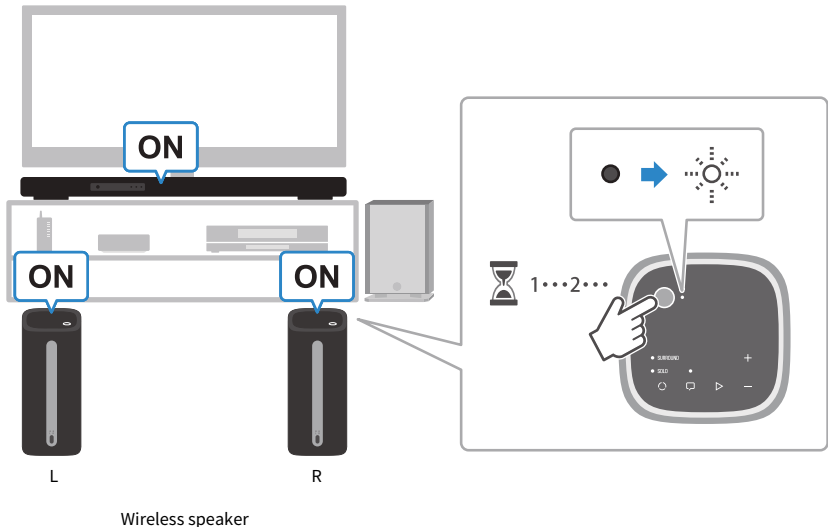

■ Registering the first wireless speaker

Register the wireless speaker (L) as Surround Speaker (Left).

If you want to register only one wireless speaker, perform the following procedure.

NOTE

The wireless speakers do not have a right or left side. It does not matter which of the two speakers you register first.

1 Hold down (mode) for at least three seconds on the wireless speaker.

A notification tone will be heard making it possible to select the Left (L) or Right (R) speaker.

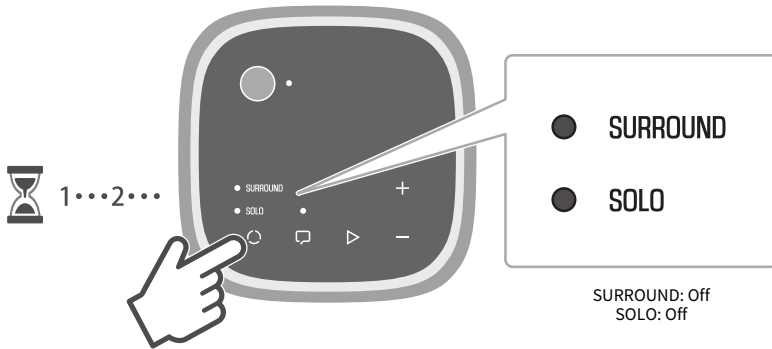

2 Press (mode) to turn on the L indicator.

Each press of the button switches between L and R. The default setting is "L" (Surround (Left)).

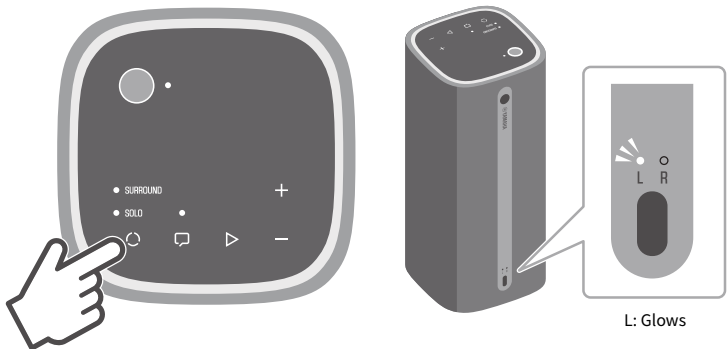

3 Hold down  (mode) for at least three seconds on the wireless speaker.

The notification tone indicates that the wireless speakers have entered the registration wait status, and the SURROUND indicator on the wireless speaker will start to flash.

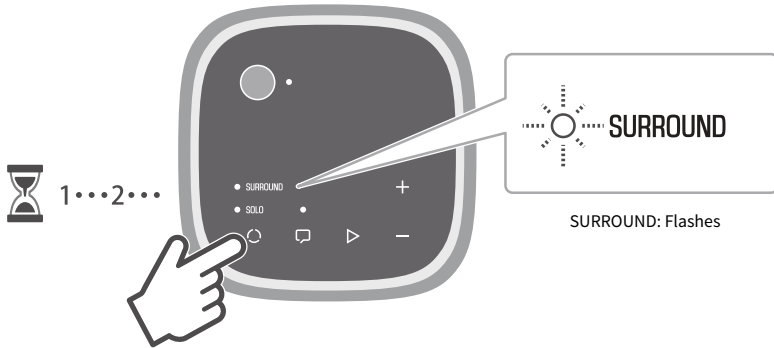

In the next step, operate the controls of the sound bar. Operate the controls of the sound bar within two minutes after the wireless speaker has entered the registration wait status.

The wait status is canceled after two minutes have elapsed. If this happens, start over from step 1.

4 Press the  (Setup) key on the remote control of the sound bar to open the Setup menu.

5 In the Setup menu, under “Speaker” > “Registration”, select “Registration”.

The “Registration” screen appears.

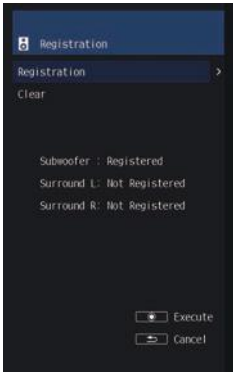

Follow the instructions on the screen to register wireless speakers to the sound bar.

When the SURROUND indicator on the control panel of the wireless speaker changes from flashing to glowing and “Registered” appears in the “Registration” screen, the registration is complete. The wireless speaker is registered as Surround Speaker (Left).

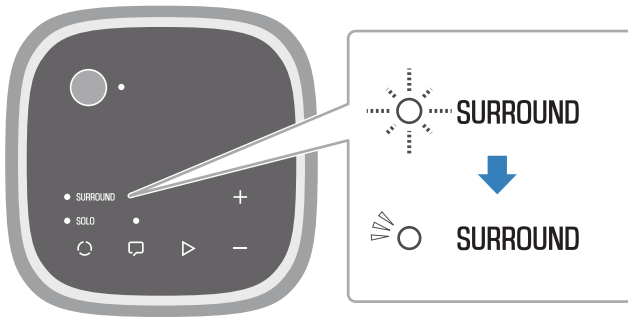

If you only want to connect one wireless speaker, the registration procedure is complete. Proceed to install the wireless speaker.

If you want to connect two surround speakers, use the procedure below to register the second surround speaker.

NOTE

- If only one wireless speaker is registered, both the L and R indicators on the rear of the wireless speaker are glowing.

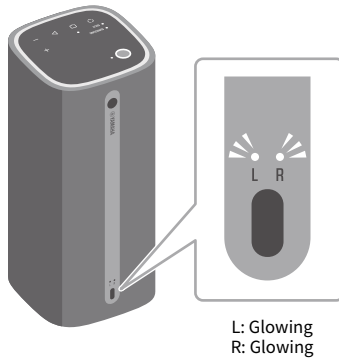

- If the registration is not complete within two minutes after the wireless speaker has entered the registration wait status, the registration wait status will be canceled.
- To interrupt the registration procedure, hold down the power button for at least three seconds to turn off the wireless speaker.
- If there is a firmware update after completing the registration, the update will start automatically.
- If you update sound bar firmware manually after registration, you may also have to update the firmware of the wireless speakers. The wireless speaker firmware will be updated automatically and “Wireless SP : FW Updating..” will appear on the front display. When “Update success” appears on the front display, turn off the sound bar and then turn it back on. Depending on the number of connected wireless speakers, you may have to repeat the firmware update process several times.
- If the Wireless Speakers are connected to a power source, turning on the sound bar will automatically turn on the Wireless Speakers.
- When the True X Ready function is set to “On”, the wireless speakers turn on with the sound bar earlier than when the function is set to “Off”.

■ Registering the second wireless speaker

Perform the same operation as the first wireless speaker (L) to register the second wireless speaker (R) as Surround Speaker (Right).

1 Hold down  (mode) for at least three seconds on the wireless speaker.

A notification tone will be heard making it possible to distinguish Left (L) and Right (R) speakers.

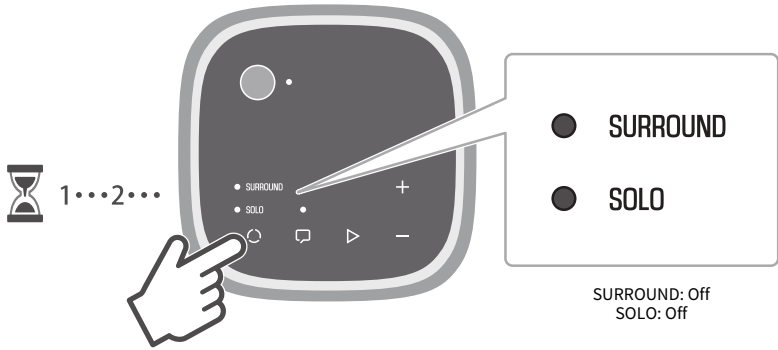

2 Press  (mode) to turn on the R indicator.

Each press of the button switches the indication between L and R and the notification tone is heard. The default setting is “L” (Surround (Left)).

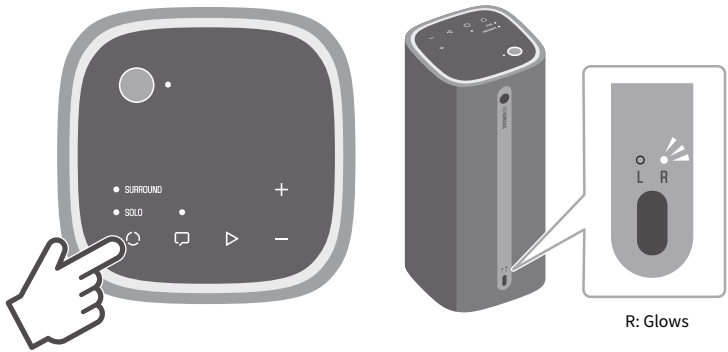

3 Hold down  (mode) for at least three seconds on the wireless speaker.

The notification tone indicates that the wireless speakers have entered the registration wait status, and the SURROUND indicator on the wireless speaker will start to flash.

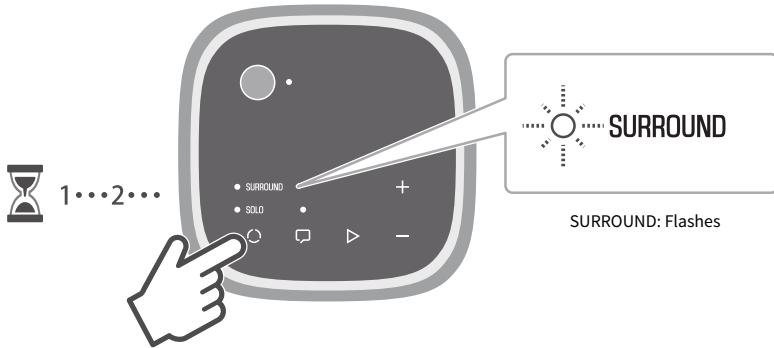

In the next step, operate the controls of the sound bar. Operate the controls of the sound bar within two minutes after the wireless speaker has entered the registration wait status.

The wait status is canceled after two minutes have elapsed. If this happens, start over from step 1.

4 Press the  (Setup) key on the remote control of the sound bar to open the Setup menu.

5 In the Setup menu, under “Speaker” > “Registration”, select “Registration”.

The “Registration” screen appears.

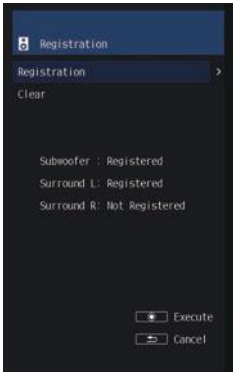

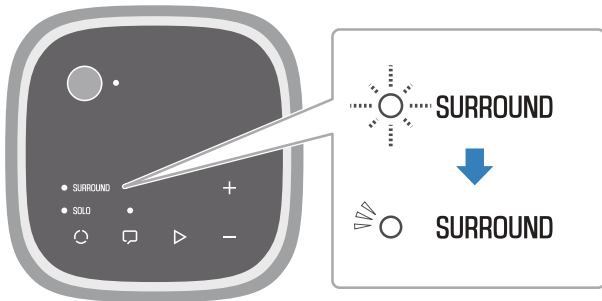

Follow the instructions on the screen to register wireless speakers to the sound bar.

When the SURROUND indicator on the control panel of the wireless speaker changes from flashing to glowing and “Registered” appears in the “Registration” screen, the registration is complete. The wireless speaker is registered as Surround Speaker (Right).



The L or R indicator on the rear of each wireless speaker glows according to the channel it is registered as.

Check the following if the registration status of a speaker shows “Not registered” on the “Registration” screen.

- The same channel (L/R) registered for the first wireless speaker is also selected for the second wireless speaker.
 - Hold down  (mode) for at least three seconds to select a different channel, and then hold down  (mode) for at least three seconds again.
- The wireless speaker's registration wait status is expired.
 - The registration wait status will be canceled after more than two minutes have elapsed. Start over the registration procedure again.

6 Press the  (Setup) key on the remote control of the sound bar to open the Setup menu.

7 In the Setup menu, under “Power Management” > “True X Ready”, select “On”.



Proceed to install the wireless speakers in their respective positions.

NOTE

- If the registration is not complete within two minutes after the wireless speaker has entered the registration wait status, the registration wait status will be canceled.
- To interrupt the registration procedure, hold down the power button for at least three seconds to turn off the wireless speaker.
- If there is a firmware update after completing the registration, the update will start automatically.
- If you update sound bar firmware manually after registration, you may also have to update the firmware of the wireless speakers. The wireless speaker firmware will be updated automatically and “Wireless SP : FW Updating..” will appear on the front display. When “Update success” appears on the front display, turn off the sound bar and then turn it back on. Depending on the number of connected wireless speakers, you may have to repeat the firmware update process several times.
- If the Wireless Speakers are connected to a power source, turning on the sound bar will automatically turn on the Wireless Speakers.
- When the True X Ready function is set to “On”, the wireless speakers turn on with the sound bar earlier than when the function is set to “Off”.
- Setting the “True X Ready” to “On” consumes more power than when it is set to “Off”.

Related links

- “Installing wireless speakers” (p.69)
- “Checking whether audio is output from the wireless speakers” (p.71)
- “Checking the connection status of the wireless speakers on the sound bar” (p.82)
- “Setting up detailed function settings (Function)” (p.124)

Installing wireless speakers

When the registration is complete, proceed to install the wireless speakers in their respective positions. Check the status of the L/R indicators on the rear of the wireless speakers, and install the wireless speakers accordingly.

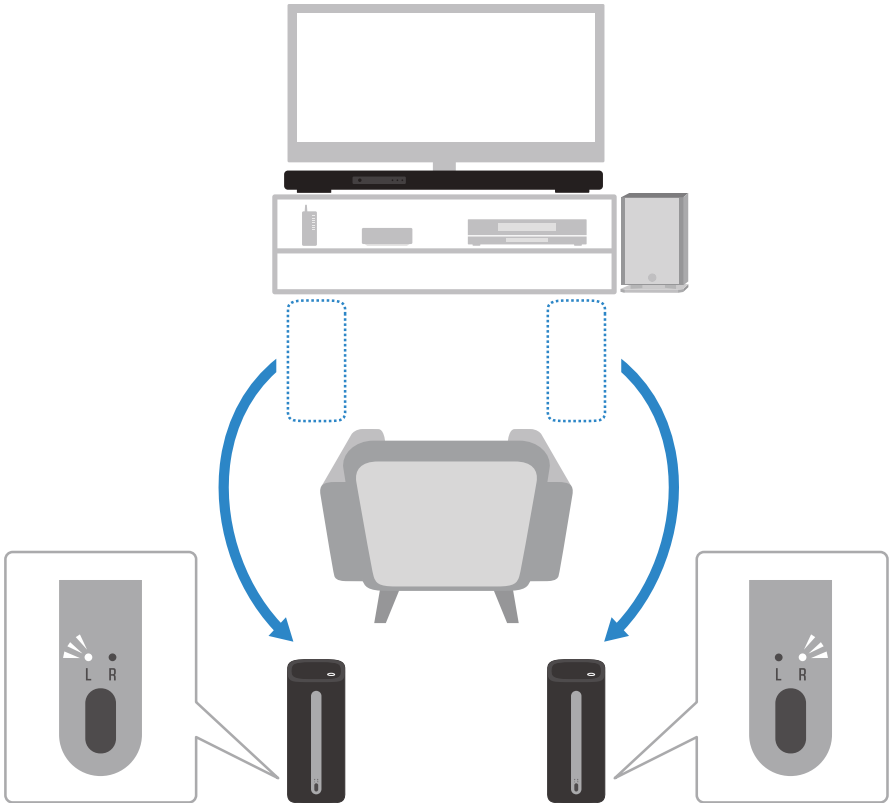

If only one wireless speaker is registered, perform the following procedure to install it.

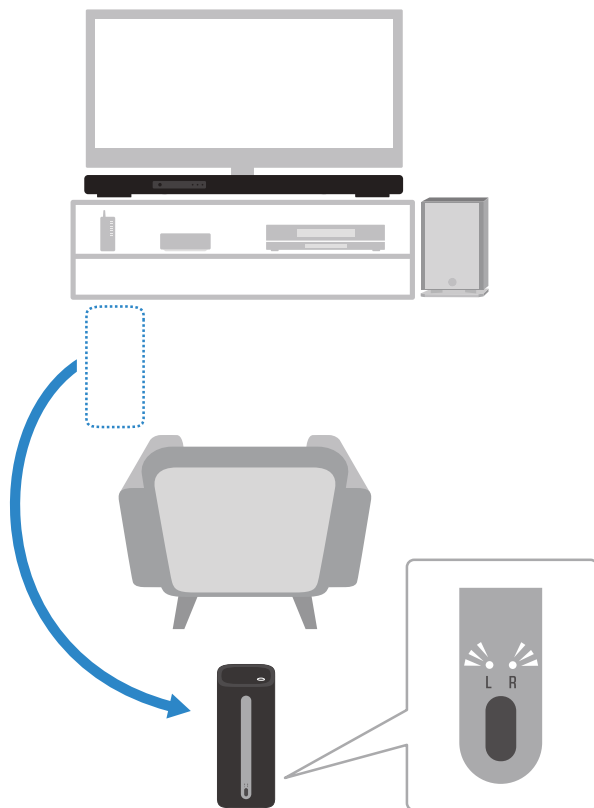

The connection and installation procedures are completed. The product is now ready for playback. Next, check the connection status of the wireless speakers.

Related links

- “Checking whether audio is output from the wireless speakers” (p.71)
- “Registering wireless speakers to the sound bar” (p.60)

Checking whether audio is output from the wireless speakers

When the connection is established, play content to check that audio is actually output from the connected wireless speakers.

1 Play content on the sound bar.

Check that audio is being output from the sound bar.

2 Point the sound bar remote control at the sound bar and press the ALL key to switch to ALL mode.

ALL mode is a mode that outputs the same music from the sound bar and the wireless speakers. In this state, check that audio is being output from the wireless speakers.

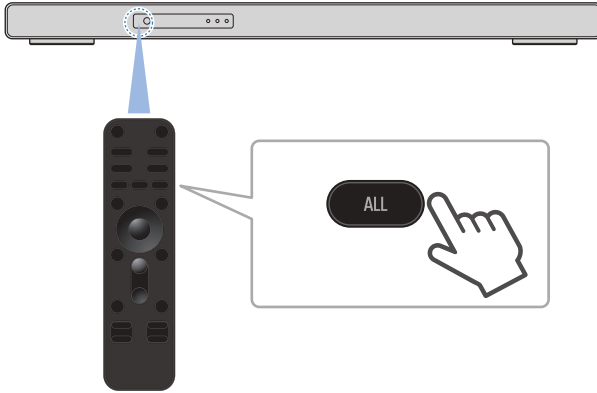

If no audio is being output from the wireless speakers, check for the following.

- The SOLO indicators of the wireless speakers are glowing or flashing.
 - Press  (mode) to switch to SURROUND.

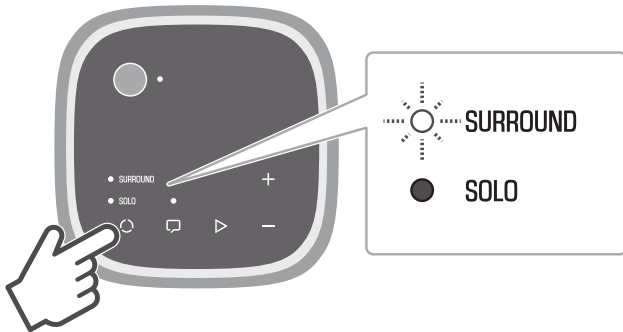

- The SURROUND indicators on the wireless speakers are flashing rapidly.
 - The wireless speakers are waiting to be registered to the sound bar. Reregister the wireless speakers.

- 3 Once you have checked that audio is output from the wireless speakers, point the sound bar remote control at the sound bar and press the SURROUND:AI, 3D MUSIC, or STRAIGHT key to switch to surround playback.**

Enjoy surround sound playback.

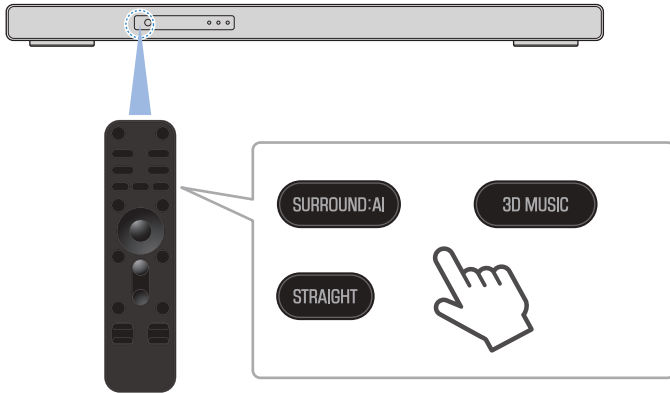

NOTE

- You can check the connection status of the wireless speakers on the front display. For details, refer to the following link.
- To check the connection status by outputting audio from each speaker in turn, select “Test Tone” under “Speaker” > “Level” in the Setup menu. For details, refer to the following link.

Related links

- “Registering wireless speakers to the sound bar” (p.60)
- “Checking the connection status of the wireless speakers on the sound bar” (p.82)
- “Configuring the speakers” (p.115)

Playback operations

Surround playback

This section describes the basic control operations for surround playback on the sound bar and wireless speakers.

1 Turn on the sound bar.

If the wireless speakers connected to the sound bar are connected to power, they will be turned on. In this case, proceed to step 3.

2 If the wireless speakers are not turned on, hold down their power buttons to turn them on.

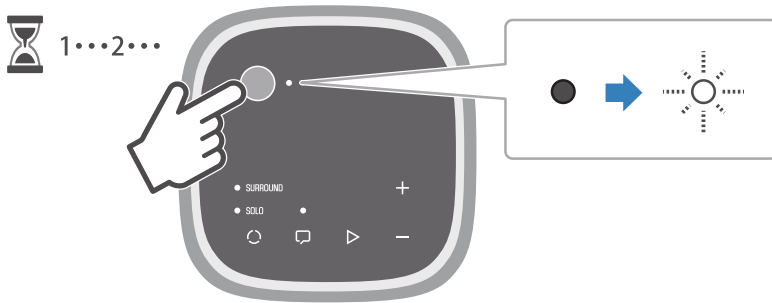

Note

- If “Wireless SP : FW Updating..” appears on the front display of the sound bar after the registration is complete, the firmware is being updated. Turning off the wireless speakers while the firmware is being updated may cause malfunction. Wait until the power indicator stops flashing.

3 If the **SOLO** indicators of the wireless speakers are flashing or glowing, press  **(mode)** to select **SURROUND**.

The **SURROUND** indicator starts flashing. When the connection with the sound bar is established, the **SURROUND** indicator stops flashing and starts glowing.

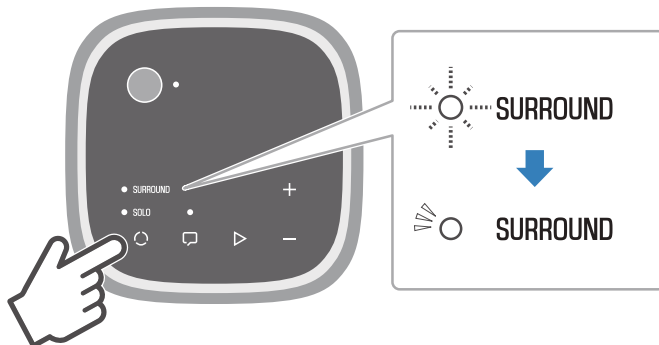

- 4 Check whether the L or R indicator on the rear of each wireless speaker is glowing, and install the wireless speakers in their respective positions.**

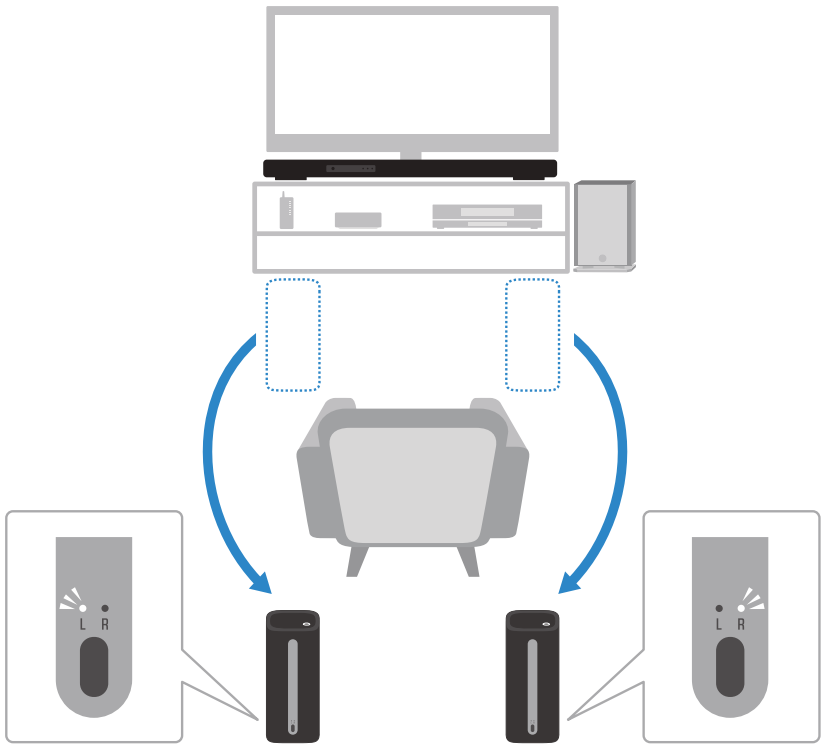

- 5 Start surround playback on the sound bar.**

- 6 To stop using the sound bar, turn it off.**

This will turn off the wireless speakers connected to the sound bar at the same time.

Adjusting the volume balance

Adjusting the volume of the sound bar during playback using TRUE X SURROUND will adjust the volume of the sound bar and the wireless speakers.

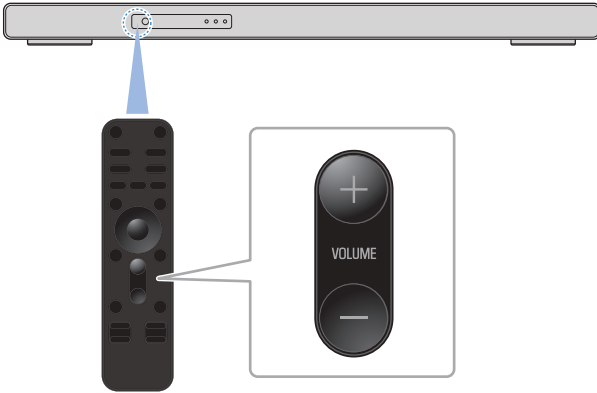

The volumes of the wireless speakers (surround channels) can also be adjusted individually. After the overall volume of the sound bar and wireless speakers has been adjusted, the volumes of the wireless speakers can be adjusted to achieve the optimal balance.

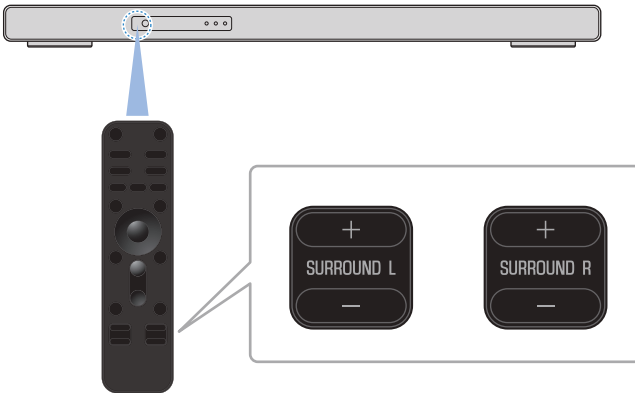

Playing the same audio from all speakers (ALL mode)

When the mode is switched to the ALL mode, the wireless speakers (surround speakers) connected to the sound bar will output same audio as the sound bar in monaural mode. This mode is useful for making audio easy to hear from anywhere in a large room.

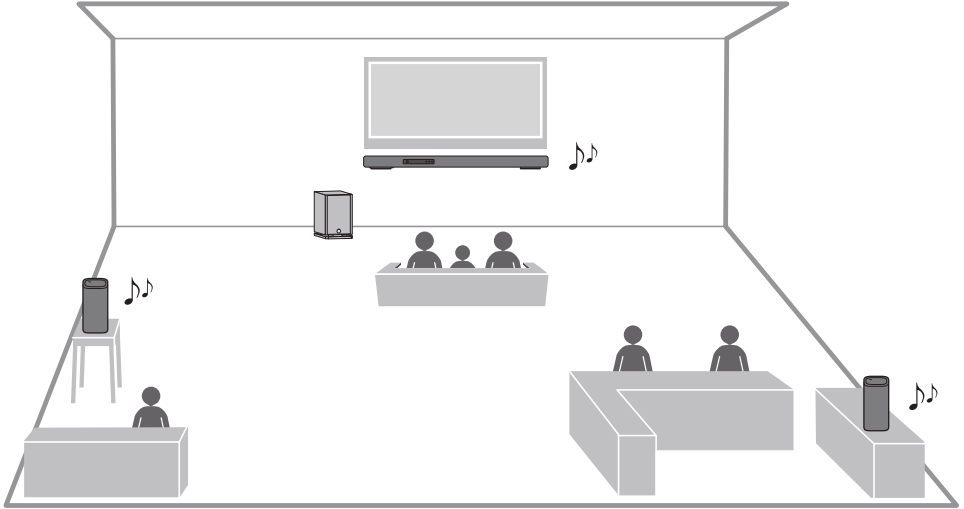

Point the sound bar remote control at the sound bar and press the ALL key to switch to ALL mode.

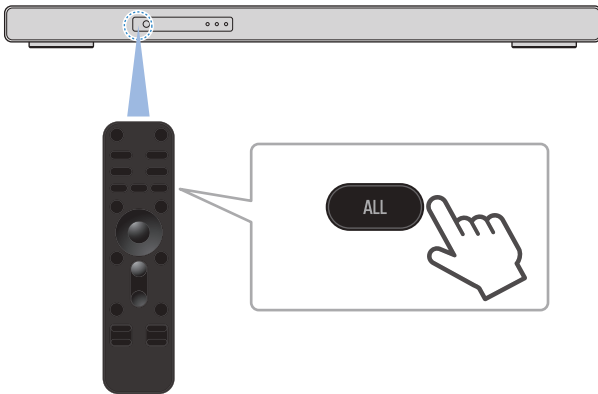

A short message displays “ALL” when you switch to ALL mode.

When the INFO key is pressed to open the sound mode during playback in ALL mode, “ALL” is displayed on the front display.

To cancel ALL mode, press one of the following keys on the remote control to switch to surround playback or stereo playback: SURROUND:AI, 3D MUSIC, STRAIGHT, or STEREO.

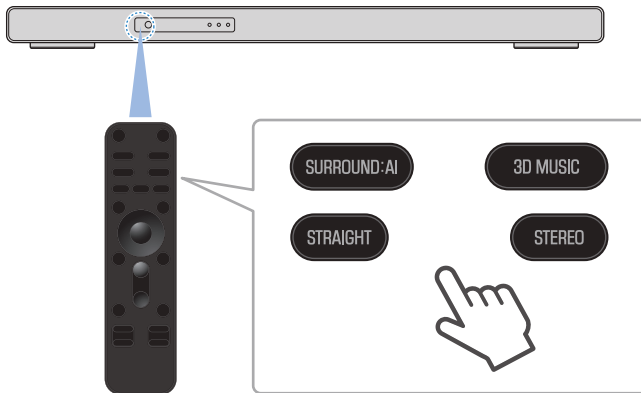

NOTE

- In ALL mode, multi-channel playback is off, and the sound bar provides stereo playback while the wireless speakers provide monoaural playback.
- Install wireless speakers within 10 m (33 ft) of the sound bar.
- If there is a wall or other obstacle between the sound bar and wireless speakers, the audio may cut out.

Switching between the modes (SOLO/SURROUND) of the wireless speakers

Pressing  (mode) on the wireless speakers switches modes between “SURROUND mode” for using the wireless speakers as surround speakers for the sound bar and “SOLO mode” for using the wireless speakers as Bluetooth speakers.

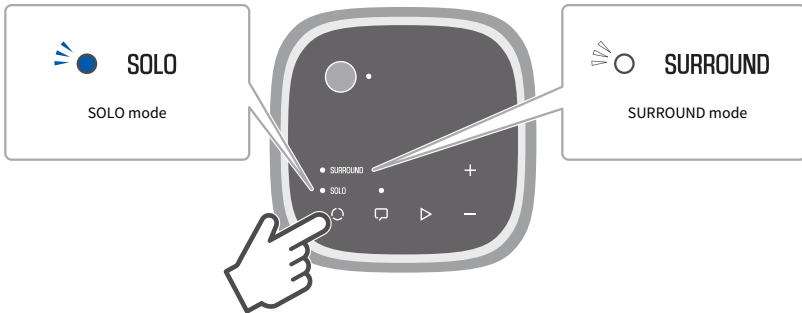
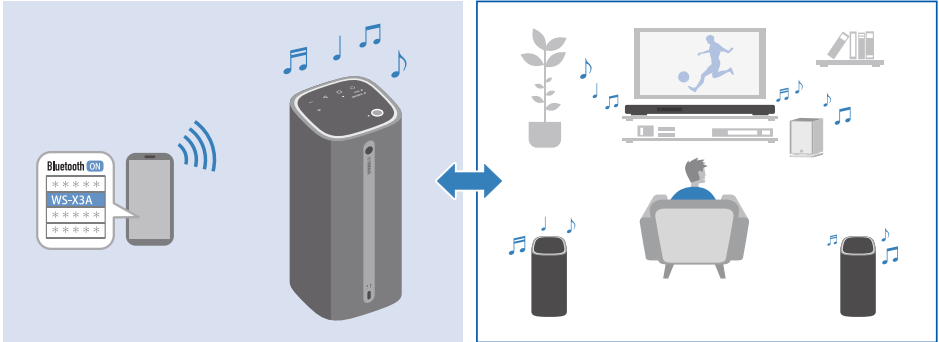

For details on operating in SOLO mode, refer to the wireless speaker User Guide.

Removing the registration of wireless speakers to the sound bar

Delete the registration information stored in the sound bar and disconnect the TRUE X SURROUND wireless speakers completely.

1 Press the  (Setup) key on the remote control of the sound bar to open the Setup menu.

2 In the Setup menu, under “Speaker” > “Registration”, select “Clear”.

This removes the registration of the wireless speakers and the subwoofer.

NOTE

- This procedure removes all speaker registrations from the sound bar. Since the subwoofer registration is also removed, follow the instructions for manually registering a subwoofer if you need to register a subwoofer again. For details, refer to the following link.
- To connect deregistered wireless speakers to the sound bar again, follow the procedure for connecting a new wireless speakers to the sound bar. For details, refer to the following link.
- If you want to change the number of connected wireless speakers from two to one, you need to delete the registration information stored in the sound bar. Then register the wireless speaker that you want to connect to the sound bar again.
- If you want to change the number of connected wireless speakers, you need to delete the registration information stored in the sound bar. Then register the new wireless speaker that you want to connect to the sound bar again.

Related links

- [“Configuring the speakers” \(p.115\)](#)
- [“Registering wireless speakers to the sound bar” \(p.60\)](#)
- [“Connecting a subwoofer manually” \(p.198\)](#)

Checking the connection status

Checking the connection status of the wireless speakers on the sound bar

The front display of the sound bar allows you to check wireless speaker connection status of the wireless speakers.



1 Connection of Surround Speaker (Left)

Glowing: Connected

Off: Not registered or not connected

2 Connection of Surround Speaker (Right)

Glowing: Connected

Off: Not registered or not connected

NOTE

- If only one wireless speaker is registered,  (Surround) on the front display glows when it is connected. It does not glow when not registered.
- For details on other icons, refer to the following link.

Related links

“Names of parts and functions on the front display” (p.15)

PLAYBACK

Basic control

Basic control during playback

This section describes the basic control operations available during playback.

■ Selecting an input

Press the INPUT key to change the input source.

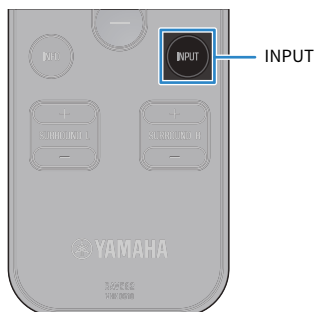

Displays the names of input sources on the front display as shown below. The TV screen also displays a short message.

- HDMI: Audio from a device connected to the HDMI IN jack
- OPTICAL: Audio from a device connected to the OPTICAL jack
- TV: Audio from TV connected to HDMI OUT/TV (eARC) jack or OPTICAL jack
- Network Input name (example: SERVER/NET RADIO, etc.): Audio from streaming services, etc.
- Bluetooth: Audio from a Bluetooth device

NOTE

- “TV” operates as follows.
 - When using the eARC function, audio is played back via eARC.
 - When the ARC function is used, audio is played back via ARC. In this situation, set “HDMI Control” to “On”, and “ARC” to “On” in the Setup menu.
 - If eARC/ARC are not used, audio from devices (TV) connected to the OPTICAL jack is output.
- You can use the smartphone application MusicCast Controller to select network input (SERVER/NET RADIO, etc.).
- If you press the INPUT key to switch to network input, the last selected input is selected. Use the MusicCast Controller to make any changes to network input.

■ Adjusting volume

Use the VOLUME +/- keys to adjust the volume.





While muted, the front display will show the following when the volume is adjusted. The volume is also displayed on the TV screen.

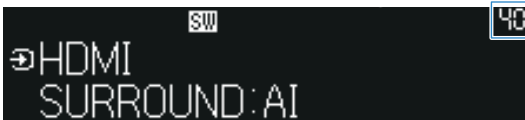

The sound volume is usually displayed at top right corner of the front display.



If audio is being output from both the TV speakers and the sound bar, mute the TV.

To temporarily mute the sound bar, press  (Mute) key on the remote control. To unmute, press  the (Mute) key again or press the VOLUME +/- keys.

Related links

“Enabling the HDMI Control function” (p.48)

Playback Screen

The Playback screen appears on the TV when playback starts.

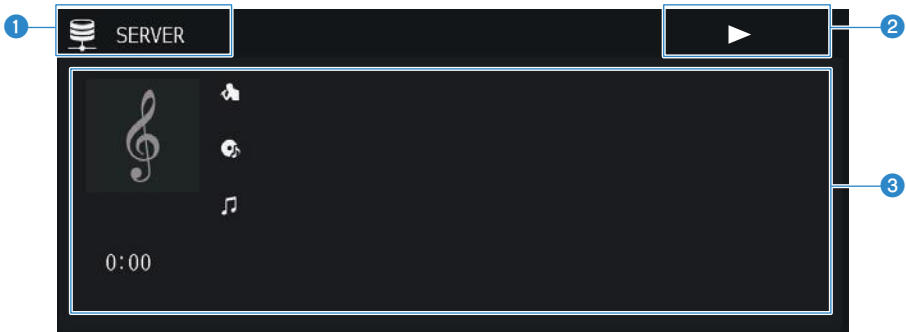

1 Input information

Information on the input source appears.

2 Playback status display

Shows Shuffle playback, repeat playback, playback status (playback/pause, etc.).

3 Playback information

Displays artist name, name of track, album name, playback track, playback time, broadcasting station, etc.

NOTE

- The above image shows playback from a media server (computer or NAS). Displayed information varies with input.
- An AirPlay, Spotify and MusicCast Link does not show playback status.

Listening to TV audio

Listening to TV audio using eARC/ARC

Connect an eARC/ARC TV to the sound bar using an HDMI cable (commercially available) to listen to TV audio on the sound bar.

When the HDMI Control function is On, the soundbar will automatically start up when the TV is turned on.

NOTE

- When using eARC when the HDMI Control function is Off, the sound bar input will not automatically switch even if you use the TV remote control to select a program. Manually switch the input to “TV”.
- When using ARC, the HDMI Control function and the ARC function must be turned On.
- These connections may require additional settings on the TV. For details, see the instruction manual supplied with your TV.
- If your TV is not an eARC/ARC TV or if you experience audio interruption when using eARC/ARC, use an optical digital cable to connect the sound bar to the TV.

Related links

- “HDMI Connection to a TV” (p.37)
- “Making HDMI settings” (p.121)

Using a digital optical audio cable to listen to TV audio on the sound bar

To listen to TV audio on the sound bar, connect the TV to the sound bar using a digital optical audio cable (commercially available).

- A TV not supporting eARC/ARC
- Not using eARC/ARC

1 In the Setup menu > “HDMI”, set “ARC” to “Off”.

2 Use the remote control to select the content (the program) you want to watch on TV.

Sound bar input will automatically switch to “TV” and the TV sound will be output from the sound bar.

NOTE

- Even if the HDMI input jack on the TV does not support eARC/ARC, the HDMI Control function can be used by connecting the sound bar to the TV with an HDMI cable.
- Even if the HDMI Control function is Off, you can press the INPUT key to switch to “OPTICAL” before using the TV remote control.

Related links

“Making HDMI settings” (p.121)

Starting playback on a Bluetooth® device

Playing back audio from a Bluetooth® device

Audio content from a Bluetooth device (smartphone, etc.) can be played back on the sound bar.



CAUTION

- If the volume is adjusted on a Bluetooth device, the volume may become unexpectedly loud, causing hearing impairment or damage to the device. If the volume becomes too loud during playback, stop playback immediately.



Sound bar



Bluetooth device (smartphone, etc.)

- 1 Press the INPUT key to switch to “Bluetooth”.**
- 2 Select sound bar (name of sound bar network) on the Bluetooth device to pair the devices.**
If a passkey is required, enter the number “0000”.
- 3 Play a track from a Bluetooth device.**
The playback screen appears on the TV.

PLAYBACK > Starting playback on a Bluetooth® device

NOTE

- Use a Bluetooth device that supports the A2DP profile. Note that not all Bluetooth devices are supported.
- Please note that Bluetooth connectivity and the functions and performance described in this guide are not guaranteed for all Bluetooth devices.
- If a paired Bluetooth device is detected, switching the input to “Bluetooth” will automatically connect to that device. To pair with a new Bluetooth device, disconnect the currently paired device and start anew.
- During playback, the volume of the sound bar can be adjusted from the Bluetooth device.
- Perform any of the following operations to terminate the connection with the Bluetooth device.
 - Terminate the connection on the Bluetooth device.
 - Set the input source on the sound bar to something other than “Bluetooth”.
 - In the Setup menu, under “Bluetooth” > “Audio Receive”, select “Disconnect” and press the ENTER key.
- When Bluetooth devices are connected, the  (Bluetooth) icon on the front display glows.



Bluetooth icon

Playback is possible using Bluetooth® wireless speakers to listen to audio on the sound bar

Bluetooth-compatible speakers/wireless headphones can be used to listen to audio played on the sound bar. Be sure to connect Bluetooth speakers/headphones device that allow you to adjust the volume. The volume cannot be adjusted on the sound bar.

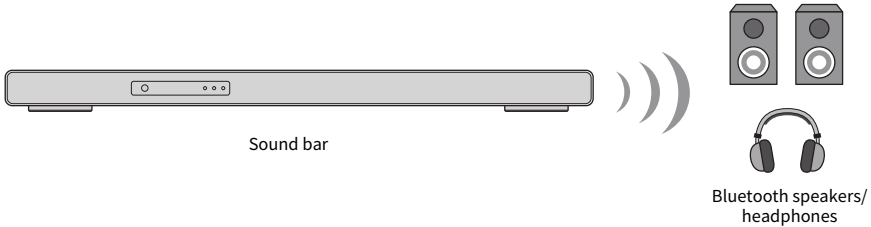

- 1 Press the INPUT key to select an input source other than “Bluetooth”.**
- 2 Press the  (Setup) key.**
- 3 In the Setup menu, under “Bluetooth” > “Audio Send”, set “Transmitter” to “On”.**
- 4 In the Setup menu, under “Bluetooth” > “Audio Send” > “Device Search”, select the Bluetooth speakers or headphones.**

When the connection is completed, “Completed” will be displayed and audio will be output from the Bluetooth speaker/headphone.

PLAYBACK > Starting playback on a Bluetooth® device

NOTE

- Use a Bluetooth device that supports the A2DP profile. Note that not all Bluetooth devices are supported.
- Please note that Bluetooth connectivity and the functions and performance described in this guide are not guaranteed for all Bluetooth devices.
- Adjust the volume on the connected Bluetooth device.
- Audio being played with AirPlay cannot be transmitted.
- The “Audio Send” and “Audio Receive” Bluetooth functions cannot be used simultaneously.
- If the Bluetooth device you wish to connect does not appear in the list, pair the Bluetooth device and then perform the “Device Search” again.
- Perform any of the following operations to terminate the connection with the Bluetooth device.
 - Terminate the connection on the Bluetooth device.
 - In the Setup menu, under “Bluetooth” > “Audio Send”, set “Transmitter” to “Off”.
- When Bluetooth devices are connected, the  (Bluetooth) icon on the front display glows.



Bluetooth icon

Play back using MusicCast Controller (app)

Playing streaming services

You can listen to content distributed by various streaming services on the Internet on the sound bar.

Use the applications provided by the streaming service or use the MusicCast Controller to select streaming service and content.

See the product information page on the Yamaha website regarding which streaming services the product currently supports or information provided by MusicCast Controller.

Additional information about each streaming service is also provided on the following website:

<https://manual.yamaha.com/av/mc/ss/>

NOTE

- Some streaming services may require you to purchase a paid subscription to listen to their content on the sound bar. For more information, visit their websites to check.
- Streaming services may change or be discontinued without notice. Please note that Yamaha Corporation does not accept any responsibility and will not be liable for any streaming service.

Playing back audio files

You can use the MusicCast Controller installed on a smartphone to play back music on a smartphone or media server (computer or NAS) via the network. Follow the instructions on the screen of the MusicCast Controller smartphone app.

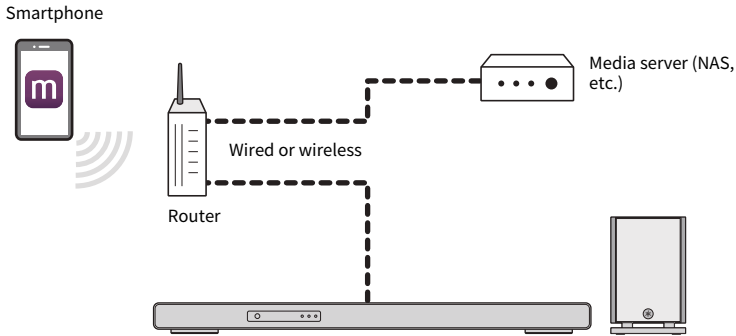

NOTE

- The media sharing setting on each device or media server software must be enabled. See the documentation supplied with each device or software for more information.
- DRM (copyright-protected content) cannot be played.
- The smartphone, media server and sound bar must be connected to the same network.
- The playable formats differ depending on the server software installed on the media server (computer or NAS). See the documentation supplied with the server software for more information.

Internet Radio Playback

Use the MusicCast Controller application installed on a smartphone to playback Internet radio. Follow the instructions on the screen of the MusicCast Controller smartphone app.

NOTE

- This function uses the airable.Radio service. airable is a service provided by airable GmbH.
- This service may be changed, stopped, or terminated without notice. Please note that Yamaha Corporation does not accept any responsibility and will not be liable for any streaming service.
- Reception may not be possible for some Internet radio stations or at certain times of the day.

Using AirPlay to playback music

You can use AirPlay to play back audio content on the sound bar. Tap (or click) the AirPlay icon on your iPhone or iTunes/Apple Music app and select the sound bar as the output destination.



CAUTION

- If the volume is adjusted on an AirPlay device, the volume may become unexpectedly loud, causing hearing impairment or damage to the device. If the volume becomes too loud during playback, stop playback immediately.

NOTE

- Starting playback on an AirPlay device will automatically turn on the sound bar.
- The names of networks displayed on an AirPlay device can be changed.
- During playback, the volume of the sound bar can be adjusted from the AirPlay device.
- The sound bar supports AirPlay 2.
- For details about AirPlay, visit the Apple website.

Related links

- “Set the volume linking the AirPlay playback device and the sound bar” (p.110)
- “Setting up detailed function settings (Function)” (p.124)
- “Setting up a network” (p.127)

ADJUSTING THE SOUND TO YOUR PREFERENCE

Selecting music of your choice (Sound mode)

The sound bar is equipped with sound modes for surround playback and for stereo playback. There are also various sound settings for adjusting the sound to better suit your preferences.

NOTE

The default is "SURROUND:AI".

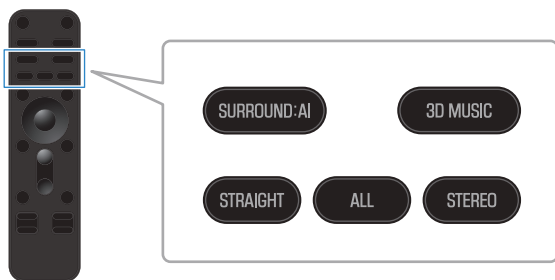

■ SURROUND:AI (p.97)

SURROUND:AI creates the optimum surround effect to suit the playback content.

■ 3D MUSIC (p.98)

Select your preferred upmixer from among AURO-3D, Dolby Surround, and Neural:X for surround playback.

■ STRAIGHT (p.99)

Playback without sound field effects is possible.

■ STEREO (p.100)

Stereo playback without sound field effects is possible.

■ ALL (p.78)

TRUE X SURROUND is available only when wireless speakers are connected. Audio output from the sound bar is played in stereo, and audio output from the wireless speakers is monaural.

Playback with surround sound effects matching the scene (SURROUND:AI)

SURROUND:AI creates the optimum surround effect to suit the playback content. It instantly analyzes and optimizes the scene in real time based on sound elements such as “dialog”, “background music”, “ambient sounds”, and “sound effects” to provide a realistic experience that will blow you away.

Press the SURROUND:AI key to set sound mode to “SURROUND:AI”.

NOTE

The default setting “SURROUND:AI” is set.

Selecting your favorite upmixer for surround playback (3D MUSIC)

Select your favorite upmixer for surround playback.

Press the 3D MUSIC key to set sound mode to “3D MUSIC”.

To select the upmixer, press the  (Setup) key to display “Sound” > “3D MUSIC Upmixer”. When the 3D MUSIC Upmixer screen appears, if a sound mode other than 3D MUSIC is selected, it will automatically switch to 3D MUSIC. The effect of the upmixer expands even a stereo input signal into 3D surround multi-channel sound including the height direction. The following are the upmixers that can be selected in “3D MUSIC Upmixer” > “Upmixer”.

- AURO-3D
Use AURO-3D.
It enables optimal expansion for the placement of the installed speaker. Be sure to use this setting for decoding and viewing AURO-3D content in AURO-3D.
- DSurr
Use Dolby Surround.
It enables optimal expansion for the placement of the installed speaker. This results in realistic sound from all directions, including overhead.
- Neural:X
Use DTS Neural:X.
It enables optimal expansion for the placement of the installed speaker. This results in realistic sound from all directions, including overhead.

NOTE

- When the 3D MUSIC Upmixer screen appears, if a sound mode other than 3D MUSIC is selected, it will automatically switch to 3D MUSIC.
- The default setting is “AURO-3D”.
- Regardless of which upmixer you select, virtual processing is also applied simultaneously.
- When using TRUE X SURROUND, virtual effects are applied as needed depending on the presence of wireless speakers.
- 3D MUSIC is not intended only for listening to music, but also to make the experience of watching films more immersive. Please use it according to your preference.

Related links

“Making audio settings” (p.118)

Playback the original audio (STRAIGHT)

Enables playback without applying surround sound effects. 2-channel sources are played back in stereo through the sound bar front speakers, and multi-channel sources are played back in multi-channel audio.

Press the STRAIGHT key to set sound mode to “STRAIGHT”.

NOTE

If the content being played does not contain height channel audio, the height speakers will not output any sound.

Stereo playback (STEREO)

This mode plays back stereo audio from the sound bar front speakers without applying surround sound effects.

Press the STEREO key to set sound mode to “STEREO”.

Emphasizing a specific range of sound (sound settings)

Enjoying rich bass sound (BASS EXT)

The acoustic image of bass sound is enhanced when the Bass Extension function is enabled. The subwoofer volume remains the same, but the overall acoustic image of bass sound is adjusted to be more clear. Therefore, the presence of the acoustic image of the bass sound can be emphasized without disturbing the balance of the overall sound. This function is recommended when you want to increase the bass while suppressing the volume of the subwoofer, or when you want to emphasize the sounds of low-pitched instruments.

Press BASS EXT key to enable or disable the function.

Playing back human voices clearly (CLEAR VOICE)

The human voices within the audio can be heard more easily without turning up volume when the Clear Voice function is enabled. The function is recommended for enjoying movies or dramas at a low volume, and for movies or dramas that use a lot of background music and sound effects.

Press CLEAR VOICE key to enable or disable the function.

NOTE

Clear Voice is a function focusing on emphasizing the sound quality of the human voice in narration and dialog during playback. Only the human voices are emphasized without changing the overall volume and frequency characteristics, and it gives a clear sense of localization to the human voices.

CONFIGURATION

Menus

Menu types

The sound bar provides the following menus.

■ Option menu

Shows sound bar playback settings and confirms audio and video signal information. Look at the TV screen while operating this menu.

■ Setup menu

Use to set detailed functions. Look at the TV screen while operating this menu.

■ Front display menu

Use to make system settings. Look at the front display while operating this menu.

NOTE

- The above menus cannot be used simultaneously. For example, the Setup menu cannot be used simultaneously with the front display menu.
- Later set menus take precedence.

Related links

- “Basic operations in the Option menu” (p.103)
- “Basic operations of the Setup menu” (p.111)
- “Basic operations in the front display menu” (p.134)

Checking playback settings and signal information (Option menu)

Basic operations in the Option menu

This section describes basic Option menu control operations.

Use the remote control while looking at the TV screen to operate this menu.

1 Press the ≡ (Option) key.

The Option menu screen appears.



2 Select a menu item.

3 Change the setting.

4 Press the ≡ (Option) key.

This completes the setting.

Related links

["Option menu list" \(p.104\)](#)

Option menu list

This is the Option menu list. For more information on menu items, refer to the links in the page column.

Item		Page
Adaptive Volume	Adaptive Volume	105
Audio Signal Information	Format	106
	Channel In	
	Channel Out	
	Sampling	
Video Signal Information	Dialogue	108
	Video In	
	Video Out	
	Color Format	
Auto Play	HDR	109
Volume Interlock	Auto Play	110
	Volume Interlock	

NOTE

Applicable items depend on input.

Automatic adjustment of high and low frequency range balance (Adaptive Volume)

Determines whether the balance of high and low frequencies should be automatically adjusted depending on sound volume.

When “On”, you can enjoy a natural balanced sound even at low volumes. A convenient function during low-volume night-time listening.

Option menu

“Adaptive Volume” > “Adaptive Volume”

Settings

Off	Disables Adaptive Volume.
On	Enables Adaptive Volume.

Confirming audio signal information

Allows you to confirm audio signal information.

Allows you to confirm audio format of the played back source, the number of input channels, etc.

■ Confirming audio signal format

Option menu

“Audio Signal Information” > “Format”

Displayed information

Indicates the audio format of input audio signals.

■ Allows you to confirm the number of channels of input audio signals

Option menu

“Audio Signal Information” > “Channel In”

Displayed information

The number of input audio signal channels are displayed in the following order: “Front/surround/subwoofer”.

For example, “3/2/0.1” means front 3 ch, surround 2 ch, LFE 0.1 ch.

■ Allows you to confirm the number of channels of the played back source being outputted

Option menu

“Audio Signal Information” > “Channel Out”

Displayed information

Number of output audio signal channels are displayed in the order “Front and surround. subwoofer. height”.

For example, if “5.1.2” is displayed, it means the 5.1 channels of the front and surround and of the subwoofer, and the 2 channels of the height (upper) speakers.

■ Confirming the sampling frequency range

Option menu

“Audio Signal Information” > “Sampling”

CONFIGURATION > Checking playback settings and signal information (Option menu)

Displayed information

Indicates the sampling frequency range of input audio signals.

■ Confirming dialog volume

Option menu

“Audio Signal Information” > “Dialogue”

Displayed information

Indicates the dialog volume level of input audio signals. The higher the level, the more the dialog is emphasized.

Confirming video signal information

Allows you to confirm video signal information.

Check the type of video signal being input, the number of frame rates, etc.

■ Confirming type of video signal being input

Option menu

“Video Signal Information” > “Video In”

Displayed information

Indicates the type, resolution and frame rate of input video signals.

■ Confirming the type of video signals being output

Option menu

“Video Signal Information” > “Video Out”

Displayed information

Indicates the type, resolution and frame rate of output video signals.

■ Confirming video signal format

Option menu

“Video Signal Information” > “Color Format”

Displayed information

Indicates the color format of input video signals.

■ Confirming high dynamic range format

Option menu

“Video Signal Information” > “HDR”

Displayed information

Displays the high dynamic range method of the input video signal.

Setting auto playback

Set whether content from streaming services and other content should be played back automatically when network input is selected.

Option menu

“Auto Play” > “Auto Play”

Settings

Off	Disable auto playback.
On	Always enable automatic playback of the most recently played content.
Auto	Enable automatic playback only of content whose playback was interrupted by a power off (standby).

NOTE

- “Auto” cannot be selected for a “Bluetooth” input source.
- Some input sources and content may not be played back automatically.

Set the volume linking the AirPlay playback device and the sound bar

When AirPlay is selected for input, set whether the volume of the sound bar and AirPlay device should be linked. If something other than “Off” is set, the volume of the sound bar can be adjusted from the AirPlay device.

Option menu

“Volume Interlock” > “Volume Interlock”

Settings

Off	Disable volume control from AirPlay device.
Limited	Enable mute and volume control in the range 0 to 60.
Full	Enable mute and volume control in the range 0 to 100.

Setting functions (Setup menu)

Basic operations of the Setup menu

This section describes basic Setup menu control operations.

Use the remote control while looking at the TV screen to operate this menu.

1 Press the ⚙️ (Setup) key.

2 Select menu.

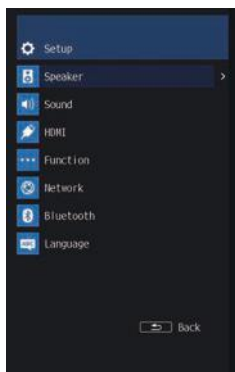

3 Select a menu item.

4 Change the setting.

5 Press the ⚙️ (Setup) key.

This completes the setting.

NOTE

- A message will inform you when new firmware becomes available.
- If there is new firmware on the network, an 📧 icon will appear in the lower left corner of the screen in the Setup menu.

Related links

“Setup menu list” (p.112)

Setup menu list

This is the Setup menu list. For more information on menu items, refer to the links in the page column.

■ Speaker

Item		Page
Beam	Angle	Height L Height R
	Focal Length	Height L Height R
	Ceiling Height	
	Test Tone	
Level	Front L	
	Front R	
	Center	
	Height L	
	Height R	
	Subwoofer	
	Surround L Surround R Surround	
Registration		

■ Sound

Item		Page
Tone Control	Treble	
	Bass	
3D MUSIC Upmixer	Upmixer	
	AURO-3D	Auro-Matic Preset Auro-Matic Strength
Auto Lipsync		
DTS Dialogue Control		
Volume	Dynamic Range	
	Max Volume	
	Initial Volume	

■ HDMI

Item	Page
HDMI Control	121
Audio Output	121
Pass Through	121
HDCP Version	121
ARC	121

■ Function

Item	Page	
Display Settings	Dimmer	124
	Short Message	
Power Management	Auto Power Standby	124
	True X Ready	
Initialization	124	
Firmware Update	124	

■ Network

Item	Page
Information	127
Network Connection	127
IP Address	127
DMC Control	127
Network Standby	127
Network Name	127
MusicCast Link Power Interlock	127

■ Bluetooth

Item	Page	
Bluetooth	131	
Audio Receive	Disconnect	131
	Transmitter	
Audio Send	Device Search	131

■ **Language**

Item	Page
Language	133

Configuring the speakers

■ Beam

The viewing environment may not make it possible for the default settings to provide an adequate surround sound effect. In such cases, the surround sound effect can be improved by adjusting the beam angle, focal length, and ceiling height.

About Beam (Sound Beam)

- This sound bar uses sound beam technology for height channel playback. Sound beam technology is a technology that uses a digital signal processor (DSP) to individually control the audio output from the array speakers (multiple small speaker units arranged in a row) located toward the ceiling at the left and right ends of the sound bar to create a beam-like high directivity characteristic in a specific direction. This technology generates a beam-like high directivity characteristic in a specific direction. The height channels use sound beams to reflect sound off the ceiling creating an effect that make it seem the sound comes from speakers embedded in the ceiling.



Angle

Adjusts the height beam output angle (vertical) for left and right respectively.

- Setup menu
“Speaker” > “Beam” > “Angle” > “Height L”/“Height R”
- Settings
30° to 90°
 - 90° is straight up.
- Default setting
72°

Focal Length

Adjusts the height beam width (sweet spot) for left and right respectively.

Refer to the following illustration for the focal length.

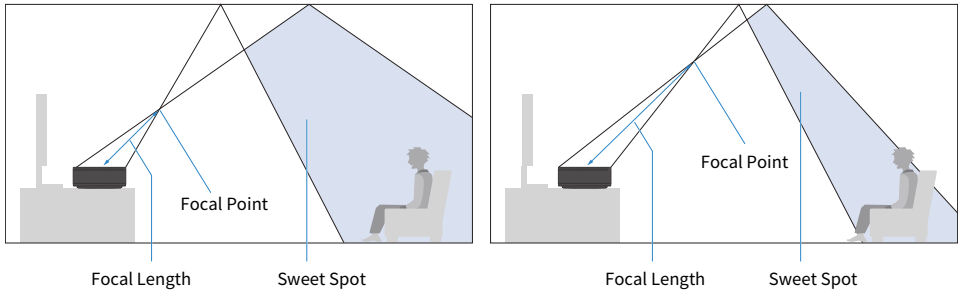

- Setup menu
“Speaker” > “Beam” > “Focal Length” > “Height L”/“Height R”
- Settings
1.0 m to 3.0 m
- Default setting
1.8 m

Ceiling Height

Adjusts to suit the ceiling height of the used room.

- Setup menu
“Speaker” > “Beam” > “Ceiling Height”
- Settings
1.0 m to 4.0 m
- Default setting
2.5 m

NOTE

- When “Angle”, “Focal Length” are selected, a test tone is automatically played.
- In “Focal Length” and “Ceiling Height”, under “Unit”, you can switch between “Meter” and “Feet”.
If the “Unit” setting is switched, the “Focal Length” setting will return to its default value. Then change the setting again.
- The beam can be used in the following sound modes.
 - SURROUND:AI
 - 3D MUSIC (“3D MUSIC Upmixer” > “Upmixer” is AURO-3D / DSurr (Dolby Surround) / Neural:X)
 - STRAIGHT
- In AURO-3D or Dolby Surround playback, “Ceiling Height” cannot be adjusted.

■ Level

Adjusts the volume for each channel.

Test Tone

- Setup menu
“Speaker” > “Level” > “Test Tone”
- Settings

Off	Test tone is not played.
On	Test tone is played.

NOTE

- After turning “Test Tone” to “On”, press the ↵ (Return) key to select the channel whose volume you want to adjust when returning to the “Level” screen and you can adjust the volume while playing a test tone from the selected channel.
- Closing the Setup menu while the “Test Tone” is still set to “On” will stop the test tone.
- When test tone is used, it is possible to check whether the wireless speakers are connected or whether sound is coming from the wireless speakers when TRUE X SURROUND is used.

Channel selection

- Setup menu
Under “Speaker” > “Level”, select the channel for which to adjust the level.
- Settings
-20 to +20

NOTE

- You can listen to the test tone from each channel by playing the test tone and applying the cursor to it. Adjust the volume by comparing the sound from the front and center with the sound from the subwoofer or wireless speakers.
- “Surround L”, “Surround R”, and “Surround” can also be adjusted with the SURROUND L/R keys on the remote control.

■ Registration

Turn on the subwoofer and the wireless speakers.

Setup menu

“Speaker” > “Registration”

Settings

Registration	Start registration.
Clear	Clear registrations.

NOTE

- “Registered” is displayed on beside the name of a registered speaker.
- Selecting “Clear” removes all speaker registrations from the sound bar.
- If a wireless speaker firmware update fails three times, “ERROR XXXXXX” (“XXXXXX” is the error number) is displayed beside the name of the speaker.
Contact your dealer or service center if an error occurs.

Making audio settings

■ Tone Control

This function separately adjusts the volumes of the high and low frequency ranges.

Setup menu

“Sound” > “Tone Control” > “Treble”/“Bass”

Settings

-12 to +12

Default setting

0

■ 3D MUSIC Upmixer

By selecting this menu, the sound mode switches to “3D MUSIC”, and you can select your favorite upmixer to change the effect.

Upmixer

- Setup menu
“Sound” > “3D MUSIC Upmixer” > “Upmixer”
- Settings

AURO-3D	Use AURO-3D. It enables optimal expansion for the placement of the installed speaker. Be sure to use this setting for decoding and viewing AURO-3D content in AURO-3D. By selecting “AURO-3D” for “Upmixer”, the “AURO-3D” menu becomes enabled.
DSurr (Dolby Surround)	Use Dolby Surround. It enables optimal expansion for the placement of the installed speaker. This results in realistic sound from all directions, including overhead.
Neural:X	Use DTS Neural:X. It enables optimal expansion for the placement of the installed speaker. This results in realistic sound from all directions, including overhead.

- Default setting
AURO-3D

NOTE

When the 3D MUSIC Upmixer screen appears, if a sound mode other than 3D MUSIC is selected, it will automatically switch to 3D MUSIC.

AURO-3D

Set to AURO-3D when “AURO-3D” is selected on the “3D MUSIC Upmixer”.

CONFIGURATION > Setting functions (Setup menu)

- Setup menu

“Sound” > “3D MUSIC Upmixer” > “AURO-3D” > “Auro-Matic Preset” / “Auro-Matic Strength”

- Settings

Auro-Matic Preset

An Auro-Matic Upmixer Preset used to effectively play back AURO-3D in accordance with content. Select one of following presets as required by playback content.

Small	Preset for pop music and chamber music.
Medium	Preset for jazz music, general movies, and TV programs.
Large	Preset for content recorded in a large space, such as an orchestra.
Movie	Preset for movie content, such as action movies with loud explosion scenes.
Speech	This preset is best suited for news broadcasts and other content that is mostly dialog which does not have spatial information.

Auro-Matic Strength

Sets the level of upmixing for the original input signal.

0 to 15	Brightness level is set in 1 step increments.
---------	---

- Default setting

- Auro-Matic Preset: Medium
- Auro-Matic Strength: 12

■ Auto Lipsync

Automatically compensates for the delay between the timing of the output of the video and the audio.

Setup menu

“Sound” > “Auto Lipsync”

Settings

Off	Disables compensation using Auto Lipsync.
On	Enables compensation using Auto Lipsync.
	Enabled only on a TV with automatic compensation connected using HDMI.

Default setting

On

■ DTS Dialogue Control

Adjusts the volume of dialog that is difficult to hear during playback of DTS:X content.

Setup menu

“Sound” > “DTS Dialogue Control”

Settings

0 to 6

Default setting

0

NOTE

Can be set only with DTS:X content supporting DTS Dialogue Control.

■ Volume

Setup menu

“Sound” > “Volume” > “Dynamic Range”/“Max Volume”/“Initial Volume”

Settings

- Dynamic Range
Sets how the dynamic range (difference between maximum and minimum volume) is adjusted during playback of Dolby Digital and DTS signals.

Maximum	Playback the input signal without correction.
Standard	Playback with a dynamic range suitable for home use.
Min/Auto	Playback with a dynamic range suitable for nighttime or low volume listening. Dolby TrueHD playback is based on input signal information.

- Max Volume
Sets the upper limit value to which the volume can be adjusted using the VOLUME +/- keys on the remote control or other keys.

40 to 100

- Initial Volume
Sets the sound volume when the power is turned on.

Off	Set the volume to the level it had when the power was most recently put on standby.	
	Mute	Mute the sound.
On	1 to 100	Use the set volume. Enabled only when set to a value lower than “Max Volume”.

Default setting

- Dynamic Range: Maximum
- Max Volume: 100
- Initial Volume: Off

Making HDMI settings

■ HDMI Control

Set operation of HDMI Control TV and AV devices to link with sound bar operations.

Setup menu

“HDMI” > “HDMI Control” > “HDMI Control”

Settings

Off	Disables HDMI Control.
On	Enables HDMI Control. The “ARC” setting is applied.

Default setting

Models for U.K. and Europe: Off

Models for other areas: On

NOTE

Setting the “HDMI Control” to “On” consumes more power than when it is set to “Off”.

■ Audio Output

Sets whether audio is output from the speakers of an HDMI-connected TV.

Setup menu

“HDMI” > “Audio Output”

Settings

Off	The TV does not output audio.
On	The TV will output audio.

Default setting

Off

NOTE

Can be set only when “HDMI Control” is “Off” in the Setup menu.

■ Pass Through

Sets whether the audio/video input to the HDMI IN jack is output to a TV connected to the HDMI OUT jack when the soundbar is turned off (standby).

Setup menu

“HDMI” > “Pass Through” > “Pass Through”

Settings

Off	Audio/video is not output to TV.
On	Audio/video is output to TV. Consumes more power than when set to “Off”, “Auto”.
Auto	Automatically determines whether to output audio/video to the TV depending on the status of the connected devices.

Default setting

Auto

NOTE

- When “Pass Through” is set to “On” or “Auto”, it consumes more power than when set to “Off”.
- When “HDMI Control” is set to “On” in the Setup menu, only “On” and “Auto” can be selected.

■ HDCP Version

Sets the HDCP version of the HDMI IN jack. Set as required during 4K viewing.

Setup menu

“HDMI” > “HDCP Version”

Settings

Auto	The HDCP version is automatically determined by the content.
1.4	The HDCP version is fixed at 1.4.

Default setting

Auto

■ ARC

When “HDMI Control” in the Setup menu is set to “On”, this setting determines whether TV audio is output from the sound bar.

Setup menu

“HDMI” > “ARC”

Settings

Off	Disables ARC.
On	Enables ARC.

CONFIGURATION > Setting functions (Setup menu)

Default setting

On

NOTE

Normally, there is no need to change the setting from “On” (the default value). Set to “Off” only when noise is generated by an audio signal not supported by the sound bar is input from a TV. Use the TV speakers if this happens.

Setting up detailed function settings (Function)

■ Display Settings

Set the display settings for TV screen on the front display.

Setup menu

“Function” > “Display Settings” > “Dimmer”/“Short Message”

Settings

- Dimmer

Adjust the brightness of the power indicator and the front display. A higher value means brighter light.

-5 to 0

- Short Message

Sets the location where short messages are displayed during soundbar operation.

Off	The short message is not displayed.	
On	Displays the short message.	
Position	Bottom	Displayed at the bottom of the screen.
	Top	Displayed at the top of the screen.

Default setting

- Dimmer: -2
- Short Message: On (Position: Bottom)

NOTE

- Even if set to “-5” (off), short messages and menus on the front display menu will still be displayed at a brightness of “-4”.
- When set to “-5” (off), it will be more difficult to see whether or not the sound bar is on. Take care not to leave the sound bar with the power on. You are recommended to set “Auto Power Standby” in the Setup menu to something other than “Off”.
- The “Dimmer” setting in the Setup menu and the “Dimmer” setting on the front display menu are interlocked.

■ Power Management

Auto Power Standby

Sets the time it takes for the sound bar to turn off (standby) automatically.

- Setup menu
“Function” > “Power Management” > “Auto Power Standby”
- Settings

Off	Do not automatically put on standby. Setting to “Off” consumes more power than setting to the selections other than “Off”.
-----	---

5 minutes, 20 minutes	Standby when the sound bar has not been operated for a specified period of time and no input signal has been detected for a specified period of time.
2 hours, 4 hours, 8 hours, 12 hours	Put the sound bar in standby mode when it has not been operated for a specified period of time.

- Default setting
20 minutes

True X Ready

Select whether to maintain the connection to the wireless speakers when the sound bar is off.

- Setup menu
“Function” > “Power Management” > “True X Ready”
- Settings

Off	Minimizes the power consumption of the sound bar, but it takes longer for the wireless speakers to connect.
On	Increases the power consumption of the sound bar, but shortens the time it takes for the wireless speakers to connect.

- Default setting
Models for U.K. and Europe: Off
Models for other regions: On

NOTE

- Setting the “True X Ready” to “On” consumes more power than when it is set to “Off”.
- It is recommended that “True X Ready” be set to “On” for smooth power interlocking with the wireless speakers.

■ Initialization

Reset (initialize) the settings of the sound bar.

Setup menu

“Function” > “Initialization”

Settings

All	Initializes all settings.
Network	Initializes the network settings.

Operation method

Refer to “To initialize (reset) the sound bar” (p.182) for information on the operation method.

NOTE

You can also use “Initialization” in the front display menu to initialize a setting.

■ Firmware Update

Update the sound bar's firmware. You can also confirm the version of current firmware and the system ID.

Setup menu

“Function” > “Firmware Update”

Settings

Network Update	Update performed via a network.
USB Update	Update using a USB flash drive.

Operation method

Refer to “Firmware Update” (p.140) for information on the operation method.

NOTE

- You cannot select “Network Update” until you are ready to update the firmware.
- Use this menu only for updating firmware. Before updating, be sure to check for important information on our web site.
- A firmware update via a network takes about 20 minutes.
- If your Internet connection is not fast enough or you are using a wireless network, you may not receive notice of a firmware update. In such a case, it may be better to use a USB flash drive to update the firmware.
- You can also use “Firmware Update” in the front display menu to update firmware.
- After the firmware of the sound bar has been updated, the firmware of the wireless speakers may be updated automatically.

Setting up a network

■ Information

Displays information for connecting the sound bar to a network.

Setup menu

“Network” > “Information”

Displayed information

Status	The status of the network jack
Connection	Method for making a network connection
SSID	The access point to which the sound bar is connected to when using a wireless connection (Wi-Fi)
MusicCast Network	Status of MusicCast network registration
MAC Address (Ethernet)	Sound bar MAC address
MAC Address (Wi-Fi)	Sound bar MAC address
IP Address	Sound bar IP address
Subnet Mask	Subnet mask
Default Gateway	IP address for default gateway
DNS Server (P)	Primary DNS server IP address
DNS Server (S)	Secondary DNS server IP address

■ Network Connection

Use to configure settings to connect the sound bar to a network.

Setup menu

“Network” > “Network Connection”

Settings

Wired	Connecting to a network using a network cable.
Wireless(Wi-Fi)	Connecting to a wireless network.

Default setting

Wired

NOTE

- To make a cable connection, refer to “Connecting to a network using a LAN cable (wired connection)” (p.43).
- To make a wireless connection, refer to “Selecting a wireless connection method to a network” (p.192).

■ IP Address (DHCP function)

Use the DHCP server to automatically set the network information (IP address, subnet mask, default gateway, etc.) of the sound bar for the sound bar using a DHCP server.

Setup menu

“Network” > “IP Address” > “DHCP”

Settings

Off	Set the network information manually without using a DHCP server. To set network information, refer to “Manually setting network information”.
On	Use a DHCP server to set network information automatically.

Default setting

On

Manually setting network information

- 1 For “DHCP”, select “Off”.
- 2 Select the item you want to set.
- 3 Set network information.
- 4 Press the ENTER key.
- 5 To set other items, repeat steps 2 to 4.
- 6 Press the  (Setup) key.

This completes the setting.

■ DMC Control

Sets whether the sound bar is operated from a digital media controller (DMC). When enabled, sound bar playback can be controlled from a DMC on the same network as the sound bar.

Setup menu

“Network” > “DMC Control”

Settings

Disable	Disables operations from DMC.
Enable	Enables operations from DMC.

Default setting

Enable

■ Network Standby

Sets whether the sound bar will be turned on from a network device.

Setup menu

“Network” > “Network Standby”

Settings

Off	Disables Network Standby.
On	Enables Network Standby. Consumes more power than when set to “Off”.
Auto	Enables Network Standby. When “Network Connection” is set to “Wired”, and the network cable is disconnected, the sound bar enters the power save mode to save power.

Default setting

Auto

NOTE

- In power save mode, the sound bar cannot be turned on from network devices even when a power cable is connected. Turn on the sound bar manually.
- If “Network Standby” is set to “Off”, the sound bar cannot be turned on from a device, not even a Bluetooth device that has already been paired with the sound bar. Turn on the sound bar manually.

■ Network Name

This sets the name of the sound bar that is displayed to the network (its network name).

Setup menu

“Network” > “Network Name”

Setup procedure

- 1 Press the ENTER key.
- 2 Edit the name.
- 3 Select “OK”.
- 4 Press the  (Setup) key.

This completes the setting.

NOTE

- Select “CLEAR” to delete all entered data.
- If “RESET” is selected, the default for the name of the sound bar (its network name) is displayed.

■ MusicCast Link Power Interlock

When the sound bar (master) is turned on, set whether the MusicCast devices (secondary devices) are also turned on.

Setup menu

“Network” > “MusicCast Link Power Interlock”

Settings

Off	The power function of the sound bar and MusicCast devices are not linked.
On	The power function of the sound bar and MusicCast devices are linked.

Default setting

Off

Configuring the Bluetooth function

■ Bluetooth

Set whether the Bluetooth function will be used.

Setup menu

“Bluetooth” > “Bluetooth”

Settings

Off	Disables the Bluetooth function.
On	Enables the Bluetooth function.

Default setting

On

■ Disconnect

Disconnects the Bluetooth device from the sound bar.

Setup menu

“Bluetooth” > “Audio Receive” > “Disconnect”

Setup procedure

Select “Disconnect” and press the ENTER key to cancel the Bluetooth connection.

NOTE

Unconnected Bluetooth devices cannot use this function.

■ Audio Send

Use Bluetooth devices (speakers/headphones, etc.) to listen to audio played on the sound bar.

Setup menu

“Bluetooth” > “Audio Send” > “Transmitter”

Settings

Off	Disables the Bluetooth audio transmission function.
On	Enables the Bluetooth audio transmission function.

Default setting

Off

■ Device Search

When the “Transmitter” is set to “On” in the Setup menu, connect the Bluetooth device (speaker/headphones, etc.) to be used for audio transmission.

Set the Input of the sound bar to something other than Bluetooth.

Setup menu

“Bluetooth” > “Audio Send” > “Device Search”

Setup procedure

- 1 Check the message and press the ENTER key.
A Bluetooth device that can be connected to the sound bar appears.
- 2 Select the Bluetooth device for sending audio.
- 3 Press the ENTER key.

When the connection is completed, “Completed” will be displayed.

- 4 Press the ENTER key.

This completes the setting.

NOTE

- If the Bluetooth device you wish to connect does not appear in the list, pair the Bluetooth device and then perform the “Device Search” again.
- To terminate the connection, turn off the Bluetooth speakers/headphones.

Language settings

■ Language

Set the interface language for the Setup menu and other menus.

Setup menu

“Language”

Settings

English	English
日本語	Japanese
Français	French
Deutsch	German
Español	Spanish
Русский	Russian
Italiano	Italian
中文	Chinese

Making settings from the sound bar (front display menu)

Basic operations in the front display menu

Describes how to use the basic front display menu functions. Use the remote control while looking at the front display to operate this menu.

1 Press the  (Front Display Menu) key on the remote control.

The menu list screen appears.

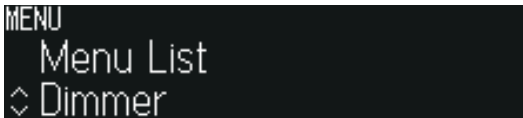

2 Select a menu item.

3 Change the setting.

4 Press the  (Front Display Menu) key.

This completes the setting.

NOTE

To cancel operation in the front display menu, or to return to a previous display, press the  (Return) key on the remote control.

Related links

“Front display menu list” (p.135)

Front display menu list

This is the front display menu list. For more information on menu items, refer to the links in the page column.

Item	Page
Dimmer	136
Child Lock	137
Initialization	All Initialization
	Network Initialization
Firmware Update	Network Update
	USB Update

Adjusting the brightness of front display and the power indicator (Dimmer)

Adjust the brightness of the front display and the power indicator. A higher value means brighter light.

Front display menu

“Dimmer”

Settings

-5 to 0

Default setting

-2

NOTE

- “-5” indicates off.
- Even if set to “-5” (off), short messages and menus on the front display menu will still be displayed at a brightness of “-4”.
- When set to “-5” (off), it will be more difficult to see whether or not the sound bar is on. Take care not to leave the sound bar with the power on. You are recommended to set “Auto Power Standby” in the Setup menu to something other than “Off”.
- The “Dimmer” setting in the Setup menu and the “Dimmer” setting on the front display menu are interlocked.

Enabling/disabling the Child Lock function

Enabling the Child Lock function locks the controls of the sound bar to prevent accidental operation.

Front display menu

“Child Lock”

Settings

Off	Disables the Child Lock function.
On	Enables the Child Lock function.

Default setting

Off

NOTE

The power button cannot be locked.

Initializing the sound bar

Reset (initialize) the settings of the sound bar.

Front display menu

“Initialization”

Item

All Initialization	Initializes all settings.
Network Initialization	Initializes the network settings.

Operation method

Refer to “To initialize (reset) the sound bar” (p.182) for information on the operation method.

NOTE

You can also use “Initialization” in the Setup menu to initialize settings.

Updating the firmware

Update the sound bar's firmware. You can also confirm the version of current firmware.

Front display menu

"Firmware Update"

Settings

Network Update	Update performed via a network.
USB Update	Update using a USB flash drive.

Operation method

Refer to "Firmware Update" (p.140) for information on the operation method.

NOTE

- You cannot select "Network Update" until you are ready to update the firmware.
- Use this menu only for updating firmware. Before updating, be sure to check for important information on our web site.
- A firmware update via a network takes about 20 minutes.
- If your Internet connection is not fast enough or you are using a wireless network, you may not receive notice of a firmware update. In such a case, it may be better to use a USB flash drive to update the firmware.
- You can also use "Firmware Update" in the Setup menu to update firmware.

UPDATING THE FIRMWARE

Firmware Update

New firmware is provided to add features or fix bugs. For more information about firmware, visit the Yamaha website. Firmware can be updated via the Internet or using a USB flash drive.

■ Notification of a firmware update

App notification

If you are using the MusicCast Controller smartphone application, it will notify you when a firmware update becomes available.

Front display notification

When the sound bar is ready to accept new firmware, the firmware update icon on the front display will glow.



Firmware Update icon

NOTE

- If a more recent version of firmware becomes available before an update is performed, the firmware update indicator may temporarily turn off.
- If your Internet connection is not fast enough or you are using a wireless network, you may not receive notice of a firmware update. In such a case, it may be better to use a USB flash drive to update the firmware.
- The front display example shown here is an English screen.

Related links

- “Updating the firmware via a network” (p.141)
- “Updating the firmware with a USB flash drive” (p.143)

Updating the firmware

Updating the firmware via a network

NOTICE

- Do not operate the sound bar or unplug the power cord or network cable while updating the firmware. In the unlikely event that this process is interrupted, it may not be possible to use the sound bar. In that case, you may have to take it in to have it repaired.

■ Update using the application

If you are using the MusicCast Controller smartphone application, it will notify you when a firmware update becomes available.

Follow the app screen instructions to update the firmware.

■ Updating from the Setup menu

If the sound bar is connected to the Internet, when the sound bar is ready to update to new firmware, the  (Firmware Update) icon on the front display will glow.



Firmware Update icon

In the situation described above, press the  (Setup) key and the following message will appear.



You can use the right and left cursor keys to switch languages.

In that screen, follow the following instructions to update the firmware.

1 Read the instructions on the screen and press the bottom cursor key.

The following screen appears.

2 Check the information on the screen and press the ENTER key.

The TV screen clears and the firmware update starts.

3 When the message “UPDATE SUCCESS PLEASE POWER OFF!” appears, press the power button on the sound bar.

This completes the firmware update.

NOTE

- A firmware update takes about 20 minutes.
- If your Internet connection is not fast enough or you are using a wireless network, you may not receive notice of a firmware update. In such a case, it may be better to use a USB flash drive to update the firmware.
- After the firmware of the sound bar has been updated, the firmware of the wireless speakers may be updated automatically.

■ The firmware is updated when the power is turned off

If you are currently unable to update firmware, make a reservation and the update will be performed the next time the sound bar is powered off.

Proceed as follows.

1 Press the cursor down key instead of the ENTER key in step 2 of “Updating the firmware via a network”.

2 Press the ENTER key in the next screen.

A firmware update is reserved.

If you schedule a firmware update, a message asking you to confirm whether you want to perform the update will appear on the front display when you turn off the power.

Press the ENTER key to start the update. The power is automatically turned off when the update is complete.

NOTE

- After 2 minutes have elapsed since the update confirmation screen is displayed, the power will turn off without updating.
- Press the ⇨ (Return) key to cancel the update and the power is turned off.
- When the sound bar is turned off by the MusicCast Controller, the power is turned off without updating the firmware.
- After the firmware of the sound bar has been updated, the firmware of the wireless speakers may be updated automatically.

Updating the firmware with a USB flash drive

Use a USB flash drive to update the firmware when the sound bar is not connected to the Internet or when the speed of your Internet connection is not fast enough.

Please visit the Yamaha website for details on how to download the firmware.

1 Download the latest version of the firmware for the soundbar to your computer from the Yamaha website.

For more information, visit the product information page on the Yamaha website.

2 Extract the downloaded compressed file, and save the firmware data file to the USB flash drive.

Be sure to save only the firmware data file to the top folder (root folder) of the USB flash drive.

Do not change the name of the data file.

3 Connect the USB flash drive to the UPDATE ONLY jack on the rear of the sound bar.

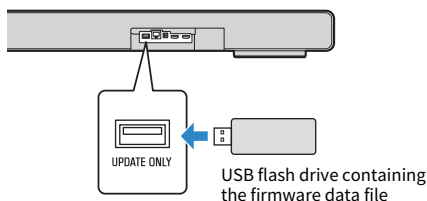

4 Press the (Setup) key on the remote control.

5 Select “Function” > “Firmware Update” > “USB Update” from the Setup menu on the TV screen.

The firmware update will start. Never turn off the power while updating the firmware.

6 When the message “UPDATE SUCCESS PLEASE POWER OFF!” appears on the front display, turn off the sound bar.

7 Make sure that the sound bar is turned off, and then remove the USB flash drive.

This completes the firmware update.

NOTICE

- Do not operate the sound bar or unplug the power cord or network cable while updating the firmware. In the unlikely event that this process is interrupted, it may not be possible to use the sound bar. In that case, you may have to take it in to have it repaired.
- If you are using TRUE X SURROUND, be sure to update the firmware while the wireless speakers are connected.

NOTE

You can also update the firmware by selecting “Firmware Update” > “USB Update” in the menu on the front display.

Front display error messages

During the firmware update, an error message such as those below may appear on the front display. Try the corresponding solution.

Message	Solution
NOT FOUND	The update file is not on the USB flash drive. Check if the update file is on the USB flash drive.
DEVICE ERROR	Access to the USB flash drive failed. The USB flash drive may not have been properly inserted or may be damaged. Check the USB flash drive.
INVALID FILE	The update file stored on the USB flash drive may be corrupted. Save the latest update file.
Version Error	Updating the firmware failed. Perform the update again.
ERROR! XXXXXX (“XXXXXX” is the error number)	The sound bar firmware update failed. Perform the update again.
Update failed XXXXXX (“XXXXXX” is the error number)	The firmware update of the wireless speakers ended in error. Turn the wireless speaker off, then turn it back on again. Then, unplug the power cord of the subwoofer from the AC wall outlet, and when the power indicator goes off, plug the power cord back in again.

NOTE

If the wireless speaker firmware update fails three times, no further update will be performed. In that case, the error message “ERROR XXXXXX” will appear in the Setup menu on the “Speaker” > “Registration” screen. Contact the nearest authorized Yamaha dealer or service center.

TROUBLESHOOTING

Check the following first

Make sure of the following when the sound bar does not function properly.

- The power plugs of the soundbar, TV, and AV equipment (Blu-ray Disc players, etc.) are securely connected to a power outlet.
- The sound bar, subwoofer, TV and AV devices (Blu-ray Disc players, etc.) are turned on.
- The connectors of each cable are securely inserted into the jacks on each device.

Power and overall functionality

The power turns off suddenly

● **The Auto Power Standby function turned off the power.**

When the Auto Power Standby function is on, it will turn off the sound bar automatically according to the conditions you set.

Turn on the sound bar again. The Auto Power Standby function can be disabled.

- “Setting up detailed function settings (Function)” (p.124)

● **The protection circuitry has been activated (The power indicator on the sound bar flashes red).**

Make sure that the power indicator is correctly connected before turning on the power again. If the power still turns off frequently, unplug the power cord from the AC wall outlet and contact the nearest authorized Yamaha dealer or service center.

The power cannot be turned on

- **The protection circuitry has been activated three times consecutively (The power indicator on the sound bar flashes red).**

To protect the product, the power cannot be turned on. Unplug the power cord from the AC wall outlet and contact the nearest authorized Yamaha dealer or service center.

No operations can be performed from the sound bar controls

● **The Child Lock function is enabled (the controls are locked).**

Disable the Child Lock function (to unlock the controls).

- “Enabling/disabling the Child Lock function” (p.137)

Front display is off when power is on (the power appears to be off)

- **Brightness for the front display is set to “Off”.**

Make sure that the Dimmer is set to “-4” or more.

- “Adjusting the brightness of front display and the power indicator (Dimmer)” (p.136)

The sound bar does not function correctly

- **The internal microcomputer is frozen due to an external electric shock (such as lightning or excessive static electricity) or to a drop in the power supply voltage.**

Press the power button on the sound bar for at least 10 seconds to force the sound bar to turn off. Then disconnect the power cord of the subwoofer from the AC wall outlet. Make sure the power indicator is off before plugging the power cord of the subwoofer back in and turn on the sound bar again.

The sound bar turns on even though no operation was performed

- **Another Bluetooth device is being operated nearby.**
Terminate the Bluetooth connection with the sound bar.
- **Another device is playing AirPlay, Spotify, etc. nearby.**
Disconnect the sound bar from the playback device.
- **The soundbar is selected as the playback device in MusicCast Controller.**
Set the playback device to a desired device other than the soundbar.

The sound bar cannot be controlled with the remote control

- **The sound bar is out of the operating range.**

Use the remote control within the operating range.

- **The battery in the remote control has run out.**

Replace the battery with a new one.

- **The remote control sensor of the sound bar is exposed to direct sunlight or strong lighting.**

Adjust the lighting angle or reposition the sound bar.

The sound bar cannot be controlled using the TV's remote control

● **The HDMI Control function is not properly configured.**

Confirm that the settings are properly configured as follows:

- The HDMI Control function of the sound bar is On
“Making HDMI settings” (p.121)
- The HDMI Control function of the TV is On
- In the TV's HDMI settings, the audio output destination is set to an option other than the TV's built-in speakers

If the sound bar still cannot be controlled with the TV's remote control, perform the following:

- Turn off the sound bar and the TV, and then turn them back on again
- Unplug the power cord of the sound bar, as well as the power cords of external devices connected to the sound bar via an HDMI cable, from the AC wall outlet. Wait for 30 seconds before plugging them in again

● **The TV does not support the sound bar's control functions.**

Even if your TV supports the HDMI Control function, some functions may not be available. For details, see the documentation supplied with your TV.

● **Devices no longer start up simultaneously due to a power failure or for some other reason.**

Disconnect the HDMI cable and the power cable, leave the system to discharge for five minutes. Then, reconnect the cables in the following order: AV devices (if connected), the sound bar and TV.

Sound bar input source not displayed on a TV

Check that all connections to the TV are properly made.

To check connection status, press the INFO button repeatedly until the front display shows HDMI status.

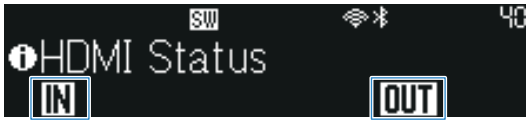

Indicates whether an input or output signal has been made to the HDMI IN, HDMI OUT/TV (eARC) jack.

IN: HDMI input

OUT: HDMI output

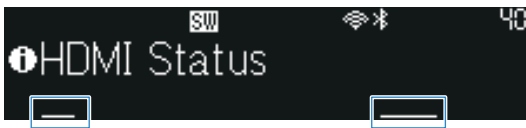

An underline is displayed if no sound is output.

● **IN is not displayed, and an underline is displayed.**

The input signal is not recognized. If the power of the AV device is turned on but **IN** does not light up, make sure the HDMI cable is securely connected at both ends between the sound bar and the AV device that is connected to the HDMI IN jack of the sound bar.

● **OUT is not displayed, and an underline is displayed.**

The signal is not being output. Make sure that the HDMI cable connecting the TV and sound bar is securely connected to both ends.

● **IN or OUT flashes repeatedly.**

- The HDMI cable may not be securely connected. Make sure that the HDMI cable connecting the TV and sound bar is securely connected to both ends.
- If the connection is stable, but **IN** or **OUT** is flashing repeatedly, there may be a problem with the HDMI cable. Replace the HDMI cable.

● **The flashing of the OUT does not affect TV reception.**

- Select sound bar on the TV input. For information on how to switch, refer to the instruction manual for your TV.
- If you switch the TV input to the sound bar and still cannot see the image, there may be a problem with the HDMI cable. Replace the HDMI cable.

Audio playback

No sound

- **The input source you are attempting to play back from is not selected.**

Select the correct input source.

- “Basic control during playback” (p.83)

- **The mute function is active.**

Cancel the mute function.

- “Basic control during playback” (p.83)

- **The volume is too low.**

Turn up the volume.

- “Basic control during playback” (p.83)

- **The power cord of the sound bar is not connected securely.**

Make sure that the power cord of the sound bar is properly connected to an AC wall outlet.

- **The sound bar has just been started up.**

The sound bar does not produce a sound for the first 30 seconds. In the meantime, the front display will show a “Please wait” message. Wait awhile before proceeding.

- **An input jack is connected to another input jack.**

Connect the input jack on the sound bar to the output jack on the AV device. When connecting the AV device to the TV, connect the output jack on the AV device to the input jack on the TV.

- “Connecting an AV device to the sound bar” (p.39)
- “Connecting an AV device to the TV’s HDMI input jack” (p.40)

- **A signal that the sound bar cannot play is being input.**

Change the digital audio output setting on the TV or AV device to a type of audio signal supported by the sound bar.

- “Supported digital audio signal formats” (p.190)

- **The HDMI Control function is set to Off.**

When connecting a TV supporting the Audio Return Channel (ARC) to the sound bar using only an HDMI cable, turn On the HDMI Control function.

To output audio from the sound bar when the HDMI Control function is turned Off, connect the TV’s audio output jack to the OPTICAL jack (digital optical) on the sound bar using a digital optical audio cable.

- “Making HDMI settings” (p.121)

- **The audio output destination of a TV using HDMI Control function is the built-in speakers of the TV.**

In the TV’s HDMI settings, set the audio output destination to an option other than the TV’s built-in speakers.

- **A DVD-Audio or an SACD is being played back.**

Playback of DVD-Audio and SACD is not supported.

No sound is coming from the subwoofer

● **The playback source does not contain subwoofer channel signals or low-frequency signals.**

Try to play content containing subwoofer channel signals or low-frequency signals, to check if any sound can be heard from the subwoofer.

● **The volume of the subwoofer is too low.**

Turn up the volume of the subwoofer.

● **The power cord of the subwoofer is not connected to an AC wall outlet.**

Connect the power cord of the subwoofer to an AC wall outlet.

● **The protection circuit has been activated (the power light on the back of the subwoofer flashes red rapidly).**

To protect the product, the power of the subwoofer cannot be turned on. The protection circuit may also be activated by continuous loud playback, unplugging the unit during playback, or after a brief power failure. Make sure the power indicator is off before plugging the subwoofer power cord back in to turn on the sound bar again. If the power indicator still flashes rapidly, unplug the power cord from the AC wall outlet and contact the nearest authorized Yamaha dealer or service center.

● **Weak wireless signal (The CONNECT indicator on the rear of the subwoofer is flashing slowly).**

The condition of the wireless connection is bad, and the subwoofer cannot be connected to the sound bar. Try the following.

- Place the subwoofer closer to the sound bar.
- If metal furniture is placed between the sound bar and subwoofer, change the layout or relocate the subwoofer.
- If a device emitting electromagnetic waves (such as a microwave oven or a wireless LAN device) is located nearby, place the subwoofer and sound bar farther away from it.

● **The subwoofer and the sound bar are not connected (The CONNECT indicator on the rear of the subwoofer is flashing slowly. Or the CONNECT indicator is slowly flashing red).**

Manually connect the subwoofer to the sound bar.

- “Connecting a subwoofer manually” (p.198)

● **The subwoofer is not turned on.**

If the  icon appears on the soundbar front display and the subwoofer power indicator is solid red, the subwoofer has been turned off for some reason.

Unplug the power cord of the subwoofer from the AC wall outlet. Then wait until the power indicator goes off before plugging it in again.

The volume decreases or increases when the sound bar is turned back on

- **The default volume is set.**

In the Setup menu, it is possible that “Initial Volume” is “On”, and it is set to “Mute” or a low volume or to a high volume. Set it to “Off” or adjust the volume.

- “Making audio settings” (p.118)

No surround effect

● **Stereo playback is selected.**

Press SURROUND:AI, 3D MUSIC or STRAIGHT keys on the sound bar remote control to switch to surround playback.

● **The volume is too low.**

Turn up the volume.

● **The TV or AV device is set to output 2-channel audio (such as PCM) only.**

Change the audio output setting on the TV or AV device to output Bitstream audio signals.

● **Sound is also heard from the TV's built-in speakers.**

Turn the TV's volume all the way down.

● **You are listening from a position that's extremely close to the sound bar.**

You should listen at some distance from the sound bar.

● **The sound mode is switched to 3D MUSIC.**

In the Setup menu, when the "Sound" > "3D MUSIC Upmixer" screen is displayed, the sound mode automatically switches to 3D MUSIC. Switch the sound mode to suit the type of content.

- "Selecting music of your choice (Sound mode)" (p.96)

● **TRUE X SURROUND is set but no wireless speakers are connected.**

Check that wireless speakers are connected.

- "Checking the connection status of the wireless speakers on the sound bar" (p.82)

Noise is heard

- **The sound bar is too close to another digital or high-frequency device.**

Move those devices away from the sound bar.

Bluetooth® connection

The sound bar cannot be connected to a Bluetooth® device

- **Something other than Bluetooth is selected during input from a Bluetooth device.**
Set input to “Bluetooth” to playback content from a Bluetooth device on the sound bar.
- **When playing audio from the sound bar with a Bluetooth device, the sound bar input is set to Bluetooth.**
Set sound bar input to something other than “Bluetooth” to play back sound bar audio on a Bluetooth device.
- **The sound bar is too far away from the Bluetooth device.**
Move the Bluetooth device closer to the sound bar.
- **A device emitting electromagnetic waves (such as a microwave oven or a wireless device) is located nearby.**
Do not use the sound bar near devices that emit electromagnetic waves.
- **The Bluetooth device you are using does not support the A2DP profile.**
Use a Bluetooth device that supports the A2DP profile.
- **The connection profile registered in the Bluetooth device is not functioning correctly.**
Delete the connection profile in the Bluetooth device, and then connect the Bluetooth device to the sound bar.
- **The passkey for devices such as a Bluetooth adapter is not “0000”.**
Use a Bluetooth device with a passkey of “0000”.
- **The sound bar is connected to another Bluetooth device.**
Terminate the current Bluetooth connection, and then connect to the new device.
- **The Bluetooth function of the sound bar is disabled.**
Enable the Bluetooth function.

No sound can be heard or the sound cuts off intermittently from a Bluetooth® device

- **The volume on the Bluetooth device is too low.**
Raise the volume on the Bluetooth device.
- **Playback is not being performed on the Bluetooth device.**
Perform playback on the Bluetooth device.
- **The audio output destination on the Bluetooth device is not set to the sound bar.**
Select the sound bar as the audio output destination on the Bluetooth device.
- **The connection to the Bluetooth device was terminated.**
Connect to the Bluetooth device again.
- **The sound bar is too far away from the Bluetooth device.**
Move the Bluetooth device near the sound bar.
- **A device emitting electromagnetic waves (such as a microwave oven or a wireless device) is located nearby.**
Do not use the sound bar near devices that emit electromagnetic waves.

Network

Network functions cannot be used

- **The network information (IP address) is not being properly acquired.**
Enable the DHCP server function on the router.
- **You are trying to connect to an IPv6-type router.**
The sound bar does not support IPv6 networks. Connect the sound bar to an IPv4 network.

The sound bar cannot be connected to the Internet via a wireless LAN router (access point)

- **The wireless LAN router (access point) is off.**

Turn on the wireless LAN router (access point).

- **The sound bar is too far away from the wireless LAN router (access point).**

Install the sound bar and wireless LAN router (access point) closer to each other.

- **Obstacles are between the sound bar and wireless LAN router (access point).**

Install the sound bar and wireless LAN router (access point) in a place where there are no obstacles between them.

- **The wireless LAN router (access point) is set to use a specific wireless channel.**

Change the settings of the wireless LAN router so that it automatically selects a channel. If you want to specify the channel to use, specify channel 1 or 11.

A wireless network cannot be not found

- **Electromagnetic waves being emitted from devices such as microwave ovens or from other wireless devices are obstructing the wireless communication.**

Turn off these devices or keep the sound bar and wireless LAN router (access point) away from these devices. Or, connect the sound bar to a 5 GHz-compatible wireless LAN router (access point).

- **Access to the network is limited by the way the firewall is configured on the wireless LAN router (access point).**

Check to see how the firewall is configured on the wireless LAN router (access point).

Audio cannot be played with AirPlay

- **An audio file not supported by the sound bar is being played.**

Play the file on an AirPlay-compatible device, to see if it can be played back. If it cannot be played, the file format may not be supported, or the file may be corrupted.

The sound bar is not detected on an AirPlay-compatible device

- **The sound bar and an AirPlay-compatible device are each connected to different SSIDs.**

Connect the sound bar and AirPlay-compatible devices to the same SSID (try connecting them to the primary SSID).

Streaming services cannot be played

- **The selected streaming service is currently stopped.**

Try playing the streaming service again later.

- **Access to the network is limited by the way the firewall is configured on the router or other network device.**

Check to see how the firewall is configured on the network device. Also, streaming services can only be played via the port specified by each service. The port number varies depending on the streaming service.

- **This product is being used in an area where streaming services are not provided.**

Streaming services are only provided in certain areas. Streaming services may not be available in some countries or regions where the product is used.

An audio file on the media server (NAS, etc.) cannot be played

● **You are trying to play an audio file in a file format not supported by the sound bar.**

Only audio files in file formats supported by the sound bar can be played.

- “Supported digital audio signal formats” (p.190)

Notification of a firmware update is not displayed

● Notification of a firmware update is not displayed in the TV screen menu, front display, or MusicCast Controller.

If there is firmware update information for this product on the Yamaha website, but nothing appears in the TV screen menu, front display, or MusicCast Controller notification, please update the firmware via the USB port.

- “Updating the firmware with a USB flash drive” (p.143)

Use of the app

The app cannot detect the sound bar

● **An app not supported by the sound bar is being used.**

This product supports only the MusicCast Controller. Sound Bar Remote, HomeTheater Controller and Sound Bar Controller cannot be used.

● **The sound bar and smartphone are not connected to the same network.**

Check the network connection and the router's settings, and connect the sound bar and smartphone to the same network.

● **The smartphone is not connected wirelessly (via Wi-Fi) to the wireless LAN router.**

Connect the smartphone wirelessly (via Wi-Fi) to the wireless LAN router.

● **A router that supports multiple SSIDs is being used.**

The network splitting function of a wireless LAN router may prevent access to the sound bar. Connect the sound bar and smartphone to a network with the same SSID. Try connecting to the primary SSID first.

● **The wireless (Wi-Fi) function of the sound bar is disabled.**

If you are connected wirelessly (Wi-Fi) to a network, turn on the wireless (WiFi) function.

- “Setting up a network” (p.127)

● **The LAN cable is not connected**

If you have a wired connection to the network, make sure the LAN cable is securely connected.

- “Connecting to a network using a LAN cable (wired connection)” (p.43)

A media server (NAS, etc.) is not detected with the app

- **The media sharing setting on the media server is not enabled.**

The media sharing setting on each media server (NAS, etc.) or media server software must be enabled. See the documentation supplied with each device or software for more information.

- **Access to the media server is restricted due to settings such as security software.**

Check the security software settings of the media server or router.

TRUE X SURROUND

No sound is coming from both of the wireless speakers

- **The wireless speaker is not turned on.**

Check that the power indicator on the top of the wireless speaker is glowing. If the indicator is not glowing, hold down the power button on the wireless speaker to turn it on.

- **The mode is not set to SURROUND on the wireless speaker.**

Check that the SURROUND indicator on the top of the wireless speaker is glowing. If the SOLO indicator is glowing or flashing, press the  (mode) button to switch the mode to SURROUND.

If SURROUND cannot be selected by pressing  (mode) on the wireless speakers, it is possible that the registration of the wireless speakers to the sound bar has not been completed. In this case, complete the registration.

- “Registering wireless speakers to the sound bar” (p.60)

- **Audio output from the sound bar is not played in surround.**

Press the SURROUND:AI, 3D MUSIC or STRAIGHT keys on the sound bar remote control to switch to surround playback.

- **The volumes of the wireless speakers are set too low.**

Press the SURROUND L (+/-) or SURROUND R (+/-) keys on the sound bar remote control to adjust the volume of each wireless speaker. Point the remote control at the sound bar to operate it.

- **The content being played does not contain surround channel audio.**

Change the playback content to something that definitely contains surround channel audio, such as a movie that contains multi-channel audio, and check that audio is output from the wireless speakers.

- **The firmware of the wireless speakers is being updated.**

If the L and R indicators on the rears of the wireless speakers are glowing alternately, their firmware is being updated. Wait while the update is processing, and do not operate the buttons of the wireless speaker until the update is completed.

- **The condition of the connection between the sound bar and wireless speakers is bad.**

Check that there is no device emitting strong radio waves or interrupting radio waves placed between the sound bar and wireless speakers.

- **The registration of the wireless speakers was removed from the sound bar.**

If the SURROUND indicators on the tops of the wireless speakers keep flashing slowly, the registration of the wireless speakers to the sound bar may have been removed. Register the wireless speakers to the sound bar again.

- “Registering wireless speakers to the sound bar” (p.60)

- **One wireless speaker is turned off when not in ALL mode.**

When two wireless speakers are connected, if one of the wireless speakers is turned off or placed at a distance where it cannot be connected, no sound will come out of the wireless speakers except in ALL mode. Turn on both wireless speakers or move the wireless speakers closer to each other until they can be connected.

No sound is coming from one of the wireless speakers

If sound is coming from one of the wireless speakers and no sound is coming from the other wireless speaker, the following could be the cause.

● **In ALL mode, the wireless speaker may not be turned on.**

Check that the power indicator on the top of the wireless speaker is glowing. If the indicator is not glowing, hold down the power button to turn on the wireless speaker.

● **In ALL mode, the wireless speaker may not be set SURROUND mode.**

Check that the SURROUND indicator on the top of the wireless speaker is glowing. If the SOLO indicator is glowing or flashing, press \odot (mode) to switch the mode to SURROUND.

If SURROUND cannot be selected by pressing \odot (mode) on the wireless speakers, it is possible that the registration of the wireless speakers to the sound bar is not completed. In this case, complete the registration.

- “Registering wireless speakers to the sound bar” (p.60)

● **The volumes of the wireless speakers are set too low.**

Press the volume (+) buttons on the wireless speakers to turn up their volume.

Press the SURROUND L (+/-) or SURROUND R (+/-) keys on the sound bar’s remote control to adjust the respective volumes of the wireless speakers.

● **The firmware of the wireless speakers is being updated.**

If the L and R indicators on the rears of the wireless speakers are glowing alternately, their firmware is being updated. Wait while the update is processing, and do not operate the buttons of the wireless speaker until the update is completed.

● **The condition of the connection between the sound bar and wireless speakers is bad.**

Check that there is no device emitting strong radio waves or interrupting radio waves placed between the sound bar and wireless speakers.

● **The registration of the wireless speakers was removed.**

If SURROUND cannot be selected by pressing \odot (mode) on the wireless speakers, the registration of the wireless speakers to the sound bar may have been removed. In this case, complete the registration.

- “Registering wireless speakers to the sound bar” (p.60)

The volume of the connected wireless speakers is too low

If the volume of the wireless speakers is too low, the following could be the cause.

- **The volumes of the wireless speakers are set too low.**

Press the SURROUND L (+/-) or SURROUND R (+/-) keys on the sound bar remote control to adjust the volume of each of the wireless speakers. Point the remote control at the sound bar to operate it.

The wireless speakers do not turn on when the sound bar is turned on

If the wireless speakers do not turn on, the following could be the cause.

● **The wireless speakers are not connected to power.**

If the wireless speakers are not connected to power, the wireless speakers do not turn on automatically even when the sound bar is turned on. In this case, press the power buttons on both of the wireless speakers to turn them on.

● **The wireless speakers were turned off in SOLO mode.**

If the mode was set to SOLO when the wireless speakers were turned off, the wireless speakers do not turn on automatically even if the wireless speakers are connected to power. Choose SURROUND mode, and then turn off the wireless speakers.

● **The remaining battery level of the wireless speakers is low.**

Connect the wireless speakers to power to charge them before use. For details, refer to the User Guide of the wireless speakers.

● **Connecting the wireless speakers is time-consuming.**

If “True X Ready” is set to “Off”, it may take some time for the wireless speakers to turn on after the sound bar is turned on. To shorten the time, set “True X Ready” to “On”. The “On” setting consumes more power than the “Off” setting.

- “Setting up detailed function settings (Function)” (p.124)

The registration of the wireless speakers does not complete

If the registration of the wireless speakers will not complete and the wireless speakers cannot be connected to the sound bar, perform the following procedure to check the status.

● **You are trying to register a wireless speaker to the same channel as a wireless speaker that is already connected.**

Turn off the sound bar and wireless speakers and turn them back on. Then, start over the registration procedure again.

- “Registering wireless speakers to the sound bar” (p.60)

● **The wireless speaker’s registration wait status is canceled, and the mode is set to SOLO.**

If more than two minutes pass after the wireless speakers enter the registration wait status, the registration wait status is canceled, and the mode switches back to SOLO. Start over the registration procedure again.

- “Registering wireless speakers to the sound bar” (p.60)

● **The wireless speakers or sound bar have not entered the registration wait status.**

In the sound bar’s Setup menu, under “Speaker” > “Registration”, select “Registration”. When the “Registration” screen appears, follow the instructions on the screen to register the wireless speakers to the sound bar.

If the SURROUND indicators of the wireless speakers are not flashing, press  (mode) for at least three seconds.



If the registration still does not complete with the above operation, wait until the indicators on the front of the sound bar return to their normal display and the SOLO indicators on the wireless speakers either flash or glow, and then start over the registration procedure again.

- “Registering wireless speakers to the sound bar” (p.60)

L/R cannot be selected while the wireless speakers are being registered

If you cannot select L/R while registering the wireless speakers, it could be because of the following.

● **The wireless speakers are waiting to be registered to the sound bar.**

Since  (mode) on the wireless speaker was held down two times consecutively, the wireless speaker is waiting to be registered to the sound bar. Hold down  (mode) until the SURROUND indicator turns off, and then select L/R again.

● **The mode is set to SOLO on the wireless speakers.**

Start over the registration procedure again.

● **The wireless speakers are off.**

Turn on the wireless speakers and register them. If the remaining battery level of the wireless speakers is low, charge the wireless speakers, and then turn them on. For details on charging, refer to the User Guide of the wireless speakers.

Related links

[“Registering wireless speakers to the sound bar” \(p.60\)](#)

Audio content from a Bluetooth device cannot be played on the wireless speakers

If audio content from a Bluetooth device cannot be played on the wireless speaker after the wireless speaker have been registered to the sound bar, the following could be the cause.

- **The mode is not set to SOLO on the wireless speaker.**

Check that the SOLO indicator on the top of the wireless speaker is glowing. If the SURROUND indicator is glowing or flashing, press  (mode) to switch the mode to SOLO.

NOTE

For causes other than the above, refer to the User Guide of the wireless speakers.

Broken, distorted, or unusual sounds are heard

If the sound quality of the wireless speakers is deteriorated significantly, the following could be the cause.

● **The volume is too high.**

Point the sound bar remote control at the sound bar and press the SURROUND L (+/-) or SURROUND R (+/-) keys on the sound bar remote control to adjust the volume of each of the wireless speakers.

● **The condition of the connection between the sound bar and wireless speakers is bad.**

Check that there is no device emitting strong radio waves or interrupting radio waves placed between the sound bar and wireless speakers. Install the wireless speakers within 10 m (33 ft) of the sound bar.

The sound bar and subwoofer are not connected automatically

- **A temporary communications failure may have occurred.**

Normally, the sound bar and subwoofer are paired and connected automatically, but if they are not properly paired due to a temporary communications failure, connect them manually.

- **The soundbar was initialized or the subwoofer registration was canceled.**

Once the subwoofer is registered, the subwoofer will not automatically connect if the soundbar is initialized or speaker registration is canceled. Connect the devices manually.

Related links

[“Connecting a subwoofer manually” \(p.198\)](#)

How to initialize (reset)/restart the sound bar

To initialize (reset) the sound bar

Refer to the following instructions to reset the settings.

■ To operate the Setup menu (tv screen)

- 1 Press the  (Setup) key.**
- 2 Select “Function” > “Initialization” > “All” from the “Setup” menu.**
- 3 Follow the instructions on the screen.**

When initialized, the sound bar restarts automatically.

When “Network” is selected, a message indicating that initialization has been completed appears, but the sound bar is not restarted.

This completes the settings.

■ Using the front display menu

- 1 Press the  (Front Display Menu) key.**
- 2 Select “Initialization” > “All Initialization” from the front display menu.**

When initialized, the sound bar restarts automatically.

When “Network Initialization” is selected, a message indicating that initialization has been completed appears, but the sound bar is not restarted.

This completes the settings.

Force the sound bar to restart

Press the power button on the sound bar for at least 10 seconds. Restart the sound bar.

“Internal Error” appears on the front display

● **A malfunction has occurred in the sound bar**

Press the power button on the sound bar for at least 10 seconds to force the sound bar to turn off.

Disconnect the power cord of the subwoofer from the AC wall outlet. Make sure the power indicator is off before plugging the power cord of the subwoofer back in and turn on the sound bar again.

If these procedures do not help, contact the nearest authorized Yamaha dealer or service center.

SPECIFICATIONS

Specifications

The specifications of this product are as follows.

■ Sound bar

Amplifier section (Maximum rated output power)

Front L/R	100 W × 2
Center	100 W
Height L/R	2.5 W × 12

Speaker section

Front L/R

- Type Enclosed type (non-magnetic shielding)
- Driver 11 × 5.3 cm (4 3/8" × 2 1/8") cone × 2
- Frequency response 120 Hz to 3.2 kHz
- Impedance 6 Ω

- Type Enclosed type (magnetic shielding)
- Driver 2.5 cm (1") dome × 2
- Frequency response 3.2 kHz to 20 kHz
- Impedance 6 Ω

Center

- Type Enclosed type (non-magnetic shielding)
- Driver 11 × 5.3 cm (4 3/8" × 2 1/8") cone × 2
- Frequency response 120 Hz to 3.2 kHz
- Impedance 12 Ω (parallel 6 Ω)

- Type Enclosed type (magnetic shielding)
- Driver 2.5 cm (1") dome × 1
- Frequency response 3.2 kHz to 20 kHz
- Impedance 6 Ω

Height	
• Type	Enclosed type (magnetic shielding)
• Driver	2.8 cm (1 1/8") cone × 12
• Frequency response	500 Hz to 20 kHz
• Impedance	4 Ω

Input jacks

Digital optical	1 (OPTICAL)
HDMI	1 (HDMI IN)

Output jacks

HDMI	1 (HDMI OUT/TV (eARC))
------	------------------------

Other jacks

USB	1 (UPDATE ONLY)
Network (100BASE-TX/10BASE-T)	1 (NETWORK)

Bluetooth

Sink Function	Receiving signals from a Bluetooth device (such as a smartphone or tablet)
Source Function	Transmitting signals to a Bluetooth device (such as Bluetooth headphones)
Bluetooth version	Ver. 4.2
Supported profiles	Sink function: A2DP, AVRCP Source function: A2DP, AVRCP
Supported codecs	Sink function: SBC, AAC Source function: SBC
Bluetooth class	Bluetooth Class 1
Range (with line-of-sight)	Approx. 10 m (33 ft) (without obstructions)
Supported content protection methods	SCMS-T method (when receiving)

Wireless network

- Wireless LAN standards IEEE802.11 a/b/g/n/ac*
*20 MHz channel bandwidth only
- Radio frequency bands 2.4 GHz/5 GHz
- Maximum communication distance Approx. 10m (33 ft) (without obstructions)
- Available security methods WPA, WPA2

Network audio function

Supported codecs WAV (PCM format only)/FLAC/AIFF/Ogg Vorbis: up to 384 kHz
ALAC: up to 96 kHz
MP3/WMA/Ogg Opus: up to 48 kHz

General

Power supply

- Models for U.S.A., Canada AC 100 to 120 V, 50/60 Hz
- Models for U.K., Europe, China and other areas AC 220 to 240 V, 50/60 Hz

Power consumption 54 W

Standby power consumption

- HDMI Control, Pass Through, Network Standby (wired, wireless), Bluetooth: Off 0.5 W
- HDMI Control, Pass Through: On
Network Standby (wired, wireless), Bluetooth: Off 2.0 W
- HDMI Control, Pass Through, Network Standby (wireless), Bluetooth: Off
Network Standby (wired): On 2.0 W
- HDMI Control, Pass Through, Network Standby (wired), Bluetooth: Off
Network Standby (wireless): On 2.0 W
- HDMI Control, Pass Through, Network Standby (wired, wireless): Off
Bluetooth: On 2.0 W

Dimensions (W × H × D)

- Installed in front of a TV, etc. 1180 × 85 × 143 mm (46 1/2" × 3 3/8" × 5 5/8")
- Mounted on a wall, including the mounting brackets 1180 × 76 × 155 mm (46 1/2" × 3" × 6 1/8")

Weight 11 kg (24.3 lbs)

■ Subwoofer

Amplifier section

Maximum rated output power 100 W

Speaker section

- Type Bass reflex type (non-magnetic shielding)
- Driver 17 cm (6 3/4") cone × 1
- Frequency response 33 Hz to 120 Hz
- Impedance 3 Ω

Communication between the sound bar and subwoofer

- Radio frequency band 5 GHz
- Maximum communication distance Approx. 10 m (33 ft) (without obstructions)

General

Power supply

- Models for U.S.A., Canada AC 100 to 120 V, 50/60 Hz
- Models for U.K., Europe, China and other areas AC 220 to 240 V, 50/60 Hz

Power consumption

24 W

Standby power consumption

2.0 W

Dimensions (W × H × D)

241 × 378 × 414 mm (9 1/2" × 14 7/8" × 16 1/4")

Weight

12.7 kg (28.0 lbs)

NOTE

The contents of this User Guide apply to the latest specifications as of the publishing date. The latest version of the User Guide is available to download from the Yamaha website.

Supported HDMI video signal formats

The following HDMI video signals are supported by this product.

The following video signals are supported.

- Deep Color
- x.v.Color
- 3D video signals
- High Dynamic Range (HDR) video signals
- HDR10
- HLG
- Dolby Vision
- HDR10+

The following resolutions are supported.

- VGA
- 480i / 60 Hz
- 480p / 60 Hz
- 576i / 50 Hz
- 576p / 50 Hz
- 720p / 60 Hz, 50 Hz
- 1080i / 60 Hz, 50 Hz
- 1080p / 120 Hz, 100 Hz, 60 Hz, 50 Hz, 24 Hz
- 4K / 60 Hz, 50 Hz, 30 Hz, 25 Hz, 24 Hz

The following feature is supported.

- ALLM (Auto Low Latency Mode)

■ Copyright protection standards

HDCP 2.3, HDCP1.4

NOTE

- See also the instruction manual supplied with the AV device for details on how to connect it to the sound bar.
- Some DVD players may not play back audio or video signals when playing a copy-protected DVD.
- The sound bar does not support TVs or projectors equipped with HDMI or DVI jacks that are not HDCP compatible. See the instruction manual supplied with the HDMI or DVI device to check whether it is HDCP-compatible.
- The resolution at which video signals are transmitted varies depending on the specifications of the connected TV.
- The contents of this User Guide apply to the latest specifications as of the publishing date. The latest version of the User Guide is available to download from the Yamaha website.

Supported digital audio signal formats

The following digital audio signals are supported by this product.

■ Audio input signals of the HDMI IN jack

The following audio signals can be played on this product when they are input from the HDMI output jack on an AV device to the HDMI IN jack on the sound bar:

Audio formats	Details
2-channel Linear PCM	2ch, 32 / 44.1 / 88.2 / 96 / 176.4 / 192 kHz, 16 / 20 / 24 bit
Multi-channel PCM	8ch, 32 / 44.1 / 88.2 / 96 / 176.4 / 192 kHz, 16 / 20 / 24 bit
Bitstream	Dolby Digital / Dolby Digital Plus / Dolby TrueHD / Dolby Atmos - Dolby Digital Plus / Dolby Atmos - Dolby TrueHD / DTS 96/24 / DTS-ES Discrete 6.1 / DTS-ES Matrix 6.1 / DTS / DTS Express / DTS-HD High Resolution / DTS-HD Master Audio / DTS:X / AURO-3D

■ Audio input signals of the HDMI OUT/TV (eARC) jack

The following digital audio signals can be played on this product when they are input from the ARC-compatible HDMI input jack on the TV to the HDMI OUT/TV (eARC) jack on the sound bar:

Signals from a TV's eARC-compatible HDMI input jack

Audio formats	Details
2-channel Linear PCM	2ch, 32 / 44.1 / 88.2 / 96 / 176.4 / 192 kHz, 16 / 20 / 24 bit
Multi-channel PCM	8ch, 32 / 44.1 / 88.2 / 96 / 176.4 / 192 kHz, 16 / 20 / 24 bit
Bitstream	Dolby Digital / Dolby Digital Plus / Dolby TrueHD / Dolby Atmos - Dolby Digital Plus / Dolby Atmos - Dolby TrueHD / DTS 96/24 / DTS-ES Discrete 6.1 / DTS-ES Matrix 6.1 / DTS / DTS Express / DTS-HD High Resolution / DTS-HD Master Audio / DTS:X / AURO-3D

Signals from a TV's ARC-compatible HDMI input jack

Audio formats	Details
2-channel Linear PCM	2ch, 32 / 44.1 / 88.2 / 96 / 176.4 / 192 kHz, 16 / 20 / 24 bit
Bitstream	Dolby Digital / Dolby Digital Plus / Dolby Atmos - Dolby Digital Plus / DTS 96/24 / DTS-ES Discrete 6.1 / DTS-ES Matrix 6.1 / DTS

■ Audio input signals of the OPTICAL jack

The following digital audio signals can be played on this product when they are input from the digital optical output jack on the TV to the OPTICAL jack on the sound bar:

Audio formats	Details
2-channel Linear PCM	2ch, 32 / 44.1 / 88.2 / 96 kHz, 16 / 20 / 24 bit
Bitstream	Dolby Digital / DTS / DTS 96/24 / DTS-ES Discrete 6.1 / DTS-ES Matrix 6.1

NOTE

- The contents of this User Guide apply to the latest specifications as of the publishing date. The latest version of the User Guide is available to download from the Yamaha website.
- See also the instruction manual supplied with the AV device for details on how to connect it to the sound bar.
- Some DVD players may not play back audio or video signals when playing a copy-protected DVD.
- The sound bar does not support TVs or projectors equipped with HDMI or DVI jacks that are not HDCP compatible. See the instruction manual supplied with the HDMI or DVI device to check whether it is HDCP-compatible.
- To decode Bitstream audio signals, change the settings on the AV device so that the AV device directly outputs Bitstream signals. See the instruction manual supplied with the AV device for more information.
- Playback of DVD-Audio and SACD is not supported.

APPENDIX

Making a wireless connection to a network

Selecting a wireless connection method to a network

Once the soundbar is registered to the MusicCast network, the wireless (Wi-Fi) settings can be made at the same time using MusicCast Controller.

If you are not using a MusicCast Controller, select the connection method that suits your network environment.

- 1 Press the  (Setup) key on the remote control.**
- 2 Select “Network”.**
- 3 Select “Network Connection”.**
- 4 Select “Wireless(Wi-Fi)”.**

Use the link below to select a wireless connection method.

NOTE

It may not be possible to connect the sound bar to a wireless LAN router (an access point) if they are far apart. In such a case, install the sound bar and wireless LAN router (access point) close to each other.

Related links

- “Registering to a MusicCast network” (p.56)
- “Using the WPS button to make wireless connections” (p.193)
- “Using iPhone to make wireless connections” (p.194)
- “Connecting wirelessly from a list of access points” (p.195)
- “Making a wireless connection manually” (p.196)
- “Wireless connection with PIN-code type WPS” (p.197)

Using the WPS button to make wireless connections

Press the WPS button on a wireless LAN router to easily make a wireless connection.

Setup menu

“Network” > “Network Connection” > “Wireless(Wi-Fi)”

1 Select the “WPS Button”.

2 Follow the instructions on the TV screen to make a wireless connection.

When the connection is completed, “Completed” will be displayed.

If the message “Not connected” is displayed, start over from step 1 or try a different connection method.

This completes the wireless connection.

NOTE

Cannot connect to wireless LAN routers that use WEP as the encryption method. If so, try another connection method.

■ What is WPS?

WPS (Wi-Fi protected setup) is a Wi-Fi Alliance standard. WPS makes it easy to configure a wireless network.

Using iPhone to make wireless connections

Use your iPhone network setting for your sound bar to make a wireless setting.

Before starting the settings, confirm that your iPhone is connected to your wireless LAN router.

NOTE

You need an iPhone using iOS7 or later.

Setup menu

“Network” > “Network Connection” > “Wireless(Wi-Fi)”

1 Select “WAC(iOS)”.

2 Follow the instructions on the TV screen to make a wireless connection.

Once the sharing operation is complete, the sound bar will automatically connect to the selected wireless LAN router.

This completes the wireless connection.

NOTE

- The settings of the sound bar are initialized.
 - Network
 - Bluetooth
 - Content registered to Favorites in MusicCast Controller
 - NET RADIO radio stations you have added to your Favorites
 - Account information for each music service
- Cannot connect to wireless LAN routers that use WEP as the encryption method. If so, try another connection method.
- If a network cable is connected to the sound bar, a warning message will appear. Disconnect the network cable before operating.

Connecting wirelessly from a list of access points

Select a connection point from the list of wireless LAN routers searched by the soundbar and set up a wireless connection.

A security key must be set manually.

Setup menu

“Network” > “Network Connection” > “Wireless(Wi-Fi)”

1 Select “Access Point Scan”.

2 Follow the instructions on the TV screen to make a wireless connection.

When the connection is completed, “Completed” will be displayed.

If the message “Not connected” is displayed, start over from step 1 or try a different connection method.

This completes the wireless connection.

Making a wireless connection manually

Enter the required information to make a wireless connection. You may have to manually enter SSID (network name), encryption method and security key.

Setup menu

“Network” > “Network Connection” > “Wireless(Wi-Fi)”

1 Select “Manual Setting”.

2 Follow the instructions on the TV screen to make a wireless connection.

When the connection is completed, “Completed” will be displayed.

If you receive a “Not connected” message, please try again or try a different connection method.

This completes the wireless connection.

Wireless connection with PIN-code type WPS

Enter the PIN code on a wireless LAN router to make a wireless connection. This service is available when the wireless LAN router supports PIN code type WPS.

Setup menu

“Network” > “Network Connection” > “Wireless(Wi-Fi)”

1 Select “PIN Code”.

2 Follow the instructions on the TV screen to make a wireless connection.

When the connection is completed, “Completed” will be displayed.

If the message “Not connected” is displayed, start over from step 1 or try a different connection method.

This completes the wireless connection.

Connecting a subwoofer manually

Manually connect the subwoofer to the sound bar as described below.

- 1 Hold down SETUP button on the rear of the subwoofer for at least five seconds.**
- 2 Turn on the sound bar.**
- 3 Press the  (Setup) key and select “Speaker” to select “Registration” in the “Registration” screen.**

When the connection is established, the CONNECT indicator on the rear of the subwoofer glows.

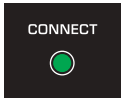

If the CONNECT indicator on the subwoofer does not glow after following the procedure above, do the following and then connect the subwoofer manually again.

- Move the subwoofer and/or the sound bar so that they are closer to each other.
- Install the sound bar and subwoofer in positions where they are not obstructed from each other by metal furniture.
- If a device emitting electromagnetic waves (such as a microwave oven or a wireless LAN device) is located nearby, place the subwoofer and sound bar farther away from such a device.

NOTE

- Check the connection status of the subwoofer with the indicators on the front display of the sound bar.



Glowing: Connected
Off: Not registered or not connected

- To disconnect the sound bar from the subwoofer, select “Clear” in the “Speaker” > “Registration” screen from the Setup menu. Selecting “Clear” will delete all speaker registrations made to the sound bar.

Related links

“Configuring the speakers” (p.115)

Trademarks

The following trademarks are used in this guide.

COMPATIBLE WITH



Dolby, Dolby Vision, Dolby Atmos, and the double-D symbol are trademarks of Dolby Laboratories Licensing Corporation. Manufactured under license from Dolby Laboratories.

Confidential unpublished works. Copyright © 2012–2024 Dolby Laboratories. All rights reserved.



FOR DTS PATENTS, SEE [HTTP://XPERI.COM/DTS-PATENTS/](http://XPERI.COM/DTS-PATENTS/).

MANUFACTURED UNDER LICENSE FROM DTS, INC. AND ITS AFFILIATES.

DTS, DTS:X, AND THE DTS:X LOGO ARE REGISTERED TRADEMARKS OR TRADEMARKS OF DTS, INC. AND ITS AFFILIATES IN THE UNITED STATES AND/OR OTHER COUNTRIES.

© DTS, INC. AND ITS AFFILIATES. ALL RIGHTS RESERVED.



AURO-3D® is a registered trademark of GOER DYNAMICS, BV. AURO, AURO-3D, Auro-Codec and Auro-Matic are trademarks of GOER DYNAMICS, BV.



To use AirPlay with Front Surround System, the latest version of iOS, iPadOS, or macOS is recommended.

Use of the Works with Apple AirPlay badge means that an accessory has been designed to work specifically with the technology identified in the badge and has been certified by the developer to meet Apple performance standards.

Apple, AirPlay, Apple TV, Apple Watch, iPad, iPad Air, iPad Pro, iPhone, Lightning, and iTunes are trademarks of Apple Inc., registered in the U.S. and other countries and regions.



The terms HDMI, HDMI High-Definition Multimedia Interface, HDMI Trade Dress and the HDMI Logos are trademarks or registered trademarks of HDMI Licensing Administrator, Inc.



The Bluetooth® word mark and logos are registered trademarks owned by Bluetooth SIG, Inc. and any use of such marks by Yamaha Corporation is under license. Other trademarks and trade names are those of their respective owners.



The Wi-Fi CERTIFIED™ Logo and Wi-Fi Protected Setup Logo are registered trademark of Wi-Fi Alliance®.

Wi-Fi, Wi-Fi CERTIFIED, Wi-Fi Protected Setup and WPA2 are trademarks or registered trademarks of Wi-Fi Alliance®.

x.v.Color™

“x.v.Color” is a trademark of Sony Corporation.

App Store

App Store is a service mark of Apple Inc., registered in the U.S. and other countries.

Android Google Play

Android and Google Play are trademarks of Google LLC.



MusicCast is a trademark or registered trademark of Yamaha Corporation.

Google Noto Fonts

This product uses the following fonts.

Copyright © June 2015, Google (<https://www.google.com/get/noto/#sans-lgc>), with Reserved Font Name Noto Sans.

Copyright © June 2015, Google (<https://www.google.com/get/noto/help/cjk/>), with Reserved Font Name Noto SansCJK.

This Font Software is licensed under the SIL Open Font License, Version 1.1. This license is available with a FAQ at: <http://scripts.sil.org/OFL>

GPL/LGPL

This product utilizes GPL/LGPL open-source software in some sections. You have the right to obtain, duplicate, modify, and redistribute this open-source code only. For information on GPL/LGPL open source software, how to obtain it, and the GPL/LGPL license, refer to the Yamaha Corporation website

(<https://download.yamaha.com/sourcecodes/musiccast/>).

Licenses

For information on the licenses of the third-party software in this product, refer to the following.

[http://\(IP address of this product*\)/licenses.html](http://(IP address of this product*)/licenses.html)

* IP address of this product is checked with MusicCast Controller, the Setup menu or front display menu.

List of support centers

If the trouble still cannot be solved, please contact us for product support as explained below:

For customers within Japan

Please contact the store where you purchased this product, or the Product Support Center as listed in the “Quick Guide” included with this product.

For customers outside of Japan

Please contact your nearest authorized Yamaha dealer or service center.

https://manual.yamaha.com/audio/address_list/

Yamaha Global Site
<https://www.yamaha.com/>

Yamaha Downloads
<https://download.yamaha.com/>

© 2025 Yamaha Corporation

Published 12/2025 NV-C0

AV24-0002