

RESIDENTIAL 9" TOUCHSCREEN CONSOLE

TRUE FITNESS



**MODEL C4RT9
MAN-C4RT9 REV03**

**OWNER'S
MANUAL**



IMPORTANT—PLEASE READ

All products shown are prototype. Actual product delivered may vary. Product specifications, features, and software are subject to change without notice.

For the most up-to-date version of this manual, please see our website:

<https://shop.truefitness.com/services-support/user-manuals/>

CONTACTING OUR SUPPORT TEAM

To contact TRUE for any of your pre or post installation questions, please call our toll-free numbers Monday - Friday 8:30am - 5:00pm (CST):

- Commercial Direct Customers and Corporate Accounts | 800.868.8783
- Retail Customers and Distributors | 800.883.8783

Or email us:

- Commercial Direct Customers and Corporate Accounts | service.direct@truefitness.com
- Retail Customers and Distributors | service@truefitness.com
- Service International | int.service@truefitness.com

When contacting TRUE, please have the following information ready:

- Serial Number of Unit
- Contact Information—Full Name, Email, and Phone Number
- Address of Facility or Residence
- Detailed Description Regarding Symptom of the Unit (along with pictures or video if applicable)

NOTE: Authorized service providers, dealers, and distributors may also use TRUE's online resource | portal.truefitness.com.

CONTACTING OUR SALES TEAM

Interested in owning more TRUE products? Please contact us with any product inquiries so that we may direct you to the appropriate sales representative to help answer your questions.

- Phone | 800.426.6570
- Email | sales@truefitness.com
- Hours | Monday - Friday 8:30am - 5:00pm (CST)

REPORTING FREIGHT CLAIMS OR PARTS DAMAGE

Unfortunately, sometimes materials can be damaged during shipment. If materials are damaged during shipment, please follow the guidelines below to determine the appropriate process for you to follow.

Severe Damage—Obvious damage to external packaging and internal product.

Please refuse the shipment and it will be returned to TRUE by the carrier. Contact TRUE product support by calling 800.883.8783 or sales support by calling 800.426.6570 Monday-Friday during normal business hours to notify us that the shipment has been refused. Once we have received the damaged shipment, a replacement shipment will be sent to you. If the shipment comes in multiple boxes, only refuse boxes with damage.

Slight Damage—Minimal damage to external packaging with unknown internal damage to product.

If the shipment has minimal damages and you are not sure if the actual product is damaged, you must sign the bill of lading as damaged when accepting the shipment. Once you have opened the box and you have determined something is indeed damaged, please gather the serial number, model number, description of damage, and photos of damage. Please make sure the photos include the damaged product as well as the damaged box the product arrived in. Contact TRUE product support (service@truefitness.com | 800.883.8783) or TRUE sales support (sales@truefitness.com | 800.426.6570) Monday-Friday during normal business hours.

Concealed Damage—No damage to external packaging but internal damage to product.

You may receive a shipment that looks intact and discover once the box has been opened that there are hidden damages. Please notify the carrier immediately. TRUE will not be able to file a claim if the carrier is not notified in a timely manner. Once you have called the carrier you will need to gather the serial number, model number, description of damage, and photos of damage. Contact TRUE product support (service@truefitness.com | 800.883.8783) or TRUE sales support (sales@truefitness.com | 800.426.6570) Monday-Friday during normal business hours.

TABLE OF CONTENTS

SAFETY INSTRUCTIONS

IMPORTANT SAFETY INSTRUCTIONS—SAVE THESE INSTRUCTIONS.....	5
POWER REQUIREMENTS.....	5
WARNING DECALS.....	6
COMPLIANCES.....	7

ASSEMBLY INSTRUCTIONS

PREASSEMBLY CHECKLIST.....	8
ASSEMBLY STEPS.....	9

CONSOLE FEATURES

FEATURES OVERVIEW.....	18
9" TOUCHSCREEN ICON DESCRIPTIONS.....	19
WORKOUT PROGRAM DESCRIPTIONS.....	20

HEART RATE INFORMATION

HEART RATE MONITORING.....	22
HEART RATE CONTROL (HRC).....	23

CONSOLE NAVIGATION

HOME SCREEN.....	24
SELECTING A PRESET WORKOUT.....	25
WORKOUT DATA SCREENS.....	26
USER PROFILES.....	29
BLUETOOTH FUNCTIONS.....	30
ADVANCED CONSOLE FUNCTIONS.....	33

WARRANTY INFORMATION

LIMITED WARRANTY.....	38
WARRANTY REGISTRATION	39

SAFETY INSTRUCTIONS

IMPORTANT SAFETY INSTRUCTIONS—SAVE THESE INSTRUCTIONS

This equipment intended for in-home use only. Do not use this product in any commercial, rental, school or institutional setting.

- Read and understand all instructions and warnings prior to use.
- Obtain a medical exam before beginning any exercise program. If at any time during exercise you feel faint, dizzy, or experience pain, stop and consult your physician.
- Obtain proper instruction prior to use.
- This unit is intended for in-home use only.
- Inspect the unit for incorrect, worn, or loose components and do not use until corrected, replaced, or tightened prior to use.
- Do not wear loose or dangling clothing while using the unit.
- Care should be used when mounting or dismounting the unit.
- Read, understand, and test the emergency stop procedures before use.
- Disconnect all power before servicing the unit.
- Keep the top side of the moving surface clean and dry.
- Keep children and animals away.
- Use caution when moving and assembling unit.
- All exercise equipment is potentially hazardous. If attention is not paid to the conditions of equipment usage, death, or serious injury could occur.

See the base owner's manual and assembly guide for additional product specific cautions and warnings.

POWER REQUIREMENTS

Read and understand all instructions before plugging any TRUE power cord into an electrical outlet.

GROUNDING INSTRUCTIONS

This product must be grounded. If the product malfunctions or breakdowns, grounding provides a path of least resistance for electric current to reduce the risk of electric shock. This product is equipped with a cord having an equipment grounding conductor and a grounding plug. The plug must be plugged into an appropriate outlet that is properly installed and grounded in accordance with all local codes and ordinances.

DANGER:

- Improper connection of the equipment grounding conductor can result in risk of electrical shock.
- Check with a qualified electrician or service provider if you are in doubt as to whether the equipment is properly grounded or installed on a dedicated line.
- Seek a qualified electrician to perform any modifications to the cord or plug. TRUE is not responsible for injuries or damages as a result of cord or plug modification.
- To reduce the risk of burns, fire, electric shock, or injury, it is imperative to connect each product to a properly grounded 110V or 220V electrical outlet. The voltage required for your unit is located on the serial number decal (usually on the front of the unit). Depending on where you live voltage requirements differ.
- Some TRUE products require a circuit rated 110V, 60 Hz, and 20 amps. In the United States, most residential homes have circuits rated 110V, 60 Hz, and 15 amps. If your unit requires a 20 amp outlet, contact an electrician to install a dedicated 20 amp circuit prior to use.
- **110 Volt**—This model is for use on a nominal 110V circuit and has a grounding plug that looks like the plug illustrated to the right. Make sure the product is connected to an outlet having the same configuration as the plug. No adapter should be used with this product.

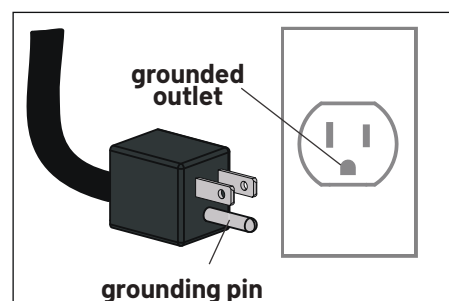

WARNING DECALS

⚠ WARNING: Replace warning labels that may be worn, damaged, or missing.

To replace any worn or missing decals contact TRUE product support (service@truefitness.com | 800.883.8783).

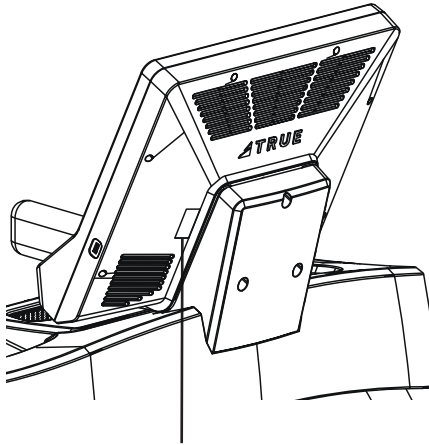

console serial
number location

24-000000X

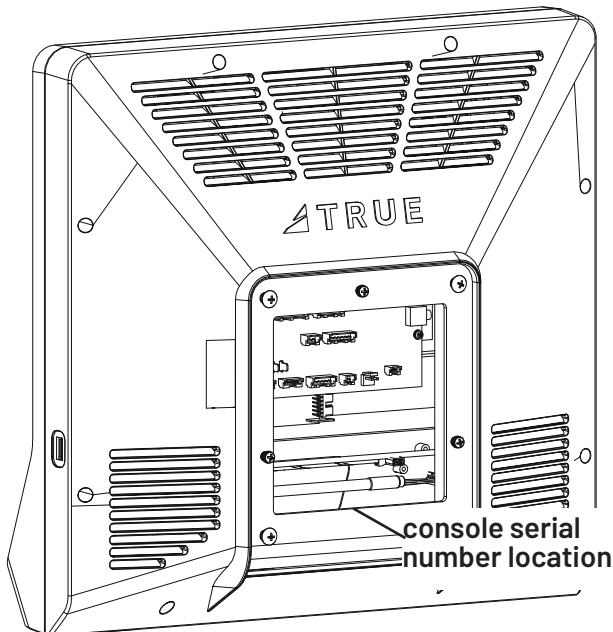

console serial
number location

S/N: 24-000000X

MDL: C4RT9

SAMPLE

WARNING DECALS



COMPLIANCES

This equipment complies with all applicable codes and regulations. For a complete list of compliances, please visit www.truefitness.com.

ASSEMBLY INSTRUCTIONS

 **NOTE:** Supplemental video available [@TRUEFitnessservicevids](https://www.truefitness.com/@TRUEFitnessservicevids).

PREASSEMBLY CHECKLIST

BASIC GUIDELINES FOR SETTING UP THE EQUIPMENT

After removing the equipment from the packaging, place the equipment on a clean, level surface. Make sure the electrical cord easily reaches a grounded three-pronged outlet.

⚠ DANGER: Do not use an extension cord or ungrounded outlet. The ground helps prevent electrical damage to your equipment and enhances your safety by helping to prevent shock. Check with a qualified electrician or serviceman if you are in doubt as to whether the equipment is properly grounded. Do not modify the plug provided with the unit if it will not fit the outlet. Have a proper outlet installed by a qualified electrician.

⚠ CAUTION:



Use caution when assembling the equipment.
Unpacking and assembling of this product is a two person task.



Use caution when unpacking this product. Avoid damage to the product.
DO NOT use a box cutter. DO NOT slice into the packaging.

VERIFY BOX CONTENTS

IMPORTANT! Please verify box contents. If you have questions, or if there are any missing parts, contact product support (service@truefitness.com | 800.883.8783).

BOX CONTENTS

ITEM	PART NUMBER	DESCRIPTION	QTY	TOOLS NEEDED FOR ASSEMBLY	INCLUDED IN BOX
1	C4RT9	CONSOLE, UCIV, RETAIL 9" TOUCHSCREEN	1	#2 Phillips Screwdriver 	NO
2	MAN-C4RT9	MANUAL, C4RT9	1		

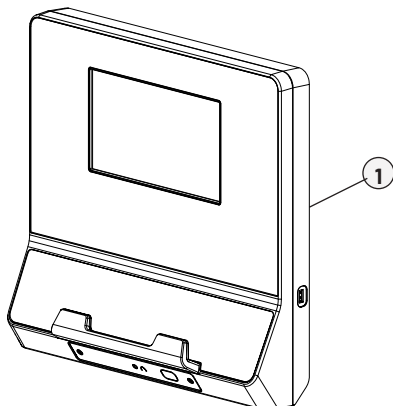

ASSEMBLY STEPS

Example shown below—see the base assembly instructions for how to attach the console to the console mast for your base.

Step 1—Attach Console to Mast

Tools Used in this Step	
#2 Phillips Screwdriver	

Parts Used in this Step			
Item	Part	Description	Qty
1	N/A	CONSOLE MAST ASSEMBLY	1
2	N/A	CONSOLE	1

Using a #2 Phillips screwdriver, secure the console to the console mast using the hardware preassembled to the console (00567800 // SCREW, M5-.8X12 COMBO PHILLIPS/Common TRUSS HEAD - ACG BLACK // QTY 4).

NOTE: If the console also has three screws (00567700 // SCREW, M4-.7 X 12 PPHMS SEMS // QTY 3) preassembled, remove and set aside these screws. They are not used in this installation.

NOTE: Loosen but do not remove the bottom two preassembled screws (00567800), those slide into the keyhole slots on the console mast.

NOTE: Ensure all cables are routed inside the console mast to avoid pinching the cables.

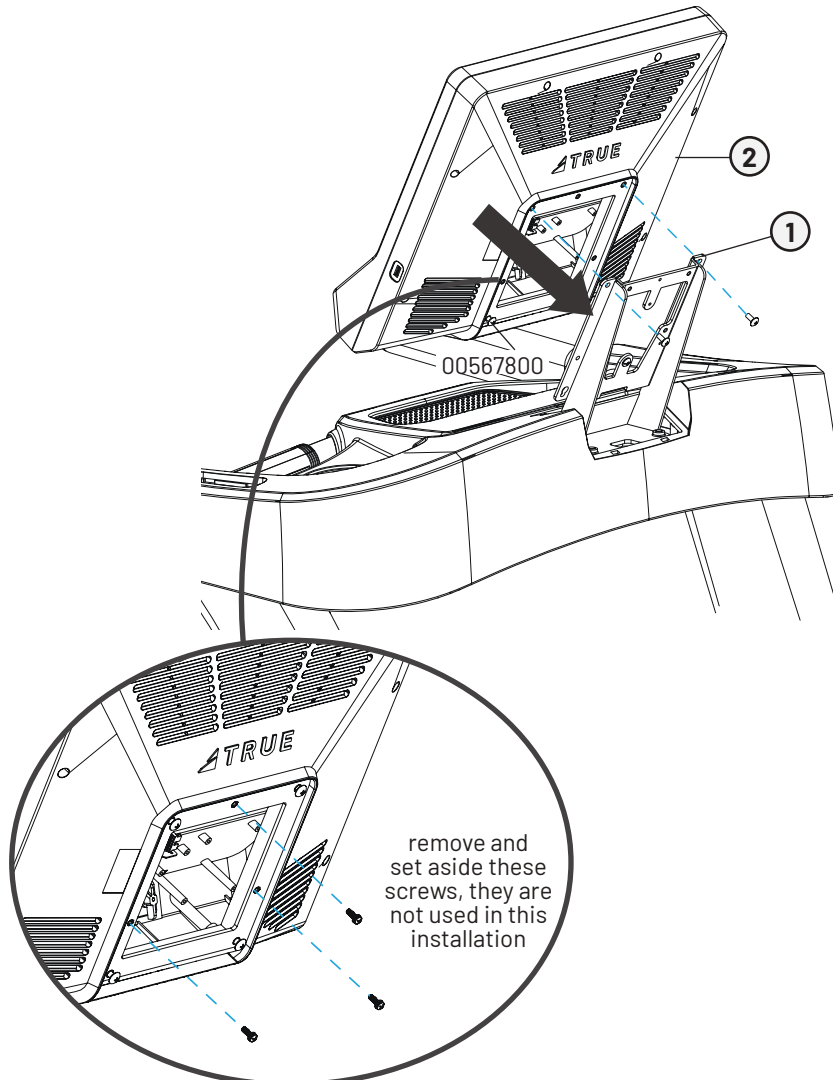

Step 2—Make Cable Connections

Example shown below—see the base assembly instructions for how to attach the console to the console mast for your base.

- A. Connect the I/O cable, center pod cable, contact heart rate cable, and safety key cable to their respective ports on the console control board.

NOTE: The longer safety key connector pictured below is only used for the touchscreen console. The shorter connector will not be used.

- B. Connect the ground wire ring terminal to the preinstalled, grounded screw on the console mast, ensuring the grounded screw secures the ground wire ring terminal to the front console mast. Ensure the ground wire ring is connected.

NOTE: Ensure there is power going to the machine. See the base owner's manual for power cord info.

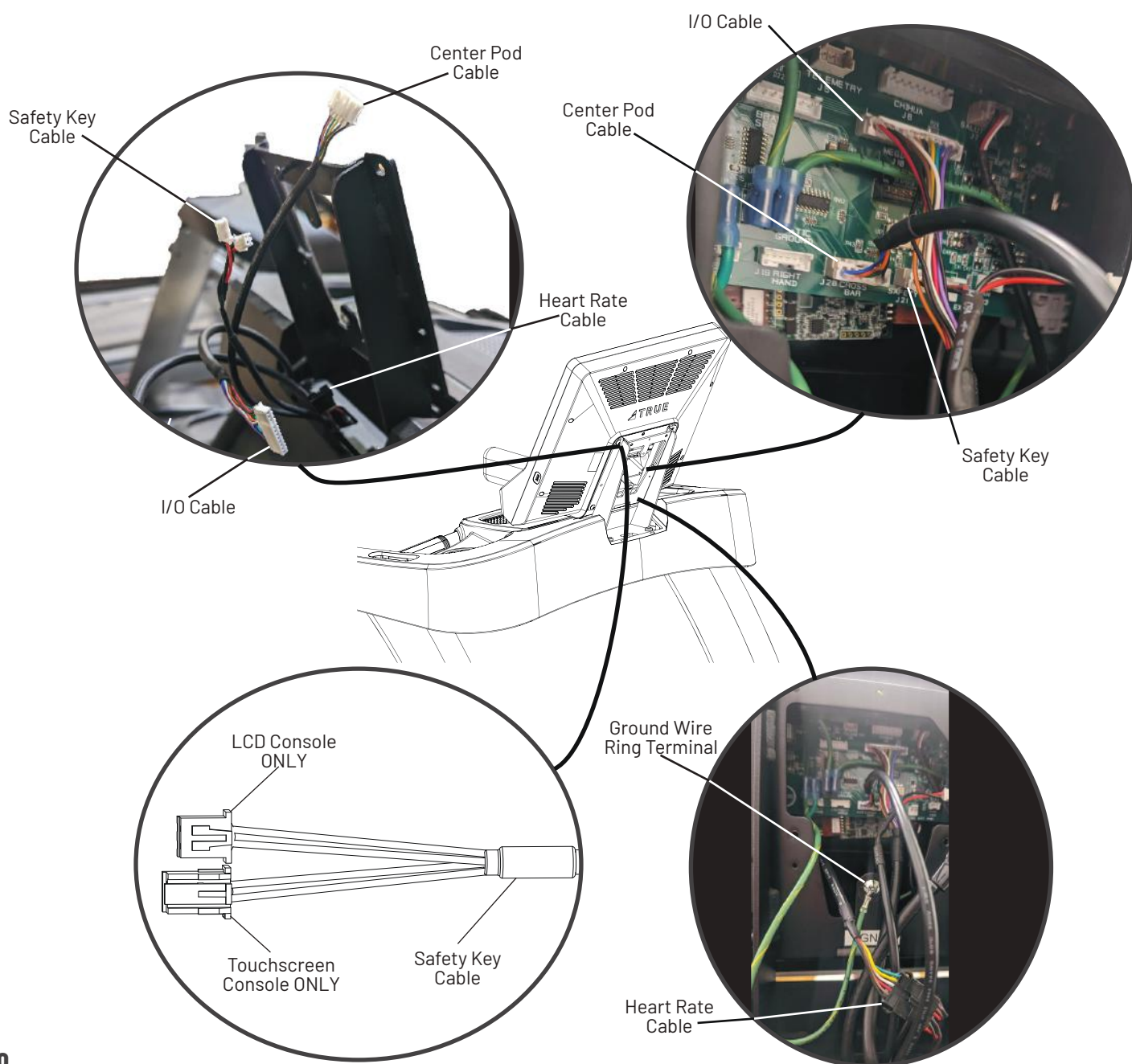

Step 3—Connect Power Cord

Example shown below—see the base assembly instructions for how to attach the power cord or power adapter to the base.

- A. Connect the power cord into the power inlet and then power on the machine.
- B. Verify the console powers up.

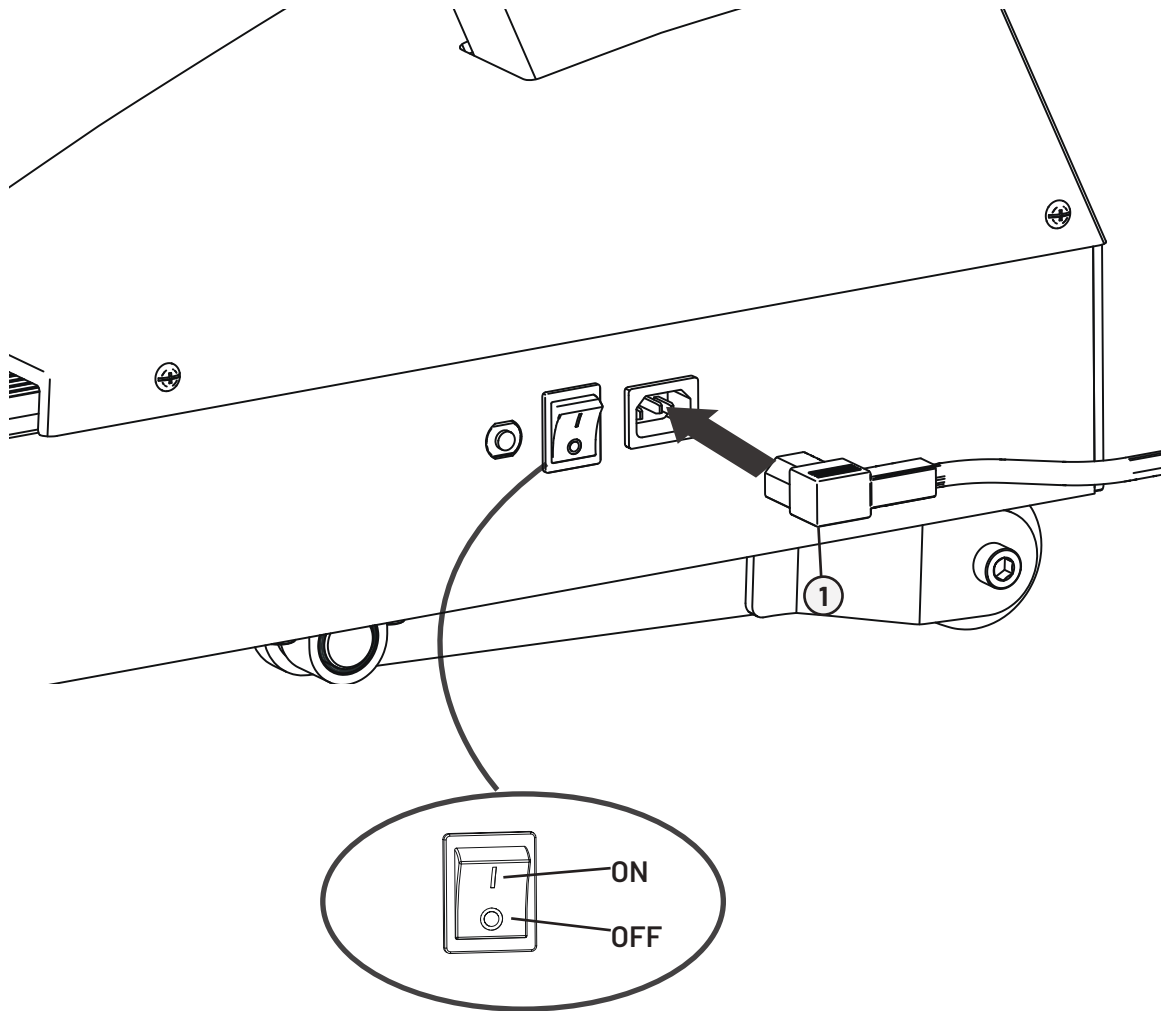

Step 4—Configure and Calibrate the Machine

Parts Used in this Step			
Item	Part	Description	Qty
1	N/A	CONSOLE	1

NOTE: All new products require configuration. However, not all new products require calibration. The TPS treadmills require calibration. If calibration is required, you must calibrate the machine.

NOTE: Users must select the correct base in configuration prior to calibration.

To enter configuration:

- A. If you're placing the console on the machine for the first time, select the correct base model and follow the on-screen instructions to complete the procedure.
OR
- A. To enter Service Mode, press and hold the **TRUE** logo (A) in the upper left corner of the home screen. When the word **TRUE** (B) begins to flash, release the logo and press and hold the lower right corner of the screen (C).



Step 4—Configure and Calibrate the Machine Continued

- B. The first screen displayed after entering Service Mode is the Service menu. In the Service menu, select **Utilities** (A) to highlight it. Press **NEXT** (B) to continue.

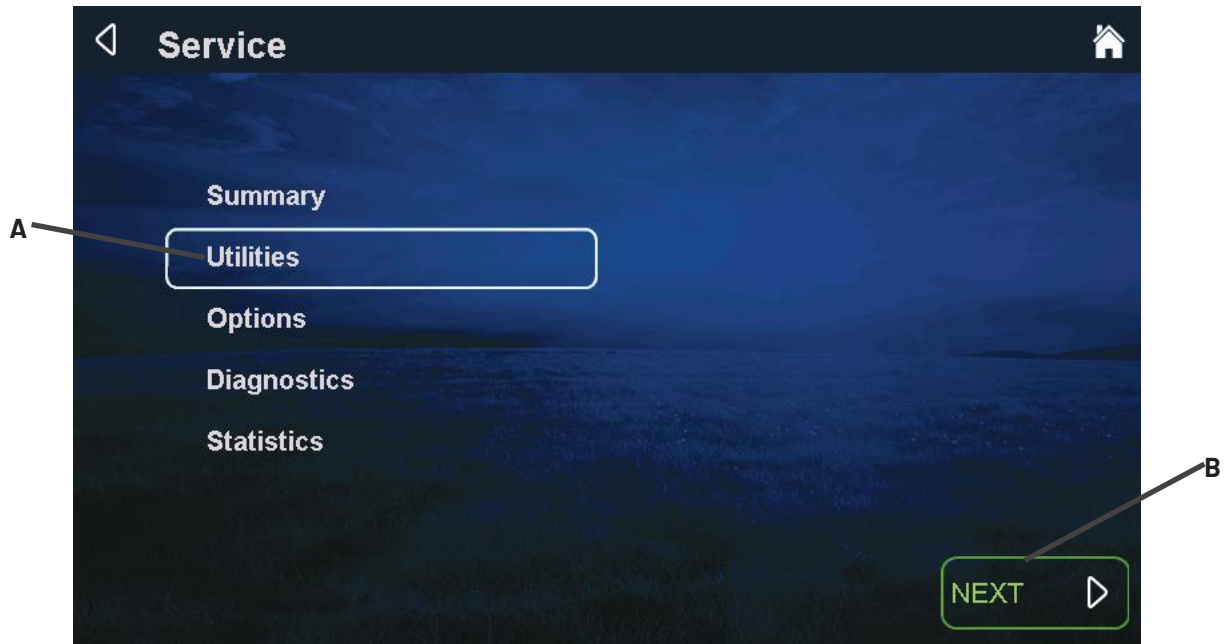

- C. Under Utilities select **Product Setup** (A). Press **NEXT** (B) to continue.

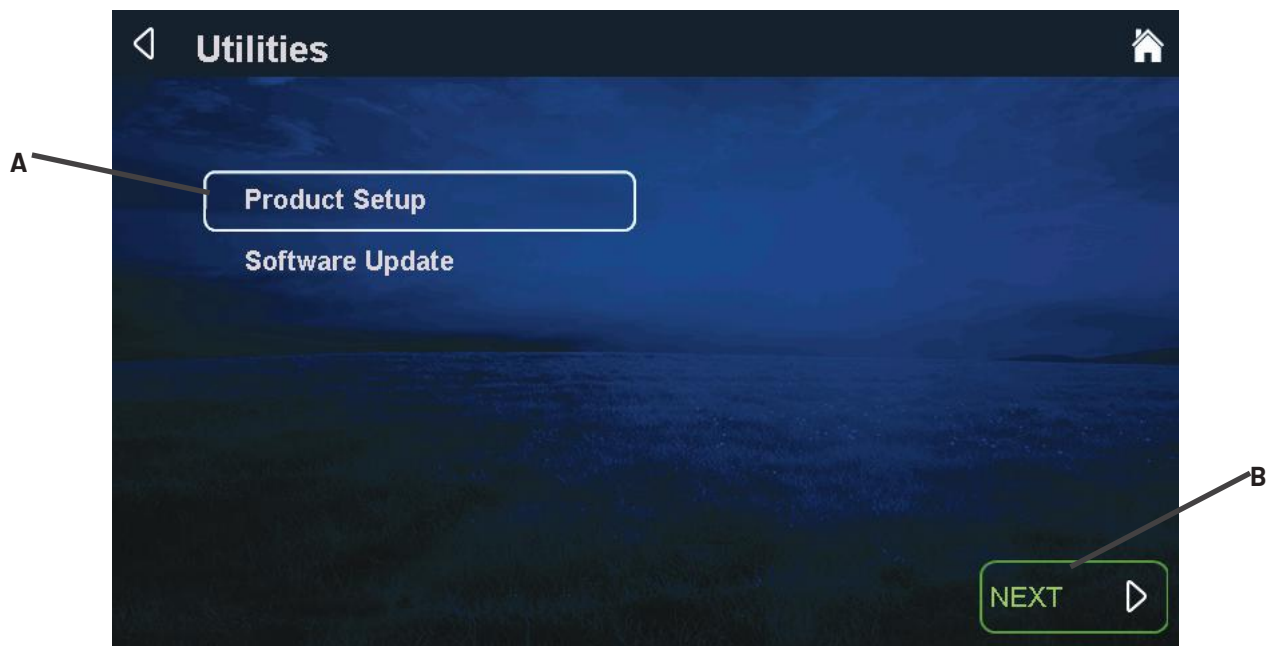

Step 4—Configure and Calibrate the Machine Continued

D. To configure the machine, press **Setup Wizard** (A).

E. In the Setup Wizard, select the correct base model and follow the on-screen instructions to complete the procedure.

NOTE: Misconfiguration of the console may cause damage to the unit and void the manufacturer warranty. If necessary, please contact TRUE Technical Support at 800-883-8783 for assistance.

NOTE: The image below may differ slightly based on the base unit used.

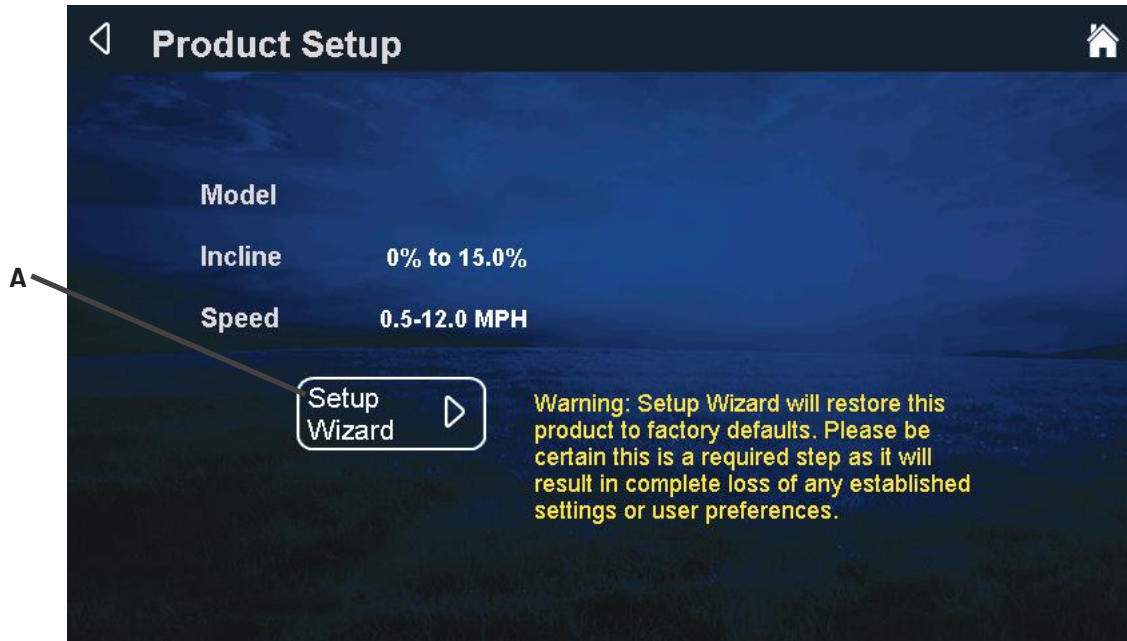

HOW TO CALIBRATE THE CONSOLE WITH THE BASE

To enter calibration:

A. Press and hold the **TRUE** logo (A) in the upper left corner of the home screen. When the word **TRUE** (B) begins to flash, release the logo and press and hold the lower right corner of the screen (C).



Step 4—Configure and Calibrate the Machine Continued

B. In the Service Menu, select **Diagnostics** (A) to highlight it. Press **NEXT** (B) to continue.

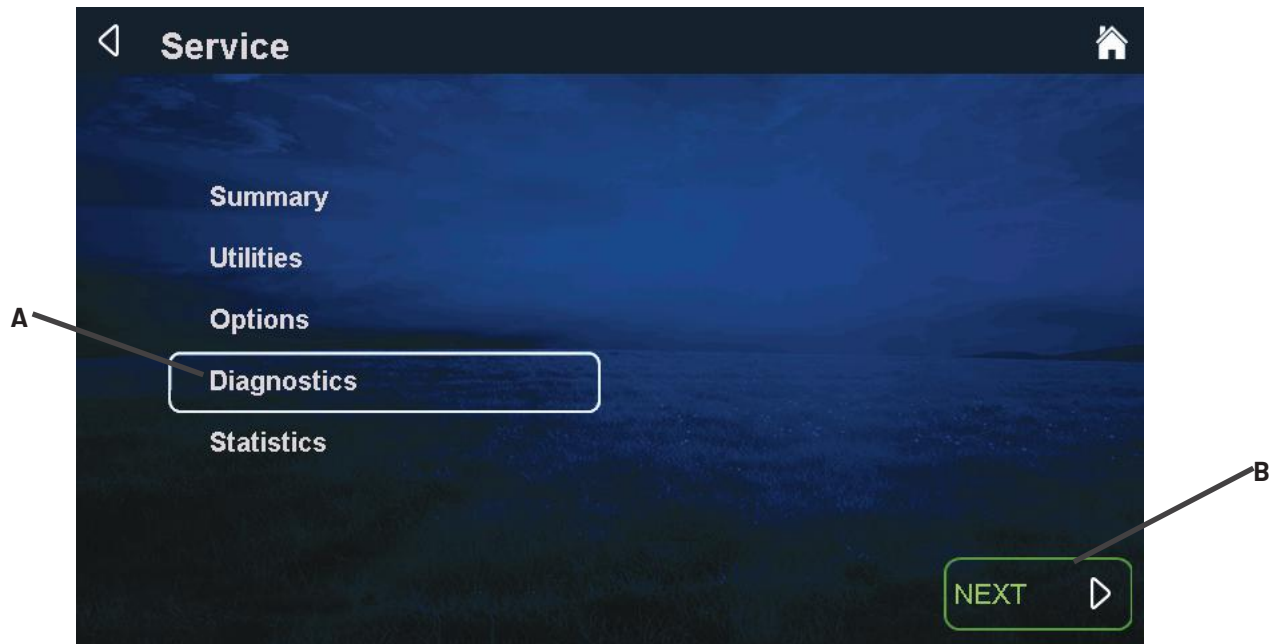

C. Under Diagnostics, select **Calibration/Test** (A) to highlight it. Press **NEXT** (B) to continue.

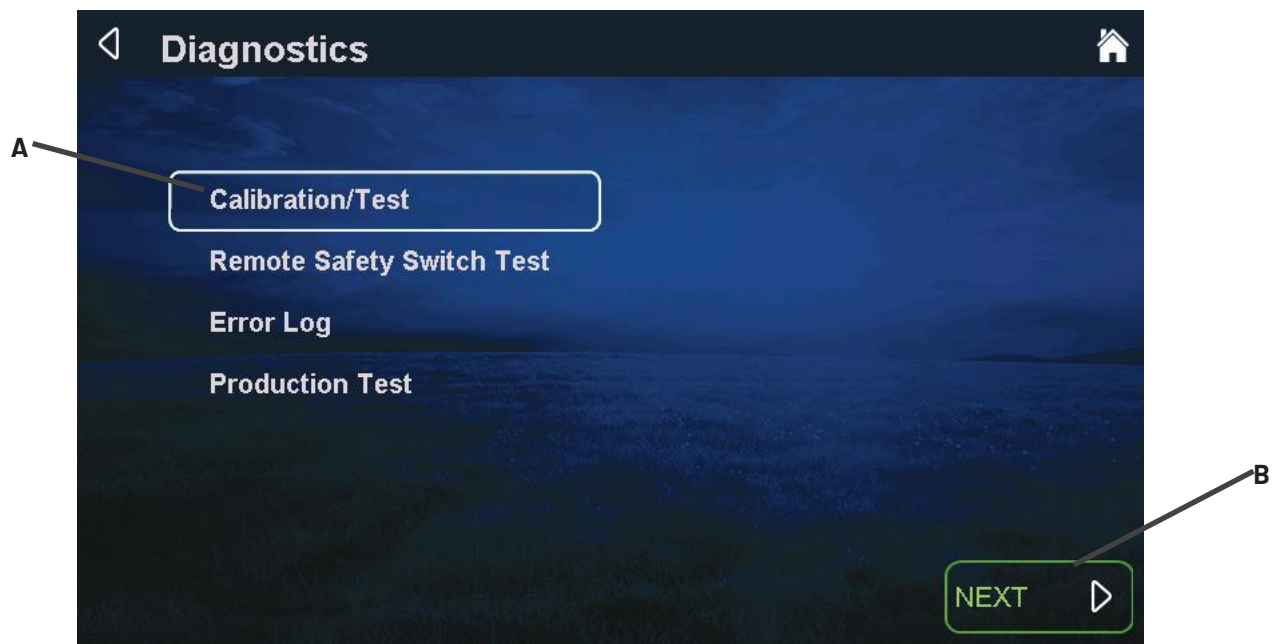

Step 4—Configure and Calibrate the Machine Continued

D. Under Calibration/Test, select **Speed/Incline Cal** (A) to highlight it. Press **NEXT** (B) to continue.

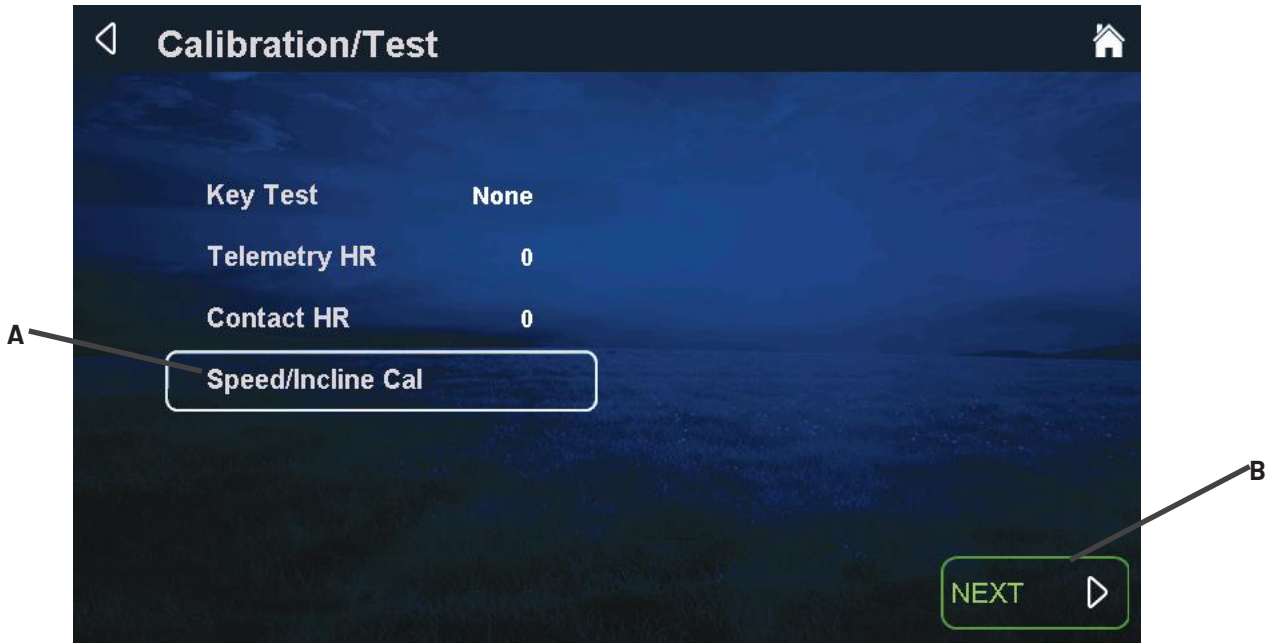

E. Under Speed/Incline Calibration, press **Run** (A) to begin calibration.

F. Once calibration is complete, turn the power off on the machine for 30 seconds.

⚠ WARNING: This process will take full control of the machine and can be dangerous if caution is not taken.

- Calibration can take up to two minutes to complete.
- Do not stand on the machine during the calibration procedure.
- Verify that the machine is free of all parts and tools.
- Keep children and animals at a safe distance.

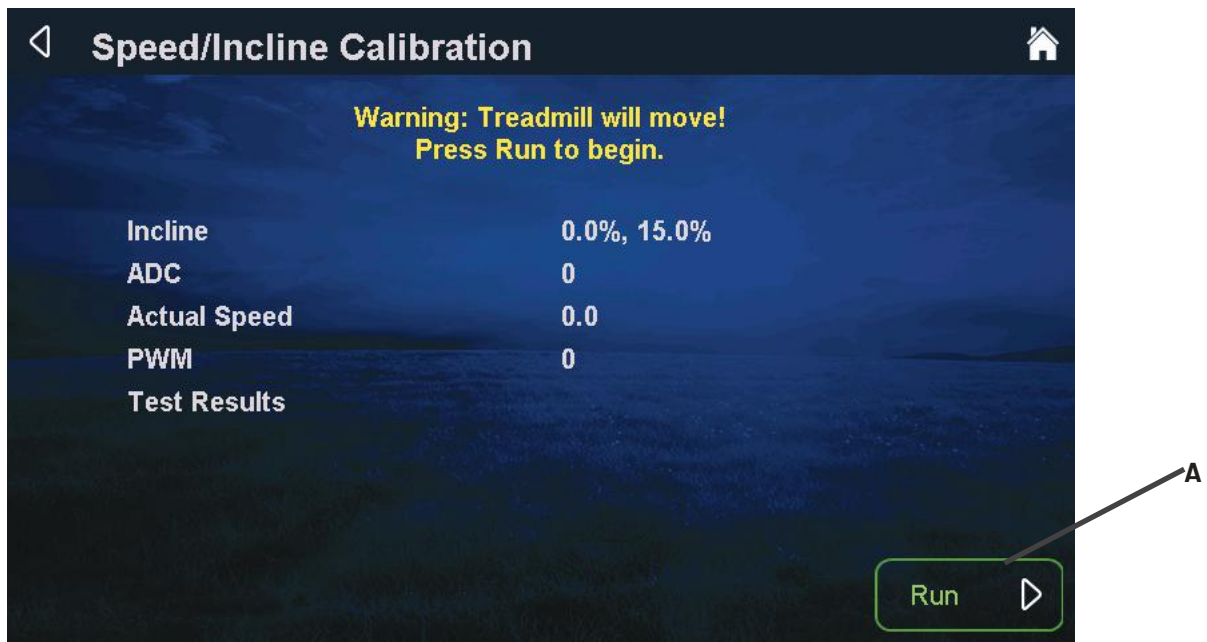

Step 5—Attach Rear Console Cover

Example shown below—see the base assembly instructions for how to attach the console rear cover.

Tools Used in this Step	
#2 Phillips Screwdriver	

Using a #2 Phillips screwdriver, secure the rear console cover to the console mast using the screws provided with the base.

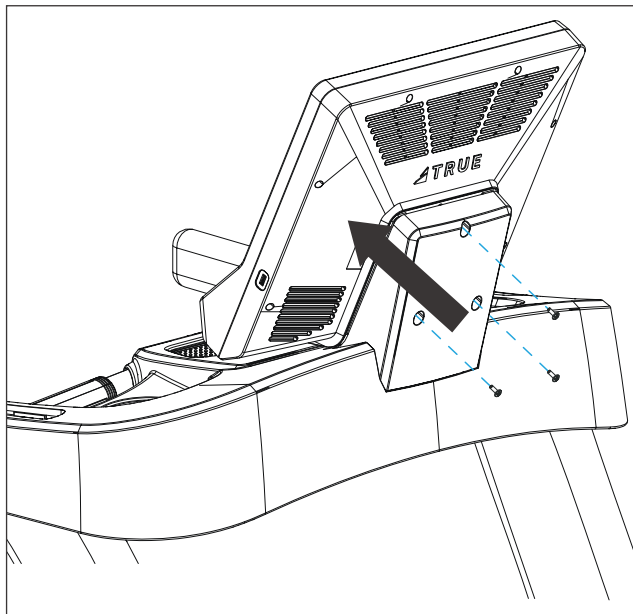





CONSOLE FEATURES





FEATURES OVERVIEW

- A. Capacitive Touchscreen Display
- B. USB Port
- C. Headphone Jack
- D. Reading Rack

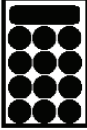

9" TOUCHSCREEN ICON DESCRIPTIONS

ICON*	DESCRIPTION
	Toolbox
	Home
	Cool Down
	Incline
	Speed/RPM

ICON*	DESCRIPTION
	Resistance/Workload/ Level
	Screen Toggle
	Keypad
	Up
	Down

*Icons vary by model.

WORKOUT PROGRAM DESCRIPTIONS

WORKOUT PROGRAMS	WORKOUT PROGRAM DESCRIPTION
QUICK START	A workout in which you control all settings. The workout continues until you end it.
MANUAL	Set up your own workout to a time or distance limit.
ROLLING HILLS	A series of increasing and decreasing workload changes that simulate rolling hills. Adjust your settings at any time during the workout to increase or decrease intensity of the hills.
SINGLE HILL	Incline/workload increases to a maximum at the mid-point of the workout, then decreases to the finish. Incline changes affect the current segment only. Speed changes are permanent.
RANDOM HILLS	A workload profile that changes to simulate random hills. Adjust the resistance or level at any time during the workout to increase or decrease the intensity of the hills.
HILL INTERVALS	Hill intervals are divided in work and rest segments. The set resistance/level is what determines work and rest. This workout will start with a two-minute rest segment then change to a two-minute work segment and will continue this cycle to the end of the workout.
WEIGHT LOSS HILLS	Two minute walking interval segments with incline alternating between hills and a nearly flat landscape. Speed changes are permanent; Incline changes affect the current segment only.
GLUTE BUSTER	A changing incline profile focuses on intense glute muscle use.
CALORIE GOAL	This workout allows users to choose a speed, incline and workout time combination that will achieve their calorie goal.
DISTANCE GOAL	Predetermined distance workout. This workout will only run the selected workout distance of 5K, 10K, 2mi or 4mi.
CARDIO CHALLENGE	Speed and incline increase to a maximum at the mid-point of the workout, then decrease to the finish. Incline and speed changes affect the current segment only.
WALK AND RUN INTERVALS	Walking then running intervals in one minute segments. Incline changes are permanent; speed changes affect the current segment only.
SPEED INTERVALS	Zero-incline speed intervals in one minute segments. Any incline changes are permanent while speed changes during the workout affect the current segment only.
SPEED RAMP	Speed increases to a maximum at the mid-point of the workout, then decreases to the finish. Speed changes affect the current segment only. Incline changes are permanent.
LEG SHAPER	A workout with speed changes to work the leg muscles with added intensity.
CARDIO 360 ARM SCULPTOR	Users challenge their upper body and core in this 10-minute, 3-motion program, and follow along at their own intensity.
CARDIO 360 LEG SHAPER	Users tighten and tone their legs and glutes, changing resistance on the fly.
5K WORKOUT	A popular distance run. Users choose their speed and the workout will end at 5 kilometers (3.1 miles). The user can control both the SPEED and INCLINE of the machine throughout the run.
10K WORKOUT	A challenging distance run. Users choose their speed and the workout will end at 10 kilometers (6.2 miles). The user can control both the SPEED and INCLINE of the machine throughout the run.
HALF MARATHON	A very challenging distance run. Users choose their speed and the workout will end at 21 kilometers (13.1 miles). The user can control both the SPEED and INCLINE of the machine throughout the run.

WORKOUT PROGRAM DESCRIPTIONS

WORKOUT PROGRAMS	WORKOUT PROGRAM DESCRIPTION
GERKIN FITNESS TEST	A fitness test uses heart rate to estimate the user's VO2 max. The test increases speed and incline gradually every minute and ends at the point where the user's heart rate reaches 85% of the maximum for their age.
CUSTOM ULTRA	This completely customizable workout setup allows both speed and incline control in up to 30 segments.
SAVED WORKOUTS	Access to previously saved manual workouts.
AUTO STRIDE*	This program will automatically adjust the stride length based on the user's speed during the workout. The stride length will automatically increase as the user increases their speed, and automatically decrease the stride length as the user slows down.
TARGET HRC**	Users choose their target heart rate. The machine begins in MANUAL control – The user should gradually increase the workout intensity until heart rate is within 10 bpm of their target. At this point, the machine takes over to control speed and incline to maintain heart rate within a few beats of the user's target.
WEIGHT LOSS HRC*	Based on age, this is a heart rate controlled workout at 65% of the user's maximum heart rate. This creates efficient fat burning without overtraining. The machine begins in MANUAL control –The user should gradually increase the workout intensity until their heart rate is within 10 bpm of their target. At this point, the machine takes over to control speed and incline to maintain heart rate within a few beats of the user's target.
AEROBIC HRC**	Based on age, this is a heart rate controlled workout at 80% of the user's maximum heart rate. This keeps the user in the optimum aerobic training range to improve cardio fitness. The machine begins in MANUAL control - gradually increase the workout intensity until the user's heart rate is within 10 bpm of their target. At this point, the machine takes over to control speed and incline to maintain heart rate within a few beats of the user's target.
INTERVALS HRC**	Intervals of work and rest determined by target heart rate. The machine begins in MANUAL control – Users should gradually increase their workout intensity until their heart rate is within 10 bpm of their target. At this point, the machine takes over to control speed and incline to maintain the user's HR within a few beats of their target. The rest segment will reduce to 65% intensity of work segment.
HRC CRUISE CONTROL*	You must be in a workout to activate HRC Cruise Control. While in any program, cruise control enables you to set the current heart rate as the target heart rate by pressing a single button. The cruise control program takes control of the settings to maintain your target heart rate. If Beats Per Minute (BPM) exceeds the target heart rate by more than 12 BPM, then the workout will end and cool down will begin.

*Modes within a workout.

**The TRUE Heart Rate Control (HRC) workouts are unique because users must enter the key parameters of the workout; target heart rate, maximum speed, maximum incline, maximum resistance, and time, prior to beginning the HRC workout. As users approach their target heart rate, the console automatically takes over and changes the workload automatically to keep users near their target heart rate. This allows for a completely "hands free" workout.

NOTE: A Polar® compatible heart rate monitoring chest strap should be worn during HRC workouts. For increased safety and accuracy, contact heart rate monitoring is not recommended for HRC workouts.

HEART RATE INFORMATION

HEART RATE MONITORING

TRUE cardio equipment can monitor a user's heart rate using a Polar* 5kHz compatible chest strap or the metal grips on the hand rails (called contact heart rate or CHR pads). The chest strap transmits the user's heart rate to the console via radio, and the console reads the user's heart rate.

Chest Strap Heart Rate Monitoring

Although TRUE cardio equipment functions fine without using the heart rate monitoring feature, this kind of monitoring gives valuable feedback on the user's effort level. Using chest strap monitoring also allows users to use Heart Rate Control, the most advanced exercise control system available. When users wear a Polar® compatible transmitter strap, the machine will display the user's heart rate as a digital beats-per-minute (bpm) readout. A chest strap should be worn directly against the user's skin, about 1-2 inches below the pectoral muscles/breast line. Women should be careful to place the transmitter below their bra line. All transmitters should be worn in accordance with the manufacturer's documentation. Initially the transmission signal for heart rate may be erratic or non-existent. Some moisture is necessary between the strap and the user's skin for proper transmission. Sweat from exercise works best, but ordinary tap water may be used prior to the workout if desired.

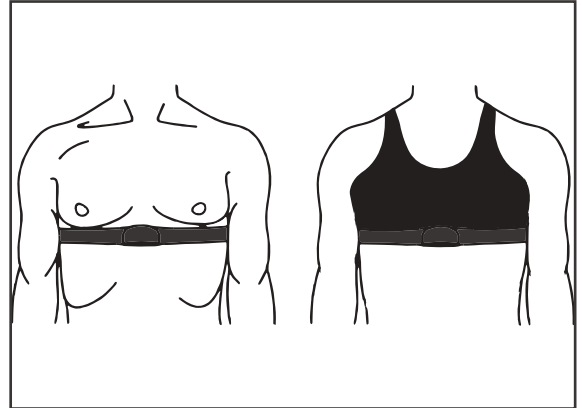

NOTE: The chest strap produces a radio signal that the console reads and registers as the user's heart rate. The accuracy of a reading may be affected when outside interference is present.

Contact Heart Rate (CHR)

The CHR system will let the user monitor their heart rate without wearing a chest strap. When using the CHR system users should gently grasp the CHR pads with both hands. Within 30 seconds, the user's heart rate should be displayed as a digital bpm readout (during the first 30 seconds the system is analyzing and locking in the user's heart rate). Users should exercise with smooth body motions and breathe regularly. It is best to avoid talking while using the CHR system, as talking will cause unrepresentative heart rate spikes of 5 to 10 bpm. To ensure an accurate reading, the user's hands should be clean, free of both dirt and hand lotions.

NOTE: For increased safety and accuracy the CHR system should only be used at speeds of 4 mph or lower (CHR readings are less accurate due to large muscle movements above this speed).

NOTE: CHR monitoring may be less accurate than chest strap monitoring since the heart rate signals are much stronger at the chest. When using a HRC workout, it is best to use a chest strap because of the stronger and more accurate readings.

CAUTION: Do not use the contact heart rate grips as a handlebar during a workout.

HEART RATE CONTROL (HRC)

You are now the owner of the most sophisticated Heart Rate Control (HRC) cardio equipment available. TRUE HRC is unique and patented. It accommodates users from rehabilitation to world class athletes, and all those in between. TRUE HRC allows users to do a completely hands-free heart rate controlled workout using speed, incline, and/or resistance. By training at a specific target heart rate, users can exercise at a more efficient cardiovascular level.

The TRUE HRC system is unique because users must enter the key parameters of the workout; target heart rate, maximum speed, maximum incline, maximum resistance, and time, prior to beginning the HRC workout. As users approach their target heart rate, the console automatically takes over and changes the workload automatically to keep users near their target heart rate. This allows for a completely “hands-free” workout.

NOTE: A Polar® compatible heart rate monitoring chest strap should be worn during HRC workouts. For increased safety and accuracy, contact heart rate monitoring is not recommended for HRC workouts.

Target Heart Rate

TRUE’s Heart Rate Control (HRC) workouts let the machine monitor relative exercise intensity by way of the user’s heart rate, then automatically adjust the speed and incline to keep the user at their target heart rate and thus their desired exercise intensity. Heart rate is a good measure of the body’s exercise stress level. It reflects differences in physical condition, fatigue, the comfort of the workout environment, even diet and emotional state. Users should compare their heart rate with how they feel to ensure safety and comfort.

Consult a Physician to Determine Heart Rate

Using heart rate to control a workout takes the guesswork out of the workout settings. Consult a physician before using heart rate controlled workouts for advice on selecting a target heart rate range. Also, it is important to use the machine for several workouts in the manual mode while monitoring heart rate. Users should compare their heart rate with how they feel to ensure safety and comfort. After users have spent some time learning how their heart responds to different levels of speed and incline, they will have a better understanding of how to select the maximum speed and maximum incline and maximum resistance required for reaching their target heart rate.

Warm Up

At the beginning of an HRC workout, the machine is in full Manual Control mode. Users should gradually increase the workout intensity to slowly raise their heart rate to within 10 beats per minute (bpm) of their target heart rate. The machine will operate as if in manual mode during the warm up stage. Users control both speed, incline, and resistance. The user may only increase speed, incline, and resistance to the present maximum values entered. It is important that the user starts at a low level of perceived exertion and gradually increase the workout intensity over several minutes until they approach their target heart rate. This allows the body to adapt to the workout. Increasing the workout intensity gradually will allow the user to enter the Heart Rate Control stage without overshooting their target, keeping their heart rate within a few bpm of their target.

NOTE: Warming up too fast may cause the user to overshoot their target. If this occurs it may take several minutes before the computer software can control their heart rate. Users may overshoot and undershoot for several minutes until control is achieved.

Heart Rate Control Stage

The machine takes control of speed, incline, and resistance, keeping the user’s heart rate within a few bpm of their target. When using the Interval HRC Workout, the machine alternates between work and rest intervals.

Cool Down

At the end of the workout time or distance, the machine reduces the workout intensity by half and goes back into manual control mode, where users directly control their cool down.

CONSOLE NAVIGATION

HOME SCREEN

Home Screen

The Home Screen is displayed on the console when there is no workout in progress. From this screen the user is able to select from various options to begin a workout.



A. Quick Start

Starts a Quick Start workout in which the user controls all settings until the workout is ended by the user.

B. User Profiles

Custom profiles used to store a user's age, weight, and saved workouts.

C. Last 10 Workouts

Displays the last 10 workouts that were completed on the machine and allows users to easily replay a recent workout.

D. New User

Creates a new User Profile.

E. Workout Finder

Displays a list of the preprogrammed workouts that are available on this machine.

F. Bluetooth

Allows users to pair their Bluetooth devices prior to beginning a workout.

SELECTING A PRESET WORKOUT

Selecting a Preset Workout

Preset workouts are accessed by selecting **WORKOUT FINDER** from the Home Screen. To view the description of a workout (A), select the workout by touching it (B). Once the desired workout has been selected, simply press **NEXT** (C) to proceed.

NOTE: Workouts can be viewed by category by pressing **i** (D).

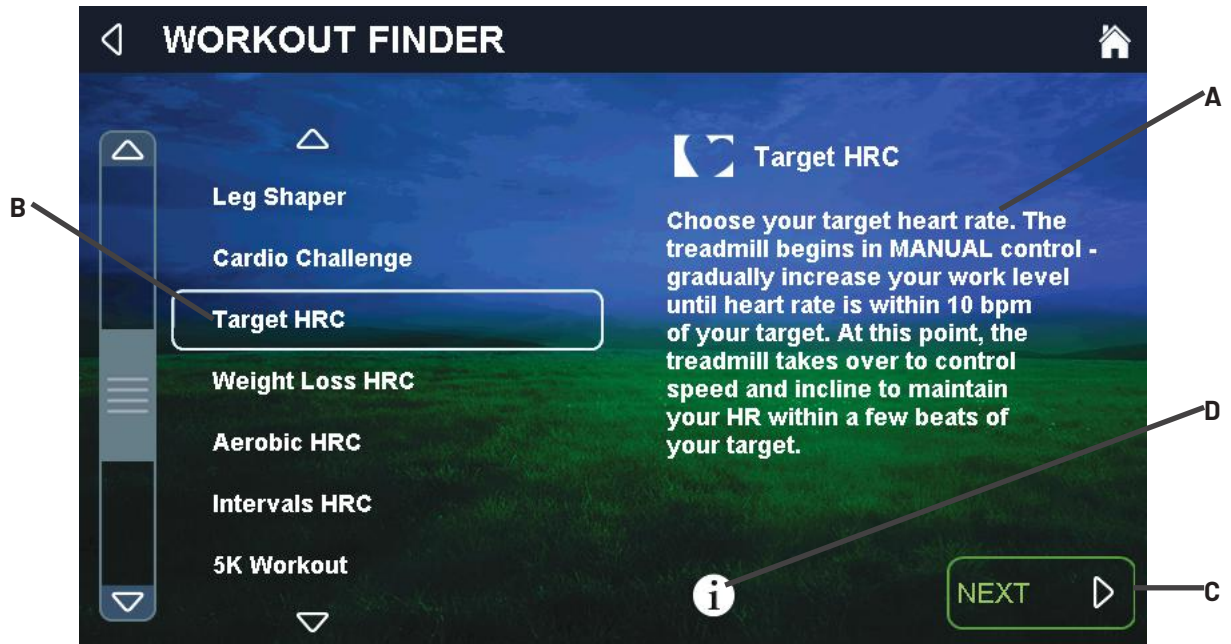

Workout Data Entry Screens

These screens allow users to input their personal information or workout goals prior to beginning a workout. To set a value, touch the value to be changed (A) and use the **KEYPAD** (B) to adjust the value to the desired setting. Once all values are set, touch **START** (C) to begin the workout or **SAVE?** (D) to save the workout to a user profile.

NOTE: Workout Data Entry Screens vary by program selection.

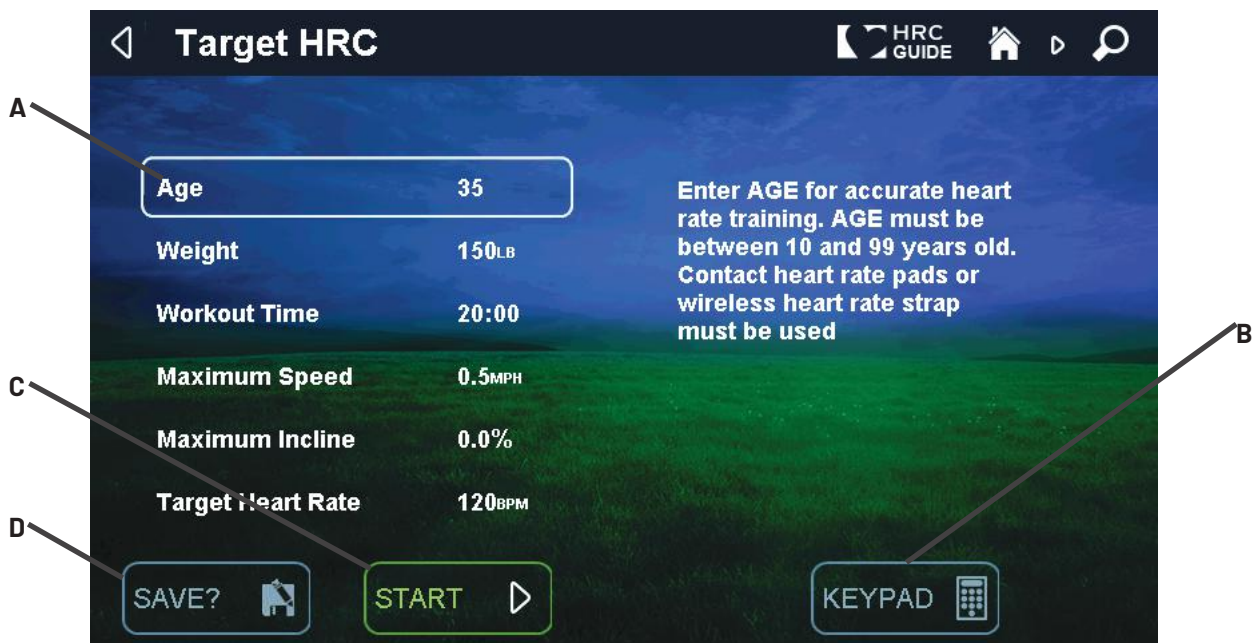

WORKOUT DATA SCREENS

Workout Data Screens

During any workout a Workout Data Screen will be displayed to give the user a comprehensive visual overview of their current workout data.

NOTE: The image below may differ slightly based on the base unit used.

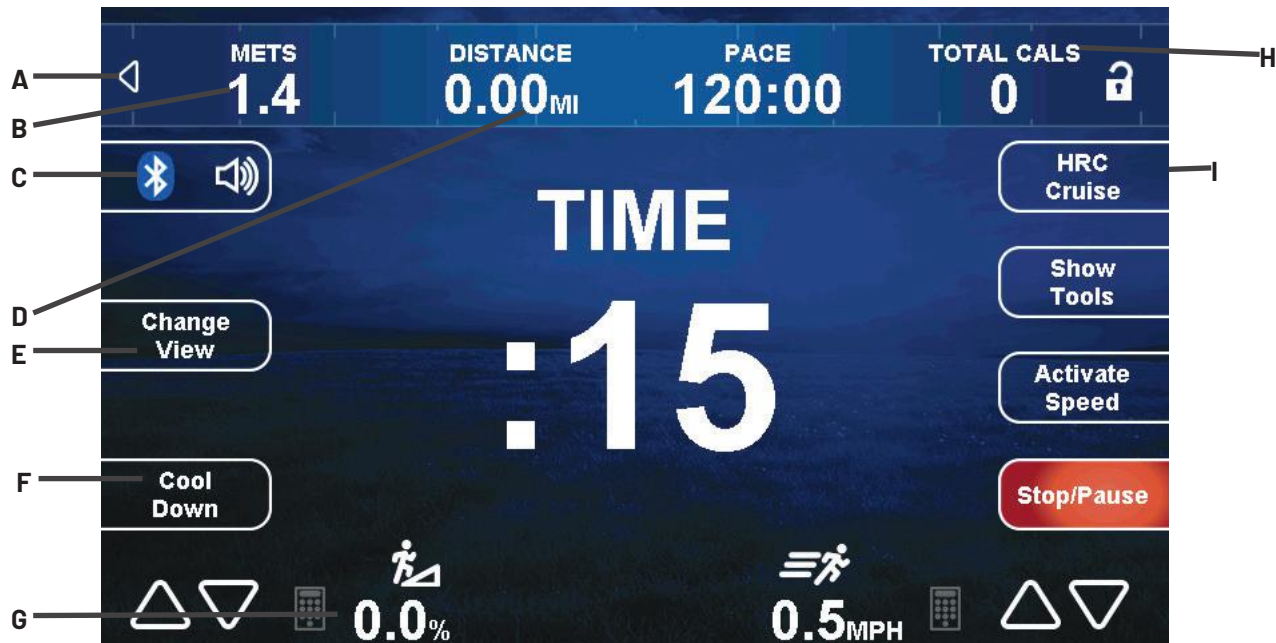

A. Statistics Bar

Displays data such as Calories, METS, Distance, Time and Heart Rate during a workout. This may be hidden by touching the arrow on the left side of the bar.

B. Calories/METs Display

During the workout, this display will alternately show the calories burned and the METS (Metabolic Equivalent) calculation up to the current moment of the workout..

C. Bluetooth

Enables or disables the Bluetooth audio function.

D. Distance

Displays the virtual distance traveled up to the current moment of the workout.

E. Change View

Switches between the available Workout Data Screens.

F. Cool Down

Allows the user to end their current workout with a two minute low intensity cooldown period. When Cool Down is activated the unit is in manual mode and the user directly controls all settings.

G. Incline/Level

Displays the current level of incline or resistance. The incline or resistance level can be changed by pressing the keypad icon and entering a numeric value, or by pressing the up and down quick touch incline/level keys.

H. Total Calories

Displays the total calories burned during the workout.

I. HRC Cruise

Engages Heart Rate Control to allow the equipment to maintain the user's current heart rate through automatic speed and incline adjustments (when the user is utilizing heart rate monitoring).

WORKOUT DATA SCREENS

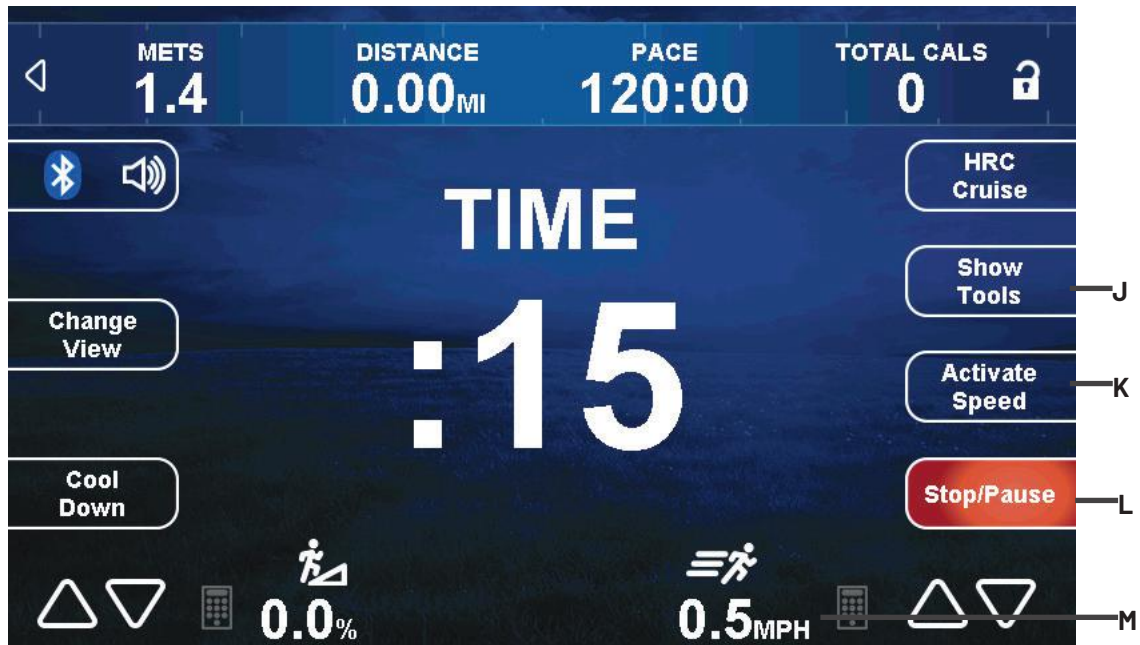

J. Show Tools

Gives the user the following options:

- Customize the data shown in the Statistics bar.
- Change units between English and Metric.
- Pair a Bluetooth heart rate strap.

K. Quick Touch

Displays various preset speed, level, and incline levels to allow the user to quickly and conveniently customize their workout.

L. Stop/Pause

Allows the user to stop or pause the workout at any time.

M. Speed/RPM

Displays the current machine speed or RPM (revolutions per minute). The speed or level can be changed by pressing the keypad icon and entering a numeric value, or by pressing the up and down quick touch speed/RPM keys.

N. Time/Remaining (Not Pictured)

During the workout, this display will alternately show the time elapsed in the workout and the time remaining before the workout ends.

NOTE: This field will not populate during a Quick Start or Manual workout.

WORKOUT DATA SCREENS

Show Tools

Tapping **Show Tools** (A) will display various options. Tapping **Bike Mode** (B) toggles it on, displays the MPH dial (C) and simulates riding a 21-speed (D) road bike. The resistance changes to constant torque against the pedals and calculates speed (E) for a more realistic biking experience. Tapping the **+ and -** buttons (F) will change the simulated gears. Tapping **KPH/MPH** (G) will toggle between having all values displayed as English or Metric units. Tapping the **Heart Rate Workout Data** button (H) allows the user to choose the type of Bluetooth Heart Rate device.

NOTE: The image below may differ slightly based on the base unit used.

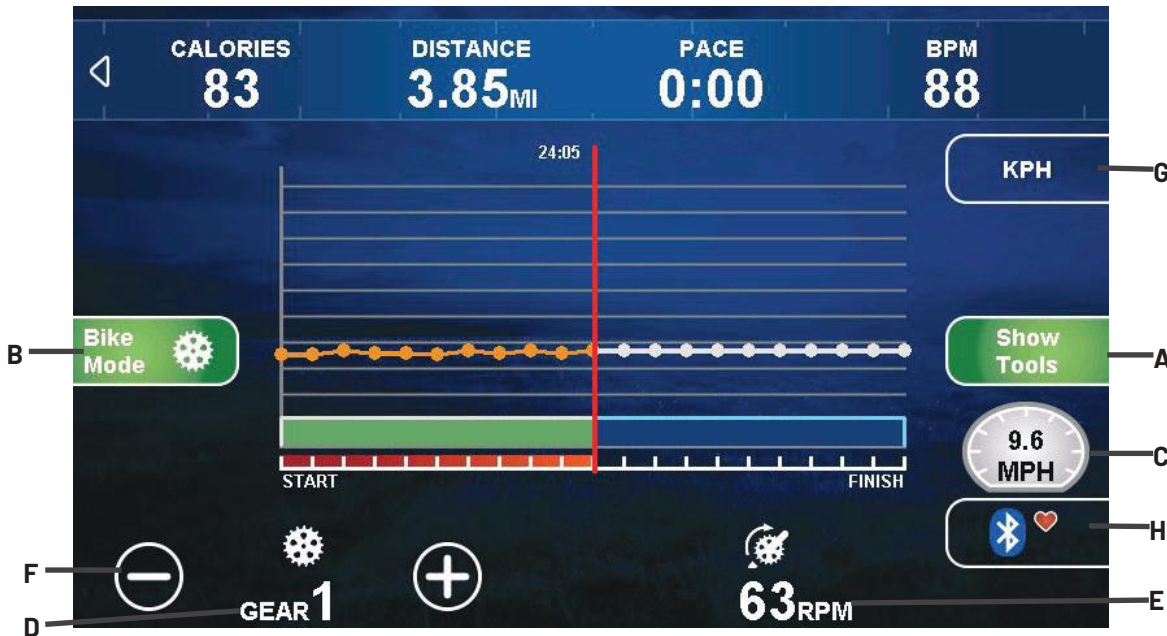

Workout Summary Screen

At the end of a workout the Summary Screen will display an overview of the workout data (A). The workout data can be exported to another device through the Bluetooth connection. Return to the Home Screen by tapping **HOME** (B).

NOTE: The image below may differ slightly based on the base unit used.

WORKOUT SUMMARY

	WORKOUT	COOL DOWN	TOTAL
ELAPSED TIME	109:01	:00	109:01
AVERAGE HEART RATE	88	-	88 BPM
MAXIMUM HEART RATE	105	-	105 BPM
AVERAGE PACE	60 RPM	0 RPM	60 RPM
MAXIMUM PACE	63 RPM	0 RPM	63 RPM
DISTANCE	17.48	0.00	17.48 MI
CALORIES	378	0	378

HOME **B**

USER PROFILES

Creating a New User

To create a new user profile, touch **NEW USER** on the Home Screen and the NEW USER screen will appear. Tap the information (A) on the left side of the screen to edit it. Once all of the information is complete, touch **BACK** (B) to return to the home screen.

NOTE: The number of user profiles is limited to six.

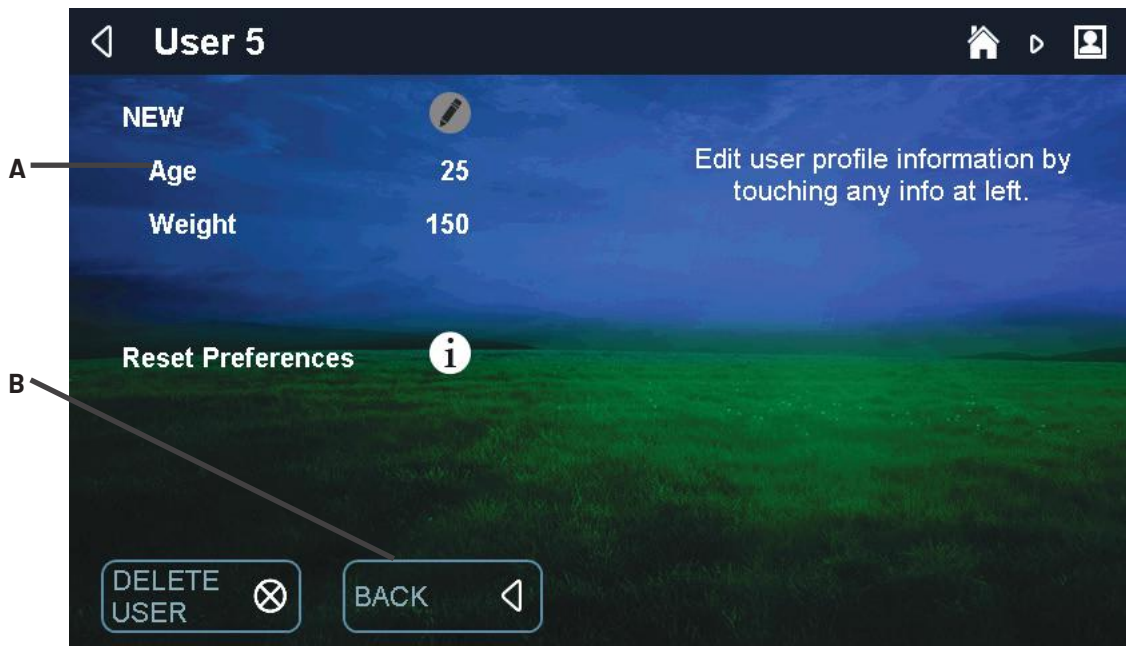

Beginning a Workout

Tap the desired user profile on the Home Screen to display the User Profile. From this screen the user can replay their last workout by touching **START** (A), replay a saved workout by touching **SAVED WORKOUTS** (B) or find a new workout by touching the **WORKOUT FINDER** (C).

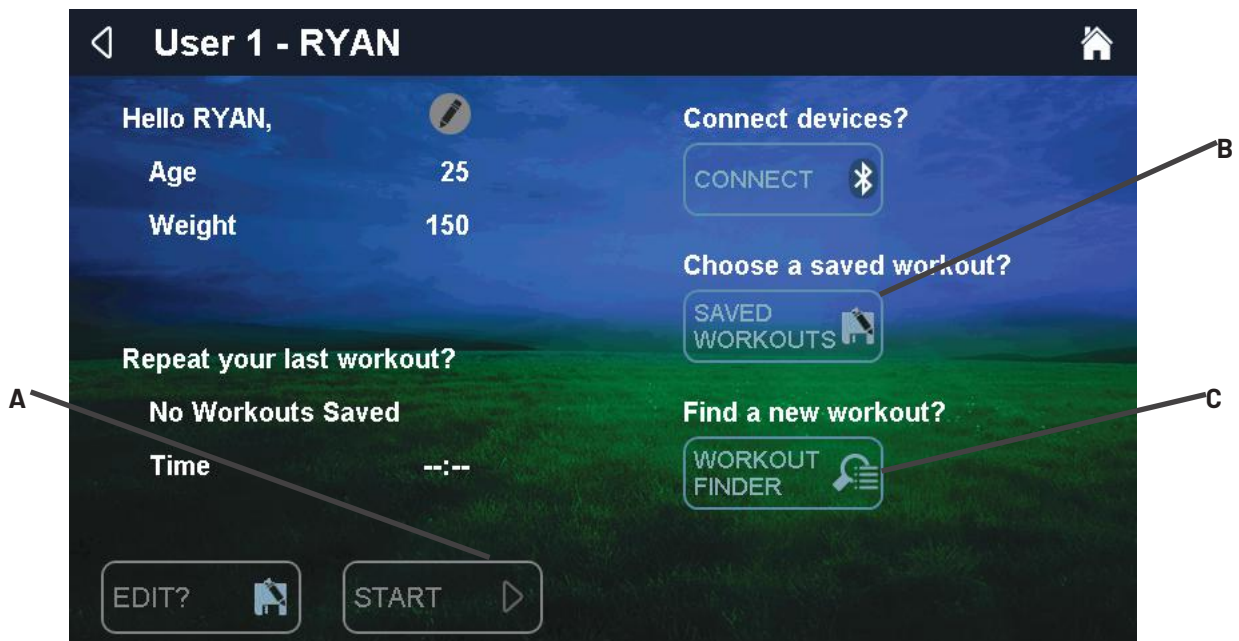

BLUETOOTH FUNCTIONS

Bluetooth Audio (Before Workout)

Tap **Bluetooth** on the Home Screen or in a User Profile to display the CONNECTIVITY screen. Touch **PAIR** (A) on the console to begin the pairing process. From the Bluetooth menu on your audio device, select the device listed on the console (B) to complete the pairing process.

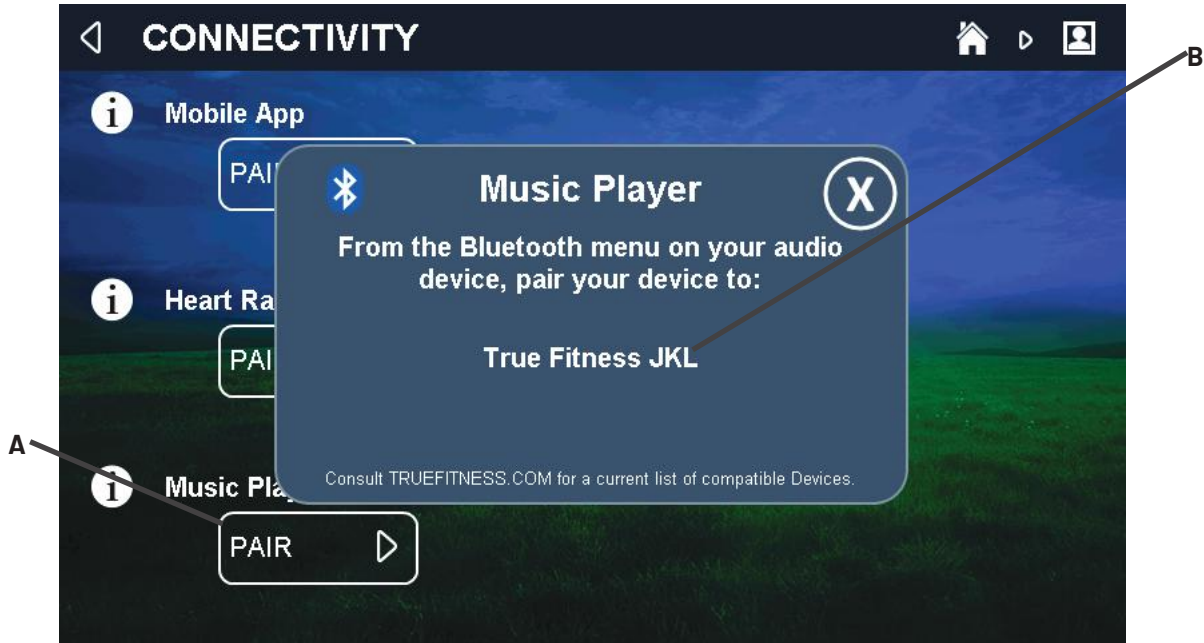

Bluetooth Audio (During Workout)

Tap **Bluetooth** (A) on the WORKOUT DATA screen to display the CONNECTIVITY screen and begin the pairing process. From the Bluetooth menu on your audio device, select the device listed on the console (B) to complete the pairing process.

NOTE: When an audio source is selected the user is given control over volume (C), and track adjustments (D).

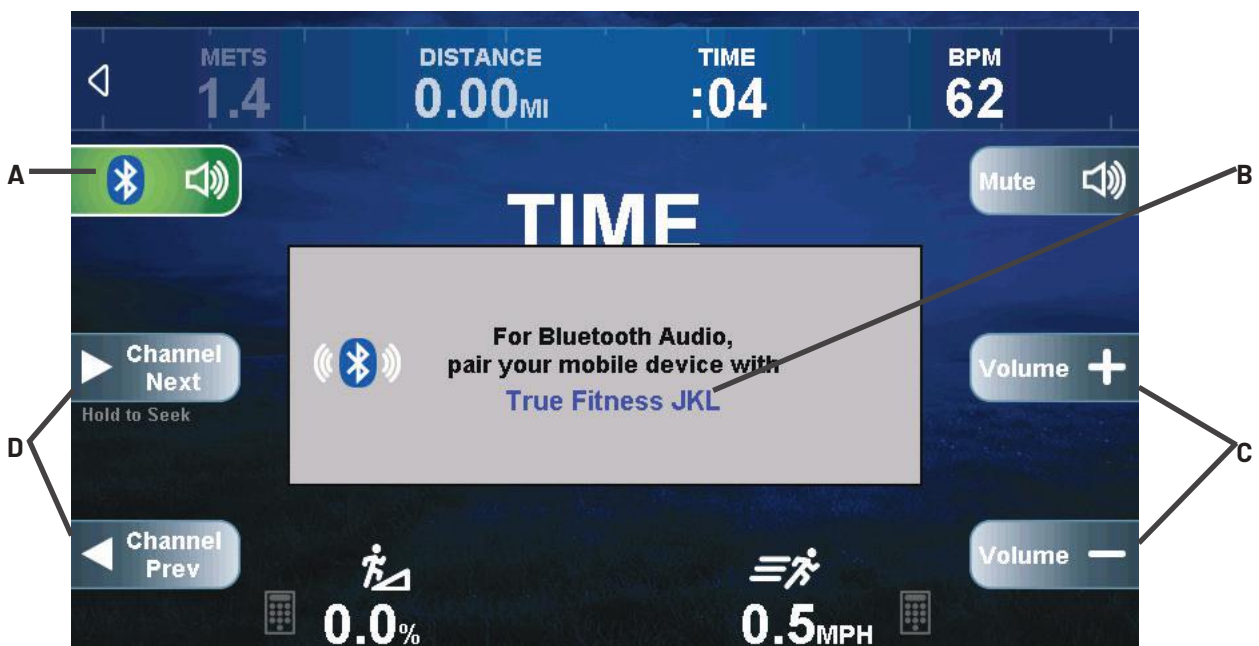

BLUETOOTH FUNCTIONS

Bluetooth Heart Rate (Before Workout)

Tap **Bluetooth** on the Home Screen or in a User Profile to display the CONNECTIVITY screen. Touch **Heart Rate PAIR** (A) to display the Heart Rate Pairing screen. Tap **Bluetooth HR** (B) and then select the desired device from the list provided.

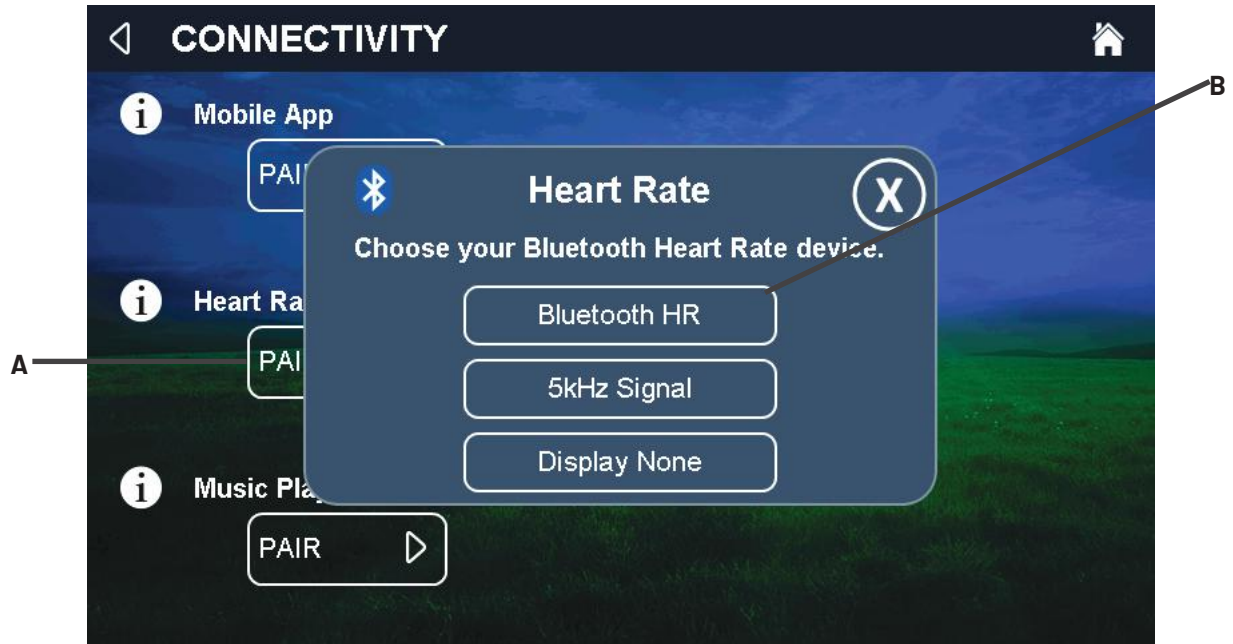

Bluetooth Heart Rate (During Workout)

To pair a Bluetooth heart rate strap, tap **SHOW TOOLS** on the Workout Data screen, then press **Bluetooth Heart Rate** (A) and select the desired strap from the list (B).

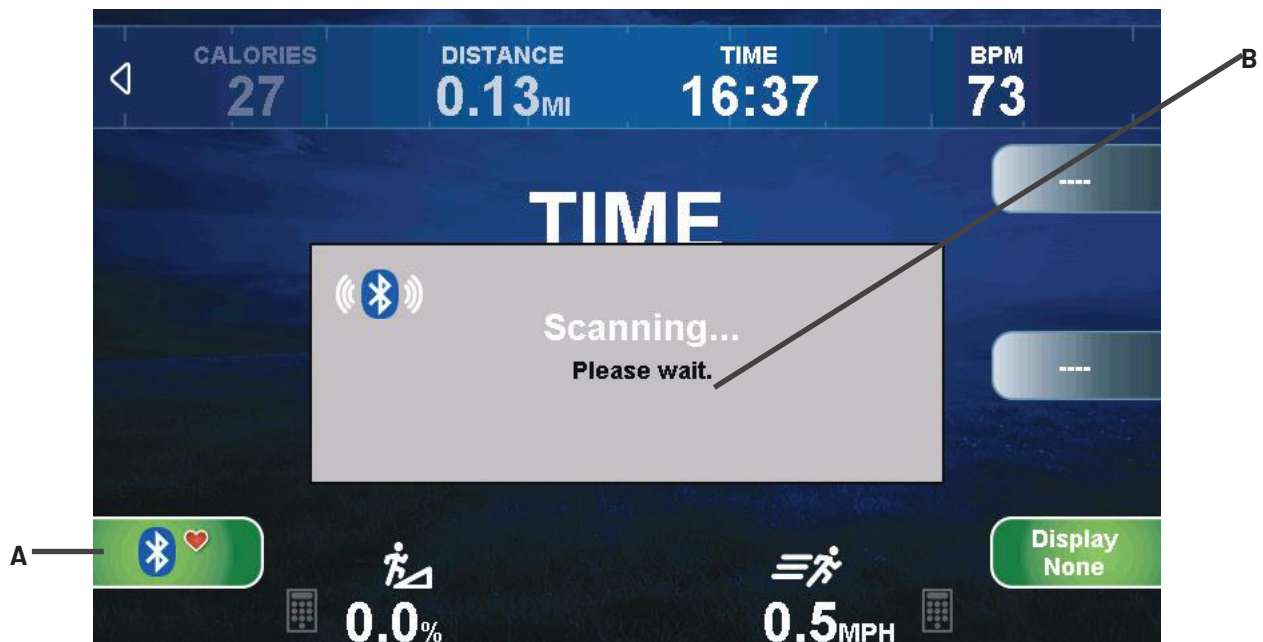

BLUETOOTH FUNCTIONS

Mobile Fitness App Pairing

This console is compatible with GymTrakr fitness tracking apps. To pair a compatible app, tap **Bluetooth** on the Home Screen or in a user profile to display the connectivity screen. Touch **Mobile App PAIR** (A) to display the **Mobile App Pairing** screen. From the fitness app, pair to the device (B) shown on the console.

NOTE: For additional information on compatible mobile apps, please visit www.truefitness.com



ADVANCED CONSOLE FUNCTIONS

Entering Service Mode

Press and hold the **TRUE** logo (A) in the upper left corner of the home screen. When the word **TRUE** (B) begins to flash, release the logo and press and hold the lower right corner of the screen (C).

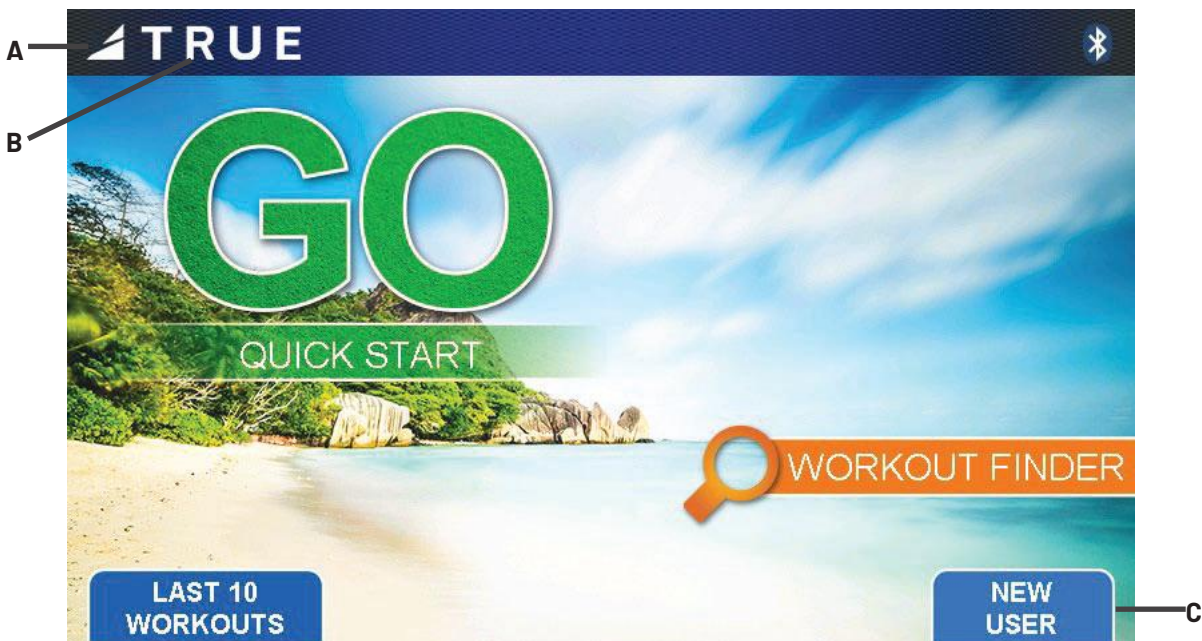

ADVANCED CONSOLE FUNCTIONS

Service Menu

The first screen displayed after entering service mode is the Service menu. From this menu technicians can access all of the service mode features by selecting different categories. To select a category, touch the desired category (A) to highlight it. Once a category has been selected, press **NEXT** (B) to continue.

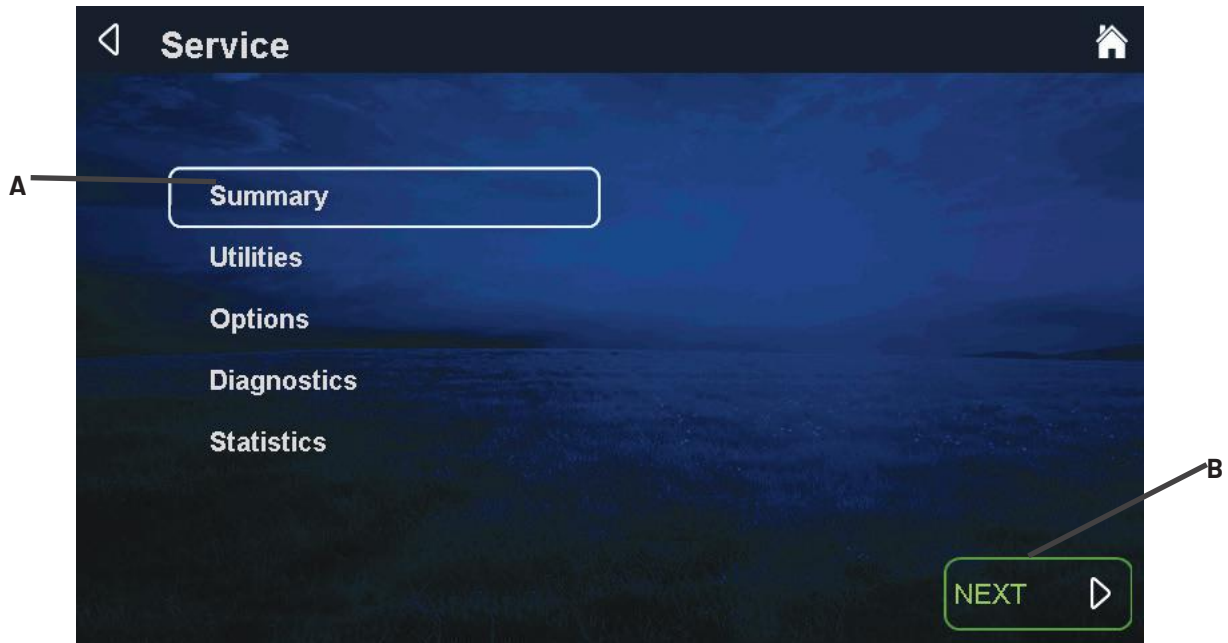

Summary Screen

The Summary screen provides an overview of the unit's current settings.

NOTE: Values cannot be changed in this screen.

NOTE: The image below may differ slightly based on the base unit used.

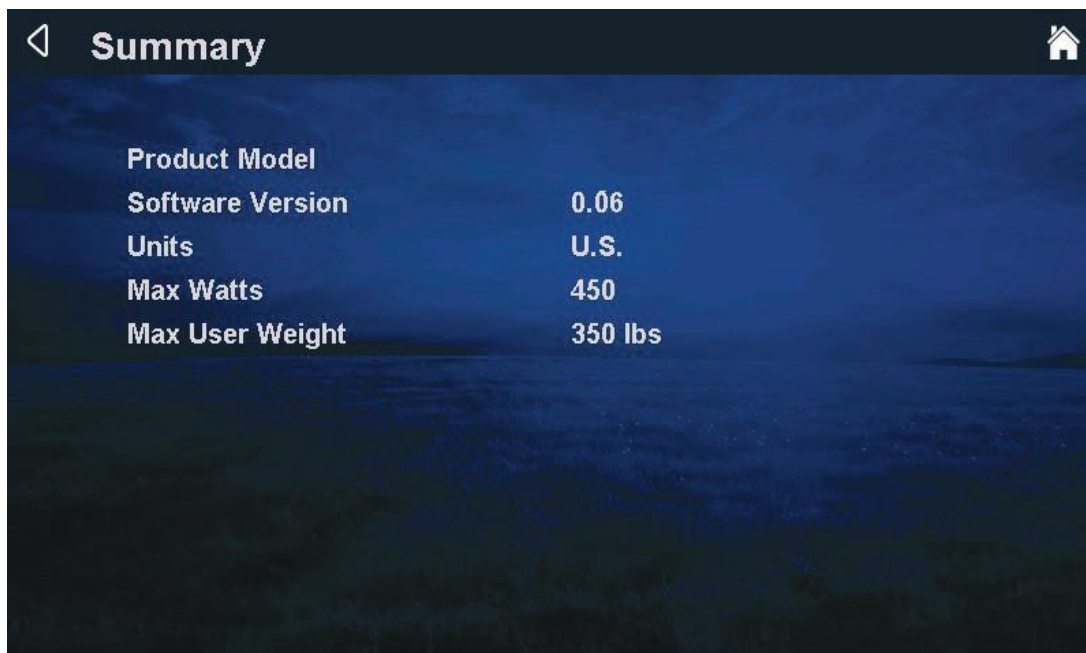

ADVANCED CONSOLE FUNCTIONS

Utilities Menu - Product Setup

The Product Setup screen allows the technician to adjust model configuration. To configure the machine, press **Setup Wizard** (A) and follow the on-screen instructions to complete the procedure.

NOTE: Misconfiguration of the console may cause damage to the unit and void the manufacturer warranty. If necessary, please contact TRUE Technical Support at 800-883-8783 for assistance.

NOTE: The image below may differ slightly based on the base unit used.

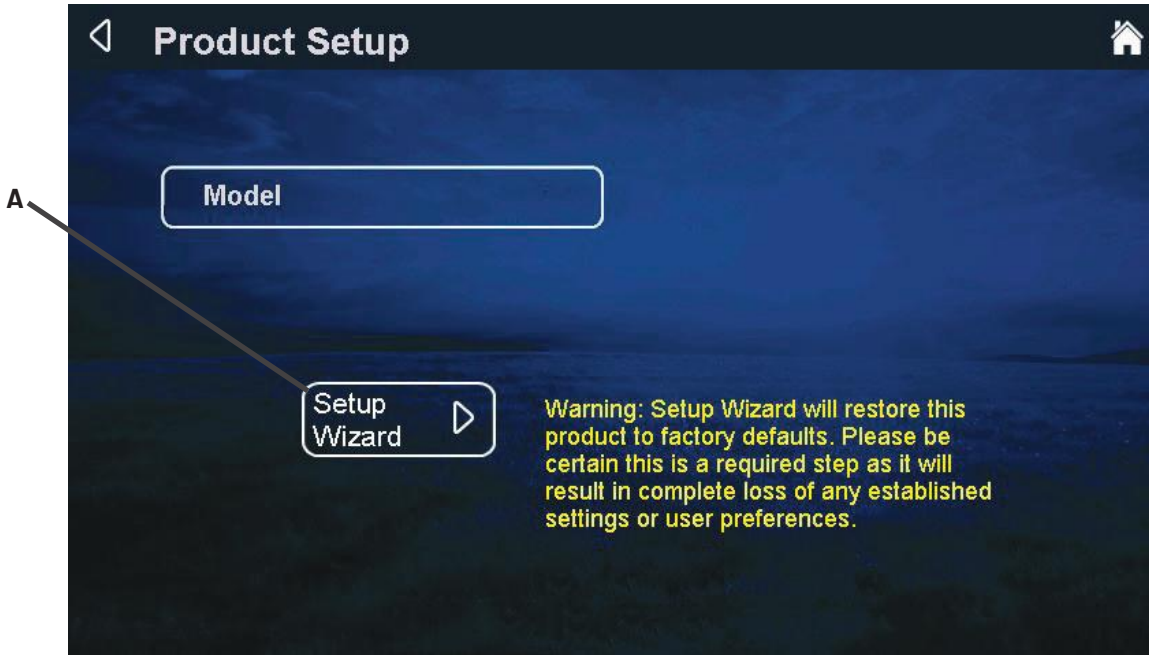

Utilities Menu - Software Update

TRUE may periodically release software updates to ensure users enjoy the best workout experience available. Due to the complex nature of this procedure, it is recommended that any software update be completed by a TRUE certified service professional.

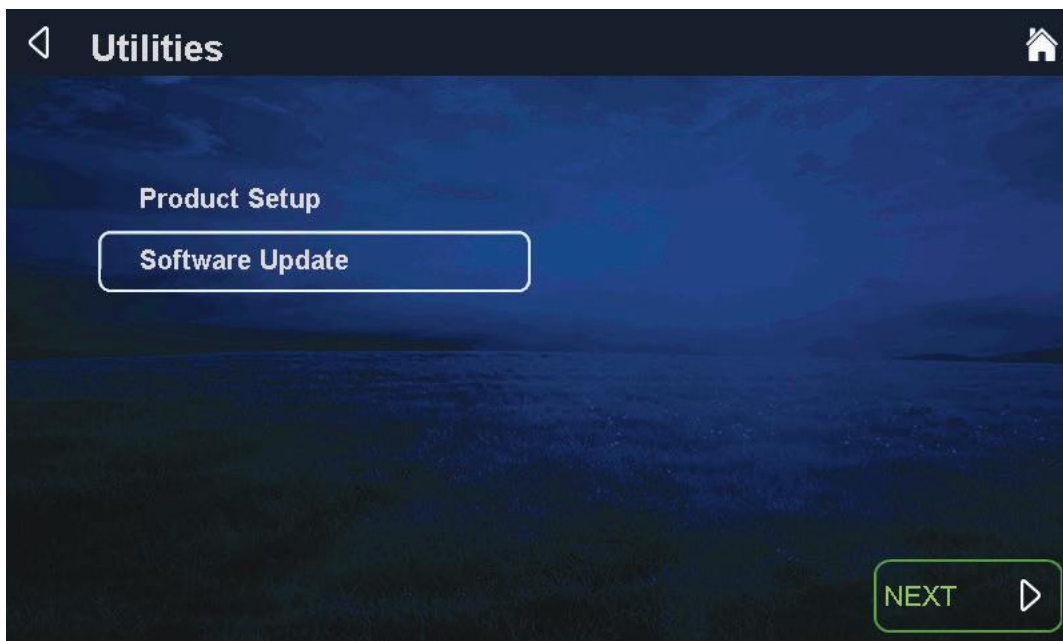

ADVANCED CONSOLE FUNCTIONS

Options Menu

The Options menu contains various options and settings that pertain to the operation and setup of the machine. Select the option to change and use the keypad to make changes.

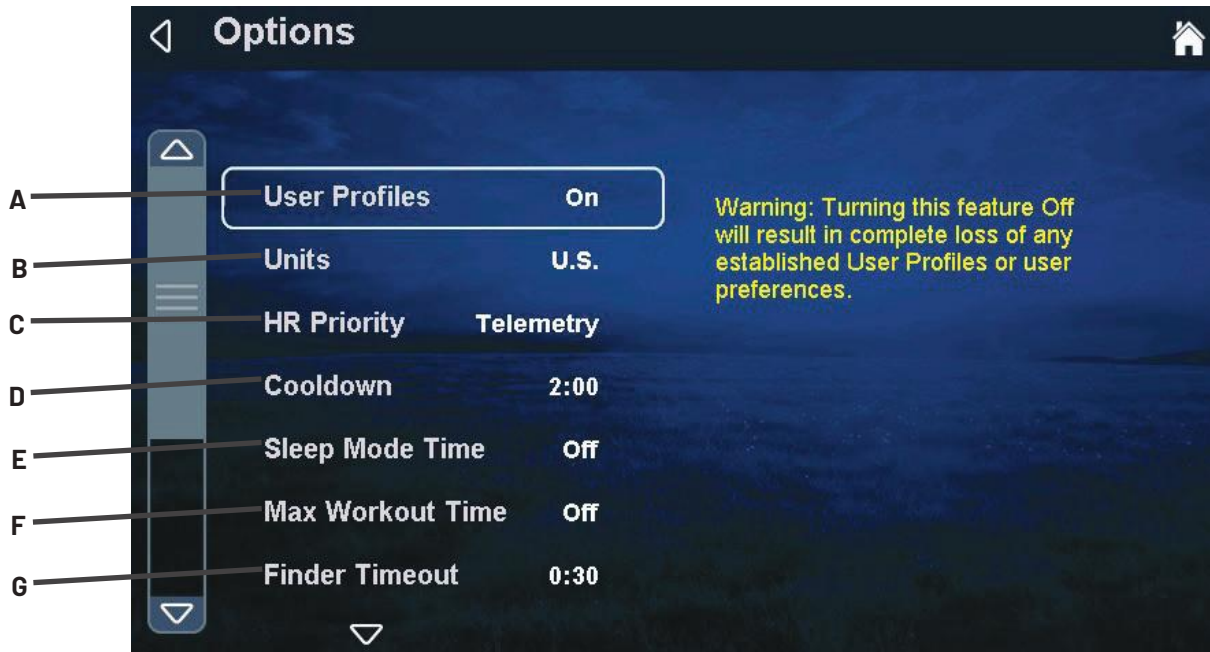

A. User Profiles

Enables or disables the Custom User Profile feature.

B. Units

Choose how the workout data is displayed by default.

C. HR Priority

Determines the order in which the unit reads heart rate data.

D. Cooldown

Adjusts the length of the cooldown time at the end of a workout.

E. Sleep Mode Timer

The amount of time the unit can be idle before entering Sleep Mode. By choosing the **Off** setting, the unit will remain powered.

F. Max Workout Time

Limits the amount of time that all workouts can last. By choosing the **Off** setting, the time will be unlimited (does not apply to manual or distance workouts).

G. Finder Timeout

Choose how long the Workout Finder remains on the screen without any user interaction. By choosing the **Off** setting, the workout finder will stay open until closed by a user.

H. Setup Timeout (Not Pictured)

Choose how long the Workout Data Entry screen will remain on the display without any user interaction. By choosing the **Off** setting, the data entry screen will be displayed until closed by a user.

I. Summary Timeout (Not Pictured)

Determines the amount of time the Workout Summary Screen will be displayed. By choosing the **Off** setting, the summary will be displayed until ended by a user.

J. Pause Time (Not Pictured)

Limits the amount of time that a workout can be paused before it automatically ends. By choosing the **Off** setting, the unit will remain paused until the user resumes or ends the workout.

K. Factory Defaults (Not Pictured)

Resets all settings to the factory defaults.

ADVANCED CONSOLE FUNCTIONS

Diagnostics Menu - Calibration/Test

This menu contains tools for testing and verifying machine operation on applicable machines.

NOTE: The image below may differ slightly based on the base unit used.

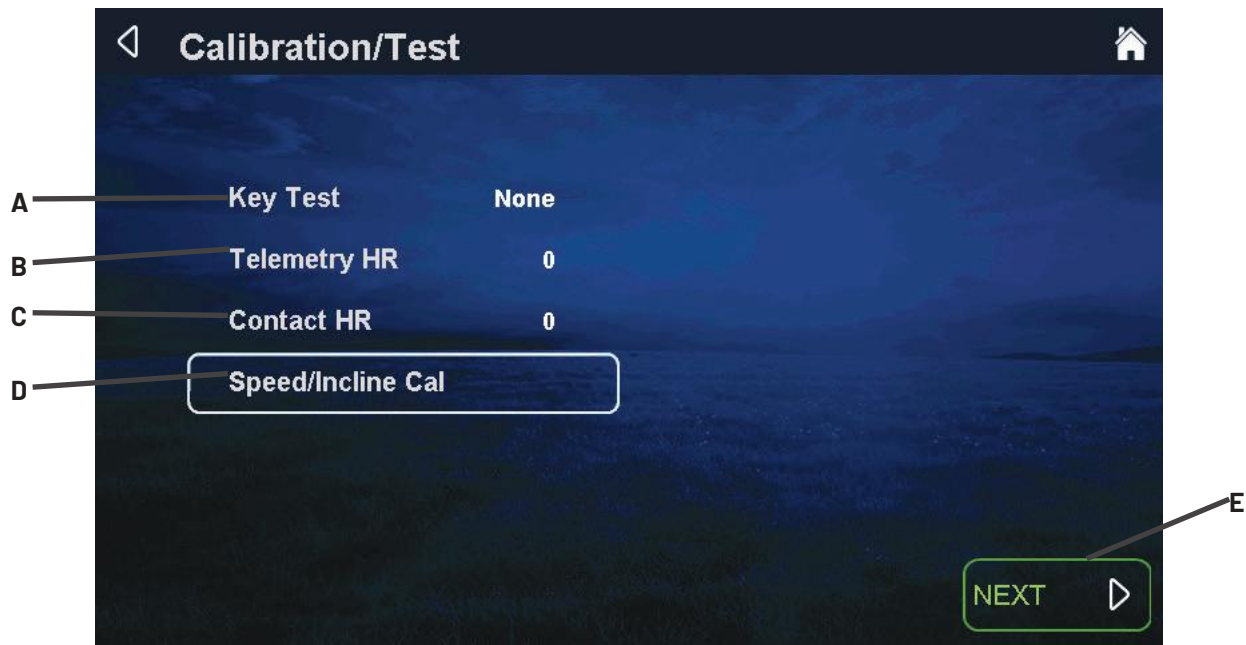

A. Key Test

When a key is pressed on the console **NONE** will change to indicate which key is being pressed. In the event of a stuck key, the key that is being engaged will display.

B. Telemetry HR

Use the supplied wireless heart rate strap or simulator to test if the unit is receiving wireless heart rate data. If there is a reading displayed without the use of a heart rate strap or simulator, there is outside interference from another source.

C. Contact HR

Ensures the unit is receiving the data by displaying the user's heart rate when the contact heart rate pads are gripped.

D. Speed/Incline Cal

Speed/Incline Cal (calibration) is selected by default in this menu on applicable machines. To run a calibration press **NEXT** (E) and follow the on-screen instructions.

⚠ WARNING: This process will take full control of the machine and can be dangerous if caution is not taken.

- Calibration can take up to two minutes to complete.
- Do not stand on the machine during the calibration procedure.
- Verify that the machine is free of all parts and tools.
- Keep children and animals at a safe distance.

Diagnostics Menu - Production Test

The Production Test screen is used during the production process and is not used for service or troubleshooting.

ADVANCED CONSOLE FUNCTIONS

Diagnostics Menu - Error Log

Error codes are an important part of troubleshooting any issues with the machine. Any time an error occurs it is entered into the Error Log for review by a service professional. This console is capable of storing the ten most recent errors. The error log can be cleared by pressing **NEXT** (A), but it is not recommended.

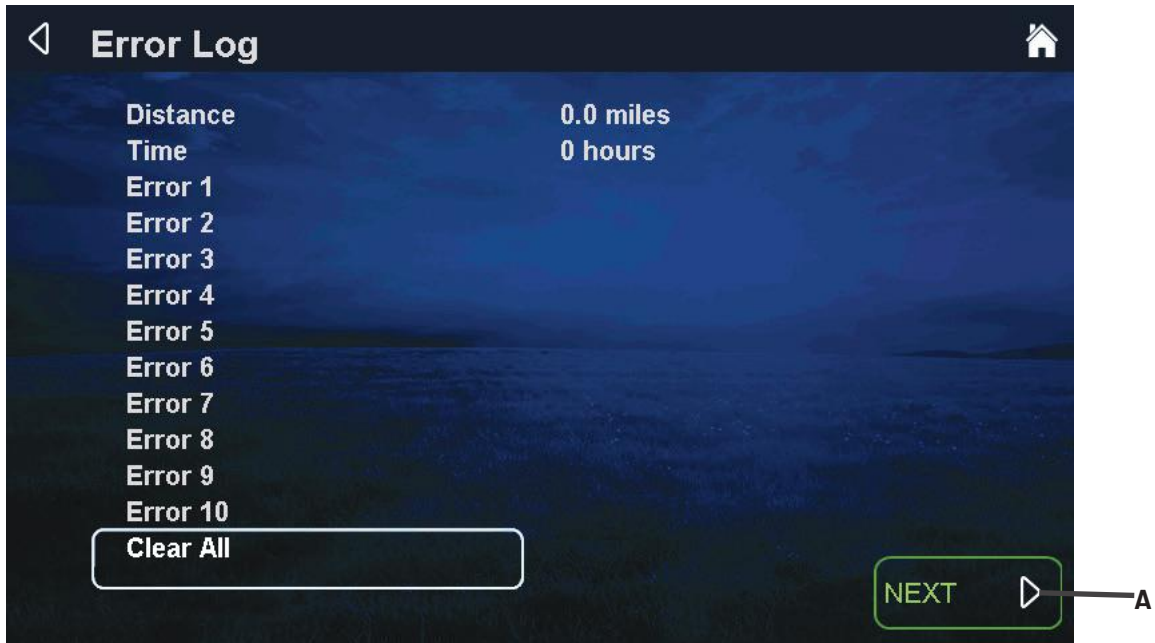

Statistics

The statistics menu displays an overview of the machine's running data.

NOTE: The specific statistics shown below will vary based on the base unit used.



WARRANTY

IN HOME RESIDENTIAL LIMITED WARRANTY

Warranty does not cover damage or equipment failure resulting from or caused by improper assembly/installation, accident, misuse, abuse, unauthorized modification, or failure to provide reasonable and necessary maintenance.

See the base manual or visit the TRUE website for the warranty duration for this product.

All TRUE Fitness products are distributed by TRUE and are warranted to the original registered product purchaser and the parts of the TRUE product (the "Product") listed below, under normal use and service, shall be free of manufacturing defects in workmanship and materials only for the specified period of time.

NOTE:

- Standard shipping is included with warranty part replacement.
- Shipping for warranty frame or replacement is included for the period of three years from the original date of purchase.

All Warranty Items are "LIMITED"

- This limited warranty does not cover damage or equipment failure resulting from or caused by improper assembly/installation, failure to follow instructions and warnings in owner's manual, accident, misuse, abuse, unauthorized modification, failure to provide reasonable and necessary maintenance, software version upgrades, compatibility with third party/aftermarket hardware, software, applications, or websites.
- TRUE's liability shall under no circumstances exceed the actual amount paid by you for the product, nor shall TRUE under any circumstances be liable for any consequential, incidental, special or punitive damages or losses, whether direct or indirect.
- Some states or countries do not allow the exclusion or limitation of incidental or consequential damages, so the above limitation or exclusion may not apply to you.
- TRUE will neither assume nor authorize any person to assure for us any other obligation or liability concerning the sale of this Product. Under no circumstances shall TRUE be liable under this warranty, or otherwise, of any damage to any person or property, including any lost profits or lost savings, for any special, indirect, secondary, incidental, or consequential damages arising out of the use of or inability to use this Product.
- This limited warranty, which is given expressly and in lieu of all other express warranties, constitutes the only warranty made by TRUE.

- The remedies described herein are your sole and exclusive remedies and TRUE's entire liability for any breach of this limited warranty.
- No one is authorized to change, modify, or extend the terms of this limited warranty.
- This limited warranty is in lieu of all other warranties of any kind either expressed or including but not limited to implied warranties of merchant.
- This limited warranty applies to the product only while the product remains in the possession of the original purchaser and is not transferable.
- This limited warranty becomes VALID ONLY if the Product is initially assembled/installed by a TRUE authorized dealer/technician (if anyone other than a TRUE authorized dealer/technician initially assembles and installs the Product, this limited warranty will be void unless the written authorization of TRUE is first obtained).
- This limited warranty can be processed only if the warranty registration form is completed on-line; or if the form provided with equipment is filled in, signed by the original purchaser, and mailed to TRUE within 30 days of purchaser's receipt of this Product.
- All serial numbers must be intact on the Product for this limited warranty to be valid.
- Installation or download of any 3rd party or after-market products will result in voided warranty. This includes, but is not limited to, electrical and mechanical parts, software, or applications.
- TRUE will ship to an authorized service provider any new or rebuilt replacement part or component, or at our option, replace or refund the Product.
- Replacement parts are warranted for the remaining portion of the original warranty period.
- Proof/receipts of necessary maintenance may be required within 30 days of requested warranty part or service.
- This limited warranty does not apply to the performance of the heart rate accuracy will not be warranted as performance varies, based on user's physiology, age, method of use, and other external factors.

WARRANTY REGISTRATION

Thank you for purchasing a TRUE product!

To validate your product warranty, you must register your product within 30 days of purchaser's receipt of this product.

To register your product:

- Go online to:
<https://shop.truefitness.com/resources/warranty/>
OR
- Complete the information below and mail to:
TRUE Product Support
865 Hoff Road
St. Louis, MO 63366

PLEASE RETAIN THIS PORTION FOR YOUR RECORDS
BASE SERIAL NUMBER:
CONSOLE SERIAL NUMBER:

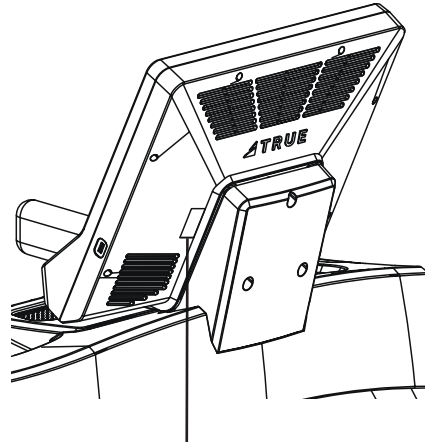

24-000000X

console serial
number location



Warranty Registration

Base Serial Number

Console Serial Number (if applicable)

NOTE: Some base units require a console serial number.

Purchase Date

Company (if applicable)

Customer Name (First and Last)

Email Address

Phone Number

Street Address

City

State

Postal Code

Country



CONTACT US
service@truefitness.com
1.800.883.8783

865 Hoff Road
St. Louis, MO 63366

[TRUEFITNESS.COM](https://www.truefitness.com)



MAN-C4RT9 Owner's Manual, Assembly Guide, and Warranty Card
REV03

© 2024 TRUE Fitness All Rights Reserved.