



7-INCH AUDIO/VIDEO RECEIVER

iLX-W770

EN

FR

ES



QUICK REFERENCE GUIDE
GUIDE DE RÉFÉRENCE RAPIDE
GUÍA DE REFERENCIA RÁPIDA

Please register your product at www.alpine-usa.com/registration to protect your purchase.
Enregistrez-vous sur www.alpine-usa.com/registration pour protéger votre achat.
Registre su producto en la dirección www.alpine-usa.com/registration para proteger su compra.

About the Rules of Bluetooth Electromagnetic Radiation Regulation

USA/Canada	<p>FCC/IC CAUTION</p> <p>This device complies with Industry Canada's licence-exempt RSSs. Operation is subject to the following two conditions:</p> <ol style="list-style-type: none">(1) This device may not cause interference; and(2) This device must accept any interference, including interference that may cause undesired operation of the device. <p>Changes or modifications not expressly approved by the party responsible for compliance could void the user's authority to operate the equipment.</p> <p>This equipment complies with FCC/IC radiation exposure limits set forth for an uncontrolled environment and meets the FCC radio frequency (RF) Exposure Guidelines and RSS-102 of the IC radio frequency (RF) Exposure rules. This equipment has very low levels of RF energy that it deemed to comply without maximum permissive exposure evaluation (MPE). But it is desirable that it should be installed and operated keeping the radiator at least 20 cm or more away from person's body.</p>
	<p>Le présent appareil est conforme aux CNR d'Industrie Canada applicables aux appareils radio exempts de licence.</p> <p>L'exploitation est autorisée aux deux conditions suivantes :</p> <ol style="list-style-type: none">(1) l'appareil ne doit pas produire de brouillage;(2) l'utilisateur de l'appareil doit accepter tout brouillage radioélectrique subi, même si le brouillage est susceptible d'en compromettre le fonctionnement. <p>Cet équipement est conforme aux limites d'exposition aux rayonnements énoncées pour un environnement non contrôlé et respecte les règles des radioélectriques (RF) de la FCC lignes directrices d'exposition et d'exposition aux fréquences radioélectriques (RF) CNR-102 de l'IC. Cet équipement émet une énergie RF très faible qui est considérée conforme sans évaluation de l'exposition maximale autorisée (MPE). Cependant, il est souhaitable qu'il devrait être installé et utilisé en gardant une distance de 20 cm ou plus entre le radiateur et le corps humain.</p>

Contents

WARNING	2
CAUTION	3
Getting Started	4
Apple CarPlay Operation (Optional).....	6
Android Auto™ (Optional).....	6
Radio Operation	7
USB Flash drive Operation (Optional).....	7
SiriusXM® Satellite Radio Operation (Optional)	8
iPod mode on iPhone (Optional).....	9
Hands-Free Phone Control	10
Camera Operation (Optional)	11
Installation.....	12
Connections.....	14
Specifications	16

IMPORTANT

Please record the serial number of your unit in the space provided below and keep it as a permanent record.

SERIAL NUMBER: _____

INSTALLATION DATE: _____

INSTALLATION TECHNICIAN: _____

PLACE OF PURCHASE: _____

For details on all functions, refer to the Owner's Manual published on our website at <http://www.alpine-usa.com>. If required, an ALPINE dealer will readily provide you with a print out of the Owner's Manual published on the website.

WARNING



WARNING

This symbol means important instructions. Failure to heed them can result in serious injury or death.

INSTALL THE PRODUCT CORRECTLY SO THAT THE DRIVER CANNOT WATCH TV/VIDEO UNLESS THE VEHICLE IS STOPPED AND THE EMERGENCY BRAKE IS APPLIED.

It is dangerous for the driver to watch TV/Video while driving a vehicle. Installing this product incorrectly enables the driver to watch TV/Video while driving. This may cause a distraction, preventing the driver from looking ahead, thus causing an accident. The driver or other people could be severely injured.

DO NOT WATCH VIDEO WHILE DRIVING.

Watching the video may distract the driver from looking ahead of the vehicle and cause an accident.

DO NOT OPERATE ANY FUNCTION THAT TAKES YOUR ATTENTION AWAY FROM SAFELY DRIVING YOUR VEHICLE.

Any function that requires your prolonged attention should only be performed after coming to a complete stop. Always stop the vehicle in a safe location before performing these functions. Failure to do so may result in an accident.

KEEP THE VOLUME AT A LEVEL WHERE YOU CAN STILL HEAR OUTSIDE NOISES WHILE DRIVING.

Excessive volume levels that obscure sounds such as emergency vehicle sirens or road warning signals (train crossings, etc.) can be dangerous and may result in an accident. LISTENING AT LOUD VOLUME LEVELS IN A CAR MAY ALSO CAUSE HEARING DAMAGE.

MINIMIZE DISPLAY VIEWING WHILE DRIVING.

Viewing the display may distract the driver from looking ahead of the vehicle and cause an accident.

DO NOT DISASSEMBLE OR ALTER.

Doing so may result in an accident, fire or electric shock.

USE ONLY IN CARS WITH A 12 VOLT NEGATIVE GROUND.

(Check with your dealer if you are not sure.) Failure to do so may result in fire, etc.

KEEP SMALL OBJECTS SUCH AS SCREWS OUT OF THE REACH OF CHILDREN.

Swallowing them may result in serious injury. If swallowed, consult a physician immediately.

USE THE CORRECT AMPERE RATING WHEN REPLACING FUSES.

Failure to do so may result in fire or electric shock.

DO NOT BLOCK VENTS OR RADIATOR PANELS.

Doing so may cause heat to build up inside and may result in fire.

USE THIS PRODUCT FOR MOBILE 12V APPLICATIONS.

Use for other than its designed application may result in fire, electric shock or other injury.

MAKE THE CORRECT CONNECTIONS.

Failure to make the proper connections may result in fire or product damage.

BEFORE WIRING, DISCONNECT THE CABLE FROM THE NEGATIVE BATTERY TERMINAL.

Failure to do so may result in electric shock or injury due to electrical shorts.

DO NOT ALLOW CABLES TO BECOME ENTANGLED IN SURROUNDING OBJECTS.

Arrange wiring and cables in compliance with the manual to prevent obstructions when driving. Cables or wiring that obstruct or hang up in places such as the steering wheel, gear lever, brake pedals, etc. can be extremely hazardous.

DO NOT SPLICE INTO ELECTRICAL CABLES.

Never cut away cable insulation to supply power to other equipment. Doing so will exceed the current carrying capacity of the wire and result in fire or electric shock.

DO NOT DAMAGE PIPE OR WIRING WHEN DRILLING HOLES.

When drilling holes in the chassis for installation, take precautions so as not to contact, damage or obstruct pipes, fuel lines, tanks or electrical wiring. Failure to take such precautions may result in fire.

DO NOT USE BOLTS OR NUTS IN THE BRAKE OR STEERING SYSTEMS TO MAKE GROUND CONNECTIONS.

Bolts or nuts used for the brake or steering systems (or any other safety-related system), or tanks should NEVER be used for installations or ground connections. Using such parts could disable control of the vehicle and cause fire etc.

DO NOT INSTALL IN LOCATIONS WHICH MIGHT HINDER VEHICLE OPERATION, SUCH AS THE STEERING WHEEL OR GEARSHIFT.

Doing so may obstruct forward vision or hamper movement etc. and results in serious accident.

**CAUTION**

This symbol means important instructions. Failure to heed them can result in injury or material property damage.

HALT USE IMMEDIATELY IF A PROBLEM APPEARS.

Failure to do so may cause personal injury or damage to the product. Return it to your authorized Alpine dealer or the nearest Alpine Service Center for repairing.

HAVE THE WIRING AND INSTALLATION DONE BY EXPERTS.

The wiring and installation of this unit requires special technical skill and experience. To ensure safety, always contact the dealer where you purchased this product to have the work done.

USE SPECIFIED ACCESSORY PARTS AND INSTALL THEM SECURELY.

Be sure to use only the specified accessory parts. Use of other than designated parts may damage this unit internally or may not securely install the unit in place. This may cause parts to become loose resulting in hazards or product failure.

ARRANGE THE WIRING SO IT IS NOT CRIMPED OR PINCHED BY A SHARP METAL EDGE.

Route the cables and wiring away from moving parts (like the seat rails) or sharp or pointed edges. This will prevent crimping and damage to the wiring. If wiring passes through a hole in metal, use a rubber grommet to prevent the wire's insulation from being cut by the metal edge of the hole.

DO NOT INSTALL IN LOCATIONS WITH HIGH MOISTURE OR DUST.

Avoid installing the unit in locations with high incidence of moisture or dust. Moisture or dust that penetrates into this unit may result in product failure.

Getting Started

Controls Position

The screen design used in the Quick Reference Guide may differ from the actual screen.

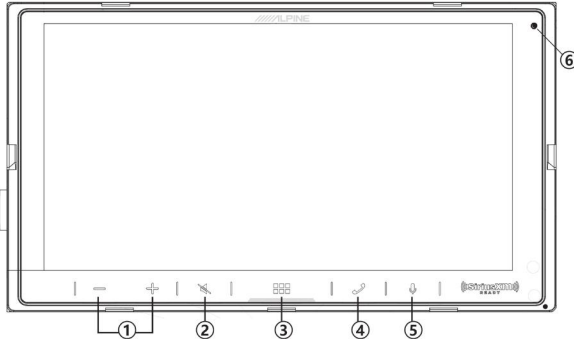

- ① **— / + (DOWN/UP) button**
 Touch to adjust the volume.
 Touch and hold this button for at least 1.7 second to adjust the volume to maximum or minimum.
- ② **🔇 (MUTE) button**
 Touch to activate/deactivate the mute mode.
 Touch and hold this button for at least 1.7 second to display on/off.
- ③ **🏠 (HOME)/(Power Off) button**
 Activates the HOME screen.
 Touch and hold this button for at least 1.7 second to turn the power off.
- ④ **📞 (Phone) button**
 Activates the Phone screen.
- ⑤ **🎤 button**
 When phone is connected to CarPlay, touch this button to activate Siri.
 When phone is connected to Android Auto, touch this button to activate VR.
 When Siri is activated, the function of Siri is available
 When VR is activated, the VR setting is ON and the function of VR is available.
 When the CarPlay/Android Audio is disconnected, the operation in this button is invalidate.
 When CarPlay/Android Audio is disconnected, touch and long hold to enter into the Device Searching List to activate the new device searching.
- ⑥ **(Reset) button**
 Reset & Restart.

Turning Power On or Off

1 Turn the ignition key to the ACC or ON position.

The system is turned on.

2 Touch and hold the (HOME) button for at least 1.7 seconds to turn the power off.

- When the system is used for the first time, the language selection menu is displayed. Select the desired language, and then touch [OK].

About the HOME Screen

Select a widget on the HOME screen to perform various settings and operations of the function.

1 Touch the (HOME) button.

The HOME screen is displayed.

■ HOME screen example

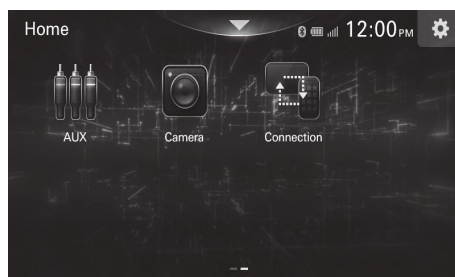
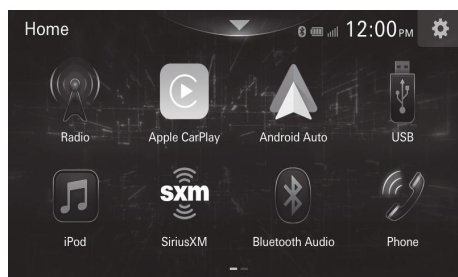

Radio	Displays the Radio main screen.
Apple CarPlay	You can use Apple CarPlay. <ul style="list-style-type: none">• If compatible iPhone is not connected to usb, this widget is not available.
Android Auto	You can use Android Auto. <ul style="list-style-type: none">• If compatible Android phone is not connected to usb, this widget is not available.
USB	You can play back music files, video files and photo files stored in a USB flash drive. <ul style="list-style-type: none">• If a USB flash drive is not connected, this widget is not available.
iPod	Displays the iPod main screen. <ul style="list-style-type: none">• If an iPhone is not connected, this widget is not available.
SiriusXM	Displays the SiriusXM main screen. <ul style="list-style-type: none">• If a SiriusXM Tuner (Optional) is not connected, this widget is not available.
Bluetooth Audio	Displays the Bluetooth audio main screen.
Phone	Displays the Phone main screen.
AUX	Displays the AUX main screen. <ul style="list-style-type: none">• If there is no input signal on AUX, it will be a black screen.
Camera	Displays the Camera main screen. <ul style="list-style-type: none">• If there is no input signal on Camera, it will be a black screen.
Connection	Displays the status of the connected devices.

Apple CarPlay Operation (Optional)

Apple CarPlay is a smarter, safer way to use your iPhone in the car. Apple CarPlay takes the things you want to do with your iPhone while driving and puts them right on this unit. You can get directions, make calls, send and receive messages, and listen to music, all in a way that allows you to stay focused on the road. Just plug in your iPhone to this unit and go.

Access to wired Apple CarPlay

- 1 Plug in your iPhone using Lightning to USB Cable (Supplied with iPhone) to the unit.**
- 2 Touch the  (HOME) button.**
The HOME screen is displayed.
- 3 Touch [Apple CarPlay].**
The Apple CarPlay screen is displayed.

Access to wireless Apple CarPlay

- 1 Touch [Connection] button**
- 2 Taas to enter [Search] screen to search for devices.**
- 3 Select a device and follow the on-screen prompts to connect devices.**
- 4 Select the iPhone you want to connect and it will go to CarPlay screen after you select.**

- Refer to "Apple CarPlay" in the Owner's Manual for information on how to operate Apple CarPlay.

Android Auto™ Operation (Optional)

Android Auto is designed to make it easier to use apps from your phone while you're on the road. Navigate with Google Maps, listen to Playlists or Podcasts from your favorite apps, send messages via voice, and more. Download the Android Auto App from the Google Play Store before continuing.

- Download the Android Auto App from the Google Play Store before continuing.

Access to wired Android Auto

Just plug in your smartphone to the unit's USB connector, then follow the prompt to pair your smartphone with the unit.

- 1 Touch the  (HOME) button.**
The HOME screen is displayed.
- 2 Touch [Android Auto].**
The Android Auto screen is displayed.

Access to wireless Android Auto

- 1 Touch [Connection] button**
- 2 Touch [Q] to enter [Search] screen to search for devices.**
- 3 Select a device and follow the on-screen prompts to connect devices.**
- 4 Select the Phone you want to connect and it will go to Android Auto screen after you select.**

- Refer to "Android Auto" in the Owner's Manual for information on how to operate Android Auto.

Radio Operation

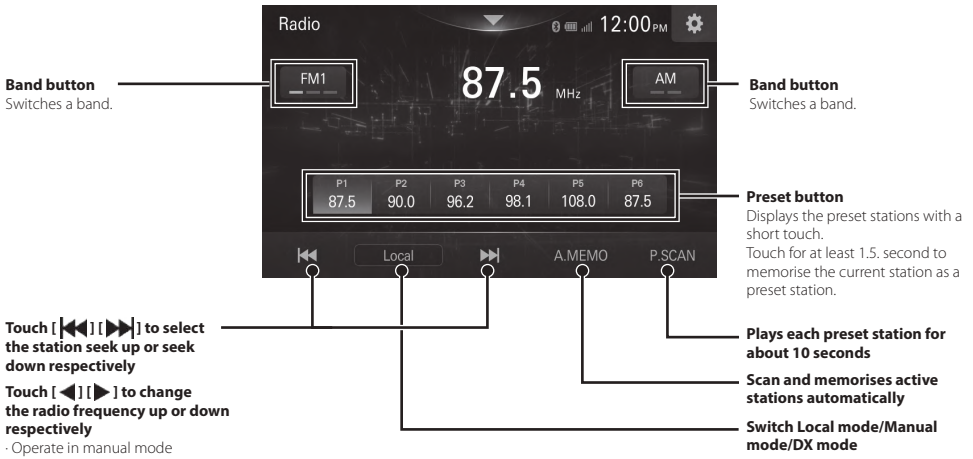

- The patterns of some keys in the Quick Reference Guide may differ from the actual screen.

USB Flash drive Operation (Optional)

You can play back music files (WAVE,WMA,AAC,MP3,OGG,FLAC,APE), video files (AVI, MPEG 1/2, MPEG4, WMV, Flash, QuickTime, ASF, Matroska Video, TS Stream, 3GP) and photo files (JPG, JPEG, PNG, BMP) stored in a USB flash drive on the internal player of this system.

USB Audio main screen example

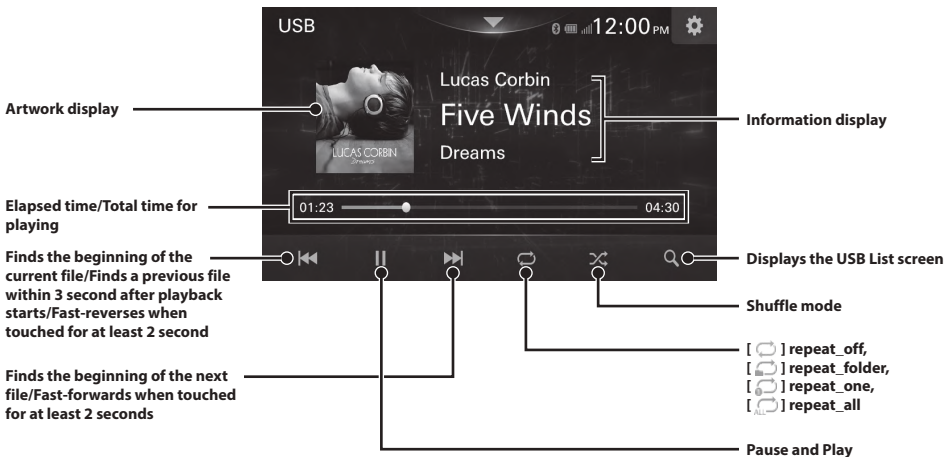

- The patterns of some keys in the Quick Reference Guide may differ from the actual screen.

SiriusXM® Satellite Radio Operation (Optional)

When an optional SiriusXM Tuner is connected to this unit, the following operations may be performed.

SiriusXM main screen example

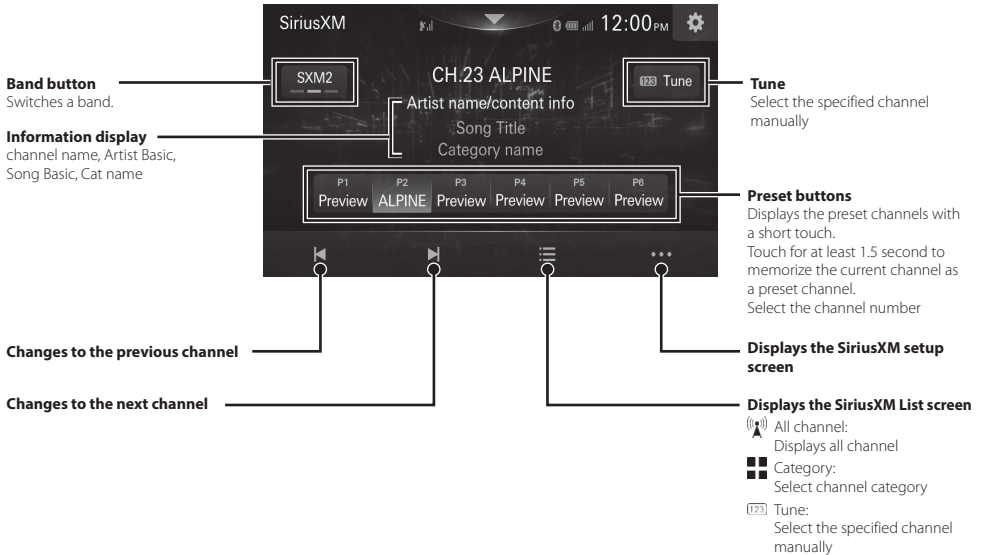

- The patterns of some keys in the Quick Reference Guide may differ from the actual screen.

iPod mode on iPhone (Optional)

Before using this function, plug in your iPhone using a Lightning-USB cable (supplied with iPhone) to the unit.

The following devices have been tested and shown to work with this unit. Correct function of earlier versions cannot be guaranteed.

iPhone 15 Pro Max, iPhone 15 Pro, iPhone 15 Plus, iPhone 15, iPhone 14 Pro Max, iPhone 14 Pro, iPhone 14 Plus, iPhone 14, iPhone SE (3rd generation), iPhone 13 Pro Max, iPhone 13 Pro, iPhone 13 mini, iPhone 12 Pro Max, iPhone 12 Pro, iPhone 12, iPhone 12 mini, iPhone SE (2nd generation), iPhone 11 Pro Max, iPhone 11 Pro, iPhone 11, iPhone XS Max, iPhone XS, iPhone XR, iPhone X, iPhone 8 Plus, iPhone 8, iPhone 7 Plus, iPhone 7, iPhone SE, iPhone 6s Plus, iPhone 6s, iPhone 6 Plus, iPhone 6

iPod main screen example

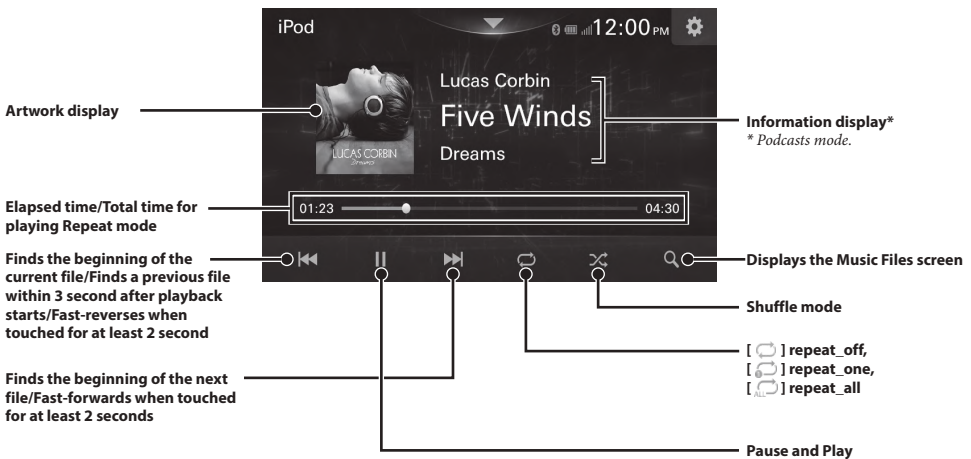

Searching for a Music File

For example: Searching by Artist name

1 Touch [Q (Search)] during playback.

2 Touch [Artists].

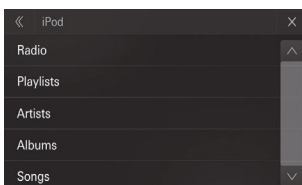

3 Touch the desired artist's name.

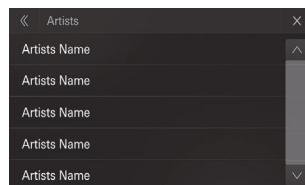

4 Touch the desired album's name.

5 Touch the desired song's name.

The selected song is played back.

Hands-Free Phone Control

The unit can connect with up to two hands-free phones.

How to connect to a Bluetooth compatible device (Pairing)

To display the Setup HOME screen:

1. Bring your vehicle to a complete stop at a safe location.
Engage the parking brake.
2. Release the parking brake. (For safety, release the parking brake while depressing the foot brake pedal).
3. Engage the parking brake again.
 - For automatic transmission vehicles, place the transmission lever in the Park position.

1 Touch the (HOME) button.

The HOME screen is displayed.

2 Touch [Bluetooth Audio].

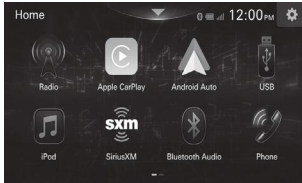

3 Touch [].



4 Touch [(Search)] to search for a new device.

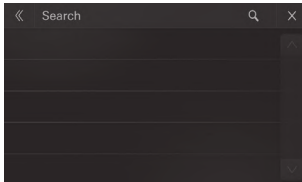

5 Touch the device you want to connect from the list.

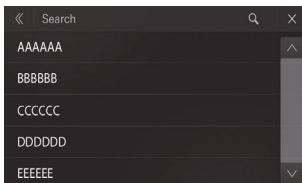

6 The device registration is complete.

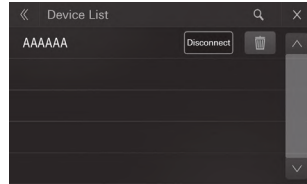

- You can register up to 5 Bluetooth compatible mobile phones.
- The Bluetooth registration process differs depending on the device version and SSP (Simple Secure Pairing). If a 4 or 6 character Numeric Comparison appears on this system, enter the Numeric Comparison on the Bluetooth device.
- If a 6 character Passkey appears on this system, make sure the same passkey is displayed on the Bluetooth device, and follow the screen.

Phone menu screen example

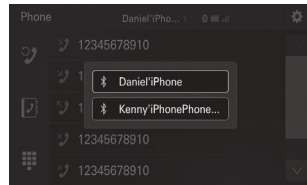

Phone selection

You can select which phone to display after connecting two phones.

Answering a Call

- 1 **An incoming call triggers the ringtone and an incoming call display.**

Phone incoming screen example

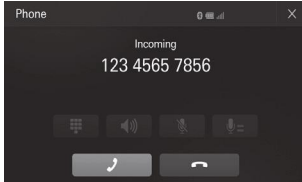

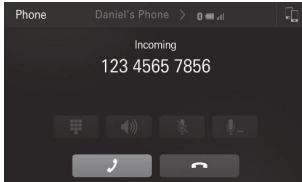

Two phones incoming screen example

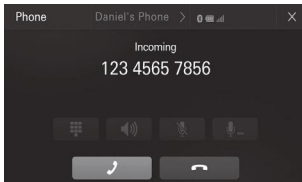

Touch [] to select which incoming call you want to answer.

When the unit is answering, another phone incoming screen example



Touch [] to close the incoming screen without ending the call.

- 2 **Touch [] (Call).**

The call starts.

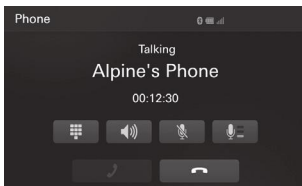

Hanging up the Telephone

- 1 **Touch [] (End Call).**

The call finishes.

Calling

Entering a Phone Number to Make a Call

- 1 **Touch [] [Keypad].**

The number input screen (Keypad) appears.

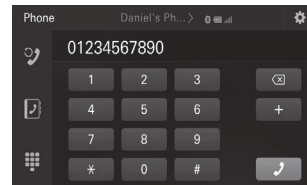

Touch [] to delete an entered number.

- 2 **Enter the phone number you wish to call.**

- You can enter up to 20 digits.

- 3 **Touch [] (Call).**

The phone call is started.

Making a phone call from the Recent Events list

- 1 **Touch [] to change to the Recent Events list screen.**

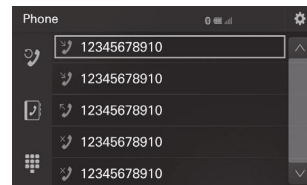

- 2 **Touch the name of the contact or number you want to call.**

The phone call is started.

Calling from the Contacts list (Phone Book)

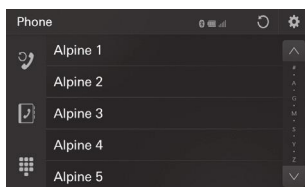

1 Touch [📇] to change to the Contacts list screen.

2 Touch the name of the contact or number you want to call.

3 Touch the phone number.

The Phone Operation screen is displayed.

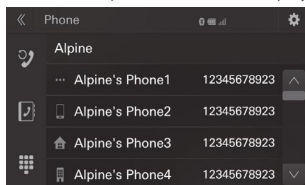

4 Touch the number you want to call.

The phone call is started.

Camera Operation (Optional)

Displaying the Camera Image from the Menu screen

When an optional camera is connected, the view of camera video can be output to the monitor.

The unit has two camera inputs, rear camera, Front camera (or Side camera, etc.) can be connected to this unit.

1 Touch the (HOME) button.

The HOME screen is displayed.



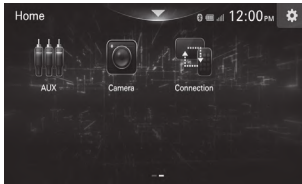

2 Touch [Camera].

Touch the screen while the camera image is being displayed, and touch  to return to the main source screen or previous screen.



Camera screen example



-  Camera screen close
-  /  Change the caution display location
-  Guide display on/off
-  Select Camera Input

Installation

Note on installation

- Install at an angle between horizontal and 30°. Note that installing at an angle outside of this range will result in a loss of performance and possible damage.

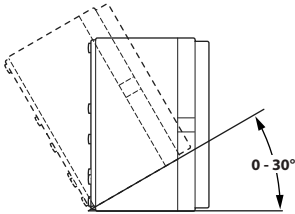

- Do not block the unit's heat sink, which would prevent air circulation. If blocked, heat will accumulate inside the unit and may cause a fire.

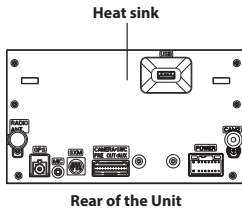

Mounting the Microphone

For safe use, make sure of the following:

- Location is stable and firm.
- Driver's view and operations are not obstructed.
- Microphone is located where the driver's voice can be easily picked up (on the sun visor, etc.).

When you speak into the microphone, you should not have to change your driving posture. This may cause a distraction, taking your attention away from safely driving your vehicle. Carefully consider direction and distance while mounting the microphone. Confirm that the driver's voice can be easily picked up at the selected location.

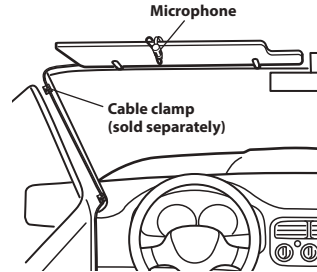

Installing the Unit

- 1 Mount the original mounting bracket to the unit using the supplied screws.**

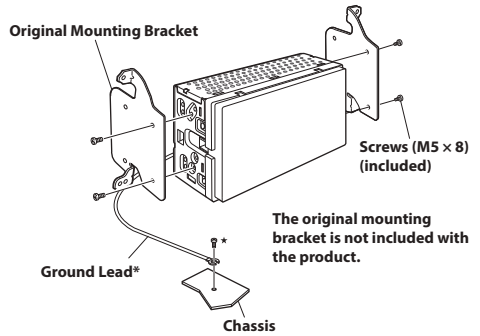

- 2 Connect all other leads of the unit according to details described in the "Connections" (page 16).**

- 3 Mounting the unit in a car.**

- * To securely connect the ground lead, use an already installed screw on a metal part of the vehicle (marked ★) or a clean, bare metal spot on the vehicle's chassis.
- Fix the cables carefully. Do not damage them by tucking them into movable parts, such as a seat rail, or by locating them against sharp or pointed edges.

Connection Diagram of SPST Switch (sold separately)

(If the ACC power supply is not available)

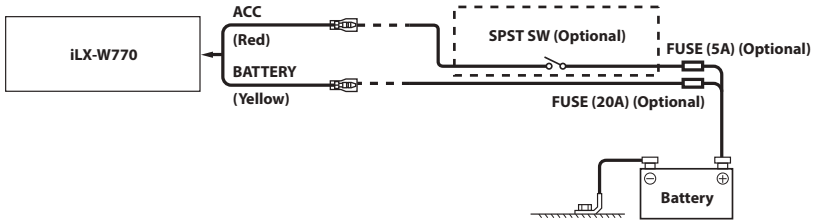

- If your vehicle has no ACC power supply, add an SPST (Single-Pole, Single-Throw) switch (sold separately) and fuse (sold separately).
- The diagram and the fuse amperage shown above are in the case when iLX-W770 is used individually.
- If the switched power (ignition) lead of the iLX-W770 is connected directly to the positive (+) post of the vehicle's battery, the iLX-W770 draws some current (several hundred milliamperes) even when its switch is placed in the OFF position, and the battery may be discharged.

Connections

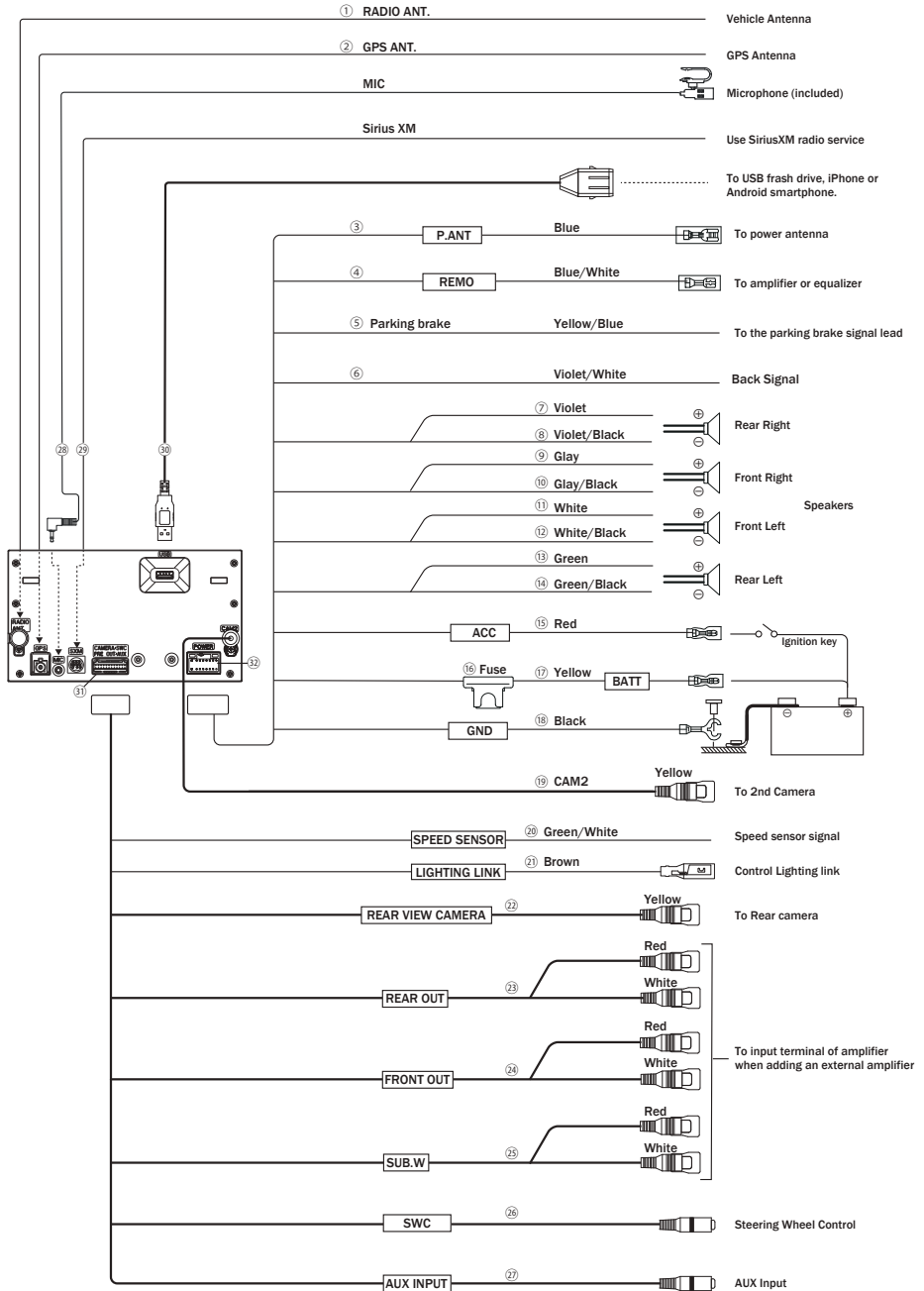

- ① **Radio Antenna Receptacle**
- ② **GPS Antenna Receptacle**
- ③ **Power Antenna Lead (Blue)**
Connect this lead to the +B terminal of your power antenna, if applicable.
- This lead should be used only for controlling the vehicle's power antenna. Do not use this lead to turn on an amplifier or a signal processor, etc.
- ④ **Remote Turn-On Lead (Blue/White)**
Connect this lead to the remote turn-on lead of your amplifier or signal processor.
- ⑤ **Parking Brake Lead (Yellow/Blue)**
Connect this lead to the power supply side of parking brake switch to transmit the parking brake status signals to the unit.
- ⑥ **Reverse Lead (Violet/White)**
- ⑦ **Right Rear (+) Speaker Output Lead (Violet)**
- ⑧ **Right Rear (-) Speaker Output Lead (Violet/Black)**
- ⑨ **Right Front (+) Speaker Output Lead (Gray)**
- ⑩ **Right Front (-) Speaker Output Lead (Gray/Black)**
- ⑪ **Left Front (+) Speaker Output Lead (White)**
- ⑫ **Left Front (-) Speaker Output Lead (White/Black)**
- ⑬ **Left Rear (+) Speaker Output Lead (Green)**
- ⑭ **Left Rear (-) Speaker Output Lead (Green/Black)**
- ⑮ **Switched Power Lead (Ignition) (Red)**
Connect this lead to an open terminal on the vehicle's fuse box or another unused power source that provides (+) 12V only when the ignition is turned on or in the accessory position.
- ⑯ **Fuse Holder (15A)**
- ⑰ **Battery Lead (Yellow)**
Connect this lead to the positive (+) post of the vehicle's battery.
- ⑱ **Ground Lead (Black)**
Connect this lead to a good chassis ground on the vehicle. Make sure the connection is made to bare metal and is securely fastened using the sheet metal screw provided.
- ⑲ **CAM2 (Yellow)**
To 2nd CAMERA
- ⑳ **SPEED SENSOR(Green/White)**
- ㉑ **LIGHTING LINK(Brown)**
- ㉒ **REAR CAMERA Input RCA Connector(Black)**
Use when connecting a camera with RCA Output Connector.
- ㉓ **Rear Output RCA Connectors**
Can be used as Rear Output RCA Connectors. RED is right and WHITE is left.
- ㉔ **Front Output RCA Connectors**
Can be used as Front Output RCA Connectors. RED is right and WHITE is left.
- ㉕ **Subwoofer RCA Connectors**
- ㉖ **SWC**
Steering Wheel Control
- ㉗ **AUX INPUT (Black)**
Audio and video input.
- ㉘ **MIC Input Connector**
To microphone (included)
- ㉙ **SiriusXM Tuner Input Connector**
To SiriusXM Tuner (sold separately).
- For more information on how to install the SiriusXM Connect Vehicle tuner, consult the installation guide included with the tuner.
- ㉚ **USB Connector**
To USB flash drive, iPhone or Android smartphone.
- ㉛ **CAMERA/SWC PRE OUT/AUX**
- ㉜ **Power Supply Connector**

Specifications

MONITOR SECTION

Screen Size	6.75"
LCD Type	Normally white, Transmissive
Operation System	a-Si TFT active matrix
Number of Picture Elements	1 152 000 pcs. (800 × 480 × 3 (RGB))
Effective Number of Picture Elements	99% or more
Illumination System	LED

FM TUNER SECTION

Tuning Range	87.7 – 107.9 MHz
Mono Usable Sensitivity	<9 dBu (75 ohms)
50 dB Quieting Sensitivity	<5 dBu (75 ohms)

Signal-to-Noise Ratio	65 dB
Stereo Separation	35 dB

AM TUNER SECTION

Tuning Range	530 – 1,710 kHz
Usable Sensitivity	34 dBu

USB SECTION

USB requirements	USB 2.0
Max. Power Consumption	1,500 mA (CDP Support)
USB Class	USB (Play From Device)/ USB (Mass Storage Class)
File System	FAT16/32, NTFS
Number of Channels	2-Channels (Stereo)
Frequency Response ^{*1}	17 – 20,000 Hz (±1 dB)
Total Harmonic Distortion	0.05% (at 1 kHz)
Dynamic Range	90 dB (at 1 kHz)
Signal-to-Noise Ratio	85 dB
Channel Separation	75 dB (at 1 kHz)

*1 Frequency response may differ depending on the encoder software/bit rate.

Bluetooth SECTION

Bluetooth Specification	Bluetooth V5.0
Output Power	<+4dBm Ave. (Power class 2)
Profile	HFP (Hands-Free Profile) PBAP (Phone Book Access Profile) A2DP (Advanced Audio Distribution Profile) AVRCP (Audio/Video Remote Control Profile)

Wi-Fi SECTION

Wi-Fi Specification	Support IEEE 802.11a/n/ac
Model	Access point(AP)
Band	5G Hz

GENERAL

Power Requirement	14.4 V DC (10.8–16.0 V allowable)
Operating temperature	-4°F to +140°F (-20°C to + 60°C)
Power Output	16 W RMS × 4 ²

*2 Primary amplifier ratings per CEA-2006 Standard

- Power output: measured at 4 Ohms and ≤ 1% THD+N
- S/N: 80 dBA (reference: 1 W into 4 Ohms)

Weight	0.9 kg
Audio output level	
Preout (Front, Rear):	4V/10k ohms (max.)
Preout (Subwoofer):	4V/10k ohms (max.)

CHASSIS SIZE

Width	178 mm
Height	100 mm
Depth	68mm

- Due to continuous product improvement, specifications and design are subject to change without notice.
- The LCD panel is manufactured using an extremely high precision manufacturing technology. Its effective pixel ratio is over 99.99%. This means that there is a possibility that 0.01% of the pixels could be either always ON or OFF.

- Windows Media and the Windows logo are trademarks, or registered trademarks of Microsoft Corporation in the United States and/or other countries.
- Apple, iPhone, iPod, and Siri are trademarks of Apple Inc., registered in the U.S. and other countries. Apple CarPlay is a trademark of Apple Inc.
- Use of the Made for Apple and Works with Apple badges means that an accessory has been designed to connect specifically to the Apple product(s) identified in the Made for Apple badge and to work specifically with the technology identified in the Works with Apple badge, and has been certified by the developer to meet Apple performance standards. Apple is not responsible for the operation of this device or its compliance with safety and regulatory standards.
- Please note that the use of this accessory with an Apple product may affect wireless performance.
- Use of the Apple CarPlay logo means that a vehicle user interface meets Apple performance standards. Apple is not responsible for the operation of this vehicle or its compliance with safety and regulatory standards. Please note that the use of this product with iPhone may affect wireless performance.
- SiriusXM and all related marks and logos are trademarks of Sirius XM Radio Inc. All rights reserved.
- Google, Android, Android Auto, Google Play and other marks are trademarks of Google LLC.
- The Bluetooth® word mark and logos are registered trademarks owned by the Bluetooth SIG, Inc. and any use of such marks by Alpine Electronics, Inc. is under license.
- MPEG Layer-3 audio coding technology licensed from Fraunhofer IIS and Thomson. Supply of this product only conveys a license for private, non-commercial use and does not convey a license nor imply any right to use this product in any commercial (i.e. revenue-generation) real time broadcasting (terrestrial, satellite, cable and/or any other media), broadcasting/streaming via internet, intranets and/or other networks or in other electronic content distribution systems, such as pay-audio or audio-on-demand applications. An independent license for such use is required. For details, please visit <http://www.mp3licensing.com>



GARANTIE LIMITÉE

Fidèle à son engagement de ne fournir que des produits de qualité, ALPINE ÉLECTRONIQUE DE L'AMÉRIQUE, INC. (« Alpine ») est heureuse de vous offrir cette garantie. Nous vous suggérons de le lire attentivement et en entier. Si vous avez la moindre question, veuillez contacter l'un de nos concessionnaires ou appeler directement Alpine aux numéros listés ci-dessous.

● PRODUITS COUVERTS PAR LA GARANTIE

Cette garantie couvre les produits audio de voiture et les accessoires connexes (« le produit »). Elle ne couvre les produits que dans le pays où ils ont été achetés.

● DURÉE DE LA GARANTIE

Cette garantie est en vigueur pendant un an à partir de la date du premier achat du client.

● PERSONNES PROTÉGÉES PAR LA GARANTIE

Seul l'acheteur original du produit, s'il réside aux États-Unis, à Porto Rico ou au Canada, peut se prévaloir de la garantie.

● CE QUI EST COUVERT

Cette garantie couvre tous les défauts de matériaux et de fabrication (pièces et main d'œuvre) du produit.

● CE QUI N'EST PAS COUVERT

Cette garantie ne couvre pas ce qui suit:

- ① Les dommages survenus durant le transport des produits renvoyés à Alpine pour être réparés (les réclamations doivent être adressées au transporteur);
 - ② Les dégâts provoqués par un accident ou une mauvaise utilisation, y compris des bobines acoustiques grillées suite à une surexcitation des enceintes (augmentation du niveau de l'amplificateur jusqu'à atteindre un effet de distorsion ou d'écrêtage), une défaillance mécanique des enceintes (perforations, déchirures ou fentes), panneau LCD fissurés ou endommagés, disques durs endommagés ou ayant subi une chute.
 - ③ Tout dégât provoqué par négligence, usage inapproprié, mauvaise utilisation ou par le non-respect des instructions indiquées dans le manuel de l'utilisateur.
 - ④ Les dommages dus à la force majeure, notamment aux tremblements de terre, au feu, aux inondations, aux tempêtes ou aux autres cataclysmes naturels; Les frais ou les dépenses relatifs à l'enlèvement ou à la réinstallation du produit;
 - ⑤ Les services rendus par une personne, physique ou morale non autorisée;
 - ⑥ Les produits dont le numéro de série a été effacé, modifié ou retiré;
 - ⑦ Les produits qui ont été adaptés ou modifiés sans le consentement d'Alpine;
 - ⑧ Les produits qui ne sont pas distribués par Alpine aux États-Unis, à Porto Rico ou au Canada;
 - ⑨ Les produits qui n'ont pas été achetés par l'entremise d'un concessionnaire Alpine autorisé;
- ### ● COMMENT SE PRÉVALOIR DE LA GARANTIE
- ① Il vous faut remettre le produit nécessitant des réparations à un centre de service autorisé Alpine ou à Alpine même et en assumer les frais de transport. Alpine a le choix entre réparer le produit ou le remplacer par un produit neuf ou révisé, le tout sans frais pour vous. Si les réparations sont couvertes par la garantie et si le produit a été envoyé à un centre de service Alpine ou à Alpine, le paiement des frais de réexpédition du produit incombe Alpine.

- ② Vous devez donner une description détaillée des problèmes qui sont à l'origine de votre demande de réparation.
- ③ Vous devez joindre la preuve de votre achat du produit.
- ④ Vous devez emballer soigneusement le produit pour éviter tout dommage durant son transport. Pour éviter la perte de l'envoi, il est conseillé de choisir un transporteur qui propose un service de suivi des envois.

● LIMITATION DES GARANTIES TACITES

LA DURÉE DE TOUTES LES GARANTIES TACITES, Y COMPRIS LA GARANTIE D'ADAPTATION À L'UTILISATION ET LA GARANTIE DE QUALITÉ LOYALE ET MARCHANDE, EST LIMITÉE À CELLE DE LA GARANTIE EXPRESSE DÉTERMINÉE CI-DESSUS. PERSONNE N'EST AUTORISÉ À ENGAGER AUTREMENT LA RESPONSABILITÉ D'ALPINE EN VERTU DE LA VENTE D'UN PRODUIT.

● EXCLUSIONS DE LA GARANTIE

ALPINE STIPULE EXPRESSÉMENT QU'ELLE N'EST PAS RESPONSABLE DES DOMMAGES-INTÉRÊTS ET DOMMAGES INDIRECTS PROVOQUÉS PAR LE PRODUIT. LES DOMMAGES-INTÉRÊTS SONT LES FRAIS DE TRANSPORT DU PRODUIT VERS UN CENTRE DE SERVICE ALPINE, LA PERTE DE TEMPS DE L'ACHETEUR ORIGINAL, LA PERTE D'UTILISATION DU PRODUIT, LES BILLETS D'AUTOBUS, LA LOCATION DE VOITURES ET TOUS LES AUTRES FRAIS LIÉS À LA GARDE DU PRODUIT. LES DOMMAGES INDIRECTS SONT LES FRAIS DE RÉPARATION OU DE REMPLACEMENT D'AUTRES BIENS ENDOMMAGÉS SUITE AU MAUVAIS FONCTIONNEMENT DU PRODUIT. LES RECOURS PRÉVUS PAR LES PRÉSENTES EXCLUS ET REMPLACENT TOUTE AUTRE FORME DE RECOURS.

● LIEN ENTRE LA GARANTIE ET LA LOI

La garantie vous donne des droits spécifiques, mais vous pouvez aussi jouir d'autres droits, qui varient d'un état ou d'une province à l'autre. En outre, certains états et certaines provinces interdisent de limiter la durée des garanties tacites ou d'exclure les dommages accessoires ou indirects. Dans ce cas, les limites et les exclusions de la garantie peuvent ne pas s'appliquer à vous.

● CLAUSE APPLICABLE AU CANADA SEULEMENT

Pour que la garantie soit valable, il faut qu'un centre d'installation autorisé ait installé le système audio pour l'auto dans votre véhicule et qu'il ait ensuite apposé son cachet sur la garantie.

● NUMÉROS D'APPEL DU SERVICE À LA CLIENTÈLE

Si vous avez besoin de nos services, veuillez appeler Alpine aux numéros ci-dessous pour le centre de service autorisé Alpine le plus proche.

AUDIO DE VOITURE NAVIGATION	1-800-ALPINE-1 (1-800-257-4631) 1-888-NAV-HELP (1-888-628-4357)
--	--

Où visitez notre site Web à l'adresse <http://www.alpine-usa.com>



LIMITED WARRANTY

ALPINE ELECTRONICS OF AMERICA, INC. ("Alpine"), is dedicated to quality craftsmanship and are pleased to offer this Warranty. We suggest that you read it thoroughly. Should you have any questions, please contact your Dealer or contact Alpine at one of the telephone numbers listed below.

● PRODUCTS COVERED:

This Warranty covers Car Audio Products and Related Accessories ("the product"). Products purchased in the Canada are covered only in the Canada. Products purchased in the U.S.A. are covered only in the U.S.A.

● LENGTH OF WARRANTY:

This Warranty is in effect for one year from the date of the first consumer purchase.

● WHO IS COVERED:

This Warranty only covers the original purchaser of the product, who must reside in the United States, Puerto Rico or Canada.

● WHAT IS COVERED:

This Warranty covers defects in materials or workmanship (parts and labor) in the product.

● WHAT IS NOT COVERED:

This Warranty does not cover the following:

- ① Damage occurring during shipment of the product to Alpine for repair (claims must be presented to the carrier).
- ② Damage caused by accident or abuse, including burned voice coils caused by over-driving the speaker (amplifier level is turned up and driven into distortion or clipping). Speaker mechanical failure (e.g. punctures, tears or rips). Cracked or damaged LCD panels. Dropped or damaged hard drives.
- ③ Damage caused by negligence, misuse, improper operation or failure to follow instructions contained in the Owner's manual.
- ④ Damage caused by act of God, including without limitation, earthquake, fire, flood, storms or other acts of nature. Any cost or expense related to the removal or reinstallation of the product.
- ⑤ Service performed by an unauthorized person, company or association.
- ⑥ Any product which has the serial number defaced, altered or removed.
- ⑦ Any product which has been adjusted, altered or modified without Alpine's consent.
- ⑧ Any product not distributed by Alpine within the United States, Puerto Rico or Canada.
- ⑨ Any product not purchased from an Authorized Alpine Dealer.

● HOW TO OBTAIN WARRANTY SERVICE:

- ① You are responsible for delivery of the product to an Authorized Alpine Service Center or Alpine for repair and for payment of any initial shipping charges. Alpine will, at its option, repair or replace the product with a new or reconditioned product without charge. If the repairs are covered by the warranty, and if the product was shipped to an Authorized Alpine Service Center or Alpine, Alpine will pay the return shipping charges.
- ② You should provide a detailed description of the problem(s) for which service is required.
- ③ You must supply proof of your purchase of the product.
- ④ You must package the product securely to avoid damage during shipment. To prevent lost packages it is recommended to use a carrier that provides a tracking service.

● HOW WE LIMIT IMPLIED WARRANTIES:

ANY IMPLIED WARRANTIES INCLUDING FITNESS FOR USE AND MERCHANTABILITY ARE LIMITED IN DURATION TO THE PERIOD OF THE EXPRESS WARRANTY SET FORTH ABOVE AND NO PERSON IS AUTHORIZED TO ASSUME FOR ALPINE ANY OTHER LIABILITY IN CONNECTION WITH THE SALE OF THE PRODUCT.

● HOW WE EXCLUDE CERTAIN DAMAGES:

ALPINE EXPRESSLY DISCLAIMS LIABILITY FOR INCIDENTAL AND CONSEQUENTIAL DAMAGES CAUSED BY THE PRODUCT. THE TERM "INCIDENTAL DAMAGES" REFERS TO EXPENSES OF TRANSPORTING THE PRODUCT TO THE ALPINE SERVICE CENTER, LOSS OF THE ORIGINAL PURCHASER'S TIME, LOSS OF THE USE OF THE PRODUCT, BUS FARES, CAR RENTALS OR OTHERS COSTS RELATING TO THE CARE AND CUSTODY OF THE PRODUCT. THE TERM "CONSEQUENTIAL DAMAGES" REFERS TO THE COST OF REPAIRING OR REPLACING OTHER PROPERTY WHICH IS DAMAGED WHEN THIS PRODUCT DOES NOT WORK PROPERLY. THE REMEDIES PROVIDED UNDER THIS WARRANTY ARE EXCLUSIVE AND IN LIEU OF ALL OTHERS.

● HOW STATE/PROVINCIAL LAW RELATES TO THE WARRANTY:

This Warranty gives you specific legal rights, and you may also have other rights which vary from state to state and province to province. In addition, some states/provinces do not allow limitations on how long an implied warranty lasts, and some do not allow the exclusion or limitation of incidental or consequential damages. Accordingly, limitations as to these matters contained herein may not apply to you.

● IN CANADA ONLY:

This Warranty is not valid unless your Alpine car audio product has been installed in your vehicle by an Authorized Installation Center, and this warranty stamped upon installation by the installation center.

● HOW TO CONTACT CUSTOMER SERVICE:

Should the product require service, please call the following number for your nearest Authorized Alpine Service Center.

CAR AUDIO NAVIGATION	1-800-ALPINE-1 (1-800-257-4631) 1-888-NAV-HELP (1-888-628-4357)
---------------------------------	--

Or visit our website at; <http://www.alpine-usa.com>

ALPINE ELECTRONICS OF AMERICA, INC., 1500 Atlantic Blvd, Auburn Hills, Michigan 48326, U.S.A.

Do not send products to this address.

Call the toll free telephone number or visit the website to locate a service center.



ALPINE ELECTRONICS MARKETING, INC.

1-7, Yukigaya-Otsukamachi, Ota-ku,
Tokyo 145-0067, JAPAN
Phone: 03-5499-4531

ALPINE ELECTRONICS OF AMERICA, INC.

1500 Atlantic Blvd,
Auburn Hills, Michigan 48326, U.S.A.
Phone 1-800-ALPINE-1 (1-800-257-4631)

ALPINE ELECTRONICS OF AUSTRALIA PTY. LIMITED

161-165 Princes Highway,
Hallam Victoria 3803, Australia
Phone 03-8787-1200

ALPINE ELECTRONICS GmbH

Ohmstraße 4
85716 Unterschleißheim, Germany
Phone: 089-32 42 640

ALPINE ELECTRONICS OF U.K., LTD.

Alpine House Fletchamstead Highway,
Coventry CV4 9TW, U.K.
www.alpine.co.uk

ALPINE ELECTRONICS FRANCE S.A.R.L.

184 allée des Erables
CS 52016 – Villepinte
95 945 Roissy CDG cedex
FRANCE

Phone : + 33(0)1 48 63 89 89

ALPINE ITALIA S.p.A.

Viale Cristoforo Colombo, 8
20090 Trezzano sul Naviglio MI, Italy
Phone +39 02 484781

ALPINE ELECTRONICS DE ESPAÑA, S.A.

Portal de Gamarra 36, Pabellón, 32
01013 Vitoria (Alava)-APDO 133, Spain
Phone 945-283588

Take a moment to protect your purchase by registering your product now at www.alpine-usa.com/registration. You will also be updated on product information, special promotions, Alpine news.

Prenez le temps de protéger votre achat en enregistrant votre produit sur www.alpine-usa.com/registration. Vous recevrez en outre des mises à jours sur des informations de produits, des offres promotionnelles et des nouvelles concernant Alpine.

Le recomendamos que proteja su adquisición registrando su producto lo antes posible en la dirección www.alpine-usa.com/registration. Asimismo, recibirá información sobre productos, promociones especiales y noticias de Alpine.