

MRDR224 - 24" REFRIGERATED DRAWERS

THE ESSENTIAL COLLECTION



DESIGN

Cylindrical drawer pulls on stainless steel model.

Panel-ready model accepts custom drawer panel.

Stainless steel drawers.

FEATURES

Built for both **indoor & outdoor use.**

Carbon filter for enhanced air quality and odor reduction.

Door alarm activates when the drawer is left open.

Effortless Entry Drawer: Minimizes the physical effort needed, enhancing ease of use for all family members.

Electronic touch control enables precise temperature selection from **34°F to 61°F.**

Evenly distributed forced-air refrigeration system delivers rapid cool down and temperature stability.

Four leveling legs adjustable up to 1 inch.

Sabbath Mode disables interior lights, alarms, and digital displays while maintaining consistent cooling performance.

Six-color multi-point LED lighting in adjustable white: bright white, warm white, cool white, and light blue, deep blue, and teal.

STORAGE

5.0 cu. ft. capacity stores up to **119 12-oz cans.**

Two 3/4-extension drawers.

CAPACITY

Volume	5.0 cu. ft.
Cans (12 oz)	119

DIMENSIONS

Product Depth	22 9/16" (57.3 cm)
Product Height (Min.)	33 5/8" (85.4 cm)
Product Width	23 1/2" (60 cm)
Product Weight	125 lbs
Shipping Depth	31" (78.7 cm)
Shipping Height	37" (94 cm)
Shipping Width	28" (71.1 cm)
Shipping Weight	145 lbs

CUSTOM PANEL DIMENSIONS

Panel Height	30 7/16" (77.3 cm)
Panel Thickness	5/8" (1.6 cm) or 3/4" (1.9 cm)
Panel Width	23 5/8" (60 cm)
Panel Weight (Max.)	40 lbs
Panel Type	Solid panel

SUSTAINABILITY

Refrigerant Type	R600a
GWP (Global Warming Potential)	3 (very low)

TECHNICAL DETAILS

Cord Length	6 ft.
Electrical Requirements	115V / 60 Hz / 15A

WARRANTY

2 year parts & labor warranty / 6 year sealed system parts warranty (see complete warranty for details).



MRDR224 - 24" REFRIGERATED DRAWERS

THE ESSENTIAL COLLECTION



INSTALLATION

No additional clearance is needed for ventilation.

Do not obstruct front grille air flow.

Panel ready model requires 3/4" or 5/8" custom panel and handle (not supplied by Marvel).

Add 1/2" to the width for panel ready models with 3/4" integrated panel.

PRODUCT DIMENSIONS

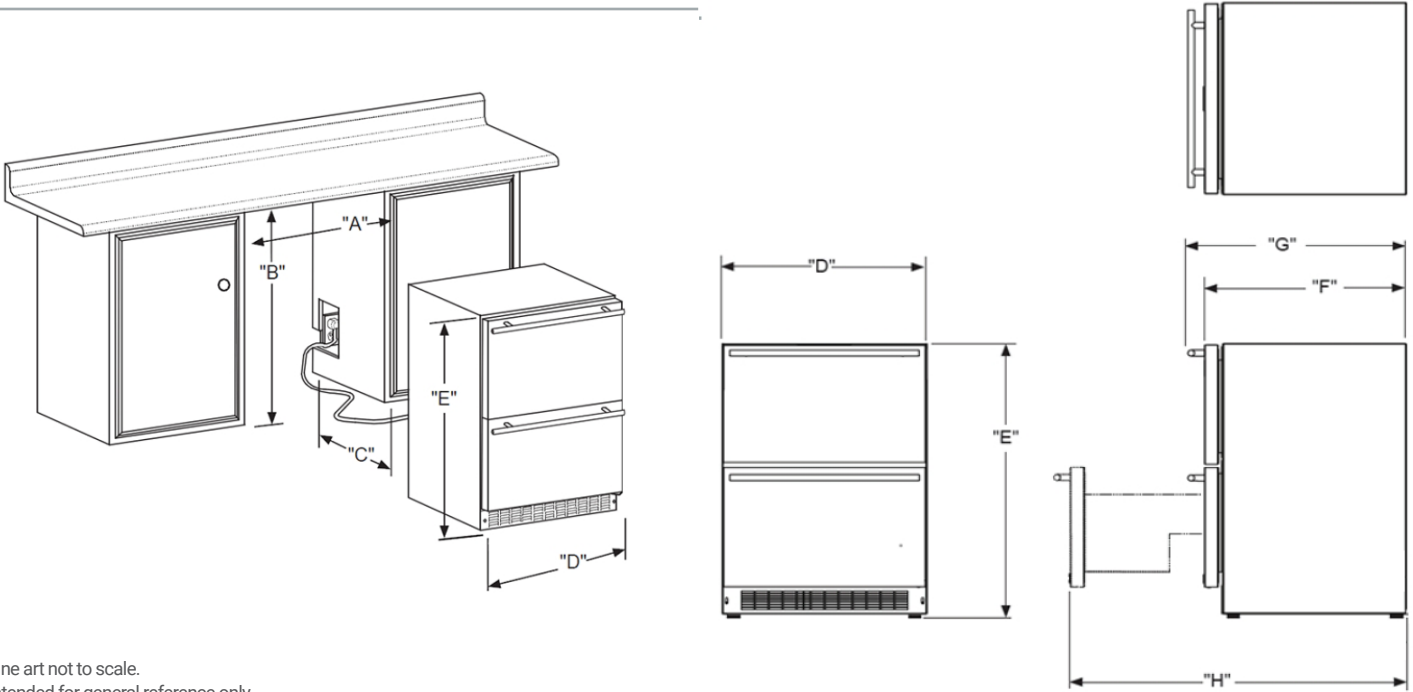

Line art not to scale.
Intended for general reference only.

ROUGH IN DIMENSIONS

"A"	"B"	"C"
24"	34 1/8" to 35 1/8"	24"
(61 cm)	(86.7 cm to 89.2 cm)	(61 cm)

CABINET DIMENSIONS

"D"	"E"	"F"	"G"	"H"
23 1/2"	33 5/8" to 34 5/8"	22 9/16"	24 1/4"	34 1/2"
(60 cm)	(85.4 cm to 88 cm)	(57.3 cm)	(61.6 cm)	(87.6 cm)

MODELS



MRDR224-SS71A
Stainless Steel Solid



MRDR224-IS71A
Panel Ready Solid