

O N K Y O

ICON SERIES

Amplificateur De Puissance M-80

Instruction Manual
POWER AMPLIFIER M-80

En

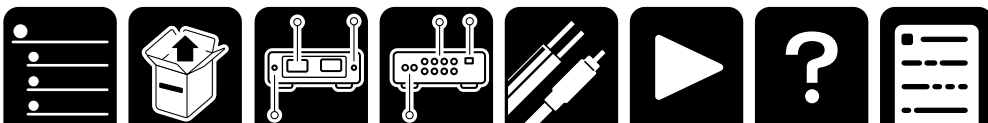

What's in the box	3
Part Names	4
Front Panel	4
Rear Panel	5
Connections	6
Connecting a Preamplifier	7
Connection using an unbalanced RCA cable	7
Connection using a balanced XLR cable	8
Connecting external control equipment	9
Connecting Your Speakers	10
Preparation	10
General connection	10
Connection using a banana plug or Y spade plug	11
Connecting the Power Cord	12
Playback	13
Basic Operations	14
Power ON/OFF	14
Backlight ON/OFF	14
Switching the Power Meter Range	15
Switching speakers	15
Setting Auto Standby (ASb)	16
Troubleshooting	17
General Specifications	18
North America and Japan models	18
Europe models	18
Asia and Oceania models	18
Common to all destinations	18
License and Trademark	19

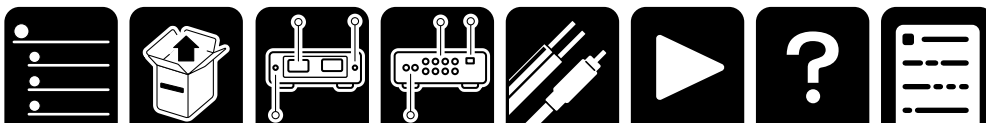

What's in the box

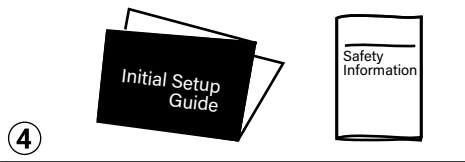
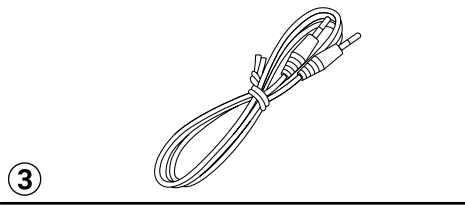
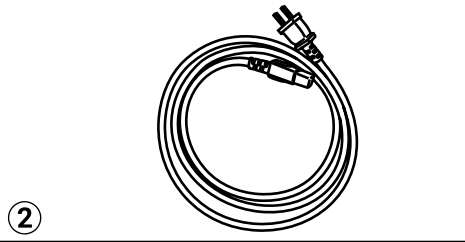
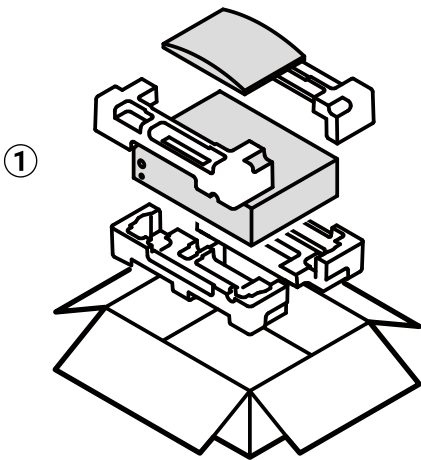

① **Main unit**

② **Power cord (1)**

Depending on the model, 2 or more Power Cords are supplied. Use the type of cord suited to your area.

③ **Mono mini-plug cable (1) (1.8 m/5.9 ft)**

This is used to connect the 12V trigger jacks. (→ [p9](#))

④ **Initial Setup Guide, Safety Information**

* This is an online user manual. This is not supplied with the product.

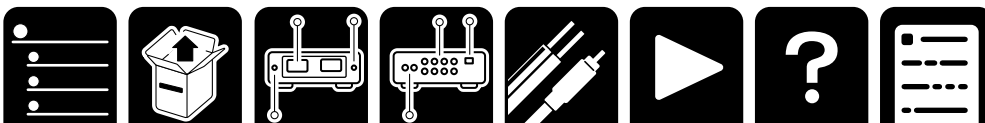

Part Names

Front Panel

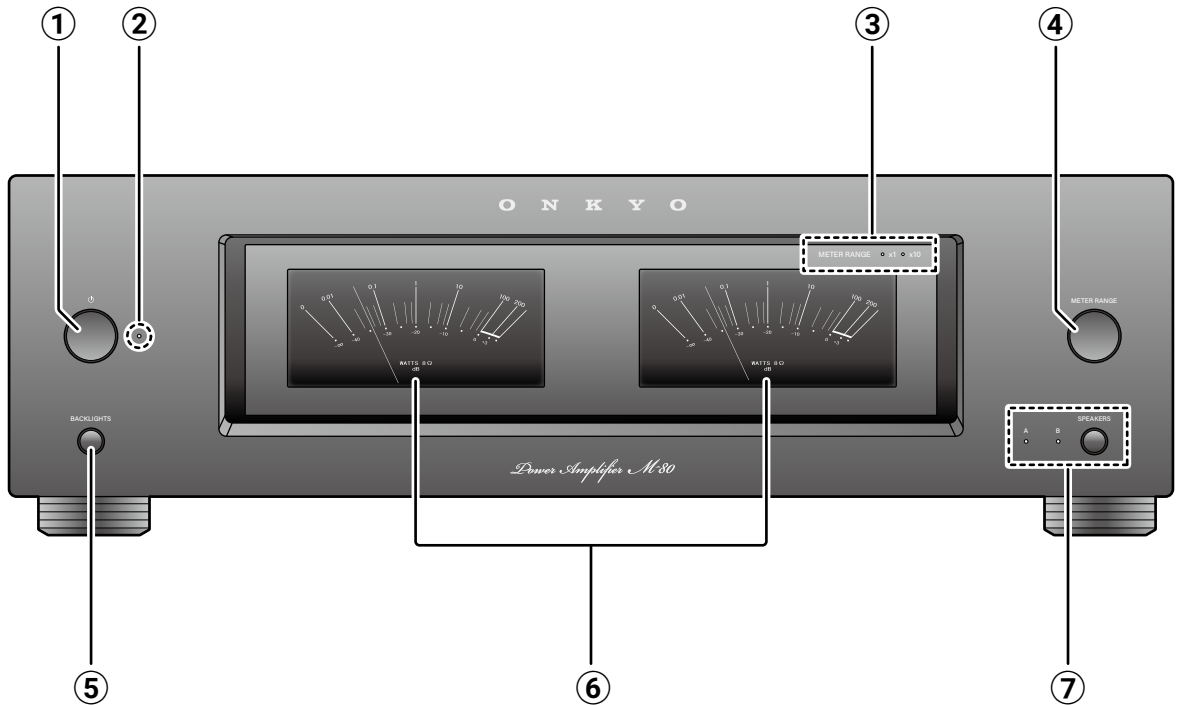

① **ON/STANDBY button** (→[p14](#))

This button is used to set the power amplifier to On or Standby.

② **Power indicator**

③ **METER RANGE LEDs** (→[p15](#))

x1 or x10 lights when the power meter range is x1 or x10.

④ **METER RANGE button** (→[p15](#))

This button is used to switch the power meter range.

⑤ **BACKLIGHTS button** (→[p14](#))

⑥ **Power meter**

The power meter shows the output power level.

⑦ **SPEAKERS button** (→[p15](#))

SPEAKER A/B indicator: Select the terminals to output audio from between SPEAKERS A/B.

- Depending on this setting, the impedance of a connectable speaker changes. For details, [see here](#) (→[p15](#)).

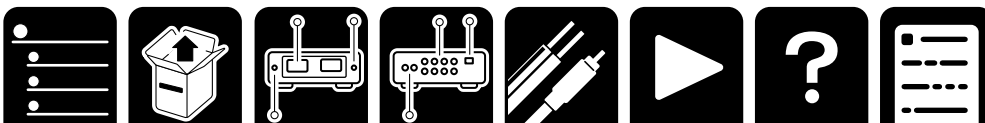

Rear Panel

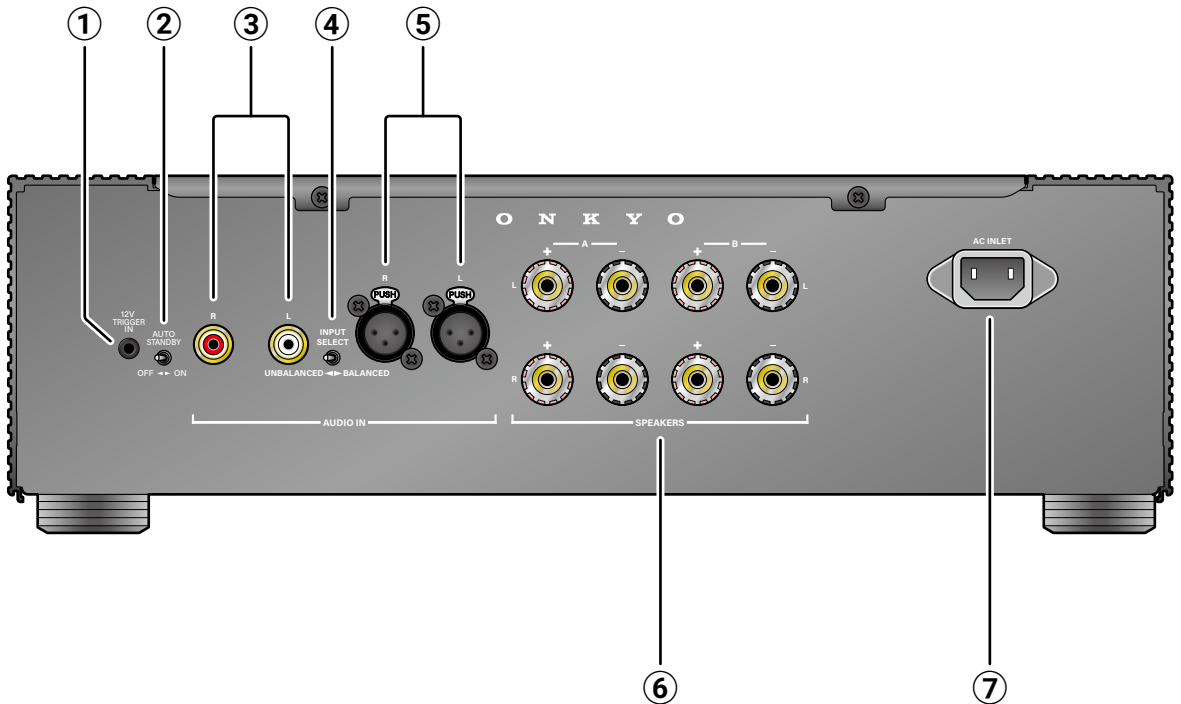

① 12V TRIGGER IN jack (→p9)

② AUTO STANDBY switch (→p16)

You can use the Auto Standby (ASb) function. If the power amplifier receives no signal for 20 minutes, it will automatically enter standby mode.

③ AUDIO IN UNBALANCED L/R jacks (→p7)

④ INPUT SELECT switch (→p7) (→p8)

This switch is used to switch the audio input terminal.

⑤ AUDIO IN BALANCED L/R jacks (→p8)

⑥ SPEAKERS terminals (→p10)

⑦ AC IN terminal (→p12)

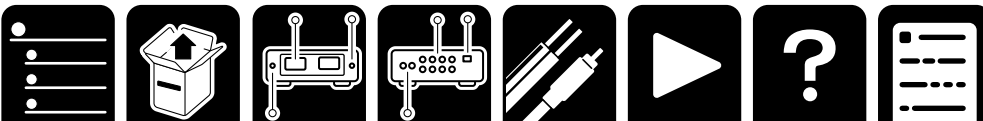

Connecting a Preamp	7
Connecting external control equipment	9
Connecting Your Speakers	10
Connecting the Power Cord	12

Note

- The illustration of the preamplifier uses P-80, the separately sold ONKYO preamplifier. When connecting another preamplifier, also check the instruction manual of the equipment to be connected.

Connections

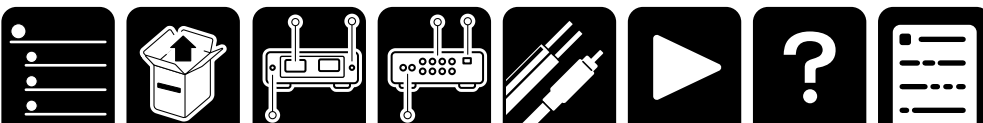

Connecting a Preamplifier

Connection using an unbalanced RCA cable

An unbalanced RCA cable (a) is a typical analog audio cable widely used for connection of audio equipment.

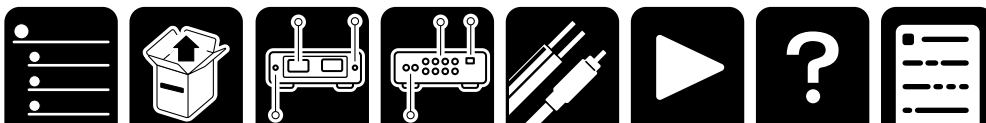
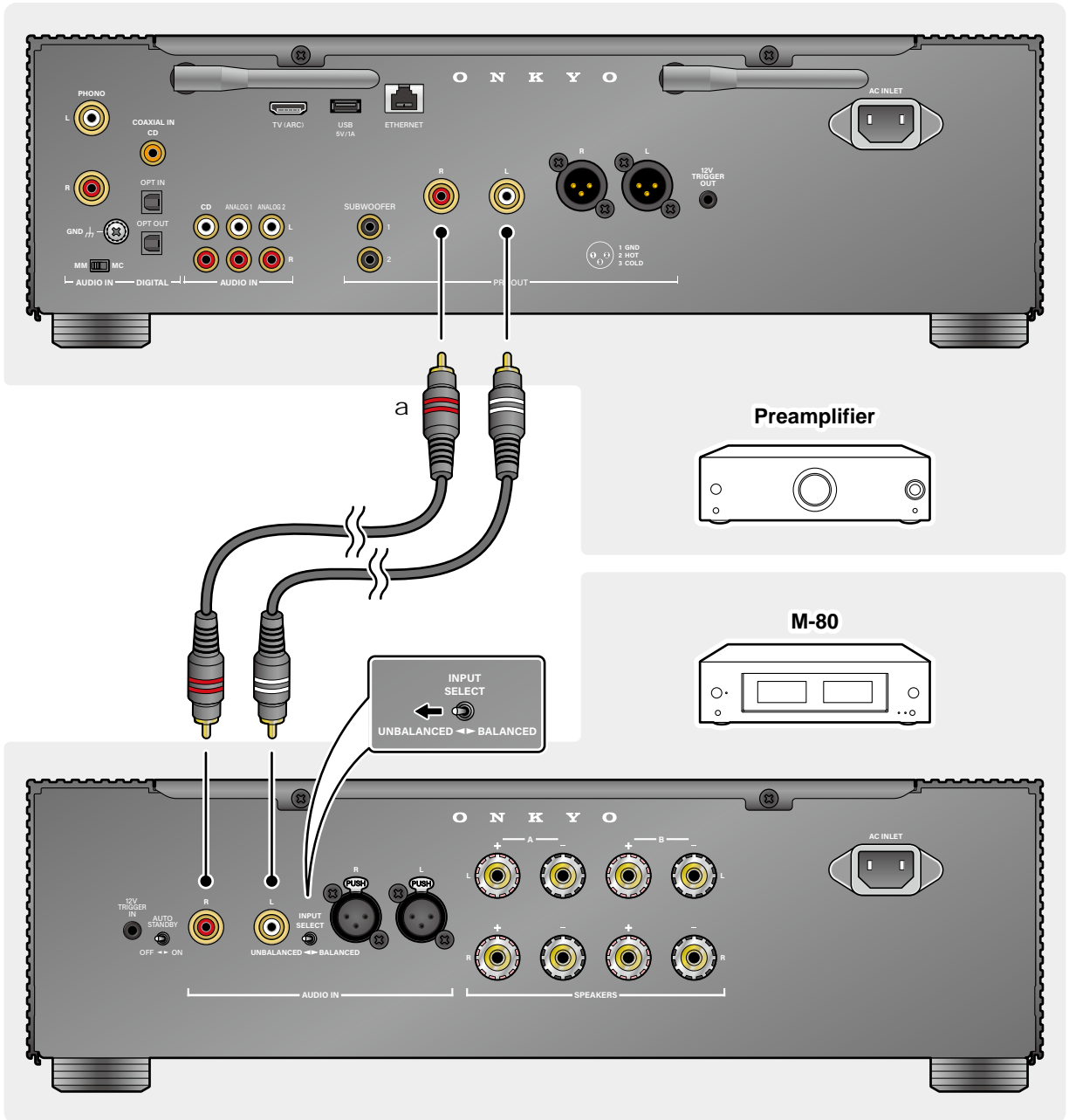

Connection using a balanced XLR cable

A balanced XLR cable (a) attenuates audio signals less than an unbalanced RCA cable, minimizing noise. This cable is suited when a long cable is required to connect to equipment remotely located.

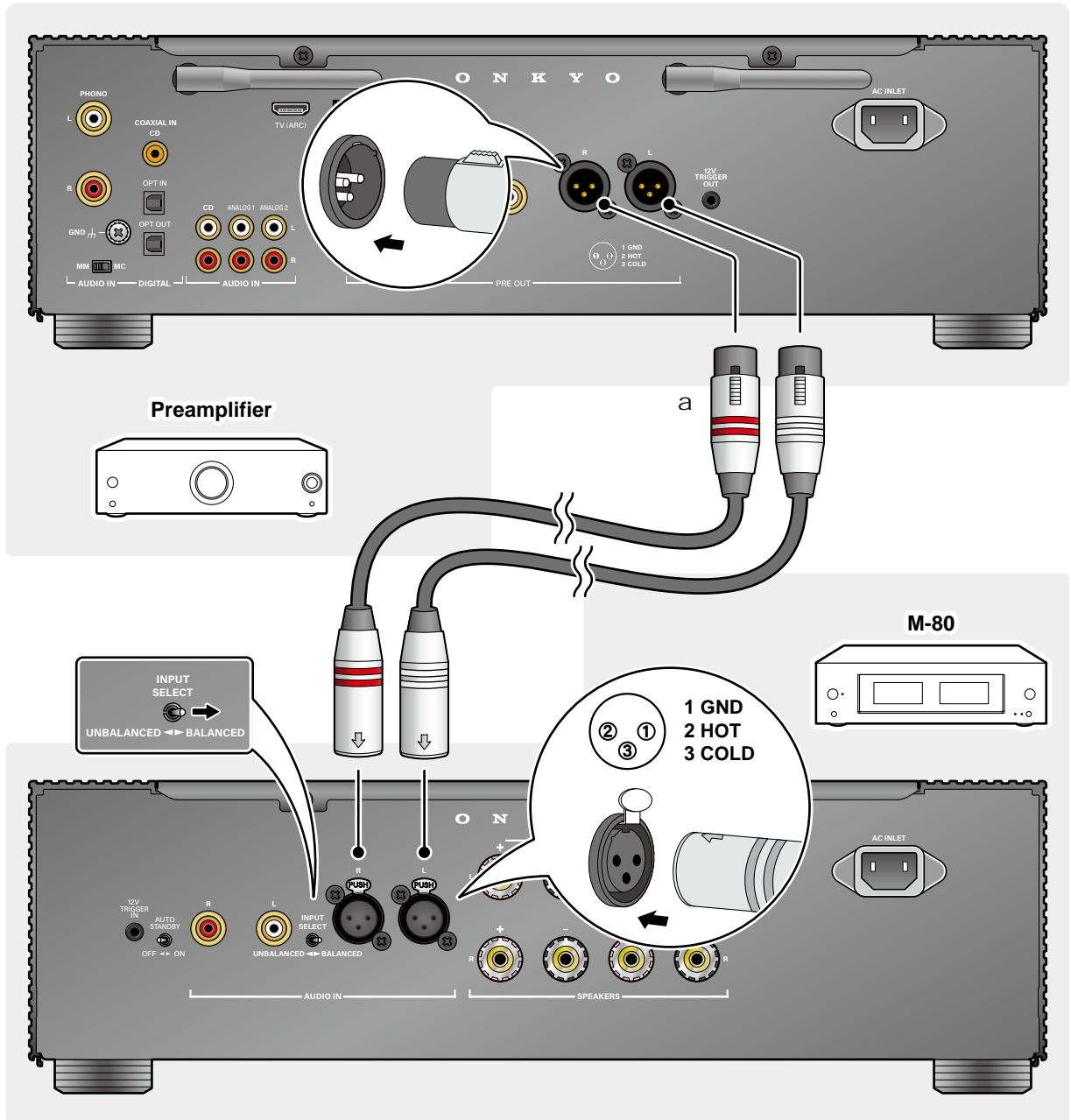

• To remove the XLR cable from this unit, press and hold the connector button (b), and pull the cable.

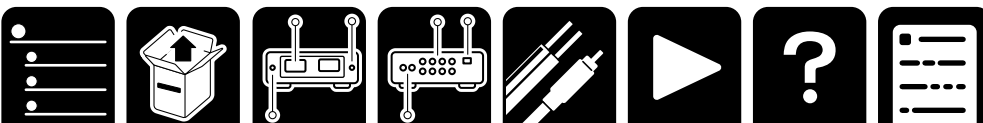
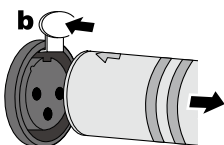

Connecting external control equipment

When connected to a preamplifier, etc. with 12V TRIGGER OUT terminal mounted, this unit can be turned on or enter the standby state by interlocking the power-on operation of the equipment.

- Use the supplied monaural mini-plug cable (a) for connection.
- When using a commercially available cable, use a monaural mini-plug cable ($\phi 3.5$ mm) without resistance. Do not use a stereo mini-plug cable.

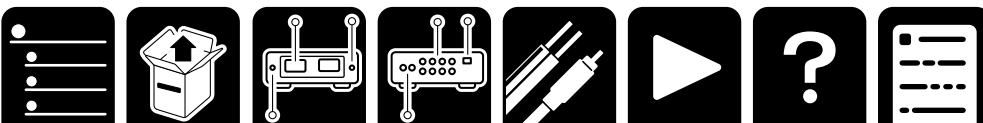
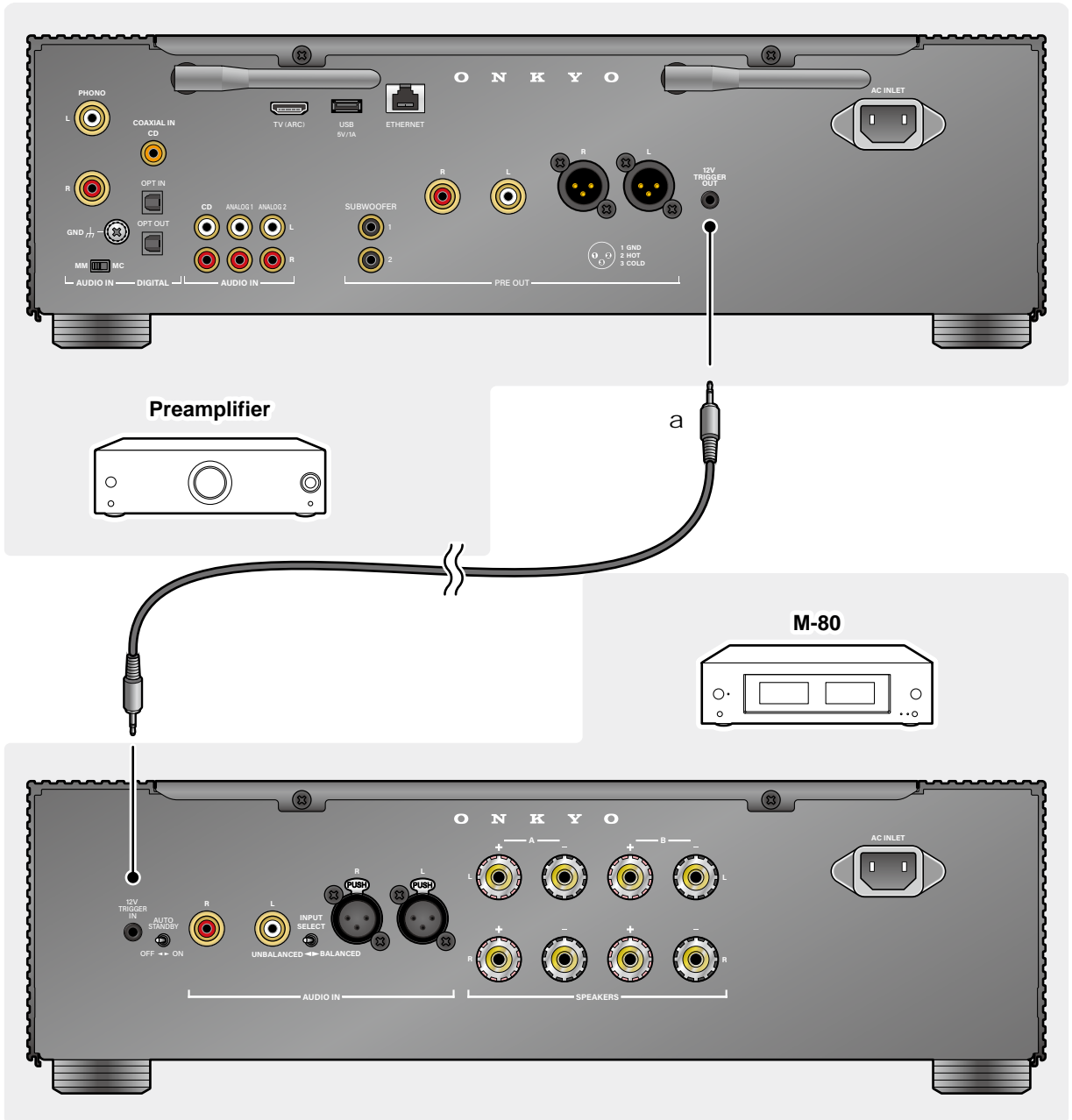

Connecting Your Speakers

Preparation

- When using only SPEAKER A or SPEAKER B, use a speaker with an impedance of 4 Ω to 16 Ω .
When using SPEAKER A and SPEAKER B at the same time, use speakers with an impedance of 8 Ω to 16 Ω .
- Firmly twist the core wire of the speaker cable, and insert it to the speaker terminal of this unit.

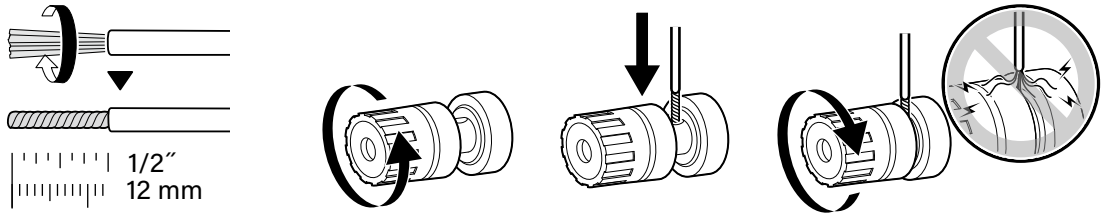

General connection

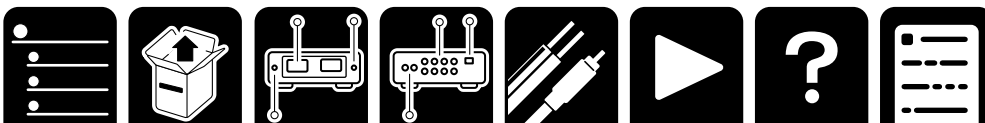
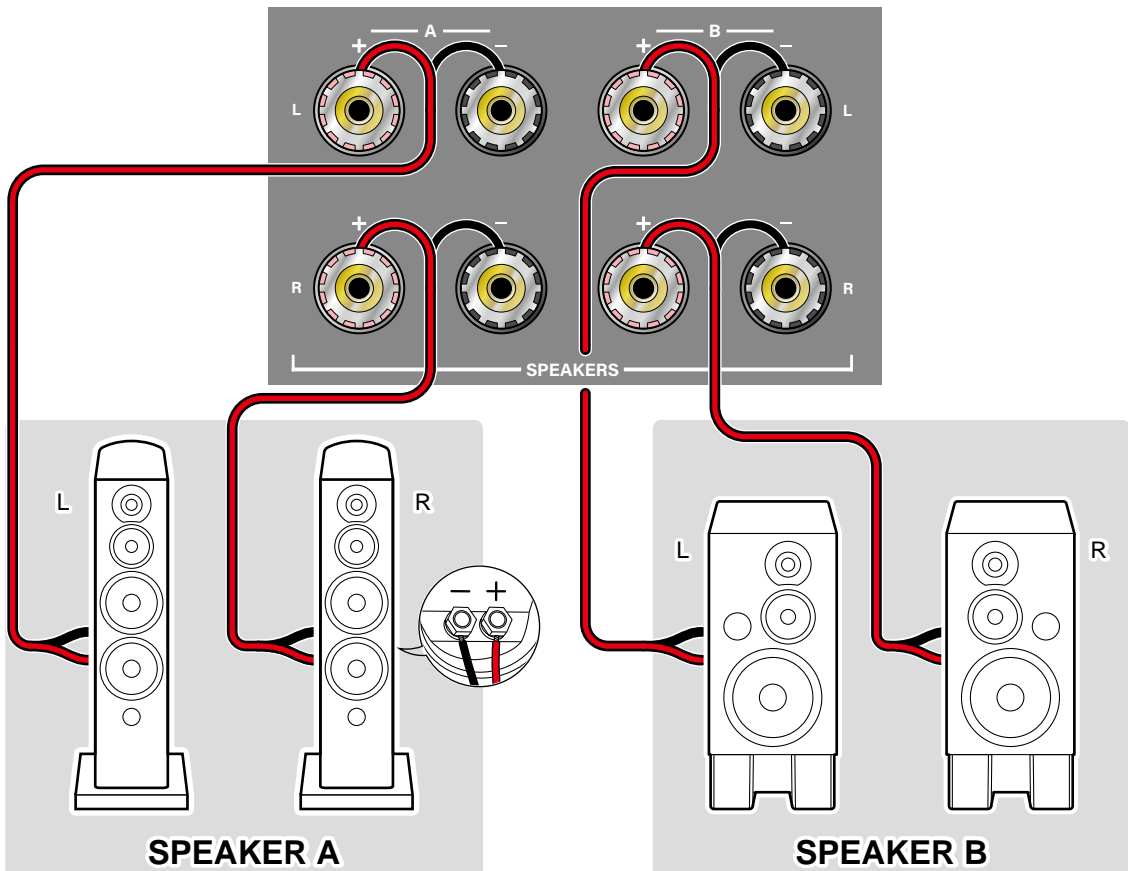

Connection using a banana plug or Y spade plug

The North America model and Japan model also support connection using a banana plug (a) and Y spade plug (b) in addition to the general connection method.

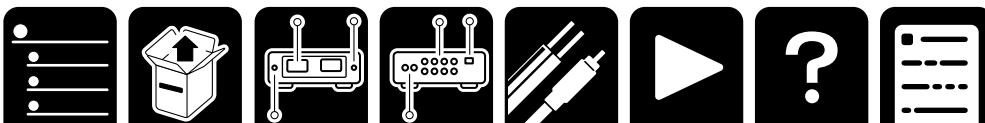
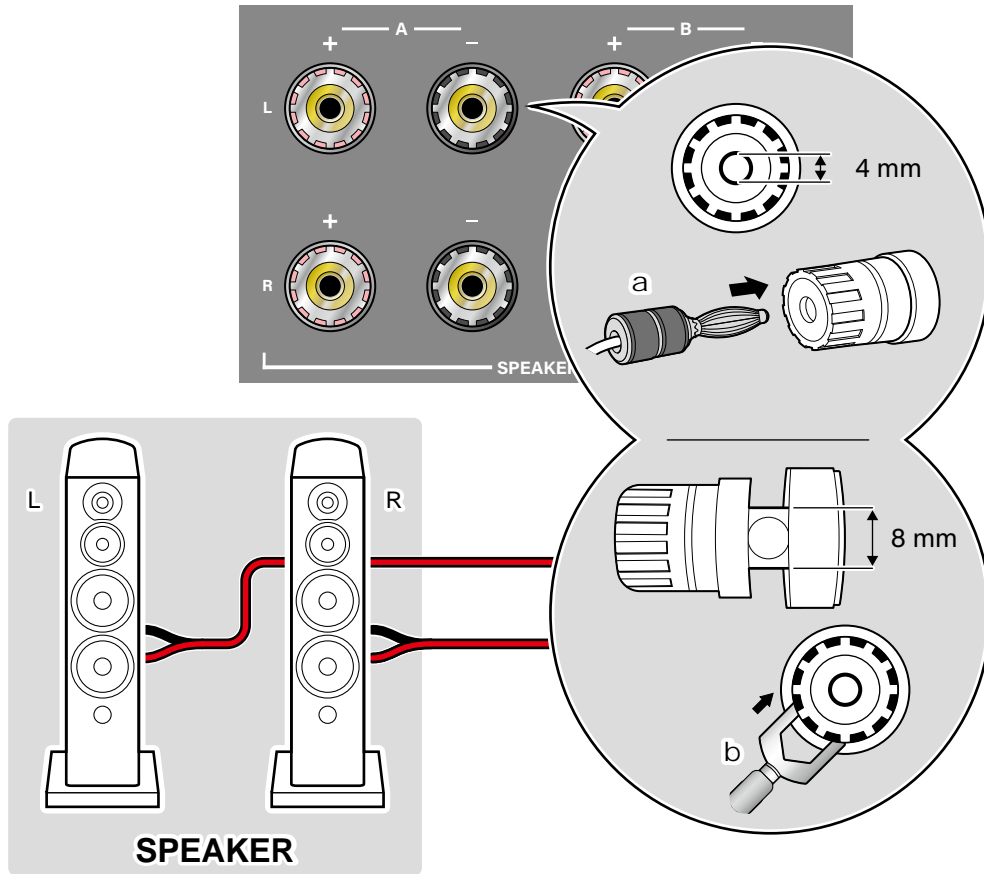

Connecting the Power Cord

Connect the power cord after all the connections are completed.

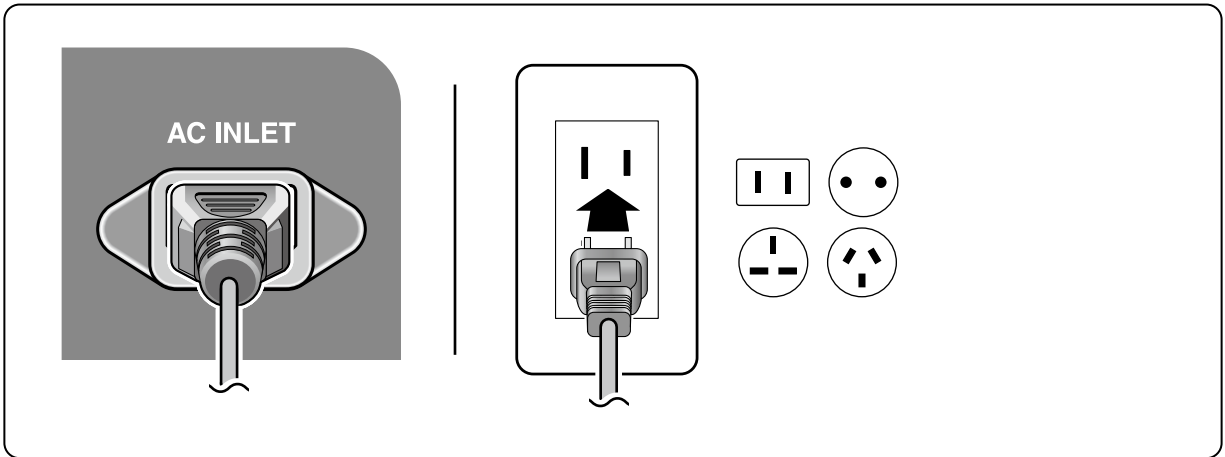

Note

Japan model: Adapt the power source polarity for enhancement of the sound quality. Align the N-printed side of the power plug supplied with this unit with the longer groove of the outlet, and insert the power plug. If both grooves of the outlet are the same in length, either side can be connected.

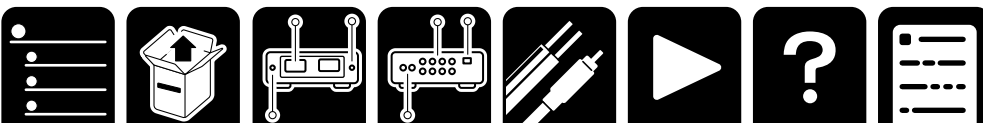
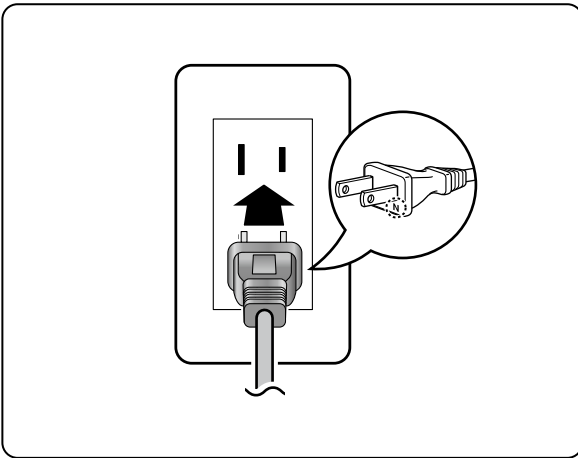

Basic Operations

Basic Operations	14
Power ON/OFF	14
Backlight ON/OFF	14
Switching the Power Meter Range	15
Switching speakers	15
Setting Auto Standby (ASb)	16

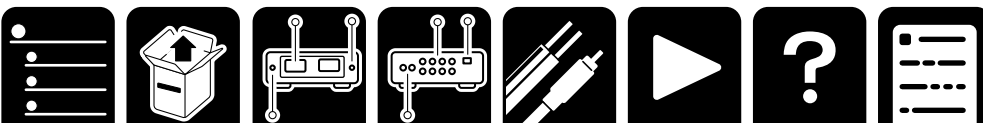

Basic Operations

Power ON/OFF

1. Press the ON/STANDBY $\text{\textcircled{P}}$ button on the front panel.

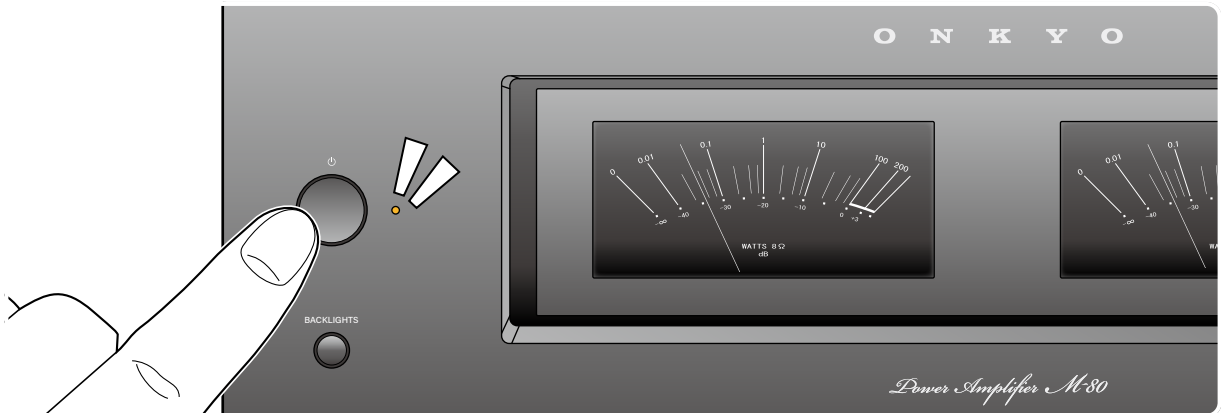

- Using the supplied monaural mini-plug cable allows for interlocking of an external device with power ON/standby. (→[p9](#))

Backlight ON/OFF

1. Press the BACKLIGHTS button on the front panel.

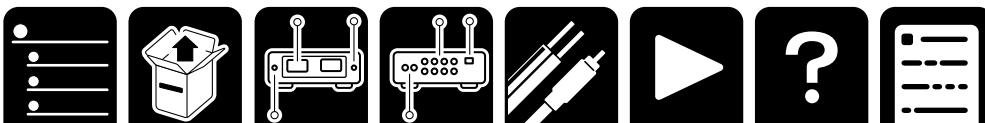

Switching the Power Meter Range

1. Press **METER RANGE** repeatedly to switch **METER RANGE** in the following order:
 ×1 (default), ×10, **Off**

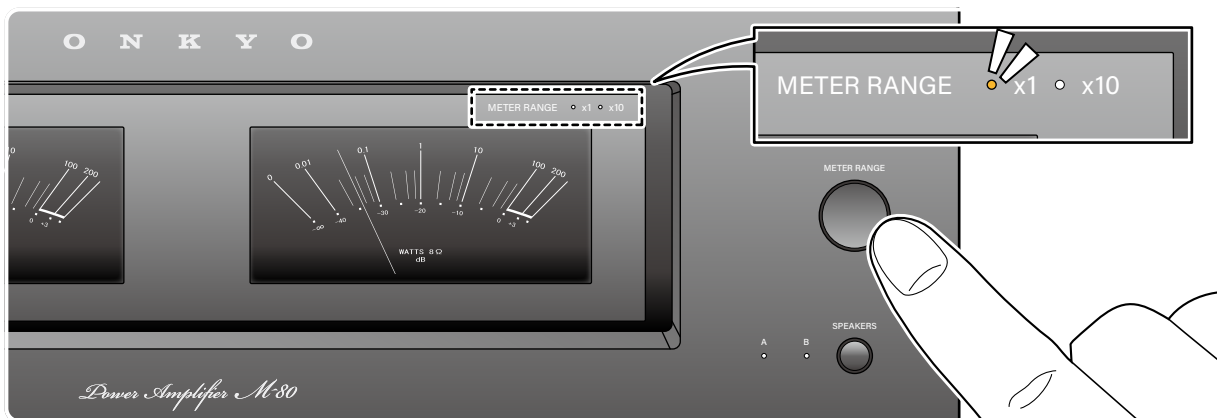

Note

The number of watts indicated on the meters corresponds to the actual output level when driving speakers rated at 8 ohms. When driving speakers rated at 4 ohms, the output is actually twice that shown on the power meters.

Switching speakers

When you have connected two sets of speakers to this unit, you can select which set to output the sound.

1. Press the **SPEAKERS** button on the front panel.
 The selection changes in the order **SPEAKER A**, **SPEAKER B**, **SPEAKER A+B** with each press.

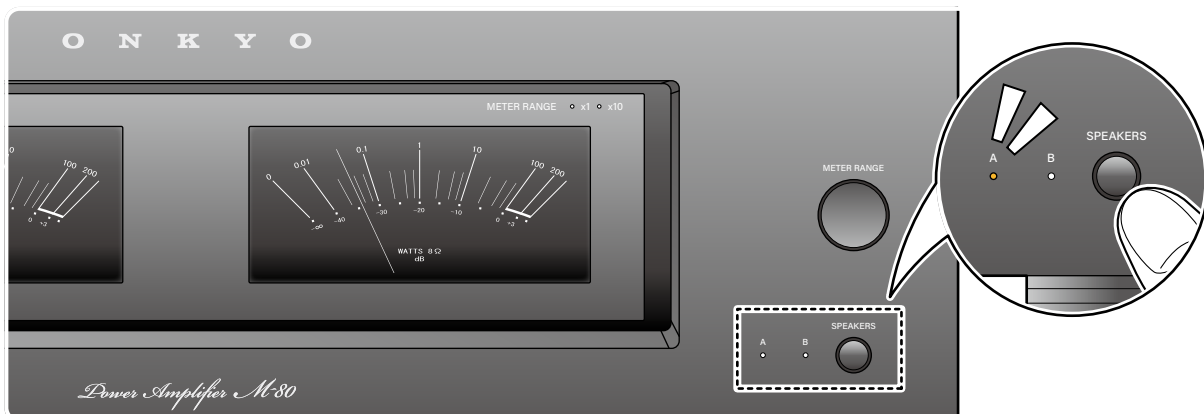

Note

When using only **SPEAKER A** or **SPEAKER B**, use a speaker with an impedance of 4 Ω to 16 Ω.

When using **SPEAKER A** and **SPEAKER B** at the same time, use speakers with an impedance of 8 Ω to 16 Ω.

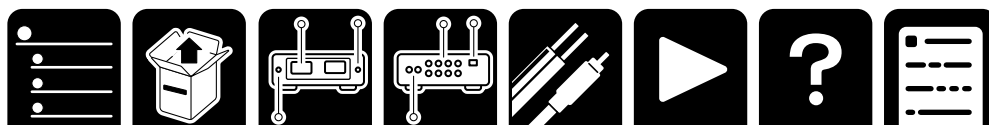
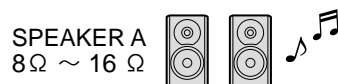
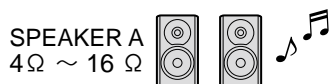

Setting Auto Standby (ASb)

When AUTO STANDBY is turned ON side, the power amplifier will automatically enter Standby mode if the power amplifier receives no signal for 20 minutes.

- When ASb (Auto Standby) is set to ON, the power indicator and power meter blink for 30 seconds immediately before the unit automatically enters the standby state.

1. Set ON/OFF by switching the AUTO STANDBY switch.

ON: ASb enabled.

OFF: ASb disabled.

- When set to off, power consumption increases as the power continues to turn on.

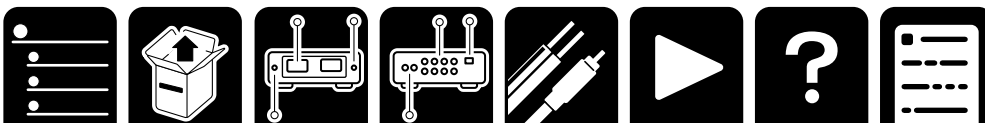
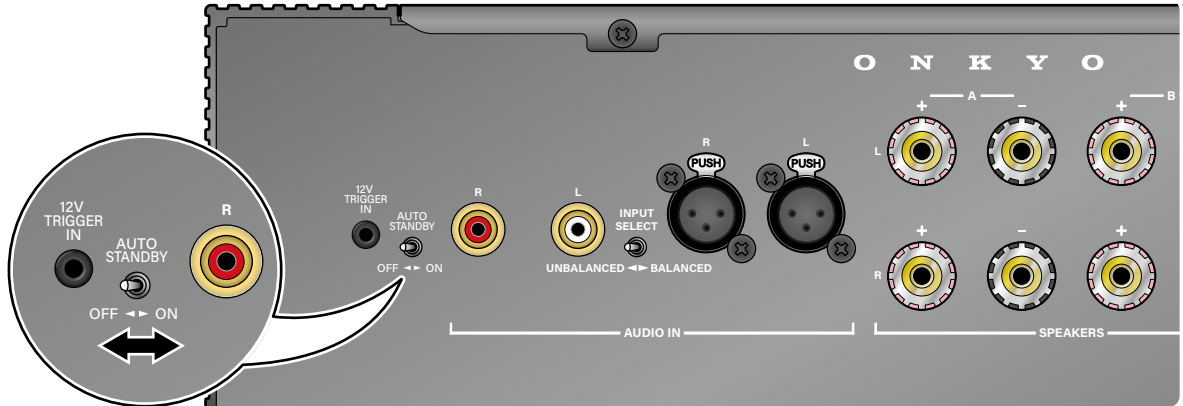

Troubleshooting

❑ When the unit is operating erratically

The problem may be solved by resetting the unit to restore all settings to the default states at the time of purchase.

Reset procedure

1. Turn on the power of the unit, and wait for approx. 10 seconds.
2. While pressing and holding the SPEAKERS button, press the ON/STANDBY button two times.
 - All indicators blink during reset.
3. When reset is complete, the unit enters the standby state.

❑ Troubleshooting: The power does not turn on.

If the problem persists even after the AC cord is reconnected, the unit failure may have occurred.

❑ Troubleshooting: No sound is delivered from the right or left speaker.

A contact failure or disconnection of the cable may have occurred. Reconnect the cable or use another cable and check the condition.

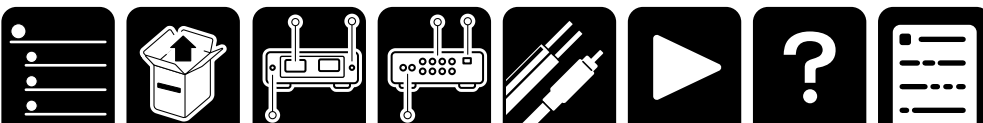

General Specifications

North America and Japan models

■ Amplifier Section

Rated Output Power

(North America models)

With 8 ohm loads, both channels driven, from 20 Hz-20 kHz; rated 130 watts per channel minimum RMS power, with no more than 0.08% total harmonic distortion from 250 milliwatts to rated output. (FTC)

(Japan models)

2 ch x 130 W at 8ohms, 20-20,000Hz, 2ch driven of 0.08% THD (JEITA)

THD+N (Total Harmonic Distortion + Noise)

• 0.08% (20 Hz - 20,000 Hz, Rated output power)

■ General

- Power Supply
AC 120 V, 60 Hz (North America model)
AC 100V, 50/60 Hz (Japan model)
- Power Consumption
445 W (North America model)
385 W (Japan model)
- Standby mode
0.2 W (North America model)
0.2 W (Japan model)
- Dimensions (W × H × D)
435 mm × 135 mm × 345 mm
17-1/8" × 5-5/16" × 13-9/16"
- Weight
11.4 kg (25.1 lbs.)

Europe models

■ Amplifier Section

Rated Output Power

2 ch × 140 W at 4 ohms, 1 kHz, 2 ch driven of 1% THD(IEC)

THD+N (Total Harmonic Distortion + Noise)

• 0.08% (20 Hz - 20,000 Hz, Rated output power)

■ General

- Power Supply
AC 220-240 V, 50/60 Hz
- Power Consumption
425 W
- Standby mode
0.3 W
- Dimensions (W × H × D)
435 mm × 135 mm × 345 mm
17-1/8" × 5-5/16" × 13-9/16"
- Weight
11.4 kg (25.1 lbs.)

Asia and Oceania models

■ Amplifier Section

Rated Output Power

2 ch × 140 W at 4 ohms, 1 kHz, 2 ch driven of 1% THD(IEC)

THD+N (Total Harmonic Distortion + Noise)

• 0.08% (20 Hz - 20,000 Hz, Rated output power)

■ General

- Power Supply
AC 220-240 V, 50/60 Hz
- Power Consumption
425 W
- Standby mode
0.3 W
- Dimensions (W × H × D)
435 mm × 135 mm × 345 mm
17-1/8" × 5-5/16" × 13-9/16"
- Weight
11.4 kg (25.1 lbs.)

Common to all destinations

Input Sensitivity and Impedance

- 1000 mV/52 kΩ (LINE(RCA))
- 1000 mV/20 kΩ (LINE(XLR))

Frequency Response

- 10 Hz - 100 kHz/+1 dB, -3 dB

Signal to Noise Ratio

- 106 dB (IHF-A, LINE IN, SP OUT)

Supported impedance of Speakers

- 4 Ω - 16 Ω (Speakers A or B)
- 8 Ω - 16 Ω (Speakers A + B)

Input terminals

- Analog
• 2 (RCA IN×1, XLR IN×1)

Other terminals

- Speaker terminal ×4
- 12V Trigger In jack ×1

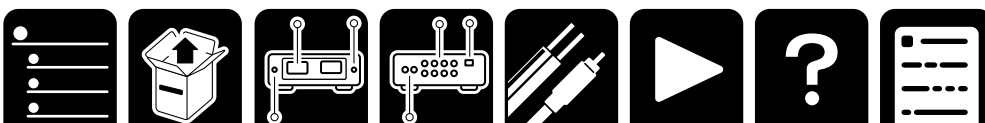

O N K Y O

SN 29404226_EN

© Copyright 2025 Premium Audio Company Technology Center K.K. All rights reserved. ©Copyright 2025 Premium Audio Company Technology Center K.K. Tous droits de reproduction et de traduction réservés.

O2508-0