

THANK YOU
for purchasing the Ninja® DoubleStack™ XL 2-Basket Air Fryer



REGISTER YOUR PURCHASE

- registeryourninja.com
- Scan QR code using mobile device

RECORD THIS INFORMATION

Model Number: _____
Serial Number: _____
Date of Purchase: _____
(Keep receipt)
Store of Purchase: _____

TECHNICAL SPECIFICATIONS

Voltage: 120V- 60Hz
Watts: 1690W

TIP: You can find the model and serial numbers on the QR code label on the back of the unit by the power cord.

SharkNinja Operating LLC
US: Needham, MA 02494
1-877-646-5288
ninjakitchen.com

Illustrations may differ from actual product. We are constantly striving to improve our products, therefore the specifications contained herein are subject to change without notice.

NINJA is a registered trademark of SharkNinja Operating LLC.

DOUBLESTACK, MATCH COOK, and SMART FINISH are trademarks of SharkNinja Operating LLC.

© 2024 SharkNinja Operating LLC

SL401_IB_MP_Mv9



@ninjakitchen

NINJA®

DOUBLESTACK™ XL 2-BASKET AIR FRYER SL401 | Owner's Guide



IMPORTANT SAFETY INSTRUCTIONS

INDOOR HOUSEHOLD USE ONLY. READ ALL INSTRUCTIONS BEFORE USE

	Read and review instructions to understand operation and use of product.
	Indicates the presence of a hazard that can cause personal injury, death or substantial property damage if the warning included with this symbol is ignored.
	Avoid contact with hot surface. Always use hand protection to avoid burns.
	For indoor and household use only

WARNING

Failure to follow these instructions could result in electric shock, fire or burn hazard which could cause property damage, personal injury, or death. When using electrical appliances, basic safety precautions should always be followed, including the following:

- 1 This appliance can be used by persons with reduced physical, sensory or mental capabilities or lack of experience and knowledge if they have been given supervision or instruction concerning use of the appliance in a safe way and understand the hazards involved.
- 2 Keep the appliance and its cord out of reach of children. **DO NOT** allow the appliance to be used by children. Close supervision is necessary when used near children.
- 3 Children should not play with the appliance.
- 4 **DO NOT** place or store anything on top of product when in use.
- 5 To prevent fire, **DO NOT** place appliance on or near a gas or electric hob, or in a heated oven.
- 6 **NEVER** use electrical socket below counter.
- 7 **NEVER** connect this appliance to an external timer switch or separate remote-control system.
- 8 **DO NOT** use an extension cord. A short power-supply cord is used to reduce the risk of children less than 8 years grabbing the cord or becoming entangled and to reduce the risk of people tripping over a longer cord.
- 9 To protect against electrical shock **DO NOT** immerse cord, plugs, or main unit housing in water or other liquid. Cook only in the basket provided.
- 10 Regularly inspect the appliance and power cord. **DO NOT** use the appliance if there is damage to the power cord or plug. If the appliance malfunctions or has been damaged in any way, immediately stop use and call Customer Service.
- 11 ALWAYS ensure the appliance is properly assembled before use.
- 12 **DO NOT** cover the air intake vent or air outlet while unit is operating. Doing so will prevent even cooking and may damage the unit or cause it to overheat.
- 13 Before placing removable basket into the main unit, ensure basket and unit are clean and dry by wiping with a soft cloth.
- 14 This appliance is for household use only. **DO NOT** use this appliance for anything other than its intended use. **DO NOT** use in moving vehicles or boats. **DO NOT** use outdoors. Misuse may cause injury.
- 15 Intended for worktop use only. Ensure the surface is level, clean and dry. **DO NOT** move the appliance when in use.
- 16 **DO NOT** place the appliance near the edge of a worktop during operation.
- 17 **DO NOT** use accessory attachments not recommended or sold by SharkNinja. Do not place accessories in a microwave, toaster oven, convection oven, or conventional oven or on a ceramic cooktop, electric coil, gas burner range or outdoor grill. The use of accessory attachments not recommended by SharkNinja may cause fire, electric shock or injuries.

IMPORTANT SAFETY INSTRUCTIONS

INDOOR HOUSEHOLD USE ONLY. READ ALL INSTRUCTIONS BEFORE USE

⚠ WARNING

Failure to follow these instructions could result in electric shock, fire or burn hazard which could cause property damage, personal injury, or death. When using electrical appliances, basic safety precautions should always be followed, including the following:

- 18 **ALWAYS** ensure basket is properly closed before operating.
- 19 **DO NOT** use the appliance without the removable basket installed.
- 20 **DO NOT** use this appliance for deep-frying.
- 21 Prevent food contact with heating elements. **DO NOT** overfill when cooking. Overfilling may cause personal injury or property damage or affect the safe use of the appliance.
- 22 Socket voltages can vary, affecting the performance of your product. To prevent possible illness, use a thermometer to check that your food is cooked to the temperatures recommended.
- 23 Should the unit emit black smoke, unplug immediately. Wait for smoking to stop before removing any cooking accessories.
- 24 **DO NOT** touch hot surfaces. Appliance surfaces are hot during and after operation. To prevent burns or personal injury, **ALWAYS** use protective hot pads or insulated oven mitts and use available handles.
- 25 Extreme caution must be used when the appliance contains hot food. Improper use may result in personal injury.
- 26 Spilled food can cause serious burns. Keep appliance and cord away from children. **DO NOT** let cord hang over edges of tables or counters or touch hot surfaces.
- 27 The basket and crisper plate become extremely hot during the cooking process. Avoid physical contact while removing the basket or plate from the appliance. **ALWAYS** place basket or plate on a heat-resistant surface after removing. **DO NOT** touch accessories during or immediately after cooking.
- 28 Cleaning and user maintenance should not be carried out by children.
- 29 To disconnect, turn off any control to OFF, then unplug from socket when not in use and before cleaning. Allow to cool before cleaning, disassembly, putting in or taking off parts and storage.
- 30 **DO NOT** clean with metal scouring pads. Pieces can break off the pad and touch electrical parts, creating the risk of electric shock.
- 31 Please refer to the Cleaning & Maintenance section for regular maintenance of the appliance.
- 32 **DO NOT** place any of the following materials in the unit: paper, cardboard, plastic, roasting bags and the like. They may cause fire.
- 33 Extreme caution should be exercised when using containers constructed of any materials other than metal or glass.
- 34 This appliance has a polarized plug (one blade is wider than the other). To reduce the risk of electric shock, this plug is intended to fit into a polarized outlet only one way. If the plug does not fit fully into the outlet, reverse the plug. If it still does not fit, contact a qualified electrician. Do not attempt to modify the plug in any way.

SAVE THESE INSTRUCTIONS

PARTS

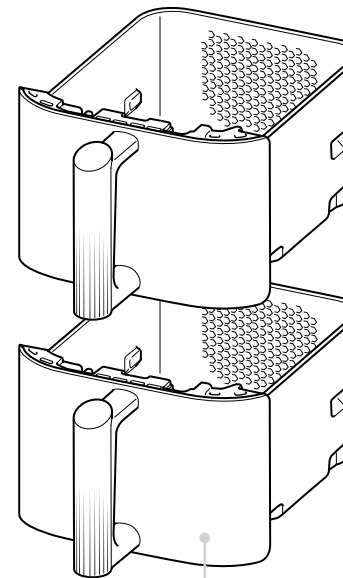
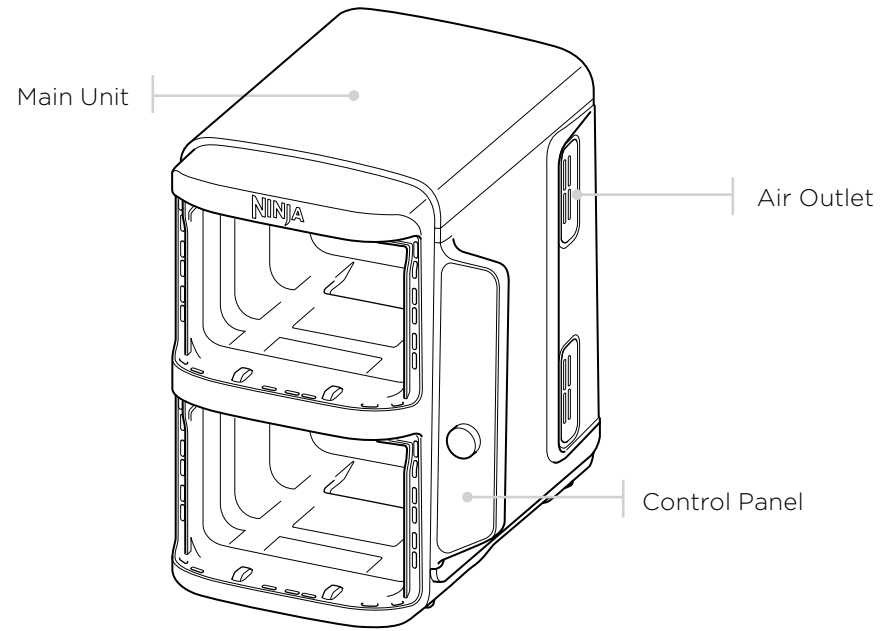

Nonstick Baskets
(one for each zone)

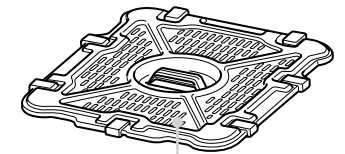

Nonstick
Crisper Plates (x 2)
(one for each basket)

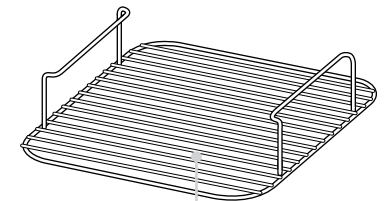

Stacked Meal
Racks (x 2)

GETTING TO KNOW YOUR AIR FRYER

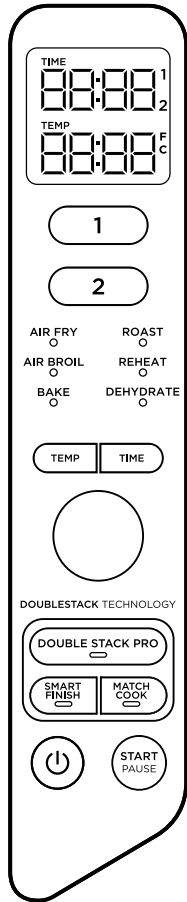

When setting time, the digital display shows HH:MM.

FUNCTION BUTTONS

AIR FRY: Use this function to give your food crispiness and crunch with little to no oil

AIR BROIL: Add the crispy finishing touch to meals, or melt toppings to create the perfect finish.

BAKE: Create decadent baked treats and desserts.

ROAST: Use the unit as an oven for tender meats and more.

REHEAT: Revive leftovers by gently warming them, leaving you with crispy results.

DEHYDRATE: Dehydrate meats, fruits and vegetables for healthy snacks.

Power button: The  button turns the unit on and also shuts it off and stops all cooking functions.

OPERATING BUTTONS

① Control the output for the basket on the top (Zone 1).

② Control the output for the basket on the bottom (Zone 2).

TEMP button: Press the TEMP button, then turn the dial to adjust the cook temperature before or during cooking.

TIME button: Press the TIME button, then turn the dial to adjust the cook time in any function before or during cooking.

DOUBLE STACK PRO button:

Use this function with the Stacked Meal Racks and the chart and recipes in your Quick Start Guide to mix and match 4 different foods at once.

SMART FINISH button:

Automatically syncs the cook times to ensure both Zones finish at the same time, even if they have different cook times.

MATCH COOK button:

Automatically matches Zone 2 settings to those of Zone 1 to cook a larger amount of the same food or cook different foods using the same function, temperature, and time.

START/PAUSE button: Rotate the dial from side to side to select desired function. Start cooking by pressing the START/PAUSE button.

MODES

HOLD Mode: HOLD will appear on the unit while in SMART FINISH mode. One Zone will be cooking, while the other Zone will be holding until the times sync together.

STANDBY Mode: After 10 minutes with no interaction with the control panel, the unit will enter standby mode.

BEFORE FIRST USE

- 1 Remove and discard any packaging material, promotional labels and tape from the unit.
- 2 Remove all accessories from the package and read this manual carefully. Please pay particular attention to operational instructions, warnings and important safeguards to avoid any injury or property damage.
- 3 Wash the baskets, crisper plates, and Stacked Meal Racks in hot, soapy water, then rinse and dry thoroughly. The baskets, crisper plates, and racks are the **ONLY** dishwasher-safe parts. However, to extend their life, we recommend hand-washing them. **NEVER** clean the main unit in the dishwasher.

COOKING IN YOUR AIR FRYER

REFERENCE QUICK START GUIDE FOR RECIPES AND COOKING CHARTS

COOKING WITH DOUBLE STACK PRO

Double Stack Pro allows you to cook 4 foods at once in 2 independent baskets. You can cook in both zones or just a single zone.

For detailed instructions on using **SMART FINISH** or **MATCH COOK**, see page 5.

When using these functions, Press **DOUBLE STACK PRO** before pressing either **SMART FINISH** or **MATCH COOK**.

When cooking in a single Zone, press **DOUBLE STACK PRO** before pressing **START/PAUSE**.

For detailed instructions on using each function, see pages 7-9.

PAUSING COOK TIME IN A SINGLE ZONE

- 1 Select the zone you want to pause.
- 2 Press the **START/PAUSE** button to pause cooking.
- 3 To resume cooking, press the **START/PAUSE** button.

NOTE: In **SMART FINISH** mode, we recommend pressing the **START/PAUSE** button to pause both zones. Pausing only one zone will impact a synchronized finish time.

ENDING COOK TIME IN A SINGLE ZONE (WHILE USING BOTH ZONES)

- 1 Select the zone you would like to stop cooking in.
- 2 Press the **TIME** button and turn dial to bring time down to zero.
- 3 After 3 seconds, **END** will appear on the display. Cooking will continue in the other zone.

COOKING IN YOUR AIR FRYER - CONT.

COOKING WITH DOUBLESTACK™ TECHNOLOGY

DoubleStack Technology utilizes two cooking zones to increase versatility. The Match Cook™ feature ensures that, regardless of different cook settings, both zones will finish cooking at the same time. For detailed instructions on using each function, see pages 7-8 or 9.

SMART FINISH

To finish cooking at the same time when foods have different cook times, temperatures, and/or functions:

- 1 Insert crisper plates in baskets, place ingredients in baskets, then insert baskets in unit.

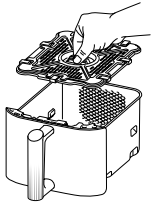

- 2 The unit will default to Zone 1. Turn the dial to select the desired cook function. Press the **TEMP** button, then turn the dial to set the temperature. Press the **TIME** button, then turn the dial to set the time.
- 3 Select Zone 2, then turn the dial to select the desired cook function. Press the **TEMP** button, then turn the dial to set the temperature. Press the **TIME** button, then turn the dial to set the time.

NOTE: You can select a different function for Zone 2.

- 4 Press **SMART FINISH**, then press **START/PAUSE** to begin cooking in the zone with the longest time. The other zone will display **HOLD**. The unit will beep and activate the second zone when both zones have the same cook time remaining.

NOTE: If you decide the food in one of the zones is finished cooking before the time reaches zero, you can stop cooking in that zone. Select that zone, then press **START/PAUSE**. See page 4 for further instructions.

- 5 When cooking is complete, the unit will beep and **COOL** will appear on the display for 60 seconds.
- 6 Remove ingredients by tipping them out or using silicone-tipped tongs/utensils. **DO NOT** place baskets on top of unit.

MATCH COOK

To cook a larger amount of the same food, or cook different foods using the same function, temperature, and time:

- 1 Insert crisper plates in baskets, place ingredients in baskets, then insert baskets in unit.

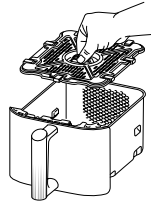

- 2 The unit will default to Zone 1. Turn the dial to select the desired cook function. Press the **TEMP** button, then turn the dial to set the temperature. Press the **TIME** button, then turn the dial to set the time.
- 3 Press the **MATCH COOK** button to copy Zone 1's settings to Zone 2. Press **START/PAUSE** to begin cooking in both zones.
- 4 When cooking is complete, the unit will beep and **COOL** will appear on the display for 60 seconds.
- 5 Remove ingredients by tipping them out or using silicone-tipped tongs/utensils. **DO NOT** place baskets on top of unit.

Starting both zones at the same time, but ending at different times:

- 1 Insert crisper plates in baskets, place ingredients in baskets, then insert baskets in unit.

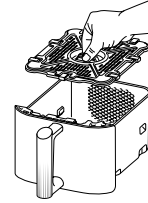

- 2 The unit will default to Zone 1. Turn the dial to select the desired cook function. Press the **TEMP** button, then turn the dial to set the temperature. Press the **TIME** button, then turn the dial to set the time.
- 3 Select Zone 2 and repeat step 2.
- 4 Press **START/PAUSE** to begin cooking in both zones.

NOTE: If you decide the food in one of the zones is finished cooking before the time reaches zero, you can stop cooking in that zone. Select that zone, then press **START/PAUSE**. See page 4 for further instructions.

- 5 When cooking is complete, the unit will beep and **COOL** will appear on the display for 60 seconds.
- 6 Remove ingredients by tipping them out or using silicone-tipped tongs/utensils. **DO NOT** place baskets on top of unit.

COOKING IN A SINGLE ZONE

To turn on the unit, plug the power cord into a wall socket, then press the power Ⓞ button.

Air Fry

NOTE: The default temperature is 390°F.

- 1 Insert a crisper plate in a basket, place ingredients in basket, then insert basket in unit.

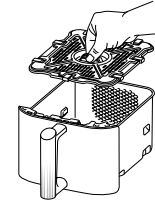

- 2 The unit will default to Zone 1 (you may select Zone 2 if you prefer). Turn the dial to select **AIR FRY**. Press the **TEMP** button, then turn the dial to set the temperature.
- 3 Press the **TIME** button, then turn the dial to set the time in 1-minute increments. Press **START/PAUSE** to begin cooking.

NOTE: During cooking, you can remove the basket and shake or toss ingredients for even crisping.

- 4 When cooking is complete, the unit will beep and **COOL** will appear on the display for 60 seconds.
- 5 Remove ingredients by tipping them out or using silicone-tipped tongs/utensils. **DO NOT** place baskets on top of unit.

COOKING IN YOUR AIR FRYER - CONT.

Air Broil

NOTE: The temperature is preset to 450°F. There is no temperature adjustment available or necessary when using the Air Broil function.

- 1 Insert a crisper plate in a basket, place ingredients in basket, then insert basket in unit.

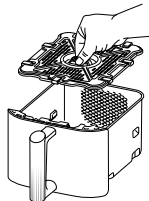

- 2 The unit will default to Zone 1 (you may select Zone 2 if you prefer). Turn the dial to select **AIR BROIL**.
- 3 Press the **TIME** button, then turn the dial to set the time in 1-minute increments. Press **START/PAUSE** to begin cooking.
- 4 When cooking is complete, the unit will beep and **COOL** will appear on the display for 60 seconds.
- 5 Remove ingredients by tipping them out or using silicone-tipped tongs/utensils. **DO NOT** place baskets on top of unit.

Bake

NOTE: The default temperature is 325°F.

- 1 Insert a crisper plate in a basket, place ingredients in basket, then insert basket in unit.

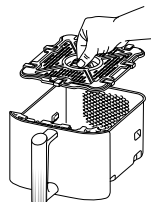

- 2 The unit will default to Zone 1 (you may select Zone 2 if you prefer). Turn the dial to select **BAKE**. Press the **TEMP** button, then turn the dial to set the temperature.

NOTE: To convert traditional oven recipes, reduce temperature by 25°F.

- 3 Press the **TIME** button, then turn the dial to set the time in 1-minute increments up to 1 hour and in 5-minute increments from 1 to 4 hours. Press **START/PAUSE** to begin cooking.
- 4 When cooking is complete, the unit will beep and **COOL** will appear on the display for 60 seconds.
- 5 Remove ingredients by tipping them out or using silicone-tipped tongs/utensils. **DO NOT** place baskets on top of unit.

Roast

NOTE: The default temperature is 250°F.

- 1 Insert a crisper plate in a basket, place ingredients in basket, then insert basket in unit.

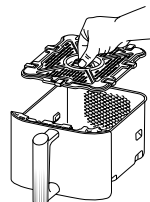

- 2 The unit will default to Zone 1 (you may select Zone 2 if you prefer). Turn the dial to select **REHEAT**. Press the **TEMP** button, then turn the dial to set the temperature.
- 3 Press the **TIME** button, then turn the dial to set the time in 1-minute increments up to 1 hour. Press **START/PAUSE** to begin reheating.
- 4 When reheating is complete, the unit will beep and **COOL** will appear on the display for 60 seconds.
- 5 Remove ingredients by tipping them out or using silicone-tipped tongs/utensils. **DO NOT** place baskets on top of unit.

Reheat

NOTE: The default temperature is 250°F.

- 1 Insert a crisper plate in a basket, place ingredients in basket, then insert basket in unit.

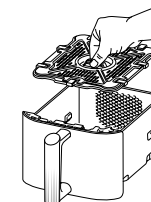

- 2 The unit will default to Zone 1 (you may select Zone 2 if you prefer). Turn the dial to select **REHEAT**. Press the **TEMP** button, then turn the dial to set the temperature.
- 3 Press the **TIME** button, then turn the dial to set the time in 1-minute increments up to 1 hour. Press **START/PAUSE** to begin reheating.
- 4 When reheating is complete, the unit will beep and **COOL** will appear on the display for 60 seconds.
- 5 Remove ingredients by tipping them out or using silicone-tipped tongs/utensils. **DO NOT** place baskets on top of unit.

COOKING IN YOUR AIR FRYER - CONT.

Dehydrate

NOTE: The default temperature is 140°F.

- 1 Insert a crisper plate in a basket, place ingredients in basket, then insert basket in unit.

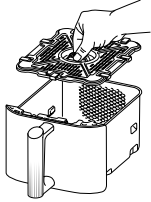

- 2 The unit will default to Zone 1 (you may select Zone 2 if you prefer). Turn the dial to select **DEHYDRATE**. Press the **TEMP** button, then turn the dial to set the temperature.
- 3 Press the **TIME** button, then turn the dial to set the time in 15-minute increments from 1 to 12 hours. Press **START/PAUSE** to begin dehydrating.
- 4 When dehydrating is complete, the unit will beep and **COOL** will appear on the display for 60 seconds.
- 5 Remove ingredients by tipping them out or using silicone-tipped tongs/utensils. **DO NOT** place baskets on top of unit.

CLEANING & MAINTENANCE

The unit should be cleaned thoroughly after every use. Unplug the unit from the outlet and wait until the unit is fully cooled before cleaning.

Part/ Accessory	Cleaning Method	Dishwasher Safe?
Main Unit	To clean the main unit and the control panel, wipe them clean with a damp cloth. NOTE: NEVER immerse the main unit in water or any other liquid. NEVER clean the main unit in a dishwasher.	No
Baskets, Crisper Plates, and Stacked Racks	These can be washed in the dishwasher or by hand. If hand-washing, air-dry or towel-dry all parts after use. <small>*To extend the life of the baskets, crisper plates, and racks, we recommend hand-washing them.</small>	Yes*

If food residue is stuck on the baskets, crisper plates, or racks, place them in a sink filled with warm, soapy water and allow to soak before washing.

HELPFUL TIPS

- 1 For consistent browning, make sure ingredients are arranged in an even layer on the bottom of the basket with no overlapping. If ingredients are overlapping, make sure to shake them halfway through the set cook time.
- 2 Cook temperature and time can be adjusted at any time during cooking. Simply select the Zone you want to adjust, then press the **TEMP** or **TIME** button and use the dial to make an adjustment.
- 3 To convert conventional oven recipes, reduce the temperature by 25°F. Check food frequently to avoid overcooking.
- 4 Occasionally, the fan from the air fryer will blow lightweight foods around. To alleviate this, secure foods (like the top slice of bread on a sandwich) with wooden toothpicks.
- 5 After selecting a cooking function, you can press **START/PAUSE** to begin cooking immediately. The unit will run at the default temperature and time.
- 6 For best results with fresh vegetables and potatoes, use at least 1 tablespoon of oil. Add more oil as desired to achieve the preferred level of crispiness.
- 7 For best results, check progress throughout cooking and remove food when desired level of brownness has been achieved. We recommend using an instant-read thermometer to monitor the internal temperature of meat and fish.
- 8 To avoid overcooking, remove food immediately after the cook time ends.

TROUBLESHOOTING GUIDE

- **How do I adjust the temperature or time while using a single zone?**
Select the active zone, then press **TEMP** and use the dial to adjust the temperature, or press **TIME** and use the dial to adjust the time.
- **How do I adjust the temperature or time while using DoubleStack™ Technology?**
Select the desired zone, press **TEMP** and use the dial to adjust the temperature, or press **TIME** and use the dial to adjust the time.
- **Does the unit need to preheat?**
No, the unit does not need to preheat.
- **Can I cook different foods in each zone and not worry about cross contamination?**
Yes, both zones are self-contained with separate heating elements and fans.
- **How do I pause the countdown timer?**
The countdown timer will pause automatically when you remove a basket from the unit. Reinsert basket within 10 minutes to resume cooking, or cooking in the zone with the basket not in place will be cancelled.
- **How do I stop cooking in one zone when using both zones?**
First press that zone's button, then press **START/PAUSE**. To stop both zones, simply press **START/PAUSE**.
- **Are the baskets safe to put on my countertop?**
The baskets will heat up during cooking, so use caution when handling. Place them on heat-resistant surfaces only.
- **When should I use the crisper plate(s)?**
Use the crisper plates when you want food to come out crispy. The plates elevate food in the baskets so that air can flow under and around ingredients to cook and crisp them evenly.
- **When should I use a stacked meal rack?**
Use a stacked meal rack when you want to cook two layers of food in one basket.
- **Why didn't my food cook fully?**
Make sure the basket is fully inserted during cooking. For consistent browning, ensure ingredients are arranged in an even layer in the basket with no overlapping. Shake basket to toss ingredients for even crispiness. Cook temperature and time can be adjusted at any time during cooking if you'd like to increase the temperature or cook food longer.
- **Why is my food burned?**
For best results, check food's progress throughout cooking and remove food when desired level of brownness has been achieved. To avoid overcooking, remove food immediately after the cook time ends.
- **Why do some ingredients blow around when air frying?**
Occasionally, the fan from the air fryer will blow lightweight foods around. Use wooden toothpicks to secure loose lightweight food, like the top slice of bread on a sandwich.
- **Can I air fry wet, battered ingredients?**
Yes, but use the proper breading technique. It's important to coat foods first with flour, then with egg, and then with breadcrumbs. Press breadcrumbs firmly onto the battered ingredients, so crumbs won't be blown off by the fan.
- **Why is the unit beeping?**
Either the cook time has ended, or the other zone has started cooking (when using the Smart Finish™ feature).
- **Why did the display screen go black?**
The unit is in standby mode. Press the Power Ⓞ button to turn it back on.
- **Why is there an "E" message on the display screen?**
The unit is not functioning properly. Please contact Customer Service at 1-877-646-5288.
- **Why is there an "O-H" message on the display screen?**
The unit is overheating because it is positioned in a corner or constricted space. This appliance requires at least 6 inches (15.25 cm) of space on the top and sides for air circulation. For the unit to function normally again, turn it off and unplug it. Allow it to cool down for 30 minutes, then move it to a space that provides 6 inches of clearance on the top and sides. Additionally, ensure there is no other heating source in close proximity to the unit.

Shark | NINJA

ONE (1) YEAR LIMITED WARRANTY

NJA_1_YR_IB_LMTD_WRTNY_US_ENG

The One (1) Year Limited Warranty applies to purchases made from authorized retailers of **SharkNinja Operating LLC**. Warranty coverage applies to the original owner and to the original product only and is not transferable.

SharkNinja warrants that the unit shall be free from defects in material and workmanship for a period of one (1) year from the date of purchase when it is used under normal household conditions and maintained according to the requirements outlined in the Owner's Guide, subject to the following conditions and exclusions:

What is covered by this warranty?

1. The original unit and/or non-wearable parts deemed defective, in SharkNinja's sole discretion, will be repaired or replaced up to one (1) year from the original purchase date.
2. In the event a replacement unit is issued, the warranty coverage ends six (6) months following the receipt date of the replacement unit or the remainder of the existing warranty, whichever is later. SharkNinja reserves the right to replace the unit with one of equal or greater value.

What is not covered by this warranty?

1. Normal wear and tear of wearable parts (such as blending vessels, lids, cups, blades, blender bases, removable pots, racks, pans, etc.), which require regular maintenance and/or replacement to ensure the proper functioning of your unit, are not covered by this warranty. Replacement parts are available for purchase at ninjaaccessories.com.
2. Any unit that has been tampered with or used for commercial purposes.
3. Damage caused by misuse, abuse, negligent handling, failure to perform required maintenance (e.g., failure to keep the well of the motor base clear of food spills and other debris), or damage due to mishandling in transit.
4. Consequential and incidental damages.
5. Defects caused by repair persons not authorized by SharkNinja. These defects include damages caused in the process of shipping, altering, or repairing the SharkNinja product (or any of its parts) when the repair is performed by a repair person not authorized by SharkNinja.
6. Products purchased, used, or operated outside North America.

How to get service

If your appliance fails to operate properly while in use under normal household conditions within the warranty period, visit ninjakitchen.com/support for product care and maintenance self-help. Our Customer Service Specialists are also available at **1-877-646-5288** to assist with product support and warranty service options, including the possibility of upgrading to our VIP warranty service options for select product categories. So we may better assist you, please register your product online at registeryourninja.com and have the product on hand when you call.

SharkNinja will cover the cost for the customer to send in the unit to us for repair or replacement. A fee of \$20.95 (subject to change) will be charged when SharkNinja ships the repaired or replacement unit.

How to initiate a warranty claim

You must call **1-877-646-5288** to initiate a warranty claim. You will need the receipt as proof of purchase. We also ask that you register your product online at registeryourninja.com and have the product on hand when you call, so we may better assist you. A Customer Service Specialist will provide you with return and packing instruction information.

How state law applies

This warranty gives you specific legal rights, and you also may have other rights that vary from state to state. Some states do not permit the exclusion or limitation of incidental or consequential damages, so the above may not apply to you.

