



# SLUSHI™ PROFESSIONAL FROZEN DRINK MAKER WITH RAPIDCHILL TECHNOLOGY

FS301 Series | Owner's Guide



## IMPORTANT SAFETY INSTRUCTIONS

PLEASE READ ALL INSTRUCTIONS BEFORE USE • FOR HOUSEHOLD USE ONLY

	<b>Read and review instructions for operation and use.</b>
	<b>Indicates the presence of a hazard that can cause personal injury, death, or substantial property damage if the warning included with this symbol is ignored.</b>
	<b>Combustible material. May burst if heated. (Indicated by a flame symbol with white background, surrounded by a red diamond.)</b>
	<b>Flammable material. (Indicated by a flame symbol with yellow background, surrounded by a black triangle.)</b>
	<b>For indoor and household use only.</b>
<b>When using electrical appliances, basic safety precautions should always be followed, including the following:</b>	

**⚠DANGER:** Risk of fire or explosion. Flammable refrigerant used. **DO NOT** puncture refrigerant tubing. Dispose of product properly in accordance with the applicable federal or local regulations pertaining to flammable refrigerants.

**⚠WARNING:** To reduce the risk of injury, fire, electrical shock or property damage, basic safety precautions must always be followed, including the following numbered warnings and subsequent instructions. **DO NOT** use appliance for other than intended use.

- 1 Read all instructions prior to using the appliance and its accessories.
- 2 Carefully observe and follow all warnings and instructions. This unit contains electrical connections and moving parts that potentially present risk to the user.
- 3 Take inventory of all contents to ensure you have all parts needed to properly and safely operate your appliance.
- 4 Turn the appliance **OFF**, then unplug the appliance from the outlet when not in use, before assembling or disassembling parts, and before cleaning. To unplug, grasp the plug by the body and pull from the outlet. **NEVER** unplug by grasping and pulling the flexible cord.
- 5 Before use, wash all parts that may contact food. Follow washing instructions covered in this instruction manual.
- 6 **DO NOT** operate any appliance with a damaged cord or plug, or after the appliance malfunctions or is dropped or damaged in any manner. This appliance has no user-serviceable parts. If damaged, contact SharkNinja for servicing.
- 7 This appliance has important markings on the plug. The entire supply cord is not suitable for replacement. If damaged, please contact SharkNinja for service.
- 8 Extension cords should **NOT** be used with this appliance.
- 9 To protect against the risk of electric shock, **DO NOT** submerge the appliance or allow the power cord to contact any form of liquid.
- 10 **DO NOT** allow the cord to hang over the edges of tables or counters. The cord may become snagged and pull the appliance off the work surface.
- 11 **DO NOT** allow the unit or the cord to contact hot surfaces, including stoves, and other heating appliances.
- 12 **ALWAYS** use the appliance on a dry and level surface.
- 13 **DO NOT** allow children to operate this appliance or use as a toy. Close supervision is necessary when any appliance is used near children.

# IMPORTANT SAFETY INSTRUCTIONS

PLEASE READ ALL INSTRUCTIONS BEFORE USE • FOR HOUSEHOLD USE ONLY

- 14 This appliance is **NOT** intended to be used by people with reduced physical, sensory, or mental capabilities, or lack of experience and knowledge, unless they have been given supervision or instruction concerning use of the appliance by a person responsible for their safety.
- 15 **ONLY** use attachments and accessories that are provided with the product or are recommended by SharkNinja. The use of attachments not recommended or sold by SharkNinja may cause fire, electric shock, or injury.
- 16 Keep hands, hair, and clothing out of the container when loading and operating.
- 17 During operation and handling of the appliance, avoid contact with moving parts.
- 18 **DO NOT** microwave the containers or accessories provided with the appliance.
- 19 **ALWAYS** keep ventilation openings, in the appliance enclosure or in the built-in structure, clear of obstruction.
- 20 **DO NOT** use mechanical devices or other means to accelerate the defrosting process, other than those recommended by the manufacturer.
- 21 **DO NOT** damage the refrigerant circuit. This warning is only applicable for appliances with refrigerating circuits which are accessible by the user.
- 22 **DO NOT** use electrical appliances inside the food storage compartments of the appliance, unless they are of the type recommended by the manufacturer.
- 23 **DO NOT** add frozen fruit, frozen vegetables, or ice to the unit.
- 24 **DO NOT** add hot ingredients to the unit.
- 25 **DO NOT** submerge the motor base or control panel in water or other liquids.
- 26 **DO NOT** fill vessel past the MAX FILL line.
- 27 **NEVER** leave the appliance unattended while in use.
- 28 Before operation, ensure all utensils are removed from containers. Failure to remove utensils can cause containers to shatter and potentially result in personal injury and property damage.
- 29 **DO NOT** carry the unit by the bail handle. Hold the unit by grasping both sides of the unit under the motor base.
- 30 **DO NOT** process hard, loose ingredients or ice. This appliance is not intended to process loose frozen fruit, a block of solid ice, or ice cubes.
- 31 **ALWAYS** keep the unit upright.
- 32 After unboxing the unit for the first time, ensure the unit is upright for at least 2 hours before operating to let the refrigerant oils settle in the air conditioning system for best performance.
- 33 This appliance is not intended for use by persons (including children) with reduced physical, sensory or mental capabilities, or lack of experience and knowledge, unless they have been given supervision or instruction concerning use of the appliance by a person responsible for their safety. Children should be supervised to ensure that they do not play with the appliance.
- 34 The supply cord cannot be replaced. If the cord is damaged the appliance should be scrapped.
- 35 Keep rear and sides of the unit open in order for the compressor to operate properly and not over heat.
- 36 Keep ventilation openings, in the appliance enclosure or in the built-in structure, clear of obstruction.
- 37 **DO NOT** use mechanical devices or other means to accelerate the defrosting process, other than those recommended by the manufacturer.
- 38 **DO NOT** damage the refrigerant circuit. This warning is applicable only for appliances with refrigerating circuits that are accessible by the user.
- 39 When using appliance, make sure both sides and back of it are at least four inches away from walls.

## SAVE THESE INSTRUCTIONS

## PARTS

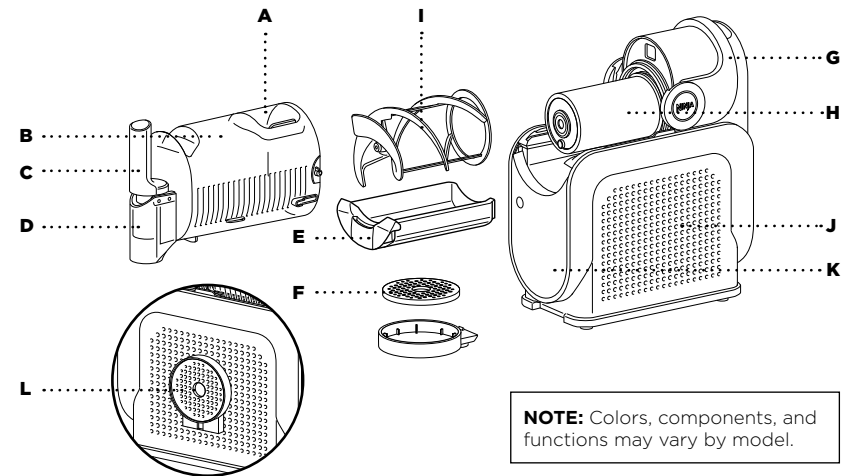

- |   |  |
|---|--|
| <b>A</b> Easy-Fill Port and Cover         | <b>G</b> Bail Handle                                 |
| <b>B</b> Vessel*                          | <b>H</b> Evaporator (Attached to Motor Base)         |
| <b>C</b> Comfort Handle                   | <b>I</b> Auger                                       |
| <b>D</b> Pour Spout with Removable Shroud | <b>J</b> Motor Base                                  |
| <b>E</b> Condensation Catch               | <b>K</b> Control Panel                               |
| <b>F</b> 2-Part Drip Tray                 | <b>L</b> Drip Tray Storage (Left side of Motor Base) |

\*16-oz minimum liquid capacity. 64-oz maximum liquid capacity.

To find great recipes, visit [ninjakitchen.com](http://ninjakitchen.com).

## BEFORE FIRST USE

**IMPORTANT:** Review all warnings at the beginning of this Owner's Guide before proceeding.

- 1 Remove all packaging materials from the unit.
- 2 Wash all parts in warm, soapy water.
- 3 Thoroughly rinse and air-dry all parts.
- 4 Wipe control panel, motor base, and evaporator with a soft cloth. Allow to dry completely before using.
- 5 **Place the unit on countertop for at least 2 hours before operating. This allows the refrigerant to settle in the condenser for optimal and safe use.**

**NOTE:** All attachments are BPA free. Accessories are dishwasher safe but should **NOT** be cleaned with a heated dry cycle.

## USING THE CONTROL PANEL

### POWER

- Press to power the unit on and off.

### RINSE CYCLE

- This cycle agitates, without cooling, to rinse the unit.

### PRESETS

- 5 unique presets use RapidChill Technology to determine the perfect temperature for the ideal frozen drink.

### TEMPERATURE CONTROL SETTING

- Each preset will start at a default/optimal temperature for ideal texture. If desired, adjust the temperature for your perfect frozen drink texture.
- For sippable frozen drinks, decrease the temperature level by pressing the bottom arrow on the control panel.
- For thicker, colder frozen drinks, increase the temperature level by pressing the top arrow on the control panel.

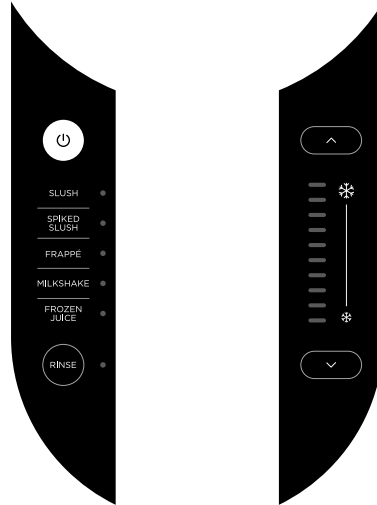

### TROUBLESHOOTING TIPS

- **RECIPE NOT SLUSHING?** If your recipe has not reached desired texture after 60 minutes, increase the temperature by one level. Wait 10–15 minutes to test recipe texture. If still not desired, increase by one level again. Repeat until desired texture is achieved.
- **SLUSH NOT DISPENSING?** For the best dispensing experience, fill the unit to the max fill line and ensure the unit is running. For a smoother dispense experience, decrease the temperature level by pressing the bottom arrow on the control panel. More sippable frozen drinks will dispense smoother.

## PRESETS

Each preset will start at a default/optimal temperature for ideal texture. If desired, adjust the temperature for your perfect frozen drink texture.

PRESET	DEFAULT/OPTIMAL TEMPERATURE	DESIGNED FOR	RECIPE EXAMPLES
SLUSH		Transforming your everyday beverages	Soda, lemonade
SPIKED SLUSH		Beverages with alcohol content	Margarita, rosé
FRAPPÉ		Coffee shop lovers to make frozen treats	Store-bought frappé
MILKSHAKE		Dairy- and creamier-based beverages	Chocolate milk, blended milkshake
FROZEN JUICE		Naturally sweetened beverages	Orange juice, apple cider

## REQUIRED SUGAR CONTENT

Too little sugar or too much alcohol will prevent proper freezing of a slush output. Follow guidelines below for a perfect slush every time.

All inputs must contain at least 4% sugar.

**NOTE:** Pre-frozen ingredients taste sweeter. Worried your drink might be too sweet? Don't worry, it won't taste as sweet after you freeze and slush it into a frozen drink.

### SUGAR GUIDELINES

Refer to drink/liquid nutrition label to ensure sugar content meets the recommended minimums below:

SERVING SIZE	Minimum Total Sugar Amount
8 oz (240 ml)	8 g
12 oz (355 ml)	11 g
20 oz (591 ml)	18 g

### EXAMPLE: Apple juice

Nutrition Facts	
8 Servings per container	
Serving size	8 fl oz (240 ml)
Amount per serving	
<b>Calories</b>	<b>120</b>
% Daily Value*	
Total Fat 0g	0%
Sodium 25mg	1%
Total Carbohydrate 31g	11%
Total Sugars 26g	
Protein 0g	
Potassium 251mg	6%
Vitamin C 108mg	120%
Not a significant source of saturated fat, trans fat, cholesterol, dietary fiber, added sugars, vitamin D, calcium and iron.	
* The % Daily Value (DV) tells you how much a nutrient in a serving of food contributes to a daily diet. 2,000 calories a day is used for general nutrition advice.	

Serving Size

Total Sugars  
(26 g meets the minimum requirements)

### TROUBLESHOOTING TIPS

**Low-sugar alert:** If the sugar content of the input is too low, the unit will detect it and provide an alert. Temperature Control LEDs will flash one at a time in descending order starting with the top LED, preset LEDs will flash, and the unit will beep every minute for 15 minutes.

**If a drink does not meet minimum requirements of total sugar:** Add 1–2 tablespoons flavored syrup, juice, sugar, date sugar, coconut sugar, maple syrup, agave, simple syrup, or honey per serving. Combine additional sugar with the base prior to pouring in unit. Reset the unit by pressing the preset. Restart by pressing the preset again.

**NOTE:** Sugar-free substitutes or artificial sweeteners will not aid in meeting total minimum or maximum sugar requirements.

## ALCOHOL GUIDELINES

The perfect balance for your favorite frozen cocktails at home. When using the SPIKED SLUSH preset, all premade inputs (wine, beer, etc.) must be between 2.8% and 16% alcohol.

### HARD ALCOHOL/SPIRIT GUIDELINES

To create frozen cocktails, see chart below for the maximum hard alcohol/spirit (vodka, tequila, etc.) content per total recipe size.

Total Recipe Size	Maximum Alcohol Amount
3 cups (24 oz)	1/2 cup (4 oz)
4 1/2 cups (36 oz)	3/4 cup (6 oz)
6 cups (48 oz)	1 cup (8 oz)
8 cups (64 oz)	1 1/4 cup (10 oz)

Chart above is a guide for incorporating hard alcohol/spirits (35%+) **ONLY**. When using other alcohols such as wine, beer, seltzer, or premade cocktails, refer to the Inspiration Guide.

### TROUBLESHOOTING TIPS

**High-alcohol/high-sugar alert:** If the alcohol and sugar content of the input is too high, the unit will detect it and provide an alert. Temperature Control LEDs will flash one at a time in ascending order starting with the bottom LED, preset LEDs will flash, and the unit will beep every minute for 15 minutes.

**If a drink exceeds the maximum alcohol amount:** Add 1/4 cup water; soda; tonic water; seltzer; or plain, chilled coffee/tea per serving to dilute the input. Reset the unit by pressing the preset. Restart by pressing the preset again.

## TIPS & TRICKS

- Keep unit upright for at least 2 hours before first use.
- **DO NOT** add hot ingredients.
- **DO NOT** add ice or solid ingredients like fruit, ice cream, or frozen fruit.
- Pre-frozen ingredients taste sweeter. Worried your drink might be too sweet? Don't worry, it won't taste as sweet after you freeze and slush it into a frozen drink.
- All inputs must include at least 4% sugar.
- When using the Spiked Slush preset, all premade inputs must contain between 2.8% and 16% alcohol.
- For best results, chill liquid(s) or blended ingredients before adding to the unit.
- For the frostiest results, chill serving glasses before dispensing your frozen drink.
- For your ideal frozen drink texture, use the temperature control setting to adjust.
- When using the Milkshake or Frappé preset, dispense contents within 30 minutes of the preset ending to avoid a foamy output.
- For the best dispensing experience, fill the unit to the max-fill line (64 oz).
- You can run the unit up to 12 hours.
- All parts except the motor base, including the evaporator, are dishwasher safe but should **NOT** be cleaned with a heated dry cycle.

**Minimum input = 2 cups (16 oz) Maximum input = 8 cups (64 oz)**

**This is NOT a blender.**

**DO NOT** process a solid block of ice or ice cubes.

**DO NOT** make a smoothie or process hard, loose ingredients.

**DO NOT** attempt to blend or macerate non-liquid ingredients.

## USING THE NINJA SLUSHI™ PROFESSIONAL FROZEN DRINK MAKER

**IMPORTANT:** Review all warnings at the beginning of this Owner's Guide before proceeding.

### NOTE:

- Minimum 16-oz input required for using the unit.
- Maximum 64-oz liquid capacity.
- **DO NOT** add ice or solid ingredients like fruit, ice cream, or frozen fruit.
- **DO NOT** add hot ingredients.

- 1 Ensure all parts are fully cleaned and the motor base is level on a flat, solid surface.
- 2 Install the condensation catch under the evaporator by sliding it into the rail grooves.

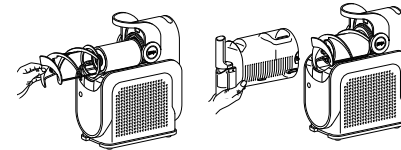
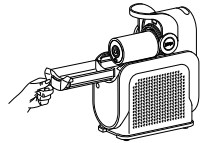

- 3 Install the auger by sliding it over the evaporator and rotating until it fits into place onto the pin.
- 4 With the bail handle up, slide the vessel over the installed auger and evaporator.

- 5 Lock the vessel in place by pushing the bail handle back to seal the vessel.
- 6 Insert the drip tray in front of the motor base until it clicks in place.

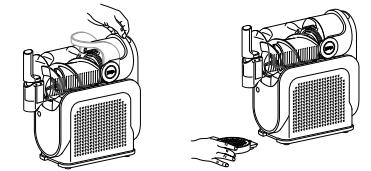

**NOTE:** Make sure the unit has been sitting upright on the countertop for at least 2 hours before first use, so the refrigerant can settle in the condenser for optimal and safe use.

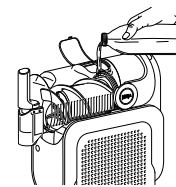

- 7 Plug the unit in.
- 8 Open the cover on the top of the vessel.
- 9 Add liquid(s) and/or blended ingredients through the easy-fill port and close the cover.
- 10 Press the power button to turn the unit on.

- 11 Choose your desired preset.
- 12 The preset will start at the default/optimal temperature for ideal texture. If desired, adjust the temperature for your perfect frozen drink texture.

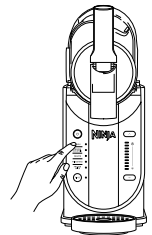

### NOTE:

- Temperature Control Setting LEDs will pulse while frozen drink is freezing to your set temperature level. Once frozen drink reaches the desired temperature, LEDs will remain solid and unit will beep. Unit will continue running to keep your frozen drink at the ideal temperature and be ready to dispense.
- Creating drinks can take up to 15-60 minutes depending on ingredients, volume, and starting temperature.
- Pre-frozen ingredients taste sweeter. Worried your drink might be too sweet? Don't worry, it won't taste as sweet after you freeze and slush it into a frozen drink.

## USING THE NINJA SLUSHI™ PROFESSIONAL FROZEN DRINK MAKER — CONT.

- Place a cup on the drip tray, under the handle.
- To dispense, slowly pull the handle. To stop, release the handle back in place.
- Enjoy your latest frozen drink creation.
- Run the unit for up to 12 hours.

**NOTE:** DO NOT turn off preset until all frozen drink has been dispensed.

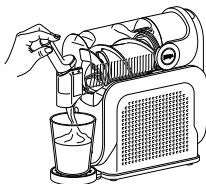

## CARE & MAINTENANCE

### USING THE RINSE CYCLE

**NOTE:** Liquids from rinsing will dispense quickly from vessel pour spout. Ensure you use a large cup or bowl to capture this liquid.

This cycle agitates, without cooling, to rinse the unit. After using the Rinse cycle, wash all parts by hand or in a dishwasher to fully clean the unit after each use.

- Dispense any remaining frozen drink.
- Stop the current preset. Press the RINSE button.
- Add hot water up to the vessel's max fill line (64 oz).
- Slowly dispense the water from the unit immediately after filling.
- Stop Rinse cycle by pressing the RINSE button again.
- Press the power button to turn the unit off.

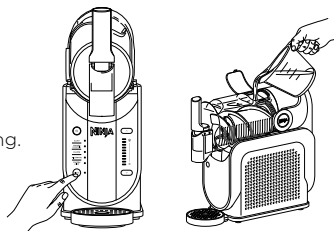

**NOTE:** If needed, repeat until frozen drink is rinsed off the evaporator.

### DISASSEMBLY & CLEANING

For best results, use the Rinse cycle before disassembling and cleaning all parts.

- Unlock the bail handle by pulling forward and remove the vessel by gently pulling it off the unit. Ensure the vessel is tipped downward to prevent remaining liquid from spilling out the back of the vessel. Set aside.
- Slide the auger off the evaporator. Set aside.

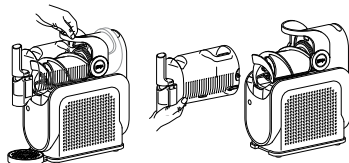

- Wipe down the evaporator with a sanitized or warm, damp cloth.
- Gently slide the condensation catch out of the unit, since there may be residual liquid in the condensation catch. Set aside.
- Wipe down unit underneath the evaporator with a sanitized or warm, damp cloth.
- If needed, remove the drip tray and/or spout shroud.

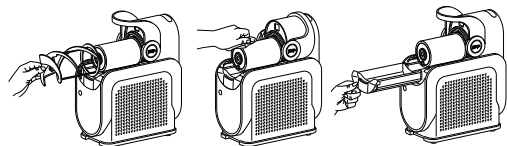

**NOTE:** Drip tray cover can be removed for easy cleaning.

- Hand-wash all parts in hot, soapy water, or use a dishwasher. If needed, repeat until all parts are fully clean.

**NOTE:** All parts, except the motor base and evaporator, are bottom-rack dishwasher safe, and should **NOT** be cleaned with a heated dry cycle.

- Wipe down the motor base with a sanitized or warm, damp cloth.
- Allow all parts to dry thoroughly before reassembling and/or storing the unit.

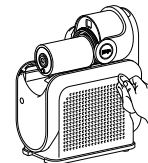

### STORING

For cord storage, wrap cord with the hook-and-loop fastener near the back of the motor base. **DO NOT** wrap the cord around the bottom of the base. Store the unit upright and store all parts assembled. Store the drip tray on the left side of the unit by hanging it in place. When moving the unit, lift from the bottom of the motor base.

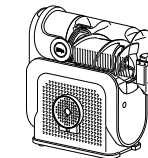

**DO NOT** store ingredients inside the vessel.

### RESETTING THE MOTOR

This unit features a unique safety system that prevents damage to the motor and drive system should you inadvertently overload it. If the unit is overloaded, the motor will be temporarily disabled. Should this occur, follow the reset procedure below.

- Unplug the unit from the electrical outlet.
- Allow the unit to cool for approximately 15 minutes.
- Remove all parts and accessories. Ensure no ingredients are jamming the auger.

**IMPORTANT:** Ensure that maximum capacity is not exceeded. This is the most typical cause of appliance overload.

**DO NOT** process a solid block of ice or ice cubes. **DO NOT** make a smoothie or process hard, loose ingredients. If your unit needs servicing, please call Customer Service at 1-877-646-5288. So we may better assist you, please register your product online at [registryourninja.com](http://registryourninja.com) and have the product on hand when you call.

## ORDERING REPLACEMENT PARTS

To order additional parts and attachments, visit [ninjaaccessories.com](http://ninjaaccessories.com).

## PRODUCT REGISTRATION

Please visit [registryourninja.com](http://registryourninja.com) to register your new Ninja product within ten (10) days of purchase. You will be asked to provide the store name, date of purchase, and model number along with your name and address.

The registration will enable us to contact you in the unlikely event of a product safety notification. By registering, you acknowledge you have read and understood the instructions for use and warnings set forth in the accompanying instructions.

## TROUBLESHOOTING GUIDE

**⚠️ WARNING:** To reduce the risk of shock and unintended operation, turn power off and unplug unit before troubleshooting.

**Unit is difficult to remove from counter for storage.**

- Place your hands underneath both sides of the motor base and gently pull the unit up and toward you.

**Can I add frozen fruit or ice?**

- No. **DO NOT** add frozen ingredients or ice when using this unit.

**Vessel not installed alert: If the vessel is not installed correctly, the unit will detect it and provide an alert. All preset LEDs will flash.**

- With the bail handle up, slide the vessel over the installed auger and evaporator.
- Lock the vessel in place by pushing the bail handle back to seal the vessel.
- Press the Power button to turn unit on, and the preset LEDs will illuminate, indicating the unit is ready for use.

**Low-sugar alert: If the sugar content of the input is too low, the unit will detect it and provide an alert. Temperature Control LEDs will flash one at a time in descending order starting with the top LED, preset LEDs will flash, and the unit will beep every minute for 15 minutes.**

- Check the sugar content in your recipe to ensure it contains at least 4% sugar.
- If using a premade beverage, check the ingredient list to ensure the sugar content is at least 4% and ensure the beverage doesn't include artificial sweeteners. Refer to the Required Sugar Content section for more details.
- If a drink does not meet minimum requirements of total sugar, add 1-2 tablespoons flavored syrup, juice, sugar, date sugar, coconut sugar, maple syrup, agave, simple syrup, or honey per serving.
- Reset the unit by pressing the preset. Restart by pressing the preset again to resume creating your frozen drink.

**High-alcohol/high-sugar alert: If the alcohol and sugar content of the input is too high, the unit will detect it and provide an alert. Temperature Control LEDs will flash one at a time in ascending order starting with the bottom LED, preset LEDs will flash, and the unit will beep every minute for 15 minutes.**

- Check the alcohol content in your recipe to ensure it contains between 2.8% and 16% alcohol.
- If using hard alcohol/spirits (35%+), use 4 oz for every 24 oz of total recipe size. Refer to the Alcohol Guidelines section for more details.
- If a drink exceeds the maximum alcohol amount, add 1/4 cup water, soda, tonic water, seltzer, or coffee/tea per serving to dilute the input.
- Reset the unit by pressing the preset. Restart by pressing the preset again to resume creating your frozen drink.

**Motor stall alert: If the motor stalls while running, the unit will detect it and provide an alert. Every Temperature Control LED will flash, and the unit will beep every minute for 15 minutes.**

- This unit features a unique safety system that prevents damage to the motor and drive system should you inadvertently overload it. If the unit is overloaded, the motor will be temporarily disabled.
- Unplug the unit from the electrical outlet.
- Allow the unit to cool for approximately 15 minutes.
- Remove all parts and accessories. Ensure no ingredients are jamming the auger.
- Plug in the unit again and reassemble all parts to resume unit use.

**Unit failure alert: If the unit fails, the unit will detect it and provide an alert. Every other Temperature Control LED will flash alternately, and the unit will beep every minute for 15 minutes.**

- If the unit fails, please call Customer Service at 1-877-646-5288.

**Unit sideways alert: If the unit is on its side during use, the unit will detect it and provide an alert. The top 5 and bottom 5 Temperature Control LEDs will flash alternately, and the unit will beep every minute for 15 minutes.**

- Place the unit upright and let it stand for at least 2 hours before using.

# Shark | NINJA

**ONE (1) YEAR LIMITED WARRANTY**

NJA\_1\_YR\_IB\_LMTD\_WRNTY\_US\_ENG

The One (1) Year Limited Warranty applies to purchases made from authorized retailers of **SharkNinja Operating LLC**. Warranty coverage applies to the original owner and to the original product only and is not transferable.

SharkNinja warrants that the unit shall be free from defects in material and workmanship for a period of one (1) year from the date of purchase when it is used under normal household conditions and maintained according to the requirements outlined in the Owner's Guide, subject to the following conditions and exclusions:

**What is covered by this warranty?**

1. The original unit and/or non-wearable parts deemed defective, in SharkNinja's sole discretion, will be repaired or replaced up to one (1) year from the original purchase date.
2. In the event a replacement unit is issued, the warranty coverage ends six (6) months following the receipt date of the replacement unit or the remainder of the existing warranty, whichever is later. SharkNinja reserves the right to replace the unit with one of equal or greater value.

**What is not covered by this warranty?**

1. Normal wear and tear of wearable parts (such as blending vessels, lids, cups, blades, blender bases, removable pots, racks, pans, etc.), which require regular maintenance and/or replacement to ensure the proper functioning of your unit, are not covered by this warranty. Replacement parts are available for purchase at [ninjaaccessories.com](http://ninjaaccessories.com).
2. Any unit that has been tampered with or used for commercial purposes.
3. Damage caused by misuse, abuse, negligent handling, failure to perform required maintenance (e.g., failure to keep the well of the motor base clear of food spills and other debris), or damage due to mishandling in transit.
4. Consequential and incidental damages.
5. Defects caused by repair persons not authorized by SharkNinja. These defects include damages caused in the process of shipping, altering, or repairing the SharkNinja product (or any of its parts) when the repair is performed by a repair person not authorized by SharkNinja.
6. Products purchased, used, or operated outside North America.

**How to get service**

If your appliance fails to operate properly while in use under normal household conditions within the warranty period, visit [ninjakitchen.com/support](http://ninjakitchen.com/support) for product care and maintenance self-help. Our Customer Service Specialists are also available at **1-877-646-5288** to assist with product support and warranty service options, including the possibility of upgrading to our VIP warranty service options for select product categories. So we may better assist you, please register your product online at [registeryourninja.com](http://registeryourninja.com) and have the product on hand when you call.

SharkNinja will cover the cost for the customer to send in the unit to us for repair or replacement. A fee of \$20.95 (subject to change) will be charged when SharkNinja ships the repaired or replacement unit.

**How to initiate a warranty claim**

You must call **1-877-646-5288** to initiate a warranty claim. You will need the receipt as proof of purchase. We also ask that you register your product online at [registeryourninja.com](http://registeryourninja.com) and have the product on hand when you call, so we may better assist you. A Customer Service Specialist will provide you with return and packing instruction information.

**How state law applies**

This warranty gives you specific legal rights, and you also may have other rights that vary from state to state. Some states do not permit the exclusion or limitation of incidental or consequential damages, so the above may not apply to you.



## REGISTER YOUR PURCHASE



registeryourninja.com



Scan QR code using mobile device

## RECORD THIS INFORMATION

Model Number: \_\_\_\_\_

Serial Number: \_\_\_\_\_

Date of Purchase: \_\_\_\_\_  
(Keep receipt)

Store of Purchase: \_\_\_\_\_

## TECHNICAL SPECIFICATIONS

Voltage: 120V-, 60Hz

Power: 200 Watts

**SharkNinja Operating LLC**  
**US: Needham, MA 02494**  
**CAN: Ville St-Laurent, QC H4S 1A7**  
**1-877-646-5288**  
**ninjakitchen.com**

Illustrations may differ from actual product. We are constantly striving to improve our products, therefore the specifications contained herein are subject to change without notice.

NINJA SLUSHI is a trademark of SharkNinja Operating LLC.

This product may be covered by one or more U.S. patents. See [sharkninja.com/patents](https://sharkninja.com/patents) for more information.

© 2024 SharkNinja Operating LLC

FS301Series\_IB\_MP\_Mv19



**@ninjakitchen**