

NINJA

LUXE CAFÉ

QUICK START GUIDE

Follow these steps to get set up, make your first drink, and care for your machine.

Or scan for easy 3D instructions

Tap. Zoom. Rotate with official interactive instructions on the BILT app.



BILT.

Download on the App Store

GET IT ON Google Play

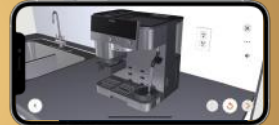

STEP 1: MEET YOUR TOOLS REQUIRED TO GET STARTED



SCAN HERE for how-to videos & quick tips



ASSISTED TAMPER

Designed to apply the right amount of even pressure for the perfect puck.

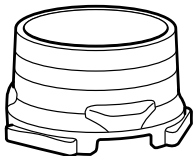

FUNNEL

Prevents grounds from overflowing when grinding and assists tamping. **Always install funnel before grinding.**

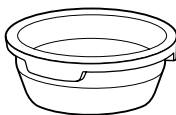

DOUBLE BASKET

Used to brew espresso. **Comes installed in the portafilter.**

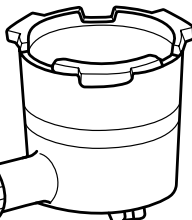

PORTAFILTER

Holds basket in place for grinding and brewing.

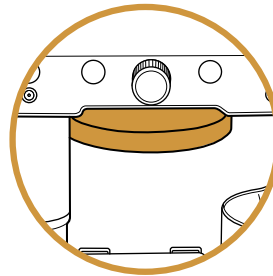

GROUP HEAD

Install portafilter here for brewing.

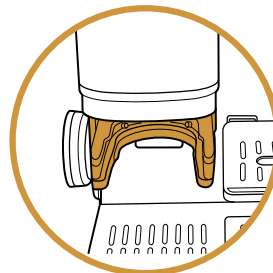

GRINDING CRADLE

Install portafilter and funnel here when grinding beans.

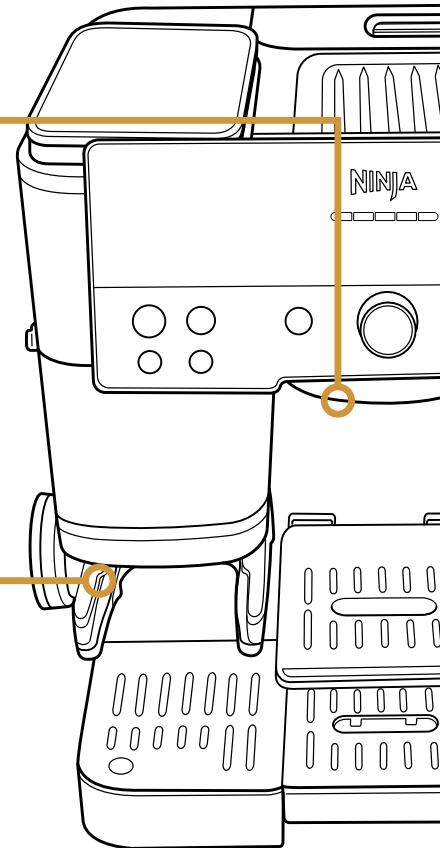

STEP 2: TEST WATER HARDNESS

BE SURE TO THOROUGHLY CLEAN AND DRY ALL ITEMS BEFORE PROCEEDING.

All water has minerals that can build up in the machine over time. These minerals are referred to as water hardness and can impact how often you need to descale your machine.

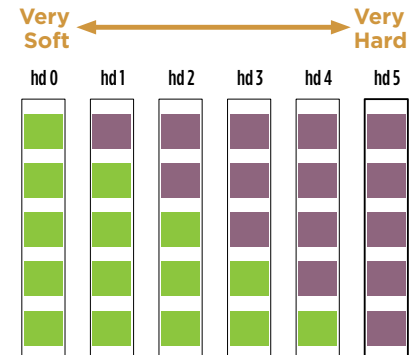
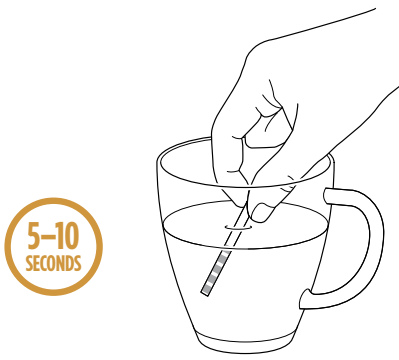

Locate test strip provided in starter kit. Completely submerge test strip in the water you plan on using with your machine for 5-10 seconds, ensuring all squares are underwater.

Remove from water and place on a flat surface. Wait 1 minute and check results.

After 1 minute, you will see 0-5 purple squares appear. This will indicate the water hardness level of your water (0 purple squares=level 0, 5 purple squares=level 5, etc.).

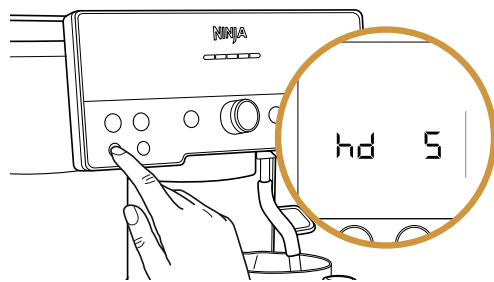

Plug in machine. Press power button to turn the machine on. The control panel will display a water hardness of hd 5.

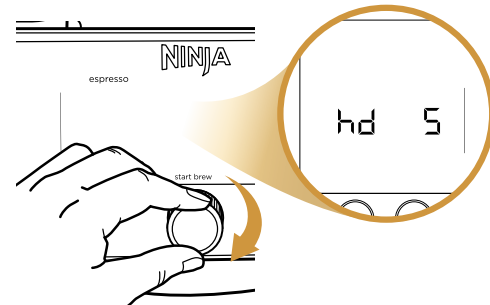

Turn the center dial to set your water hardness by matching your setting to how many purple squares you see (will range from 0-5 squares). Press center dial to confirm your setting.*

*IF YOU NEED TO SET YOUR WATER HARDNESS LEVEL AGAIN, SEE OWNER'S GUIDE.

STEP 3: FILL WATER RESERVOIR & BEAN HOPPER

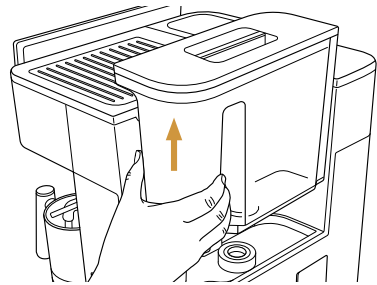

Remove water reservoir from back of machine.

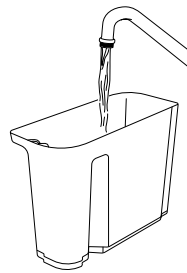

Fill with room-temperature or cold water up to, but not exceeding, the max line. Place reservoir back on machine.

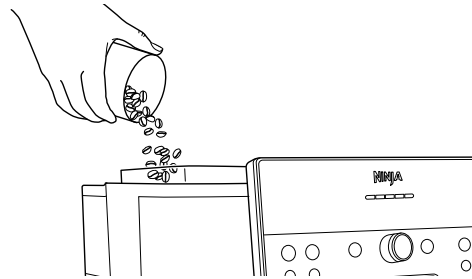

Fill bean hopper with whole beans*. You may fill the hopper as much as you desire. Be sure the bean hopper is secured to the machine before brewing. **DO NOT** add pre-ground beans to bean hopper.

*For more information on beans, see Best Bean Practices.

STEP 4: FLUSH YOUR MACHINE

YOU MUST RUN A WATER FLUSH BEFORE FIRST USE. DO THIS ONLY ONCE.

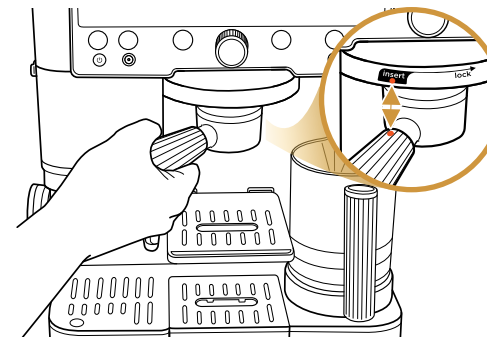

With the double basket installed in the portafilter, place the portafilter in group head (angled to the left) by aligning orange dot on portafilter with orange dot on group head.

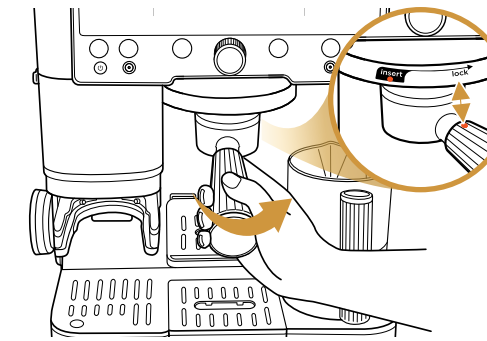

Fasten portafilter into group head until orange dot on portafilter aligns with lock arrow on group head.



Turn the center dial to select **CLASSIC**.



Press the **SIZE** button to adjust drink size to **12 OZ**.

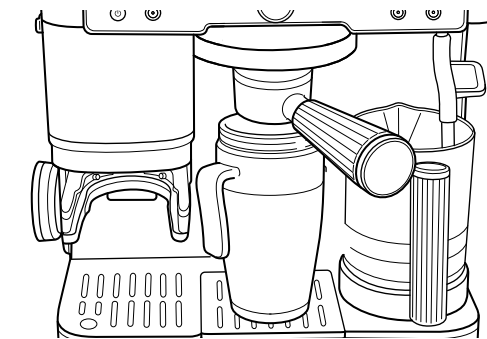

Place a 14 oz. or greater cup under the portafilter.



Press **START BREW**. The machine will beep to signal the brew has started. The progress bar will illuminate, indicating the status of the brew.

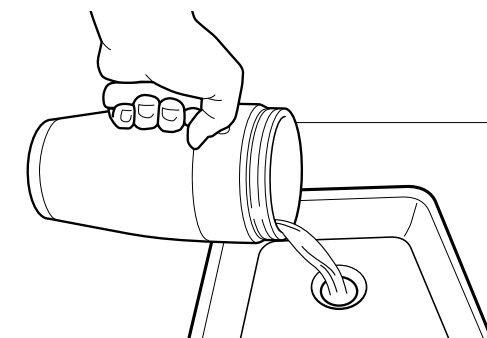

When finished, the machine will beep again, signifying the brew is complete. Discard the water, **then rinse and dry the portafilter**.

DIALING IN YOUR ESPRESSO

"Dialing in" means calibrating the grind size for your beans to get the perfect espresso extraction for your drink.

Barista Assist Technology™ automatically does this for you. All you have to do is run through the steps below twice, and the machine should be calibrated for your current beans.

STEP 1: PREP YOUR DRINK

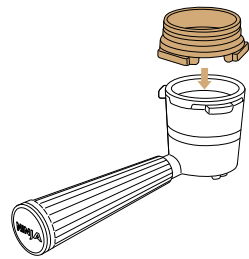

Place funnel on portafilter with double basket*, aligning the notches on the funnel with the notches on the portafilter. Push down until funnel locks into place in the portafilter.

*THE DOUBLE BASKET COMES INSTALLED IN THE PORTAFILTER.

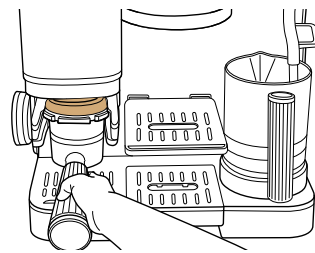

With the funnel on top of the portafilter, insert portafilter in the grinding cradle. Make sure it is level and fits securely. Once portafilter is installed in grinding cradle, it will be weighed. To ensure accurate weight, let go of portafilter.

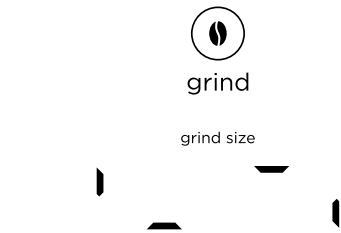

Once portafilter is properly installed, the machine will display an animation and drink options available for that basket.

Note: If you do not see this animation, remove the portafilter from the grinding cradle, power the machine off and on, and reinstall the portafilter in the grinding cradle, ensuring it is level and pushed all the way in.

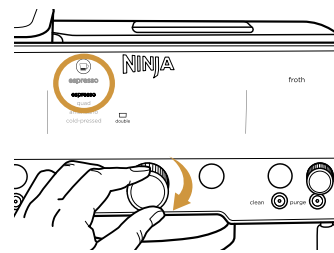

Turn the center dial to select **ESPRESSO**.

STEP 2: GRIND THE BEANS

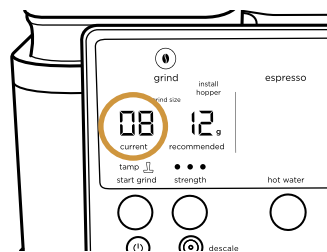

Check to see if the current grind setting matches the recommended setting.

Note: The numbers displayed in the images are for reference only and may not match what is displayed on your machine.

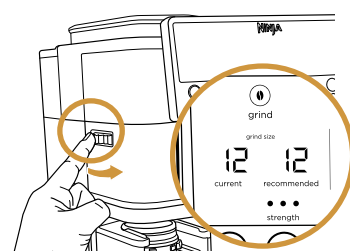

If they don't match, **adjust current grind size by spinning the grind dial on left side of machine** until it matches the recommended setting.

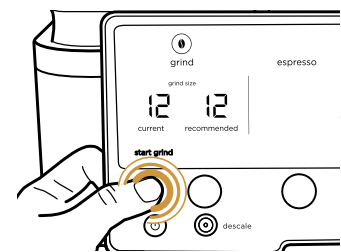

Press **START GRIND**. Do not touch portafilter until grinding is complete.

NOTE: Once a grind is complete, the machine will be set to the brew style and size that was selected for that grind. To change style and size, pour grounds out of portafilter, power the machine off and on, and restart from Step 1, selecting desired style and size before grinding.

STEP 3: BREW ESPRESSO

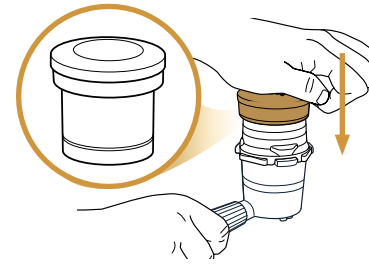

After grinding remove portafilter. On a solid level surface with funnel still attached, **press tamper all the way down until it meets funnel.**

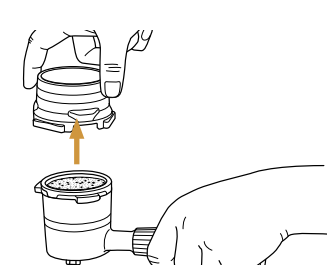

Remove funnel from portafilter. Place funnel and tamper in storage on left side of machine.

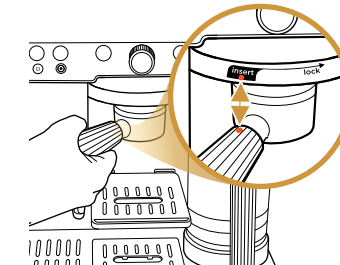

Place portafilter in group head (angled to the left) by aligning orange dot on portafilter with orange dot on group head.

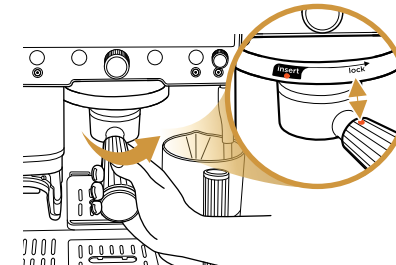

Fasten portafilter into group head until orange dot on portafilter aligns with lock arrow on group head.

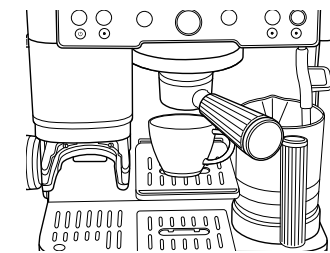

Place a cup under the portafilter.

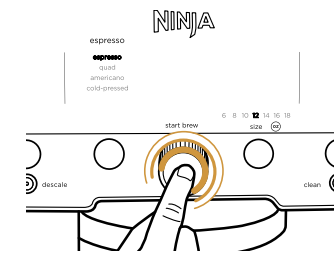

Press **START BREW**. The machine will beep to signal the brew has started. The progress bar will illuminate, indicating the status of the brew.

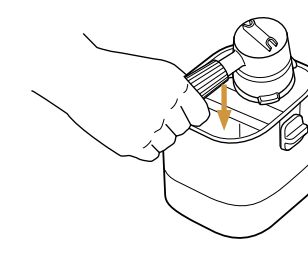

When finished, the machine will beep again to signify the brew is complete. Carefully remove portafilter from group head. Dispose of grounds by tapping the surface of the basket over a container or knock box*.

PLEASE USE CAUTION AS PORTAFILTER WILL BE HOT.

*KNOCK BOX SOLD SEPARATELY AT NINJAKITCHEN.COM/ACCESSORIES

Now that your first brew is complete, discard the drink and repeat steps 1-3. Once your second brew is complete, Barista Assist Technology™ will have dialed in the recommended grind setting to get perfect extraction. The machine is now ready to make espresso. Please note that you will have to do this whenever you are switching the type of beans you are putting in the hopper.

FOR MORE INFORMATION, REFER TO UNDERSTANDING BARISTA ASSIST TECHNOLOGY.

ESPRESSO 101: BREW A LATTE

BEGINNER RECIPE ●○○
MAKES: 1 SERVING (9 ½ OZ.)

INGREDIENTS

Double shot espresso
1 cup (8 ounces) milk



STEP 1: PREP YOUR DRINK

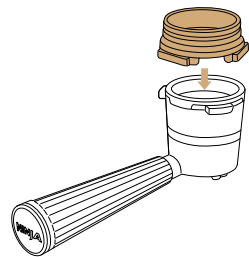

Place funnel on portafilter with double basket*, aligning the notches on the funnel with the notches on the portafilter. Push down until funnel locks into place in the portafilter.

*THE DOUBLE BASKET COMES INSTALLED IN THE PORTAFILTER.

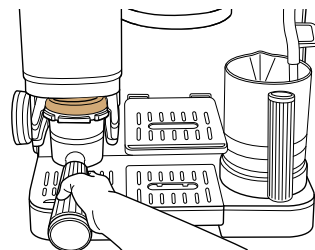

With the funnel on top of the portafilter, insert portafilter in the grinding cradle. Make sure it is level and fits securely. Once portafilter is installed in grinding cradle, it will be weighed. To ensure accurate weight, let go of portafilter.



Once portafilter is properly installed, the machine will display an animation and drink options available for that basket.

Note: If you do not see this animation, remove the portafilter from the grinding cradle, power the machine off and on, and reinstall the portafilter in the grinding cradle, ensuring it is level and pushed all the way in.

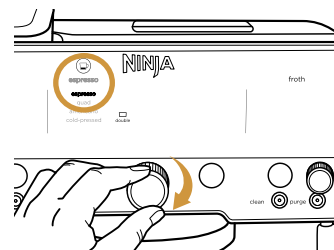

Turn the center dial to select **ESPRESSO**.

STEP 2: GRIND THE BEANS

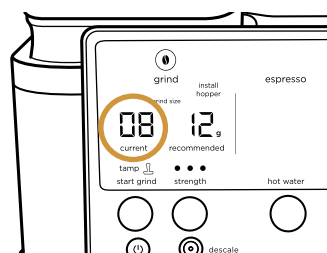

Check to see if the current grind setting matches the recommended setting.

Note: The numbers displayed in the images are for reference only and may not match what is displayed on your machine.

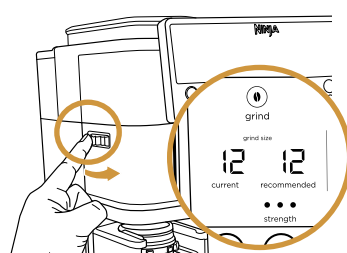

If they don't match, **adjust current grind size by spinning the grind dial on left side of machine** until it matches the recommended setting.

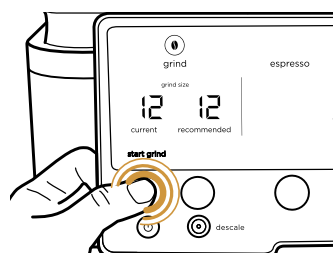

Press **START GRIND**. Do not touch portafilter until grinding is completed.

Note: Before you grind, make sure the funnel is installed to prevent overflow.

NOTE: Once a grind is complete, the machine will be set to the brew style and size that was selected for that grind. To change style and size, pour grounds out of portafilter, power off and on the machine, and restart from Step 1 selecting desired style and size before grinding.

STEP 3: BREW ESPRESSO

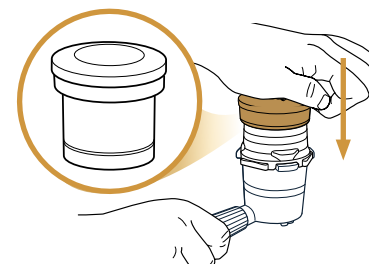

After grinding, remove portafilter. On a solid level surface with funnel still attached, **press tamper all the way down until it meets funnel.**

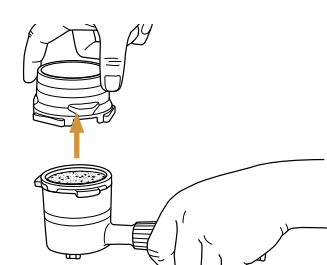

Remove funnel from portafilter. Place funnel and tamper in storage on left side of machine.

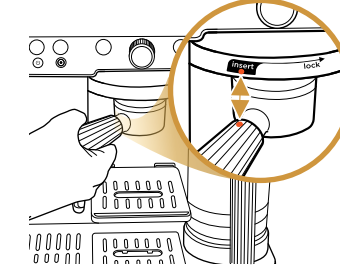

Place portafilter in group head (angled to the left) by aligning orange dot on portafilter with orange dot on group head.

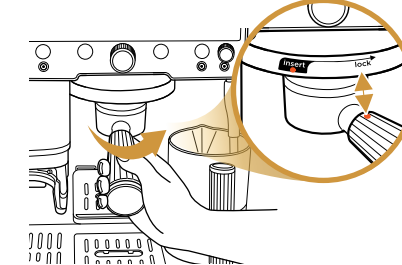

Fasten portafilter into group head until orange dot on portafilter aligns with lock arrow on group head.

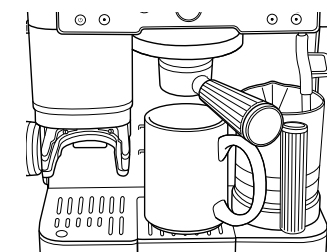

Place a cup under the portafilter.



Press **START BREW**. The machine will beep to signal the brew has started. The progress bar will illuminate, indicating the status of the brew.

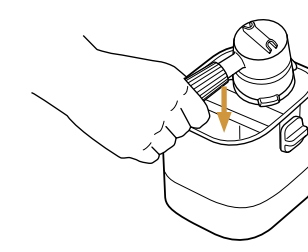

When finished, the machine will beep again to signify the brew is complete. Carefully remove portafilter from group head. Dispose of grounds by tapping the surface of the basket over a container or knock box*.

NOTE: If you would like to adjust your drink settings, or are not satisfied with the results, please refer to Understanding Barista Assist Technology™ and Adjusting Your Drink Preferences.

PLEASE USE CAUTION AS PORTAFILTER WILL BE HOT.

*KNOCK BOX SOLD SEPARATELY AT NINJAKITCHEN.COM/ACCESSORIES

STEP 4: FROTH DAIRY OR PLANT-BASED MILK

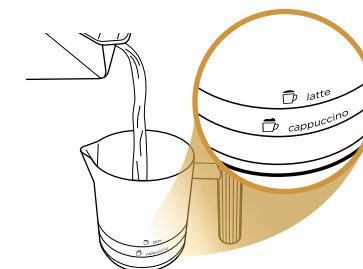

Fill the milk jug to the line labeled **LATTE** with dairy or plant-based milk.

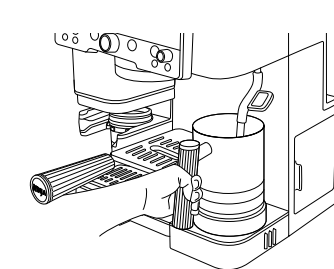

Place milk jug on milk jug platform with steam wand inside.



Press **MILK TYPE** button based on the milk in the jug.

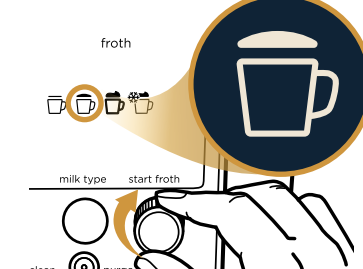

Turn froth dial to **THIN**.

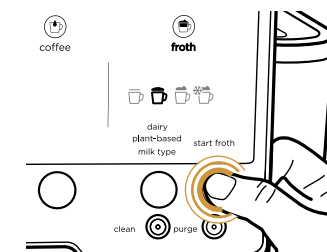

Press **START FROTH** to begin frothing. The machine will beep to signal the froth has started. The progress bar will illuminate, indicating the status of the froth.

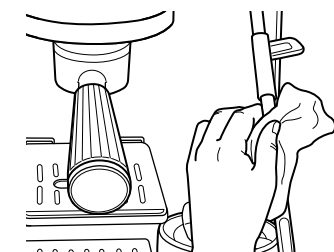

When finished, the machine will beep again to signify the froth is complete. Remove jug and **immediately wipe steam wand with a damp cloth.**

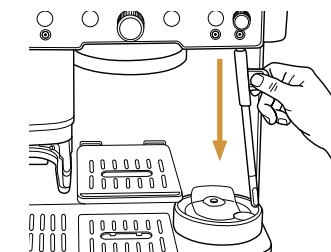

Push steam wand into its down position. The machine will automatically purge to clean inside of wand.

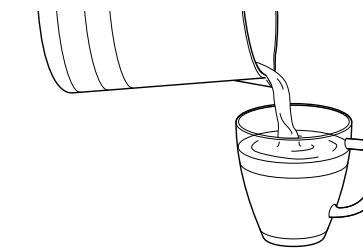

Before pouring milk, tap the jug on a flat surface and swirl around to remove large bubbles. Pour frothed milk over espresso and enjoy.

PLEASE USE CAUTION, AS STEAM WAND WILL BE HOT.

CONGRATULATIONS, YOU'VE MADE A LATTE! KEEP READING FOR MORE INFORMATION ON HOW THE MACHINE WORKS, TIPS & TRICKS, AND CLEANING & MAINTENANCE.

UNDERSTANDING BARISTA ASSIST TECHNOLOGY™

You may notice your recommended grind setting change. This is Barista Assist Technology adjusting the recommended grind setting to help you get proper espresso extraction. When adding more beans, it may take 2-3 brews to reach the optimal grind setting. Over time, you may notice your recommended grind setting change to account for aging beans. This is normal. Ensure your current grind size matches the recommended grind size for proper espresso extraction.

An accurate dose of coffee grounds is also important for proper espresso extraction. Barista Assist Technology features a built-in scale that will grind until you have the proper dose of coffee grounds in your portafilter. Once the portafilter is installed in the grinding cradle, immediately let go to allow it to properly weigh and dose the coffee grounds.



THIS IS WHAT PROPER ESPRESSO EXTRACTION LOOKS LIKE

- Espresso will pour out at a slow, consistent rate.
- You will see a caramel-colored liquid pouring out. That is your crema.
- There will be a layer of crema on top of your drink. Feel free to tilt your cup to see if the layer of crema is still completely visible. If you can still only see that caramel color, you have a properly extracted espresso shot.

Note that grind recommendation will only adjust over time for espresso brews. For coffee brews, grind recommendations will stay the same.

TIPS & TRICKS

BEST BEAN PRACTICES

For best results, use freshly roasted coffee beans.

When purchasing coffee beans, it's best to buy a bag with a "Roasted On" date rather than a "Best Before" date to ensure quality and freshness.

We recommend you use any coffee beans within 20 days of the "Roasted On" date.

ADJUSTING BREW STRENGTH AND TEMPERATURE

CHANGING BREW STRENGTH

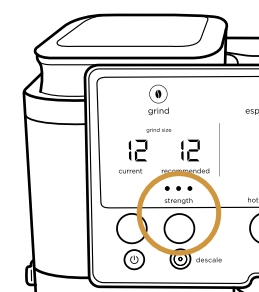

Adjusting Brew Strength:
To adjust brew strength, press the STRENGTH button.

Espresso Strength Options:

- ○ ○ Taller, less concentrated: 4:1 water to grounds ratio
- ● ○ Default: 2.5:1 water to grounds ratio
- ● ● Shorter, more concentrated: 2:1 water to grounds ratio

Coffee Strength Options:

- ○ ○ Mild: Less grounds will be dosed
- ● ○ Default
- ● ● Bold: More grounds will be dosed

CHOOSING THE RIGHT CUP

Ensure the cup you are using is appropriate for the size of your drink. For a hotter drink, use a cup that is a similar size to your drink.

The thickness of the material your cup is made of will also affect the temperature of your drink. For a hotter drink, use a cup made of thinner material.

PREHEATING BEFORE YOU BREW

Running hot water through the group head and portafilter will help preheat them and the machine for future brews. To further increase the temperature of your drink, run a water-only double shot of espresso through the portafilter into the cup you would like to have your drink in. The temperature of your cup will impact the temperature of your drink. Discard the water, then dry the cup and portafilter. Then, proceed to brewing. See Water Flush for instructions.

BREW TEMP ADJUSTMENT

- 1 Hold the SIZE button for 3 seconds.
- 2 Rotate the center dial to _h06, then press the center dial to select.
- 3 Rotate the center dial to select your desired setting, then press the center dial to select.

LO: Low temperature

M: Medium temperature

HI: High temperature

To leave the additional settings menu, press the SIZE button.

The temperature setting will affect the extraction of espresso and the flavor of your drink. For best results and proper extraction, we recommend a low or medium temperature for darker roasts, and a medium or high temperature for lighter roasts.

MILK TEMPERATURE ADJUSTMENT

Adjust milk temperature in the additional settings.

- 1 Hold the SIZE button for 3 seconds.
- 2 Rotate the center dial to _h07, then press the center dial to select.
- 3 Rotate the center dial to select your desired temperature, then press the center dial to select.

Low: Select this setting if your froth is coming out too hot or if you would like your froth to be slightly thinner.

Medium: Our barista-recommended default setting.

High: Select this setting if your froth is coming out too cold or if you would like your froth slightly thicker.

To leave the additional settings menu, press the SIZE button.

CLEANING & MAINTENANCE

DAY-TO-DAY MAINTENANCE

CLEANING THE BASKETS AND PORTAFILTER

Remember to clean these after each brew. Remove the basket from the portafilter and hand-wash both thoroughly.

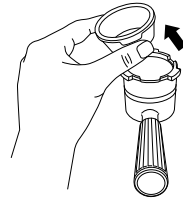

EMPTYING DRIP TRAY

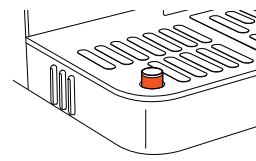

When the orange empty indicator rises enough to be visible, it's time to empty the main drip tray.

CLEANING THE FROTHER

Wipe with damp cloth: Do this immediately after frothing to prevent any milk from getting stuck to the steam wand.

Auto purge: After every froth, push the steam wand back into the down position without the jug installed to initiate an auto purge. This will help clean the inside of the steam wand after frothing. You can purge any time by pressing the PURGE button.

Removable whisk: Remove the whisk from the milk jug and hand-wash thoroughly after each use.

For a deeper clean of the whisk and steam wand, fill milk jug with water and a drop of dish soap and run the THIN ☞ froth program.

DISHWASHER-SAFE PARTS

Funnel, whisk, cleaning disc, water reservoir, bean hopper, and all drip tray components.

CLEANING & MAINTENANCE

PERIODIC MAINTENANCE

The following are instructions for the descale and cleaning cycles. These are separate procedures and should be done whenever the corresponding light is illuminated on the control panel.

DESCALING

Time to complete: approximately 90 minutes

When the descale light illuminates, you must run a descale cycle. If a descale isn't performed after the light turns on, drink quality will diminish and your machine may clog and stop working.

Descaling breaks down and removes limescale and mineral buildup inside the machine. Doing this will help maintain peak performance if routinely performed with a descale solution whenever the DESCALE light turns on.

- 1 Ensure the main drip tray is completely emptied, as some of the water brewed from the descale cycle will be deposited into the drip tray. **Not emptying the main drip tray may cause overflow.**

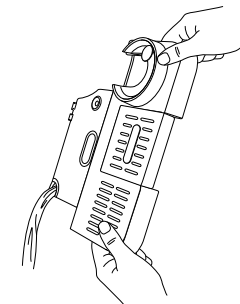

- 2 Dissolve the provided Ninja descale powder in a separate container with 37 fl. oz. of water. Pour solution mixture into water reservoir.

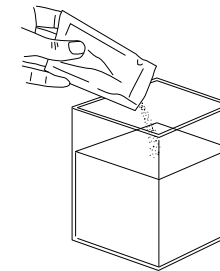

OR

- Fill the water reservoir with 16 oz. of white vinegar, then fill the reservoir to the Descale line with water.
- 3 Insert the double basket into the portafilter.
- 4 Fasten the portafilter into the group head.
- 5 Ensure milk jug is placed on the milk jug platform with the steam wand inside.
- 6 Place an empty cup (at least 18 oz.) under the portafilter. You may have to remove the center drip tray.
- 7 Press the DESCALE button, then press the center dial to start the descale cycle.
- 8 The machine will start the descale cycle. The machine will flush solution through the steam wand and portafilter for approximately 90 minutes. The machine will count down the remaining time on the control panel.
- 9 The machine will beep indicating when the descale cycle is complete.
- 10 After the cycle is complete, remove the portafilter, main drip tray, and milk jug with caution, as there will be water in each.
- 11 Empty the contents of each and hand-wash with warm, soapy water to remove any solution that could affect the flavor of your coffee.
- 12 Fill the reservoir with fresh water up to, but not exceeding, the Max Fill line.
- 13 Install the main drip tray back on the machine and install the portafilter in the group head. Do not install the milk jug.
- 14 Flush the group head by running a 12 oz. classic brew.
- 15 Then, with the milk jug uninstalled, flush the steam wand by pressing the PURGE button.

RUNNING A CLEAN CYCLE

Time to complete: approximately 6 minutes

A clean cycle flushes out residual oils or grounds that are built up in and around the group head. The CLEAN light will automatically illuminate to indicate when a clean cycle is required. You may also run a clean cycle if you notice a change in brew quality. The clean cycle requires the cleaning disc (included with the machine and storable in the accessory storage) and a cleaning tablet (also included and available for purchase on ninjakitchen.com/accessories).

Follow these steps to run a clean cycle:

- 1 Ensure the main drip tray is completely empty as the water brewed from the clean cycle will be deposited into the main drip tray. **Not emptying the main drip tray may cause overflow.**

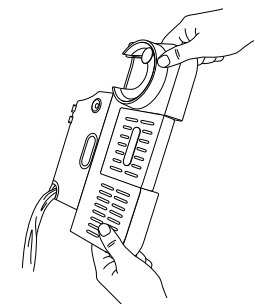

- 2 Fill the water reservoir up to but not exceeding the Max Fill line.
- 3 Insert the double basket in the portafilter.
- 4 Place the cleaning disc on top of the double basket, with the handle facing up.

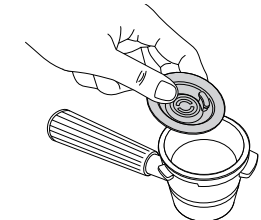

- 5 Place 1 cleaning tablet in the center of the cleaning disc.

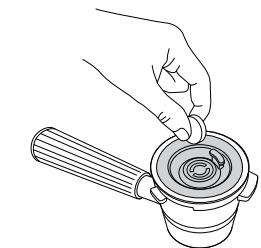

- 6 Fasten the portafilter in the group head.
- 7 Press the CLEAN button, then press the center dial to start the clean cycle.
- 8 The machine will start the process of backflushing the shower screen and group head and depositing the water and sediment from the clean cycle into the main drip tray.
- 9 The clean cycle will take approximately 6 minutes to complete. The machine will beep when the clean cycle is complete.
- 10 After the clean cycle is complete, remove both the portafilter and main drip tray with caution, as there may be water in both. Hand-wash with warm soapy water.

NINJA LUXE CAFÉ

For more recipes, visit ninjakitchen.com/recipes
For accessories and replacement parts, visit ninjaaccessories.com

BARISTA ASSIST TECHNOLOGY and NINJA LUXE are trademarks of SharkNinja Operating LLC.

© 2024 SharkNinja Operating LLC

ES601_QSG_REV_Mv11