

THANK YOU
for purchasing the Ninja® Luxe Café



REGISTER YOUR PURCHASE

- registryourninja.com
- 1-877-646-5288
- Scan QR code using mobile device

RECORD THIS INFORMATION

Model Number: _____
Serial Number: _____
Date of Purchase: _____
(Keep receipt)
Store of Purchase: _____

TECHNICAL SPECIFICATIONS

Voltage: 120V~, 60Hz
Power: 1650W
Water Reservoir
Capacity: 70 oz.

TIP: You can find the model and serial numbers on the QR code label located on the back of the machine by the power cord.

PLEASE READ CAREFULLY AND KEEP FOR FUTURE REFERENCE.

These instructions are designed to help you get a complete understanding of your new Ninja Luxe Café. If you have any questions, please call our Customer Service line at 1-877-646-5288.

SharkNinja Operating LLC
US: Needham, MA 02494
1-877-646-5288
ninjakitchen.com

Illustrations may differ from actual product. We are constantly striving to improve our products, therefore the specifications contained herein are subject to change without notice.

NINJA LUXE is a trademark of SharkNinja Operating LLC.

This product may be covered by one or more U.S. patents. See sharkninja.com/patents for more information.

© 2024 SharkNinja Operating LLC

ES601_IB_REV_Mv10



NINJA LUXE CAFÉ



ES600 Series | Owner's Guide

IMPORTANT SAFETY INSTRUCTIONS

PLEASE READ CAREFULLY BEFORE USE • FOR HOUSEHOLD USE ONLY

	Read all instructions before using your Ninja Luxe Café
	Indicates the presence of a hazard that can cause personal injury, death or substantial property damage if the warning included with this symbol is ignored.
	Avoid contact with hot surface. Always use hand protection to avoid burns.
	For indoor and household use only.

WARNING

To reduce the risk of injury, fire, electrical shock or property damage, basic safety precautions must always be followed, including the following numbered warnings and subsequent instructions. Do not use machine for other than intended use.

General Precautions

- To eliminate a choking hazard for young children, discard all packaging materials immediately upon unpacking.
- This machine can be used by persons with reduced physical, sensory, or mental capabilities or lack of experience and knowledge if they have been given supervision or instruction concerning use of the machine in a safe way and understand the hazards involved.
- Keep the machine and its cord out of reach of children. **DO NOT** allow the machine to be played with or be used by children. Close supervision is necessary when used near children.
- To protect against fire, electric shock, and injury to persons, **DO NOT** immerse cord, plugs, or body of machine in water or other liquid.
- NEVER** carry the machine by the power cord or pull it to disconnect from electrical socket; instead grasp the plug and pull to disconnect.
- DO NOT** operate any machine with a damaged cord or plug, or after the machine malfunctions or has been dropped or damaged in any manner. Contact SharkNinja Operating LLC for service.
- For household and countertop use only. **DO NOT** let the power cord hang over the edge or touch hot surfaces such as a stove.
- NEVER** use an electrical socket below a counter.
- To avoid risk of fire, electrical shock, or damage to the machine, **DO NOT** use machine in an machine garage or under a wall cabinet.
- Unplug from outlet when the machine is not in use and before cleaning.
- NEVER** leave an machine unattended while in use.
- Machine is not intended to be operated by means of an external timer or separate remote-control system.
- DO NOT** place on top of any other machine.
- The machine shall not be placed in a cabinet when in use.
- DO NOT** use any accessory not recommended by the manufacturer, as this may result in injury or damage to the machine.

READ AND SAVE THESE INSTRUCTIONS

IMPORTANT SAFETY INSTRUCTIONS

PLEASE READ CAREFULLY BEFORE USE • FOR HOUSEHOLD USE ONLY

⚠ WARNING

To reduce the risk of injury, fire, electrical shock or property damage, basic safety precautions must always be followed, including the following numbered warnings and subsequent instructions. Do not use machine for other than intended use.

Operating Notice

- Power the machine off and unplug from the wall outlet.
- The use of an accessory not recommended by the manufacturer may create an overflow condition and scalding hazard, or result in fire, electric shock, or personal injury.
- **ALWAYS** use machine on a clean, dry, level surface.
- **DO NOT** place on or near a hot gas or electric burner or in a heated oven.
- **DO NOT** use this machine for anything other than its intended use.
- **DO NOT** use outdoors.
- **DO NOT** touch hot surfaces. Use handles or knobs. Avoid contacting moving parts.
- **ALWAYS** place a cup or vessel appropriate for output volume selection beneath the portafilter when brewing.
- **DO NOT** run the machine without water.
- **DO NOT** overfill the water reservoir. Fill water only to the maximum fill line.
- Keep lid on water reservoir when brewing.
- Keep bean hopper lid on when grinding to prevent access to moving parts.
- **DO NOT** remove portafilter when brewing as machine is under pressure. Removal while brewing can lead to scalding or injury.
- **DO NOT** reach in or touch steam wand or frother jug when in operation. Hot steam and hot liquids will cause burns and scalds.

Care & Maintenance

- To prevent illness from bacterial growth in the machine, follow all cleaning instructions in the Cleaning & Maintenance section of this Owner's Guide.
- For best results, ensure you are using a clean machine.
- If the product is not operating properly, visit ninjakitchen.com or contact SharkNinja Operating LLC for examination, repair, or adjustment.
- Children shall not engage with cleaning and maintenance activities.
- When portafilter is in use, ensure it is tightened in the group head to prevent spillover of hot liquid.
- **DO NOT** pick up the machine by the grinding cradle. This apparatus is not meant to hold weight of product.

Cord Statement

- A short power-supply cord is provided to reduce the risks resulting from becoming entangled in or tripping over a longer cord.
- **DO NOT** use extension cords with this product.

READ AND SAVE THESE INSTRUCTIONS

ASSEMBLY

Scan for easy 3D instructions

Tap. Zoom. Rotate with official interactive instructions on the BILT app.



BILT.®

Download on the App Store

GET IT ON Google Play

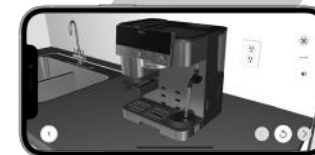

PARTS

- A Bean Hopper
- B Water Reservoir
- C Cup Warmer
- D Control Panel
- E Accessory Storage
- F Steam Wand
- G Group Head
- H Milk Jug with Integrated Whisk
- I Adjustable Cup Tray
- J Grinding Cradle
- K Main Drip Tray
- L Assisted Tamper Storage
- M Funnel Storage
- N Grind Dial
- O Integrated Conical Burr Grinder

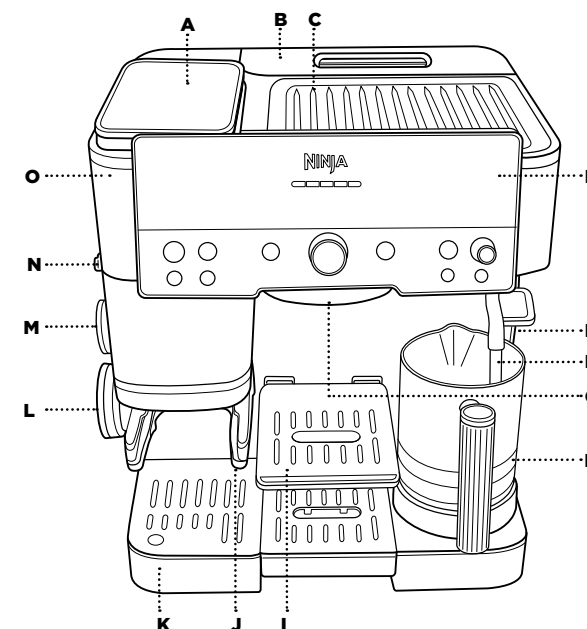

DRIP TRAY COMPONENTS

- K Main Drip Tray
- K1 Empty Indicator
- K2 Main Grate
- K3 Center Drip Tray
- K4 Center Grate
- K5 Milk Jug Platform

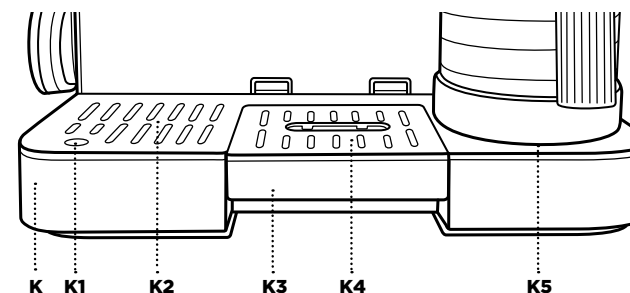

ACCESSORIES

- 1 Single Basket *
(not available on all machines)
- 2 Double Basket
- 3 Luxe Basket
- 4 Portafilter
- 5 Cleaning Disc
- 6 Cleaning Brush
- 7 Funnel
- 8 Assisted Tamber
- 9 Cleaning Tablets
- 10 Descale Powder
- 11 Water Hardness Test Strip

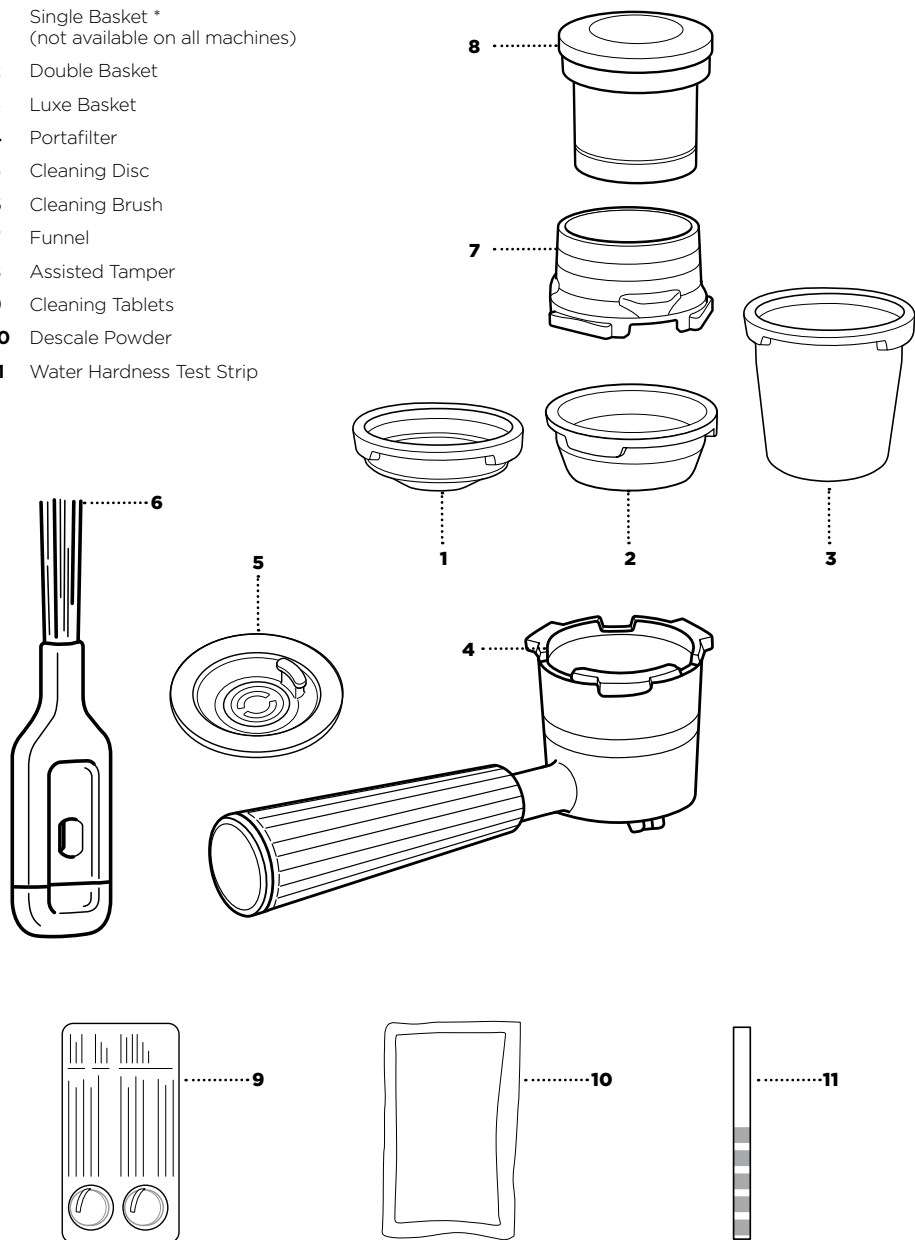

*Single basket not compatible with all models.

USING THE CONTROL PANEL*

- | | |
|--|--|
| A POWER Button | G MILK TYPE Button |
| B START GRIND Button | H SIZE Selection Button |
| C Progress Bar | I Center Dial/START BREW Button |
| D Froth Dial/START FROTH Button | J STRENGTH Button |
| E PURGE Button | K DESCALE Button |
| F CLEAN Button | |

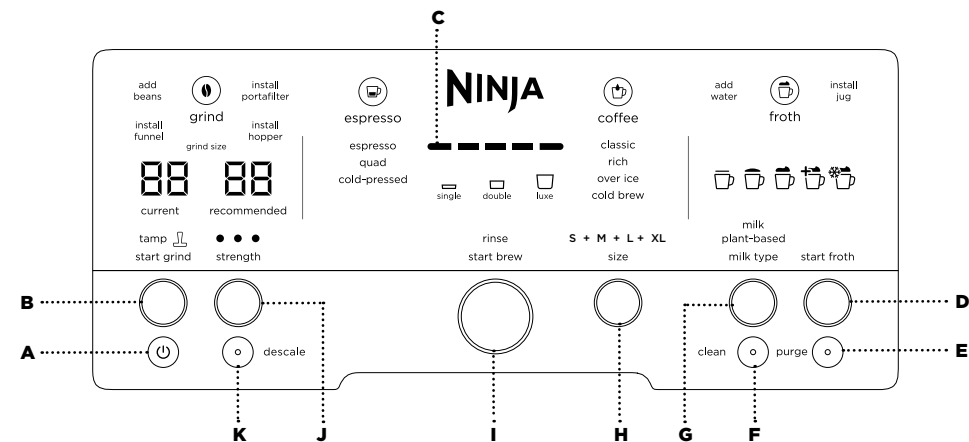

*Functions may vary by model.

INTELLIGENT NOTIFICATIONS

The machine will display an intelligent notification if an action is needed:

- ADD BEANS
- INSTALL PORTAFILTER
- INSTALL FUNNEL
- INSTALL HOPPER
- ADD WATER
- INSTALL JUG
- RINSE
- PURGE
- DESCALE*
- CLEAN*

*The CLEAN and DESCALE buttons will illuminate to let you know you need to run the respective cycle.

GETTING STARTED: BEFORE YOUR FIRST BREW

REMOVE ACCESSORIES & PARTS FROM PACKAGING

- To start, remove all accessories and parts from packaging. Ensure that all accessories and parts are removed from the packaging before discarding packaging.
- When removing the machine from packaging, be sure to remove all tape from machine. Tape will be on all sides of the machine.

CLEAN ACCESSORIES BEFORE USE

- After removing all accessories and parts from the packaging, thoroughly clean all parts by hand-washing and dry thoroughly.

WATER HARDNESS TEST

All water has minerals that can cause buildup in the machine over time. These minerals are referred to as water hardness, and will impact how often you will need to descale the machine. Doing this test will ensure the machine recommends a descale at the right time.

- 1 Remove test strip from pack.

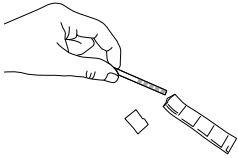

- 2 Completely submerge the water test strip in the water you plan on using with the machine for 5-10 seconds.



- 3 Pull test strip out and lightly shake it.

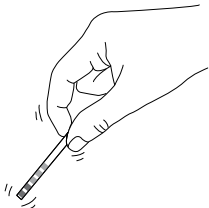

- 4 Place test strip on a dry, flat surface and wait 1 minute for test strip to display results.
- 5 After 1 minute, you will see 0-5 purple squares appear. This will indicate the water hardness level of the water (0 purple squares=level 0, 5 purple squares=level 5, etc.)

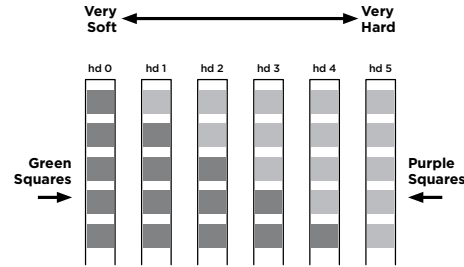

- 6 After identifying the water hardness level, plug in the machine and turn it on by pressing the POWER button.
- 7 Look at the left side of the control panel. It will display hd 5.
- 8 Rotate the center dial to program the water hardness level by matching the number of purple squares on the test strip to the number displayed. (e.g., if the result is level 1, change the setting to hd 1).

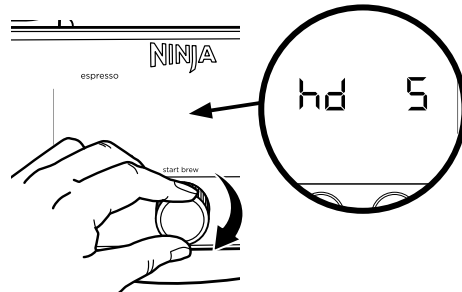

- 9 Press center dial to confirm your setting.

NOTE: If you need to change the hardness level, purchase another test strip at ninjakitchen.com/accessories. For more instructions on how to reset the water hardness, refer to the Additional Settings section.

FILL THE WATER RESERVOIR

- Before you begin, make sure the water reservoir is full of room-temperature or cold water. Be sure to fill up to but not exceeding the maximum fill line.

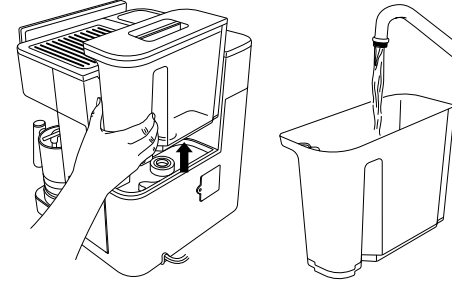

If at any point before a brew there's not enough water in the reservoir to brew your selected drink, the machine will indicate that you must ADD WATER. If you get an ADD WATER notification while brewing, add water to the reservoir and press START BREW to resume.

FILL THE BEAN HOPPER

When adding beans to the hopper, be sure the machine is unplugged.

- 1 Remove the lid of the hopper, fill hopper with beans, then place the lid securely back on the hopper. Ensure the handle in the hopper is in the locked position when installed on the hopper.

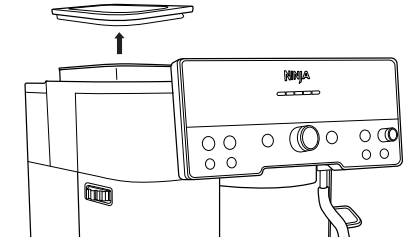

- 2 Fill hopper with whole beans. **DO NOT** add pre-ground beans to bean hopper.

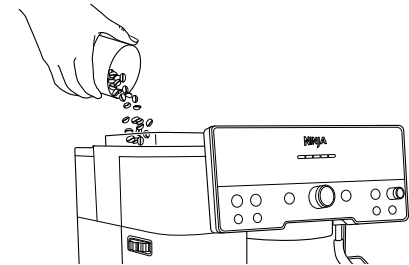

- 3 Ensure the handle in the hopper is in the locked position when installed on the hopper, then place lid securely back on the hopper.

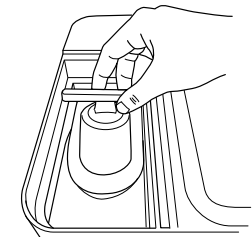

NOTE: DO NOT put any water in the grinder. If water does get in the grinder, please call us at 1-877-646-5288 immediately.

GETTING STARTED: BEFORE YOUR FIRST BREW CONT.

WATER FLUSH

Before you make your first drink, you must flush the machine. This is to condition the machine to prepare for brewing.

- 1 With the double basket installed, place portafilter in group head by aligning orange dot on portafilter with orange dot on group head.

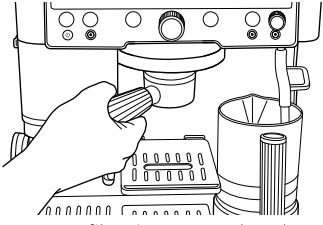

- 2 Fasten portafilter into group head until orange dot on portafilter aligns with lock arrow on group head.

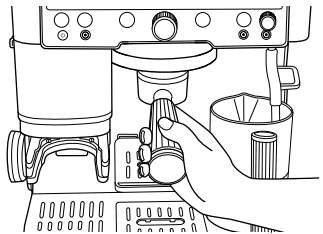

- 3 Turn the center dial to select CLASSIC.

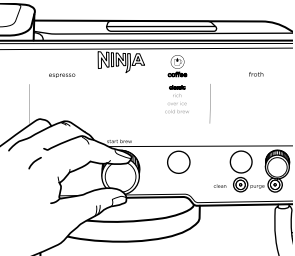

- 4 Press the SIZE button to adjust drink size to 12 oz. Ensure you have at least 14 oz. of water in the reservoir.

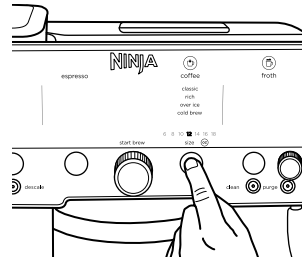

- 5 Place 14 oz. or greater cup underneath the portafilter.



- 6 Press START BREW. The machine will beep to signal the brew has started. The progress bar will illuminate to indicate the status of the brew. When finished, the machine will beep again.
- 7 Dispose the water you brewed and wash the cup.

BREWING ESPRESSO, DRIP COFFEE, AND COLD DRINKS

ESPRESSO/COFFEE BASKETS

- 1 The Starter Kit contains the baskets. There are three baskets (single, double, and luxe baskets may vary per model).



Single*
Espresso,
Cold-Pressed



Double
Espresso,
Cold-Pressed



Luxe
Quad,
Cold-Pressed,
all coffee-based
drinks

*Single basket not compatible with all models.

- 2 Choose a basket based on what drink you would like, then insert into the portafilter. Ensure that the large tab on the basket aligns with the large tab on the portafilter, and then press firmly into place.

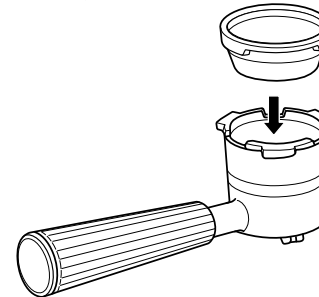

NOTE: Double basket comes pre-installed in portafilter.

PORTAFILTER INSTALLATION

- 1 Place funnel on portafilter, aligning the notches on the funnel with the notches on the portafilter. Push down until funnel locks into place in the portafilter. The funnel prevents grounds from overflowing during grinding and allows for a cleaner tamping process.

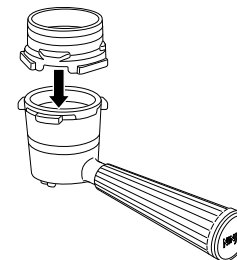

- 2 With the funnel on top of the portafilter, insert into the grinding cradle. Make sure it is level and fits securely. Once portafilter is installed in grinding cradle, it will be weighed. To ensure accurate weight, let go of portafilter.

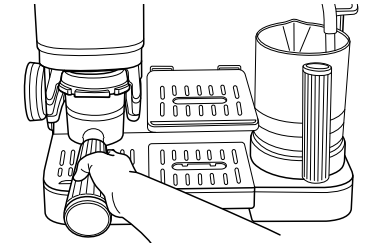

- 3 The machine will detect which basket is locked into it. The machine will display an animation. This is to indicate the machine is taring the portafilter to ensure it is dispensing the right amount of grounds. Then the control panel will illuminate the selectable brew options based on the basket that is installed.



grind size

NOTE: If you do not see this animation, remove the portafilter from the grinding cradle, power the machine off and on, and reinstall the portafilter in the grinding cradle, ensuring it is level and pushed all the way in.

- 4 Turn the center dial to your desired brew.

BREWING ESPRESSO, DRIP COFFEE, AND COLD DRINKS CONT.

APPROXIMATE BREW VOLUMES

COFFEE VOLUMES		
	Classic Rich	Over Ice Cold Brew (Must Fill with Ice Before Brewing)
SIZES	6 oz.	6 oz.
	8 oz.	8 oz.
	10 oz.	10 oz.
	12 oz.	12 oz.
	14 oz.	14 oz.
	16 oz.	16 oz.
	18 oz.	18 oz.

ESPRESSO VOLUMES		
	Grounds Dose	Output Volume
Single Espresso	9 g	0.8 oz.
Double Espresso	18 g	1.6 oz.
Double Cold-Pressed	18 g	1.6 oz.
Quad Espresso	40 g	3.5 oz.
Quad Cold-Pressed	40 g	3.5 oz.

NOTE: These are the preset espresso outputs. To adjust output, please refer to the Additional Settings section.

USING THE GRINDER

- Once a brew is highlighted, Barista Assist Technology™ will recommend a grind size based on the beans and previous brew output. If you wish to follow the recommended size, use the grind dial on the side of the machine to change the **CURRENT** grind size to match the **RECOMMENDED** grind size.

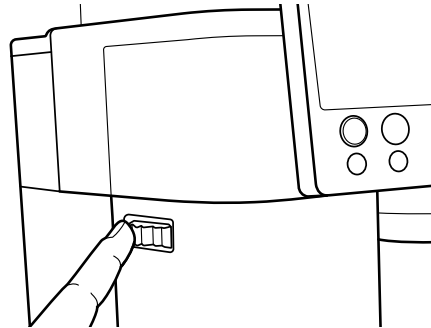

- Once you have selected your desired grind setting, press START GRIND to begin grinding. The machine will beep to indicate that grinding has started. When finished, the machine will beep again signifying grinding is complete. The control panel will flash TAMP, signifying that you must tamp the grounds.

NOTE: Once a grind is complete, the machine will be set to the brew style and size that was selected for that grind. To change style and size, pour grounds out of portafilter, power the machine off and on, and select your desired brew.

UNDERSTANDING THE GRIND SETTINGS

What do the grind settings mean?

- The numbers on the left side of the control panel represent how coarse or fine the grind will be, with 25 being the coarsest and 1 being the finest. Coarser settings will work better for coffee drinks, and finer settings will work better for espresso drinks.
- Matching the recommended setting: this will bring the best flavors out of your chosen beans. The machine will adjust based on what beans you're using to ensure you are not over extracting or under extracting.

DIALING IN THE GRINDER FOR PROPER EXTRACTION

For espresso brews only

You may notice the recommended grind setting change. This is Barista Assist Technology adjusting the recommended grind setting to help you get proper espresso extraction. When using new beans for the first time or adding more beans, it may take 2-3 brews to reach the optimal grind setting. Over time, you may notice the recommended grind setting change to account for aging beans. This is normal. Ensure the current grind size matches the recommended grind size for proper espresso extraction.

NOTE: When changing from very coarse to very fine (or vice versa), you may hear the grinder turn on. This is to help prevent jamming in the grinder. This will only happen when the portafilter is installed in the grinding cradle.

TAMPING

Be sure to tamp on all espresso drinks, as well as 16 oz. and 18 oz. coffee drinks; this is to ensure no grounds spill over the edge of the portafilter. For 6 oz. to 14 oz. coffee drinks, lightly shake the portafilter to level coffee grounds and then proceed to brewing.



- When grinding is complete remove the portafilter from the grinding cradle. Keep the funnel attached to the portafilter.
- Place the portafilter on a solid, level surface, then place the assisted tamper inside the funnel. Ensure there is protection between the portafilter and surface. Press tamper all the way down until it meets the funnel.

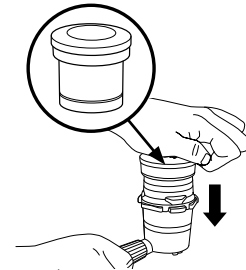

NOTE: When brewing a quad shot, tamp the grounds normally with the funnel on the portafilter. After that, remove the funnel and tamp down the grounds one more time.

- Now that tamping is complete, remove both the tamper and funnel from the portafilter and store in their respective locations on the left side of the machine.

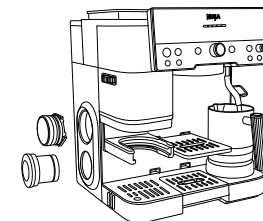

BREWING ESPRESSO, DRIP COFFEE, AND COLD DRINKS CONT.

BREWING

- 1 Place portafilter in group head by aligning orange dot on portafilter with orange dot on group head.
- 2 Fasten portafilter into group head until orange dot on portafilter aligns with lock arrow on group head.

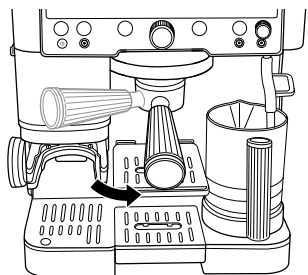

ADJUSTING BREW TEMPERATURE.

Before brewing you can adjust the brew temperature.

- 1 Hold the SIZE button for 3 seconds.
- 2 Rotate the center dial to _h06, then press the center dial to select.
- 3 Rotate the center dial to select your desired setting, then press the center dial to select.

LO: Low temperature

M: Medium temperature (default)

HI: High temperature.

The temperature of the drink will affect the extraction of the espresso and the flavor of your drink. For best results and proper extraction, we recommend a low or medium temperature for darker roasts, and a medium or high temperature for lighter roasts.

NOTE: Temperature control not available for over ice, cold brew, and cold-pressed.

NOTE: DO NOT brew without the main drip tray inserted.

- 3 The brew style and size that was ground will still be selected on the control panel. Place a cup under the portafilter and press START BREW.
- 4 The machine will beep to indicate that the brew has started. The progress bar will illuminate indicating the status of the brew. When finished, the machine will beep again signifying the brew is complete.

NOTE: If you are using a smaller cup, use the adjustable cup tray to lift your cup closer to the group head to reduce splatter. If you are using a larger mug or travel mug, remove the center drip tray to create space.

NOTE: For quad espresso shots and quad cold-pressed shots, there may be some water on the puck after brewing. This is normal.

PROPER EXTRACTION

- Drink will pour out at a slow, consistent rate.
- You will see a caramel-colored liquid pouring out. That is the crema.
- There will be a layer of crema on top of your drink. Feel free to tilt your cup to see if the layer of crema is still completely visible. If you can still only see that caramel color, you have a properly extracted espresso shot.

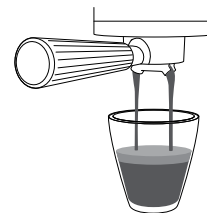

AFTER YOUR BREW

- 1 When brew is complete, carefully remove portafilter from group head. Dispose of grounds by tapping the surface of the basket over a container or knock box (sold separately).

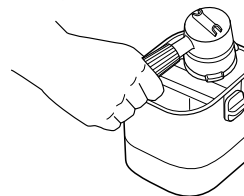

RINSE NOTIFICATION

If you attempt to make a cold drink immediately after making a hot drink, you will get a RINSE notification above the center dial.

Be sure that the portafilter is not installed in the group head before proceeding.

- 1 Put a cup (that can hold at least 12 oz.) below the group head.
- 2 Press START BREW and allow the machine to rinse and get to the right temperature.
- 3 The machine will rinse approximately 8 oz. of water through the group head.
- 4 The machine will beep to indicate that the brew has started. The progress bar will illuminate indicating the status of the brew. When finished, the machine will beep again signifying the brew is complete. After the machine beeps a second time, remove the cup and dispose of the water.

To avoid the RINSE process, brew all desired cold drinks before proceeding to hot drinks.

ADJUSTING YOUR BREW TEMP AND STRENGTH

ADJUSTING BREW TEMPERATURE.

- 1 Hold the SIZE button for 3 seconds.
- 2 Rotate the center dial to _h06, then press the center dial to select.
- 3 Rotate the center dial to select your desired setting, then press the center dial to select.
LO: Low temperature
M: Medium temperature (default)
HI: High temperature.

The temperature of the drink will affect the extraction of the espresso and the flavor of your drink. For best results and proper extraction, we recommended a low or medium temperature for darker roasts, and a medium or high temperature for light roasts.

STRENGTH

If you find your brew is tasting too weak or too strong for your liking, you can use the strength adjustment button.

ADJUSTING BREW STRENGTH

To adjust brew strength, press the STRENGTH button. The strength adjustment will work differently depending on if you are brewing espresso or coffee.



Espresso Strength Adjustments:

- ○ ○ Taller, less concentrated: 4:1 water to grounds ratio.
- ● ○ Default: 2.5:1 water to grounds ratio.
- ● ● Shorter, more concentrated: 2:1 water to grounds ratio.

Coffee Strength Adjustments:

- ○ ○ Mild: Less beans will be ground.
- ● ○ Default:
- ● ● Bold: More beans will be ground.

SWITCHING OUT BEANS

SWITCHING OUT BEANS

- 1 Unlock bean hopper by rotating handle counterclockwise.

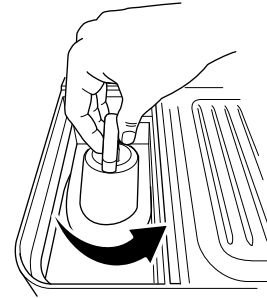

- 2 Remove the bean hopper and pour out any leftover beans.
- 3 Place the hopper back on the machine.
- 4 Lock bean hopper back in by rotating handle clockwise.

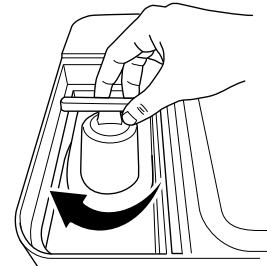

- 5 Place the portafilter with the funnel attached in the grinding cradle.
- 6 Press and hold START GRIND button to clear any leftover beans.
- 7 Add new beans into the bean hopper.

FROTHING

FROTHING

- 1 Fill the milk jug with the desired amount of milk, but do not exceed the max fill line. Ensure that whisk is installed.

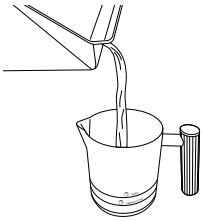

- 2 Ensure that the bottom of the milk jug is dry. Place the milk jug on the milk jug platform with the steam wand inserted into the milk jug.

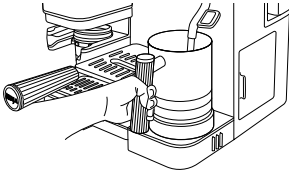

- 3 On the control panel, use the froth dial to highlight the desired froth style.



FROTH STYLES

Steamed Milk

Gently steam milk to an ideal drinking temperature without whisking. Great for coffee.

Thin Froth

A thin layer of foam for lattes.

Thick Froth

A classic layer of fluffy froth to top any drink. Great for cappuccinos.

Extra-Thick Froth*

A large layer of froth, ideal for cappuccinos and other drinks with less volume.

Cold Foam

A classic layer of cold froth to top any iced coffee or espresso drink.

*Not available on all models.

- 4 Next, select DAIRY or PLANT-BASED milk with the MILK TYPE button based on the milk that is in the milk jug. Press START FROTH. The machine will beep to signal that the frothing has started. The progress bar will illuminate to indicate the status of the frothing. The machine will beep again to signify the froth is complete.

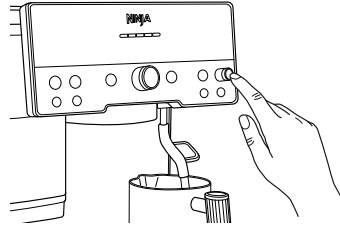

NOTE: DO NOT froth milk directly into the espresso or coffee; always froth in the milk jug and pour the froth into the espresso or coffee base afterwards.

NOTE: DO NOT froth without the main drip tray inserted.

NOTE: If you would like to change the temperature of your froth, see Additional Settings.

AFTER YOU FINISH FROTHING

- 5 Once you remove the milk jug, immediately wipe the steam wand with a damp cloth before pushing it back down into its down position.

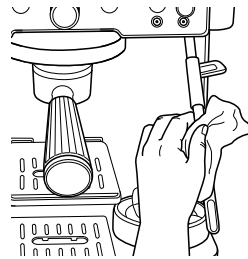

- 6 When the steam wand is pushed back into its down position, auto purging will occur. This is to clean the inside of the steam wand. The machine will beep to signal that the purge has started. When finished, the machine will beep again. You can purge at any time by pressing the PURGE button when steam wand is in down position.



NOTE: When out of water, the machine will not purge. Be sure to press the PURGE button when adding more water in to complete purge.

- 7 Before pouring milk, tap the jug on a flat surface and swirl around to remove large bubbles. Pour frothed milk over espresso or coffee and enjoy.

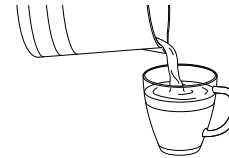

FROTH QUEUING

After you have started your brew, you are able to queue up your froth to start immediately after the brew is finished.

- 1 Fill the milk jug with the desired amount of milk, but do not exceed the max fill line.
- 2 While brewing, select DAIRY or PLANT-BASED milk with the MILK TYPE button and froth setting with the froth dial.
- 3 Press START FROTH.

Cold foam  does not need to be queued and can froth while the machine is brewing.

MANUAL FROTHING

- 1 Fill the milk jug as desired in between the min and max fill lines.
- 2 Make sure you are on the steamed milk setting .
- 3 Pull the steam wand out. Place the steam wand inside the milk jug so that the wand is resting within the milk jug spout.
- 4 Angle the milk jug slightly to the left or right so that the steam wand is about a finger's width away from the wall of the milk jug.

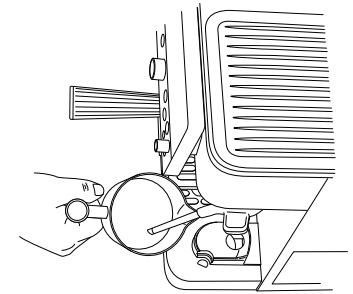

- 5 Hold START FROTH for 3 seconds. The machine will beep to indicate that frothing has started and steam will start to generate from the wand.
- 6 Place wand just below the surface of the milk to start incorporating air to stretch the volume milk. This should start to create a whirlpool with the milk.

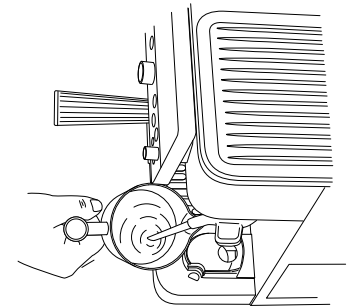

- 7 Once you feel comfortable with the volume of milk, move the jug up so the steam wand is further below the surface. This is to heat your drink up.
- 8 Stay in that position until the jug is too hot to hold with your hand, then press START FROTH to turn the function off.

PERIODIC MAINTENANCE

IMMEDIATELY AFTER BREW CLEANING

- When brew is complete, carefully remove portafilter from group head. Dispose of grounds by tapping the surface of the basket over a container or knock box (sold separately).
- For best results, be sure to clean out the portafilter and basket between each use.
- Remove basket from portafilter. Hand-wash both items with soapy water to remove all coffee oils. Be sure basket is dry before brewing again.
- After you froth, wipe the wand with a damp cloth before pushing it back into its down position.
- Push steam wand into its down position to initiate an auto purge.
- Empty the drip tray when the orange empty indicator rises enough to become visible.
- Periodically hand-wash the drip tray and air-dry thoroughly.
- Periodically clean the base of the machine with a damp cloth.

CLEANING THE ACCESSORIES

Dishwasher-Safe Parts:

Funnel, whisk, cleaning disc, water reservoir, bean hopper, and all drip tray components.

EMPTYING THE DRIP TRAY

As you brew, the drip tray will fill up. When the orange empty indicator rises enough to be visible, it's time to empty the main drip tray.

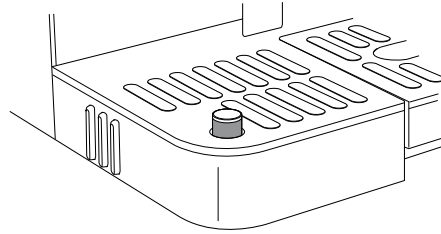

- 1 Remove the main drip tray from the machine by pulling tray away.

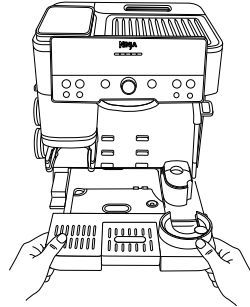

- 2 Carefully move the main drip tray to the sink and pour water out through the pour spout.

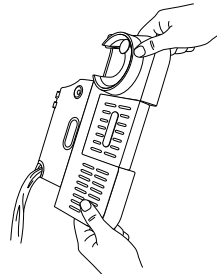

- 3 Insert drip tray back into the machine.

NOTE: Empty indicator is removable.

REMOVING THE SHOWER SCREEN AND REPLACING THE RUBBER GASKET

If you notice your brew quality diminish over time, remove the shower screen and clean it thoroughly.

If you experience leaking around the portafilter during a brew when the handle is fully tight, you may need to replace the gasket.

Be sure that the machine is turned off and unplugged before proceeding.

- 1 Using a Phillips-head screwdriver, remove central screw on shower screen, then remove shower screen.

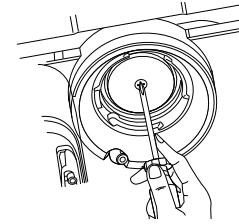

- 2 Once removed, clean the shower screen with soap and water.

- 3 Remove rubber gasket from group head with flathead screwdriver. Inspect gasket for any wear or tearing, and replace with a new gasket if needed (available for purchase on ninjakitchen.com/accessories).

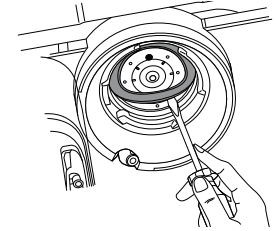

- 4 Insert shower screen back into group head and secure in position with screw.

PERIODIC MAINTENANCE CONT.

CLEANING THE CONICAL BURR GRINDER

Be sure that the machine is turned off and unplugged before proceeding.

- 1 Remove all beans from the bean hopper. See Switching Out Beans for reference.
- 2 Remove bean hopper by lifting handle and turning to counterclockwise.

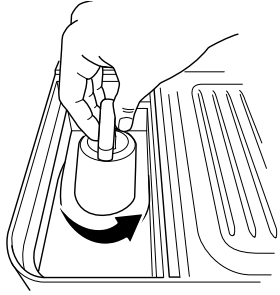

- 3 Remove upper burr by rotating counterclockwise, aligning the orange arrow on the burr grinder with the orange arrow labeled ALIGN on the machine. Once aligned, lift upper burr out.

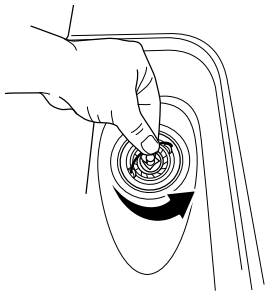

- 4 Clean removed burr grinder with brush.

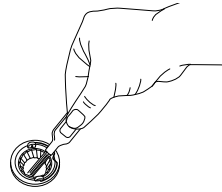

- 5 Then, clean burr grinder attached to machine with cleaning brush.

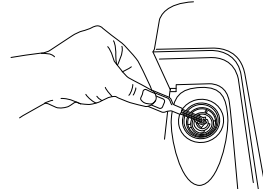

- 6 Be sure to clean the inside of the grinding cradle as well.

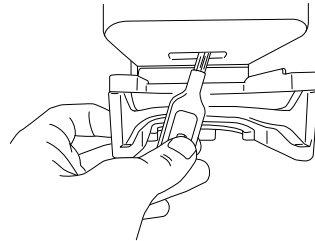

NOTE: DO NOT allow burrs to come into contact with water.

NOTE: When cleaning the burr grinder attached to the machine, only use the cleaning brush.

CLEANING THE STEAM WAND

Over time, material can build up in the steam wand.

- 1 Remove the cap on the bottom of the cleaning brush to access the needle.
- 2 Use the needle to remove any material from the steam wand tip.

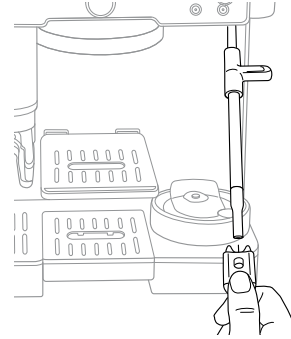

- 3 For a deeper clean, use the wrench in the middle of the cleaning brush to remove the steam wand tip.

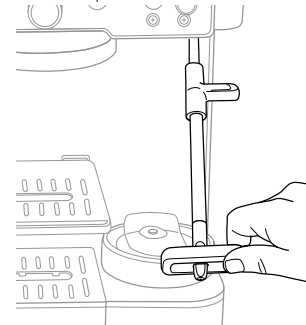

- 4 Use the needle to remove any material from inside the steam wand and steam wand tip.

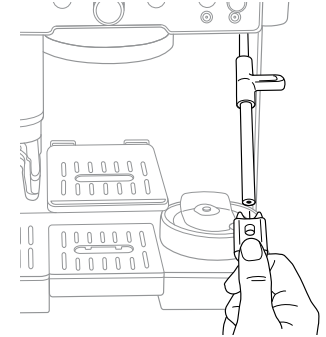

- 5 After cleaning, run a purge to clear out any excess material.

DESCALING AND CLEAN CYCLE

DESCALING

Time to complete: approximately 90 minutes.

When the DESCALE light illuminates, you must run a descale cycle. If a descale isn't performed after the light turns on, drink quality will diminish and the machine may clog and stop working.

Descaling breaks down and removes limescale and mineral buildup inside the machine. Doing this will help maintain peak performance if routinely performed with a descale solution whenever the DESCALE light turns on

- 1 Ensure the main drip tray is completely emptied, as some of the water brewed from the descale cycle will be deposited into the main drip tray. **Not emptying the main drip tray may cause overflow.**

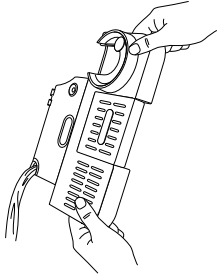

- 2 Dissolve the provided Ninja descale powder in a separate container with 37 fl. oz. of water. Pour solution mixture into water reservoir.

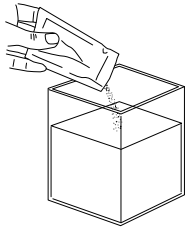

OR

Fill the water reservoir with 16 oz. of white vinegar, then fill the reservoir to the Descal line with water.

- 3 Insert the double basket into the portafilter.
- 4 Fasten the portafilter into the group head.
- 5 Ensure milk jug is placed on the milk jug platform with the steam wand inside.
- 6 Place an empty cup (at least 18 oz.) under the portafilter. You may have to remove the center drip tray.
- 7 Press the DESCALE button, then press the center dial to start the descale cycle.

- 8 The machine will start the descale cycle. The machine will flush solution through the steam wand and portafilter for approximately 90 minutes. The machine will count down the remaining time on the control panel.
- 9 The machine will beep indicating when the descale cycle is complete.
- 10 After the cycle is complete, remove the portafilter, main drip tray, and milk jug with caution, as there will be water in each.
- 11 Empty the contents of each and hand-wash with warm, soapy water to remove any solution that could affect the flavor of your coffee.
- 12 Fill the reservoir with fresh water up to, but not exceeding, the Max Fill line.
- 13 Install the main drip tray back on the machine and install the portafilter in the group head. Do not install the milk jug.
- 14 Flush the group head by running a 12 oz. CLASSIC brew.
- 15 Then, with the milk jug uninstalled, flush the steam wand by pressing the PURGE button.

RUNNING A CLEAN CYCLE

Time to complete: approximately 6 minutes

A clean cycle flushes out residual oils or grounds that are built up in and around the group head. The CLEAN light will automatically illuminate to indicate when a clean cycle is required. You may also run a clean cycle if you notice a change in brew quality. The clean cycle requires the cleaning disc (included with the machine and storable in the accessory storage) and a cleaning tablet (also included and available for purchase on ninjakitchen.com/ accessories).

Follow these steps to run a clean cycle:

- 1 Ensure the main drip tray is completely empty as the water brewed from the clean cycle will be deposited into the main drip tray. **Not emptying the main drip tray may cause overflow.**

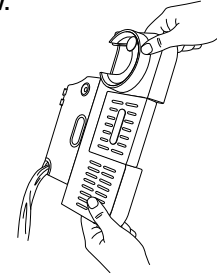

- 2 Fill the water reservoir up to but not exceeding the Max Fill line.
- 3 Insert the double basket in the portafilter.

NOTE: Empty indicator is removable.

- 4 Place the cleaning disc on top of the double basket, with the handle facing up.

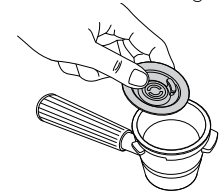

- 5 Place 1 cleaning tablet in the center of the cleaning disc.

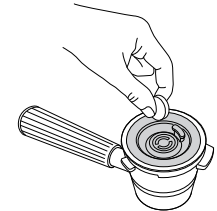

- 6 Fasten the portafilter in the group head.
- 7 Press the CLEAN button, then press the center dial to start the clean cycle.
- 8 The machine will start the process of backflushing the shower screen and group head and depositing the water and sediment from the clean cycle into the main drip tray.
- 9 The clean cycle will take approximately 6 minutes to complete. The machine will beep when the clean cycle is complete.
- 10 After the clean cycle is complete, remove both the portafilter and main drip tray with caution, as there may be water in both. Hand-wash with warm soapy water.

BEST BREWING PRACTICES

- For best results, use freshly roasted coffee beans.
- When purchasing coffee beans, it's best to buy a bag with a "Roasted On" date rather than a "Best Before" date to ensure quality and freshness.
- We recommend you use any coffee beans within 20 days of the "Roasted On" date.
- When changing to a different bean, fully remove previous beans before proceeding. See the Switching Out Beans section for more information.
- Always match the current to the recommended grind setting.
- To increase the brew temperature, run a water flush before making your drink.
- Keep your machine clean by using the brush to wipe off any debris.
- Use filtered water.
- Dial in the grinder whenever switching out beans.
- Keep machine on a stable surface.
- Empty drip tray frequently.
- After you grind and before you start brewing, the machine will start to heat up. Place your mug on the heated cup tray to warm it up.

BEST FROTHING PRACTICES

- For best results with plant-based milk, use the barista or full-fat version.
- For dairy milk, we recommend using whole milk.
- Milks that are UHT-treated (Ultra High Temperature) may have varying results.
- Coconut milk can be heated up but will not make stable froth.
- If you would like to adjust milk temperature, please see Additional Settings section.
- For best results use cold milk or milk out of the refrigerator.
- For best results make sure the milk jug is at room-temperature before frothing.
- Ensure both the milk jug platform and the bottom of the milk jug are dry and clean before placing on the milk jug platform.
- Wipe steam wand with a damp cloth immediately after use to prevent milk from sticking.
- Before turning off the machine, push the steam wand back into the down position to allow it to purge.
- For a deeper clean of the whisk and steam wand, fill milk jug to the max line with water and a drop of dish soap and run the THIN FROTH  program.
- For best foams and latte art, tap and swirl the milk jug prior to pouring milk.
- For best plant-based froth, use the PLANT-BASED setting.

ADDITIONAL SETTINGS

The additional settings menu offers additional options to customize your machine and is accessible by pressing and holding the SIZE button for 3 seconds.

Item Number	Topic	Options
_h01	Beeps: Turns all beeps on or off.	ON: Leaves beeps on (Default) OFF: Turns beeps off
_h02	Eco Mode: Saves power by turning boiler off after brewing.	ON: Turns Eco Mode on OFF: Leaves Eco Mode off (Default)
_h03	Recommended Grind Size: Turns recommended grind setting display on or off.	ON: Leaves display on (Default) OFF: Turns display off
_h04	Barista Assist Technology™ Reset: Resets recommended grind setting to default setting.	NO: Keeps your current settings (Default) YES: Resets your settings
_h05	Factory Settings Reset: Reset all variables on the machine to default settings.	NO: Keeps your current settings YES: Resets your settings
_h06	Brew Temperature: Adjusts the temperature of your drink.	LO: Low temperature M: Medium temperature (default) HI: High temperature
_h07	Froth Temperature: Adjusts the temperature of your froth.	LO: Low temperature M: Medium temperature (default) HI: High temperature
_h08	Hard Water: Brings the hard water test menu up to reset your water hardness.	hd 0: Strip has 0 purple boxes hd 1: Strip has 1 purple box hd 2: Strip has 2 purple boxes hd 3: Strip has 3 purple boxes hd 4: Strip has 4 purple boxes hd 5: Strip has 5 purple boxes

- 1 Navigate through these topics by turning the center dial. Press START BREW to select your desired topic.
- 2 Once you select into a topic, turn the center dial to get to your desired option and press START BREW to make your selection.
- 3 After a selection is made, you will hear a beep and return to the menu screen. Please note that the machine will not beep if beeps are turned off.
- 4 You can exit the menu by pressing the SIZE button again.

TROUBLESHOOTING GUIDE

Why is there no water coming out of the portafilter?

Several factors could affect the volume of water dispensing from the portafilter:

- Not enough water in the reservoir: Ensure the water reservoir is adequately filled. When using the luxe basket, 18 oz. of water is required. When using the double or single basket, fill to the min. line.
- The water reservoir is not seated firmly: Check that the water reservoir is firmly seated in its place on the back of the machine.
- The machine is warming up/reaching the operating temperature: Please allow a short time for the machine to warm up before it dispenses.
- The grind size is too fine: Let the brew time out and follow the recommended grind setting on your next brew.
- The machine needs to be descaled: Follow the instructions under the Cleaning & Maintenance section.

Why is the espresso stream small/flowing slowly?

There could be several reasons behind this.

- The grind size is too fine: Let the brew time out and follow the recommended grind setting on your next brew.
- Basket cleanliness: Before grinding, ensure the basket is free of any clogs or debris that could impede the flow.
- The machine needs to be descaled: Follow the instructions under the Cleaning & Maintenance section.

Why is the espresso stream flowing very fast?

- The grind size is too coarse: Let the brew time out and follow the recommended grind setting on your next brew.
- Coffee is tamped too lightly: When tamping, make sure to place the portafilter on a level surface. Place the assisted tamper inside the funnel and push down on it until you feel the tamper contact the funnel.

Why does the espresso run around the edge of the portafilter?

- Portafilter is not inserted into the group head correctly: Place portafilter into group head by aligning orange dot on portafilter with orange dot on group head. Fasten portafilter into group head until orange dot on portafilter aligns with lock arrow on group head.
- There are coffee grounds around the basket rim: Clean unwanted grounds from the edge of the basket and portafilter to ensure portafilter sits properly in group head.
- The group head seal needs to be replaced: Call Customer Service at 1-877-646-5288.

Frothing does not start.

- Machine has not reached operating temperature: Please allow a short time for the machine to warm up before frothing begins.
- Not enough water in the reservoir: Ensure the water reservoir is filled up to the min. line.
- The water reservoir is not seated firmly: Check that the water reservoir is firmly seated in its place on the back of the machine.
- Wand is not inserted down: Ensure the steam wand is inserted into the milk jug, with the milk jug properly seated on the platform.
- Not enough milk in the milk jug: Ensure milk is filled up to the min. line.

Coffee is not hot enough.

- Preheat the portafilter: Rinse the portafilter under hot water before grinding. Please make sure that the basket is completely dry before grinding.
- Preheat the cup: Rinse the cup under hot water before brewing to increase the temperature of the brew.
- Adjust water temperature: Increase the temperature of the brew by using the BREW TEMP button on the control panel.
- Use heated froth settings: All froth settings are heated except cold foam, which is denoted with a snowflake.
- The machine needs to be descaled: Follow the instructions under the Cleaning & Maintenance section.

TROUBLESHOOTING GUIDE CONT.

Why am I not getting any crema?

- Coffee is tamped too lightly: When tamping, make sure to place the portafilter on a level surface. Place the assisted tamper inside the funnel and push down on the tamper until you feel it contact the funnel.
- The grind size is too coarse: Let the brew time out and follow the recommended grind setting on your next brew.
- Coffee beans are not fresh: Bean freshness will impact the crema quality. When purchasing coffee beans, it's best to buy a bag with a "Roasted On" date rather than a "Best Before" date to ensure quality and freshness. We recommend you use coffee beans within 20 days of the "Roasted On" date.
- Basket may be clogged/holes are blocked: Ensure you are cleaning the baskets frequently. Make sure none of the holes in the bottom of the basket are clogged with grounds.

Why does the drip tray fill quickly?

- To ensure the machine maintains the ideal pressure for espresso, during a brew, some water will bypass into the main drip tray. This is normal.
- The machine will automatically purge water from the steam wand into the main drip tray after each froth. This is to clean the inside of the steam wand.
- The main drip tray is designed to hold the water bypass from the creation of up to 6 cappuccinos.

Why does the machine make a pulsing/thumping sound while brewing?

- Not enough water in the reservoir: Ensure the water reservoir is filled up to the min. line.
- The water reservoir is not seated firmly: Check that the water reservoir is firmly seated in its place on the back of the machine.
- If the reservoir has water filled over the min. line and is seated firmly, some water pump noise is considered normal.
- You may also hear this noise while frothing. This is normal.

Machine is leaking.

- The machine will automatically purge water from the steam wand into the main drip tray after each froth. This is to clean the inside of the steam wand.
- Drip tray is full: Check the empty indicator to see if you need to empty the main drip tray. Follow the instructions under the Cleaning & Maintenance section.
- The water reservoir is not seated firmly: Check that the water reservoir is firmly seated in its place on the back of the machine.
- Group head seal needs to be replaced: Call Customer Service at 1-877-646-5288.

Machine has no power.

- Ensure the machine is plugged into a working outlet.
- After plugging the machine in, press the POWER button.
- To save power, the machine will automatically shut off after 20 minutes.

There are no coffee grounds coming from the grinder.

- Check if you have beans in the bean hopper.
- Press START GRIND to begin grinding.
- If there are beans in the bean hopper and you are getting an ADD BEANS notification, unplug the machine and gently push the beans down toward the burrs.
- Ensure the bean hopper is securely and properly inserted.
- Ensure the portafilter with the funnel assembled is properly installed into the grinding cradle. Remove and reinsert to ensure it is installed correctly.
- Using the cleaning brush, clear out any material sitting inside the grinding cradle.

Grinder is making a loud noise.

- If the grinder is making a loud noise, it could be due to unintended debris. Use only whole beans in the grinder and avoid putting cold or frozen beans in.

Portafilter will not insert into group head.

- Portafilter is not properly aligned: Place the portafilter into the group head by aligning the orange dot on the portafilter with the orange dot on the group head. Fasten the portafilter into the group head until the orange dot on the portafilter aligns with the lock arrow on the group head.
- Coffee is tamped too lightly: When tamping, place the portafilter on a level surface. Place the assisted tamper inside the funnel and push down on the tamper until you feel it contact the funnel.

Unable to lock bean hopper in position.

- This may be caused by the grinder being blocked by beans or moisture clogging the grinder. Try clearing any beans blocking the grinder and ensure the grinder is dry and free from moisture.

I matched the grind setting, but the output was not good.

- Refer to Dialing in Your Grinder for Proper Extraction section.

Bean hopper will not fit back onto the machine.

- Ensure beans on top of the grinder are not blocking the hopper from seating properly. If beans are blocking the hopper, you may need to clear them before reseating the hopper on the machine.

Milk froth is not hot enough.

- The milk froth temperature is dependent on the froth style selected. COLD FOAM, denoted by a snowflake next to the milk jug, will not get hot.
- Steam wand is clogged.
 - Remove tip of wand with the wrench on the brush.
 - Use needle on the bottom of cleaning brush to clean inside of wand.
- The Additional Settings menu offers options to customize the froth temperature and is accessible by pressing and holding the SIZE button for 3 seconds.
 - Select option _h07 Froth Temperature: this allows you to adjust the frother temperature to low (L), medium (M), or high (H). Use the center dial to make your selection, then hold the SIZE button for 3 seconds to exit the menu.

Milk froth is too thin or thick.

- Change the froth setting using the froth dial. Refer to the Frothing section for more information on froth settings.
- Milk type: Different milks have different fat contents. The higher the fat content of the milk, the thicker the froth will be.
- Dairy vs Plant Based: To improve the overall quality of the froth, select DAIRY or PLANT-BASED milk with the MILK TYPE button based on the milk type you are frothing.
- For additional froth information, refer to the Best Frothing Practices section.

My drink is smaller/larger than expected.

- If you're brewing an espresso drink, you can change the grounds-to-water ratio. Please refer to the Additional Settings section.
- If you're brewing a coffee drink, select the desired size using the SIZE button before grinding.
- Basket may be clogged/holes are blocked: Ensure you are cleaning the baskets frequently. Make sure none of the holes in the bottom of the basket are clogged with grounds.
- The machine needs to be descaled: Follow the instructions under the Cleaning & Maintenance section.

My drink is too bitter/acidic.

- Match grind setting: Use the grind dial on the side of the machine to match the Current grind setting to the Recommended grind setting on the control panel before grinding.
- Change ratio: To increase/decrease the grounds-to-water ratio, please refer to the Additional Settings section.
- Change the brew temperature: For dark-roast beans, we recommend using the low or medium temperature setting. For medium- or light-roast beans, we recommend using the medium or high temperature setting.

TROUBLESHOOTING GUIDE CONT.

ALL ERROR MESSAGES (ADD WATER, ADD BEANS, ETC.)

ADD WATER notification.

- Ensure there is water in the reservoir. If the reservoir is empty, add fresh water to the reservoir and then press START BREW to resume the brew.
- If the reservoir is filled with water, remove and reseal the reservoir and then press START BREW to resume the brew.

ADD BEANS notification

- Check if there are enough beans in the bean hopper to make your drink.
- If there are beans in the bean hopper, and you are getting an ADD BEANS notification, unplug the machine and gently push the beans down toward the burrs.

INSTALL PORTAFILTER notification

- Make sure the portafilter is sitting flat on the grinding cradle.
- Make sure portafilter is pushed all the way back in grinding cradle.
- Use the cleaning brush to ensure grinding cradle is clear of any grounds.
- Unplug the machine and plug it back in.

INSTALL FUNNEL notification

- Ensure funnel is properly installed on portafilter by aligning the notches on the funnel with the notches on the portafilter.
- When inserting portafilter into grinding cradle, ensure funnel is attached to portafilter.
- Unplug the machine and plug it back in.

INSTALL HOPPER notification

- Lock bean hopper in by rotating handle clockwise.
- If issue continues, please unlock the hopper by turning the handle counterclockwise. Lift the bean hopper off the base and reseal it firmly onto the base. You may need clear beans from the top of the grinder before reinstalling the bean hopper in order to seat it properly. Lock the bean hopper by turning the handle clockwise.

INSTALL JUG notification

- Ensure milk jug is on platform when frothing.
- Make sure both the bottom of the jug and milk jug platform are dry and clean.

RINSE notification

- If you try to brew a cold drink after a hot drink, you may get a RINSE notification. Refer to RINSE notification in the Using The Machine section.

DESCALE notification

- It is time to descale the machine. Refer to Descaling in the Cleaning & Maintenance section.

CLEAN notification

- It is time to run a clean cycle. Refer to Running a Clean Cycle in the Cleaning & Maintenance section.

Er

- If the control panel displays “Er” and then a number (ex. “Er 03”), contact Customer Service at 1-877-646-5288.

PRODUCT REGISTRATION

Please visit registryourninja.com or call 1-877-646-5288 to register your new Ninja® product within ten (10) days of purchase. You will be asked to provide the store name, date of purchase, and model number along with your name and address.

The registration will enable us to contact you in the unlikely event of a product safety notification. By registering, you acknowledge you have read and understood the instructions for use and warnings set forth in the accompanying instructions.

REPLACEMENT PARTS

To order additional parts and accessories, visit ninjaaccessories.com or contact Customer Service at 1-877-646-5288.

Shark NINJA

NINJA LUXE CAFÉ ONE (1) YEAR LIMITED WARRANTY NJA_1_YR_IB_LMTD_WRNTY_ES_US_ENG

SharkNinja's mission is focused on positively impacting people's lives every day in every home around the world. We stand by our products and offer exclusive warranties to our customers. Visit our product detail page for information on the warranty offered.

Ninja Luxe Café 1-Year Limited Warranty

The One (1) Year Limited Warranty applies to purchases made from authorized retailers of SharkNinja Operating LLC. Warranty coverage applies to the original owner and to the original product only and is not transferable.

SharkNinja warrants that the unit shall be free from defects in material and workmanship for a period of one (1) year from the date of purchase when it is used under normal household conditions and maintained according to the requirements outlined in the Owner's Guide, subject to the following conditions and exclusions:

What is covered by this warranty?

1. The original unit and/or non-wearable parts deemed defective, in SharkNinja's sole discretion, will be repaired or replaced up to one (1) year from the original purchase date.
2. SharkNinja may, in its sole discretion, (i) repair the original unit and/or non-wearable parts with new or refurbished parts or units or (ii) replace the original unit with a new or refurbished unit. Refurbished products or parts will be comparable in performance and function to an original unit or part.
3. In the event a replacement unit is issued, the warranty coverage ends six (6) months following the receipt date of the replacement unit or the remainder of the original unit's warranty, whichever is later. SharkNinja reserves the right to replace the original unit with one of equal or greater value.

What is not covered by this warranty?

1. Normal wear and tear of wearable parts (such as funnel, water reservoir, water reservoir lid, bean hopper, bean hopper lid, etc.), which require regular maintenance and/or replacement to ensure the proper functioning of your unit, are not covered by this warranty. Replacement parts are available for purchase at support.ninjakitchen.com.
2. Any unit that has been tampered with or used for commercial purposes.
3. Damage caused by misuse, abuse, negligent handling, failure to perform required maintenance (e.g., failure to keep the well of the motor base clear of food spills and other debris), or damage due to mishandling in transit.
4. Consequential and incidental damages.
5. Defects caused by repair persons not authorized by SharkNinja. These defects include damages caused in the process of shipping, altering, or repairing the SharkNinja product (or any of its parts) when the repair is performed by a repair person not authorized by SharkNinja.
6. Products purchased, used or operated outside of North America.

How to get service

If your appliance fails to operate properly while in use under normal household conditions within the warranty period, visit support.ninjakitchen.com for product care and maintenance self-help. Our Customer Service Specialists are also available at 1-877-646-5288 to assist with product support and warranty service options, including the possibility of upgrading to our VIP warranty service options for select product categories. So we may better assist you, please register your product online at registryourninja.com and have the product on hand when you call.

SharkNinja will cover the cost for the customer to send in the unit to us for repair or replacement. A fee of \$20.95 (subject to change) will be charged when SharkNinja ships the repaired or replacement unit.

How to initiate a warranty claim

You must call 1-877-646-5288 to initiate a warranty claim. You will need the receipt as proof of purchase. We also ask that you register your product online at registryourninja.com and have the product on hand when you call, so we may better assist you. A Customer Service Specialist will provide you with return and packing instruction information.

How state law applies

This warranty gives you specific legal rights, and you also may have other rights that vary from state to state. Some states do not permit the exclusion or limitation of incidental or consequential damages, so the above may not apply to you.