



BAR 1300XMK2



OWNER'S MANUAL

IMPORTANT SAFETY INSTRUCTIONS

Verify Line Voltage Before Use

The JBL Bar 1300XMK2 (soundbar, detachable speakers and subwoofer) has been designed for use with 100-240V AC, 50/60Hz. Connection to a line voltage other than that for which your product is intended can create a safety and fire hazard and may damage the unit. If you have any questions about the voltage requirements for your specific model or about the line voltage in your area, contact your retailer or customer service representative before plugging the unit into a wall outlet.

Do Not Use Extension Cords

To avoid safety hazards, use only the power cord supplied with your unit. We do not recommend that extension cords be used with this product. As with all electrical devices, do not run power cords under rugs or carpets, or place heavy objects on them. Damaged power cords should be replaced immediately by an authorized service center with a cord that meets factory specifications.

Handle the AC Power Cord Gently

When disconnecting the power cord from an AC outlet, always pull the plug; never pull the cord. If you do not intend to use this speaker for any considerable length of time, disconnect the plug from the AC outlet.

Do Not Open the Cabinet

There are no user-serviceable components inside this product. Opening the cabinet may present a shock hazard, and any modification to the product will void your warranty. If water accidentally falls inside the unit, disconnect it from the AC power source immediately, and consult an authorized service center.



To protect battery lifespan, fully charge at least once every 3 months. Battery life will vary due to usage patterns and environmental conditions.



WARNING

DO NOT ATTEMPT TO OPEN, SERVICE, OR DISASSEMBLE THE BATTERY | DO NOT SHORT CIRCUIT | MAY EXPLODE IF DISPOSED OF IN FIRE | RISK OF EXPLOSION IF BATTERY IS REPLACED BY AN INCORRECT TYPE | DISPOSE OR RECYCLE USED BATTERIES ACCORDING TO THE INSTRUCTIONS

TABLE OF CONTENTS

IMPORTANT SAFETY INSTRUCTIONS 2

1. INTRODUCTION 4

2. WHAT'S IN THE BOX 5

3. PRODUCT OVERVIEW 6

- 3.1 Soundbar 6
 - 3.2 Detachable speakers 6
 - 3.3 Subwoofer 7
 - 3.4 Remote control 8
-

4. PLACE 9

- 4.1 Desktop placement 9
 - 4.2 Wall-mounting 9
-

5. CONNECT 10

- 5.1 Connect with your TV and digital devices 10
 - 5.2 Connect to your Bluetooth device 11
 - 5.3 Connect to your home network 12
-

6. SETUP 13

- 6.1 Connect the detachable rear speakers and subwoofer 13
 - 6.2 Charge the detachable speakers 13
 - 6.3 3D surround sound 14
 - 6.4 Use the detachable speakers 16
-

7. PLAY 18

- 7.1 Switch on/Auto standby/Auto wakeup 18
- 7.2 Play from the TV source 18
- 7.3 Play from the HDMI IN source 19
- 7.4 Play from the Bluetooth source 19
- 7.5 Play over your home network 20
- 7.6 Multi-room playback 21

8. ADVANCED USAGE 22

- 8.1 Audio sync 22
 - 8.2 Multi-speaker connection (Detachable speakers) 22
-

9. RESTORE FACTORY SETTINGS 23

10. SOFTWARE UPDATE 23

11. RE-CONNECT THE SUBWOOFER 24

12. PRODUCT SPECIFICATIONS 24

13. TROUBLESHOOTING 25

14. TRADEMARKS 27

15. OPEN SOURCE LICENSE NOTICE 28

1. INTRODUCTION

Thank you for purchasing the JBL Bar 1300XMK2 (soundbar, detachable speakers and subwoofer) which is designed to bring an extraordinary 3D sound experience to your home entertainment system. We encourage you to take a few minutes to read through this manual, which describes the product and includes step-by-step instructions for setting up and getting started.

To make the most of product features and support, you may need to update the product software through the Internet in the future. Refer to the software update section in this manual to ensure that your product has the latest software.

Designs and specifications are subject to change without notice. If you have any questions about the soundbar, installation or operation, please contact your retailer or customer service representative, or visit our website: www.jbl.com.

JBL One app

With the JBL One app, you can

- easily complete product setup;
- connect *music streaming services;
- discover new music with integrated music services;
- access software updates when they are available;
- personalize audio settings;
- access additional features.

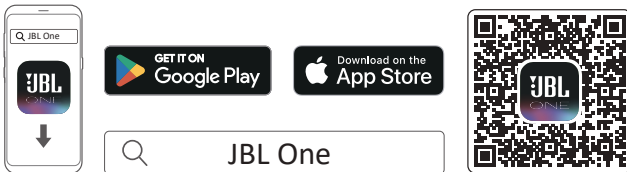

For more information, see “[5.3 Connect to your home network](#)” and “[7.5 Play over your home network](#)”.

NOTES:

- *Subscription may be needed and not provided by the JBL One app.
- App screens in this Owner’s Manual may vary due to software updates. Always follow the app instructions.

2. WHAT'S IN THE BOX

Unpack the box carefully and ensure that the following parts are included. If any part is damaged or missing, do not use it and contact your retailer or customer service representative.

Soundbar

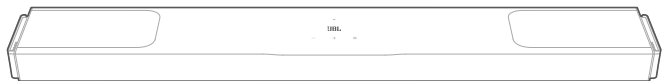

Subwoofer

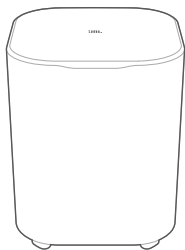

Detachable speakers (with rechargeable battery)



Remote control (with 2 AAA batteries)

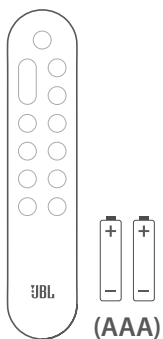

Power cord*

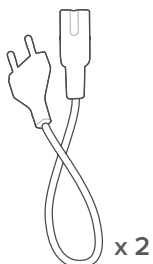

* Power cord quantity and plug type vary by regions.

HDMI cable (1.2 m/3.9 ft)

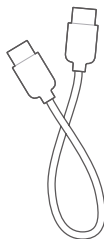

Side caps



Side caps



Wall-mounting kit

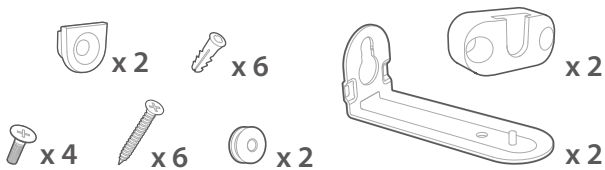

Product information & wall-mounting template

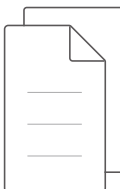

3. PRODUCT OVERVIEW

3.1 Soundbar

3.1.1 Front panel & Top panel

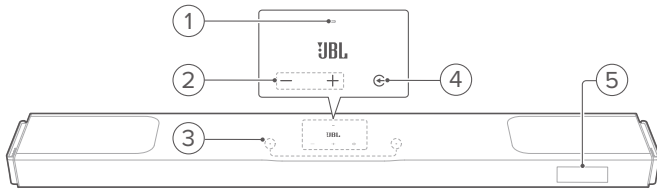

1) Status indicator

System:		
	Regular pulsing (white)	System startup
	Fast pulsing (white)	Software updating in progress
	Solid (amber)	Restoring factory settings
Network connection:		
	Slow pulsing (white)	Wi-Fi setup mode, or network disconnected
	Solid (white)	Network connected
	Solid (yellow)	Weak Wi-Fi connection

2) **-/+ (Volume)**

- Wake up the soundbar.
- Decrease or increase the volume.
- Press the two buttons together to mute or unmute.
- Hold the two buttons together for more than 10 seconds to enter Wi-Fi setup mode.

3) **Microphone**

- For sound calibration

4) **⏮ (Source)**

- Wake up the soundbar.
- Select a sound source: **TV** (default, for audio input from TV connection where the **HDMI** connector is prioritized over the **OPTICAL** connector), Bluetooth or **HDMI IN**.
- Hold for more than 3 seconds to enter Bluetooth pairing mode.

5) **Status display**

3.1.2 Back panel

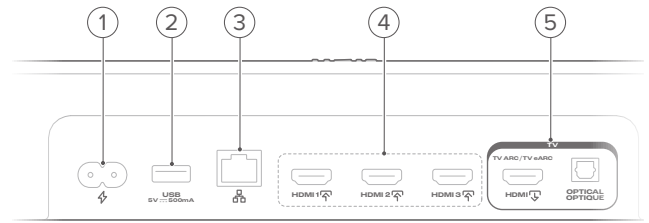

1)

- Connect to power (with the supplied power cord).

2) **USB**

- USB connector for software update (for service only).
- Connect to USB storage device for MP3 file playback (for US and APAC versions; for other versions, USB is for service only).

3)

- Connect to your home network through an Ethernet cable.

4) **HDMI (1/ 2 / 3)**

- Connect to the HDMI output on your digital device.

5) **TV connectors**

HDMI

- Connect to the HDMI ARC / HDMI eARC input on your TV.

OPTICAL **OPTIQUE**

- Connect to the optical output on your TV or digital device.

3.2 Detachable speakers

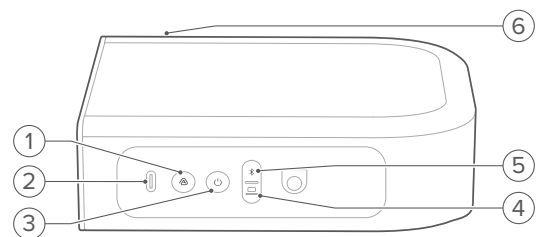

1)

- Press to enable or disable multi-speaker connection.

2) **USB Type-C connector**

- For battery charging



3) **(Power)**

- Press to switch on.
- Hold for more than 3 seconds to switch off.

4) **(Soundbar mode)**

- Press to switch to the soundbar mode (for the detachable speakers to work as the rear surround speakers of the soundbar).



- Source indicator

	Regular flashing (white)	Soundbar mode selected / Connecting to the soundbar
	Solid (white)	Connected to the soundbar

5) (Bluetooth mode)

- Press to switch to the Bluetooth mode (for the detachable speakers to work as standalone Bluetooth speakers).



- Source indicator

	Regular flashing (blue)	Bluetooth pairing / reconnecting
	Solid (blue)	Bluetooth connected
	Slow flashing (blue)	Bluetooth not connected



- In the Bluetooth mode, press to enter the Bluetooth pairing mode.
- In the Bluetooth mode, hold for more than 5 seconds to enter the Bluetooth Stereo pairing mode (to connect to the other detachable speaker and set up a Bluetooth stereo system).

6) Status indicator



- For battery power

	Flashing (red)	Low battery
	Solid (red)	Battery charging in progress

- For wireless connection status

	Regular flashing (white)	Soundbar mode selected / Connecting to the soundbar
	Solid (white)	Connected to the soundbar

- For Bluetooth Stereo pairing



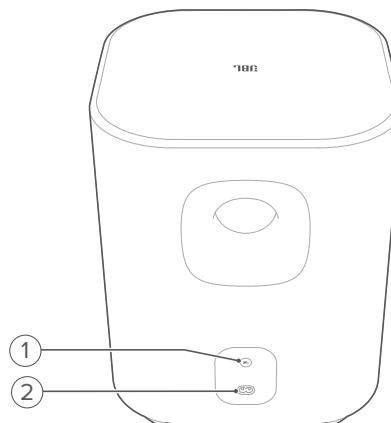

	Fast flashing (cyan)	Connecting to the other detachable speaker (Bluetooth Stereo pairing mode)
	Solid (cyan)	Connected to the other detachable speaker (Bluetooth Stereo connected)

3.3 Subwoofer



1)

- Connection status indicator

	Solid (white)	Connected to the soundbar
	Fast flashing (white)	Pairing mode
	Regular flashing (white)	Reconnecting mode
	Solid (amber)	Standby mode

2) Power connector

- Connect to power (with the supplied power cord).

3.4 Remote control

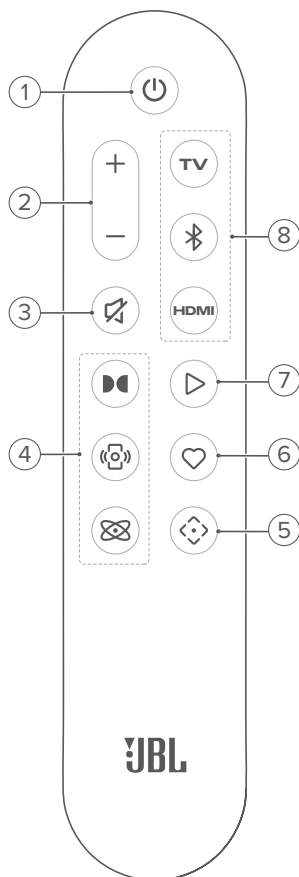

- 1)
 - Switch on or to standby.
- 2)
 - Press to increase or decrease the volume.
 - Hold to increase or decrease the volume continuously.
- 3) **(Mute)**
 - Mute / unmute.
- 4) **Sound effect buttons**
 - Select the level of Dolby Atmos® / DTS:X® effect: middle (default), high or low.
 - Select the bass level for subwoofer: 1/2/3 (default)/4/5.
 - (available when both of the detachable rear speakers are undocked from the soundbar)
 - Select the surround sound level for rear speakers: middle (default), high, muted or low.
- 5)
 - Start sound calibration.

- 6) **(Moment)**
 - Press to directly access the playlist or speaker settings that you have personalized in the JBL One app.
- 7) **(Playback controls for Wi-Fi music streaming or Bluetooth)**
 - Single press: Pause or resume playback
 - Double press: Next track
 - Triple press: Previous track
- 8) **Source selectors**
 - TV**
 - Select the **TV** source (default, for audio input from TV connection where the **HDMI** connector is prioritized over the **OPTICAL** connector)
 - (Bluetooth)**
 - Press to select the Bluetooth source.
 - Hold for more than 3 seconds to enter Bluetooth pairing mode.
 - HDMI**
 - Repeatedly press to switch between the **HDMI IN** sources: HDMI 1(default)/2/3.

4. PLACE

4.1 Desktop placement

Place the soundbar, detachable speakers and subwoofer on a flat and stable surface. Refer to the recommended distance in the following diagram.

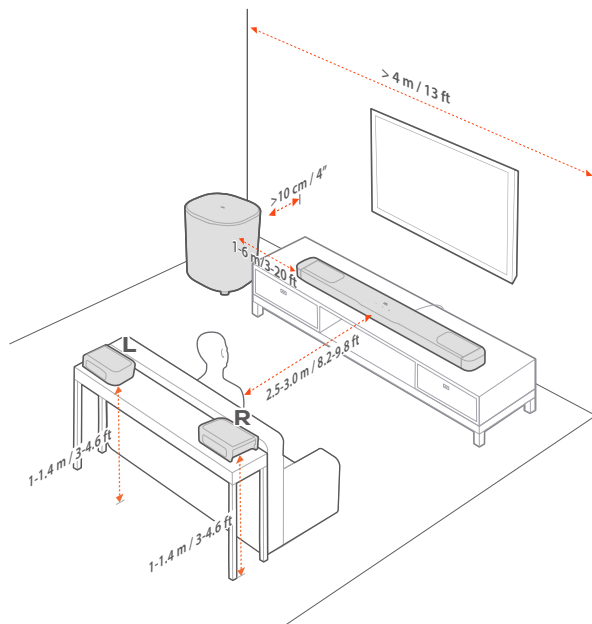

NOTES:

- The power cord shall be properly connected to power.
- Do not place any objects on the top of the soundbar, detachable speakers or subwoofer.
- Charge the detachable speakers in time to ensure sufficient battery power (See “6.2 Charge the detachable speakers”).
- Use the supplied side caps to cover the two ends of the soundbar after undocking the rear surround speakers (See Step 6 under “4.2.2 Wall-mount the detachable speakers as rear surround speakers”).

4.2 Wall-mounting

Wall-mount the soundbar and detachable rear speakers together or separately.

4.2.1 Wall-mount the soundbar

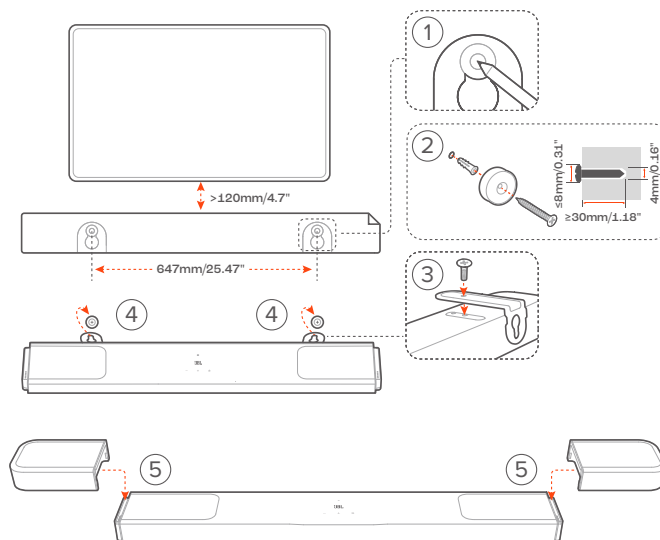

1. Preparation:

- a) With the distance of about 120mm / 4.7", stick the supplied wall-mounting template to a wall by using adhesive tapes.
- b) Use your ballpen tip to mark the screw holder location. Remove the template.
- c) On the marked location, drill a 4 mm / 0.16" hole.

2. Install the support for wall-mounting bracket.

3. With the screw, fasten the wall-mounting bracket onto the bottom of the soundbar.

4. Mount the soundbar.

5. After the soundbar is securely wall-mounted, dock the two detachable speakers onto the soundbar.

NOTES:

- Make sure that the wall can support the weight of the soundbar.
- Install on a vertical wall only.
- Avoid a location under high temperature or humidity.
- Before wall-mounting, make sure that cables can be properly connected between the soundbar and external devices.
- Before wall-mounting, make sure that the soundbar is unplugged from power. Otherwise, it may cause an electric shock.
- To move the soundbar, first remove the two detachable speakers to avoid accidental damage.
- Use the supplied side caps to cover the two ends of the soundbar after undocking the rear surround speakers (See Step 6 under “4.2.2 Wall-mount the detachable speakers as rear surround speakers”).

4.2.2 Wall-mount the detachable speakers as rear surround speakers

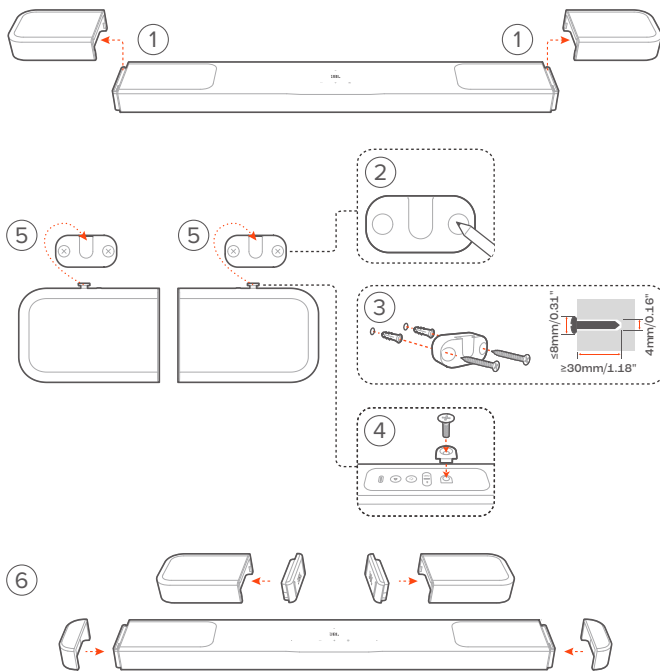

1. From the soundbar, remove the two detachable speakers.
2. Use your ballpen tip to mark the location.
3. Install the wall-mounting bracket.
4. Fasten the support onto the back of the speakers.
5. Mount the speakers.
6. Install the side caps as needed.

5. CONNECT

5.1 Connect with your TV and digital devices

For audio playback through the soundbar, connect the soundbar with your TV through the supplied HDMI cable or an optical cable (sold separately).

An HDMI connection supports digital audio and video with a single connection. HDMI connectivity is the best option for your soundbar.

NOTES:

- When both HDMI and optical cables are connected to the soundbar for audio input from TV connection, the HDMI connection is prioritized.
- Full compatibility with all HDMI-CEC devices is not guaranteed.
- With the 6 up-firing speakers and the detachable surround speaker design, the Dolby surround upmixer of the soundbar can expand the legacy channel-based audio of Dolby Digital format, including 5.1 and 7.1 content, and provide an immersive 3D Atmos experience.
- * The HDMI cable (for digital device connection) and the optical cable are sold separately.

5.1.1 TV (HDMI eARC)

(Recommended connection for the best Dolby Atmos experience)

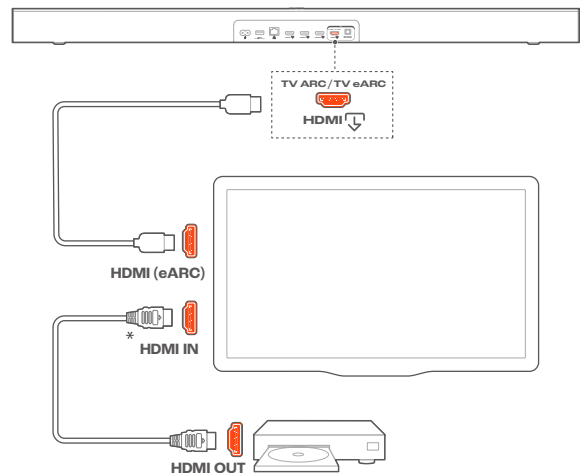

1. Connect the soundbar with the **HDMI IN (eARC)** connector on your TV by using the supplied HDMI cable.
 - On your TV, check that HDMI-CEC and HDMI eARC have been enabled. Refer to the owner's manual of your TV for more information.
2. Use an HDMI cable (V2.0 or later) to connect your TV with your digital device, such as a streaming device, set-top box, DVD/Blu-ray player or game console.
 - On your digital device, check that HDMI-CEC has been enabled. Refer to the owner's manual of your digital device for more information.
 - On your TV and digital device, select "Bitstream" or "Raw data" in the audio output settings for the best Dolby Atmos experience.

NOTE:

- To play audio from the digital device connected to your TV, select the **TV** source (See "[7.2 Play from the TV source](#)").

5.1.2 TV (HDMI ARC)

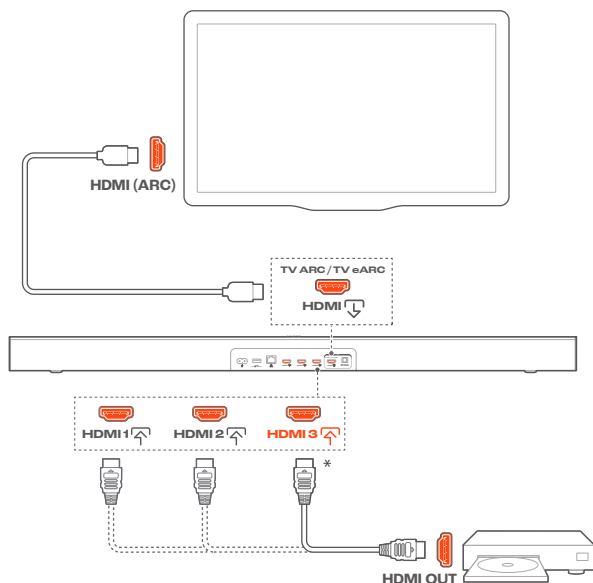

1. Connect the soundbar with the **HDMI IN (ARC)** connector on your TV by using the supplied HDMI cable.
 - On your TV, check that HDMI-CEC and HDMI ARC have been enabled. Refer to the owner's manual of your TV for more information.
2. Use an HDMI cable (V2.0 or later) to connect the soundbar with your digital device, such as a set-top box, DVD/Blu-ray player or game console.
 - On your digital device, check that HDMI-CEC has been enabled. Refer to the owner's manual of your digital device for more information.
 - On your digital device, select "Bitstream" or "Raw data" in the audio output settings for the best Dolby Atmos experience.

NOTES:

- To play audio from the digital device connected to the soundbar, select the **HDMI IN** source (See "7.3 Play from the HDMI IN source").
- If your TV does not support HDMI eARC, make sure that you connect your digital device through the **HDMI (1/ 2 / 3)** connector on the soundbar instead of your TV. Otherwise, the Dolby Atmos information cannot pass through the HDMI (ARC) connectors to the soundbar.

5.1.3 OPTICAL

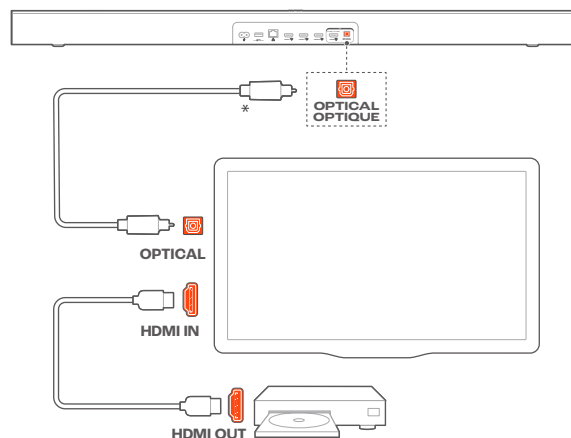

1. Connect the soundbar with your TV by using an optical cable.
2. Use an HDMI cable (V2.0 or later) to connect your TV with your digital device, such as a streaming device, set-top box, DVD/Blu-ray player or game console.

NOTE:

- To play audio through the optical cable, select the **TV** source (See "7.2 Play from the TV source").

5.2 Connect to your Bluetooth device

Through Bluetooth, connect the soundbar with your Bluetooth device, such as a smartphone, tablet and laptop.

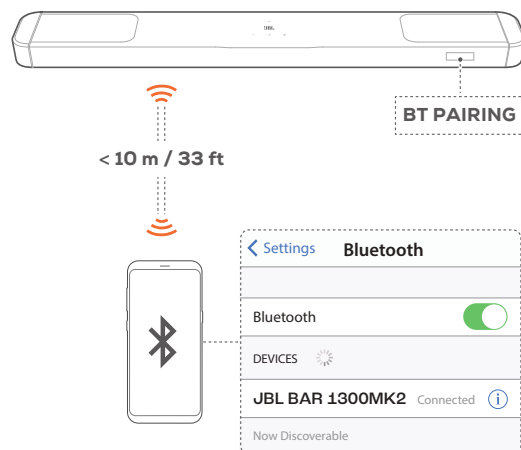

5.2.1 Connect a Bluetooth device

1. To select Bluetooth source, press **⏮** on the soundbar or **⏮** on the remote control.
 - **"BT PAIRING"**: Ready for Bluetooth pairing
2. On your Bluetooth device, enable Bluetooth and search for **"JBL BAR 1300MK2"** within three minutes.
 - **"BT CONNECTED"**: Successful connection. A confirmation tone is heard.

5.2.2 Reconnect the last paired device

Your Bluetooth device is retained as a paired device when the soundbar goes to standby mode. Next time you switch to the Bluetooth source, the soundbar reconnects the last paired device automatically.

5.2.3 Connect to another Bluetooth device

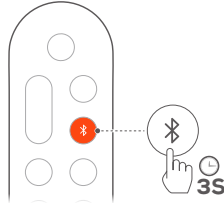

- In the Bluetooth source, hold **⏪** on the soundbar or **Ⓜ** on the remote control until **"BT PAIRING"** is displayed.
→ The soundbar enters the Bluetooth pairing mode.
- Follow the Step 2 under ["5.2.1 Connect a Bluetooth device"](#).
 - If the device has ever been paired with the soundbar, first unpair **"JBL BAR 1300MK2"** on the device.

NOTES:

- The Bluetooth connection will be lost if the distance between the soundbar and Bluetooth device exceeds 33 ft (10 m).
- Electronic devices may cause radio interference. Devices that generate electromagnetic waves must be kept away from the soundbar, such as microwaves and wireless LAN devices.

5.3 Connect to your home network

With the JBL One app and the supported streaming services (Google Cast, AirPlay, Spotify Connect, Tidal Connect and Roon Ready), the soundbar allows you to stream audio from smartphones or tablets.

5.3.1 Wi-Fi connection with your home network

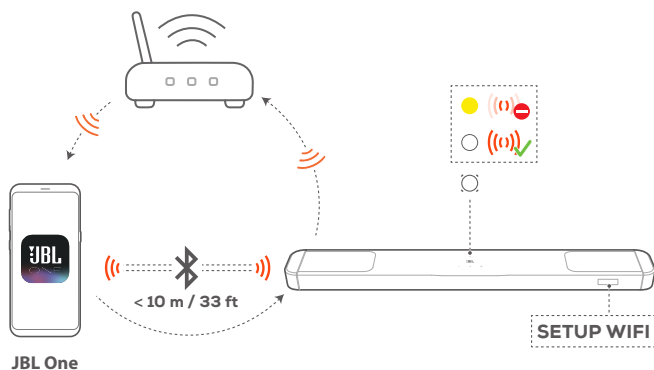

- On the soundbar, enter the Wi-Fi setup mode:
 - Press any button on the soundbar (See ["7.1 Switch on/ Auto standby/Auto wakeup"](#)).
→ If the soundbar has not been connected to a network, the screen shows **"HELLO"** and then, **"SETUP WIFI"**.
 - If your soundbar is not discovered by the JBL One app, hold **−** and **+** together for more than 10 seconds to re-enter the Wi-Fi setup mode.

- Connect your Android™ or iOS device to your home Wi-Fi network. Download the JBL One app.
- Launch the JBL One app. Follow the app instructions to complete Wi-Fi setup.

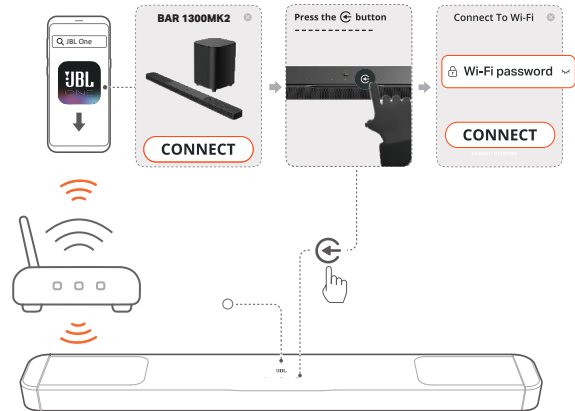

- (Solid white): The soundbar is connected to your home network.
- You can stream music from the JBL One app or the streaming services you have enabled in the JBL One app (See ["7.5 Play over your home network"](#)).

5.3.2 Wired connection with your home network (Optional)

- Use an Ethernet cable (not supplied) to connect the soundbar to your home network.

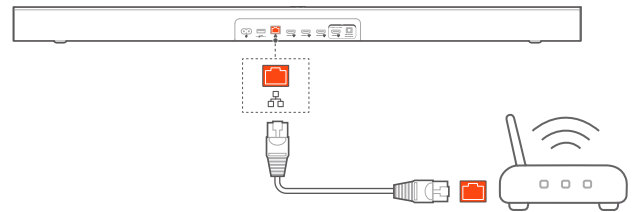

- On your Android or iOS device, download and launch the JBL One app for music streaming.

NOTES:

- On your Android or iOS device, you can rename the soundbar in the JBL One app.
- On your iOS device, add the soundbar to the Apple Home app and manage it together with other AirPlay-compatible speakers.
- On your iOS device, if the soundbar has been added to your home Wi-Fi network, you can start AirPlay streaming from an AirPlay-compatible app (See ["7.5.4 Play through AirPlay"](#)).
- Availability of online music streaming services varies by country.
- Some features require subscriptions or services not available in all countries.

6. SETUP

6.1 Connect the detachable rear speakers and subwoofer

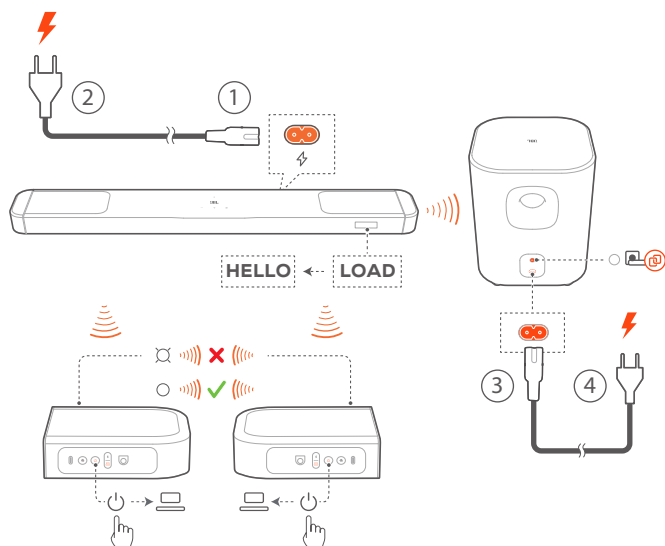

1. Connect the soundbar to power by using the supplied power cord.
 - The screen on the soundbar shows “LOAD” and then, “HELLO”.
2. Do the following to start the connection:
 - Connect the subwoofer to power by using the supplied power cord;
 - The soundbar connects the subwoofer automatically.
Connected: turns solid white on the subwoofer.
 - Dock the detachable speakers onto the soundbar, or press on the detachable speakers, then press on the detachable speakers to fast re-connect to the soundbar.
 - The soundbar connects the detachable speakers automatically.
Connected: The status indicator turns solid white on the detachable speakers.

NOTES:

- Use the supplied power cords only.
- Before connecting to power, make sure that you have completed all other connections (See “[5.1 Connect with your TV and digital devices](#)”).

6.2 Charge the detachable speakers

When the detachable surround speakers are out of battery, their wireless connection with the soundbar will be lost.

The first time you use the two detachable speakers, charge them for about 4 hours to ensure sufficient battery power.

- When the battery power runs low, the status indicator flashes red on the detachable surround speakers and “REAR SPKR LOW BATT” is displayed on the soundbar.

- When the battery power runs out, “DOCK REAR SPKR” is displayed on the soundbar.

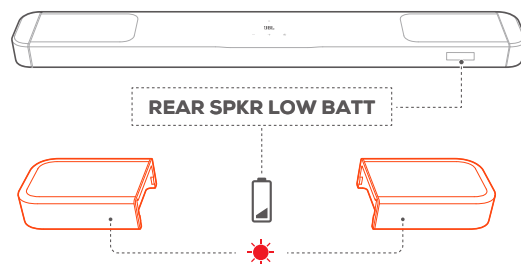

6.2.1 Charge by docking the detachable speakers

Charging starts when you dock the detachable speakers onto the soundbar.

- When the soundbar switches to standby mode, turns on; turns off when the detachable speakers are fully charged.
- It takes about 4 hours for the empty battery to be fully charged.

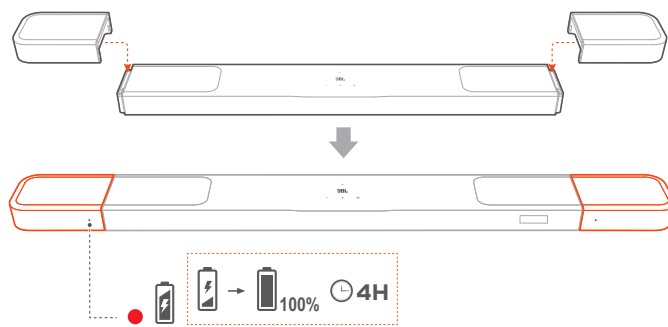

6.2.2 Charge through a USB cable

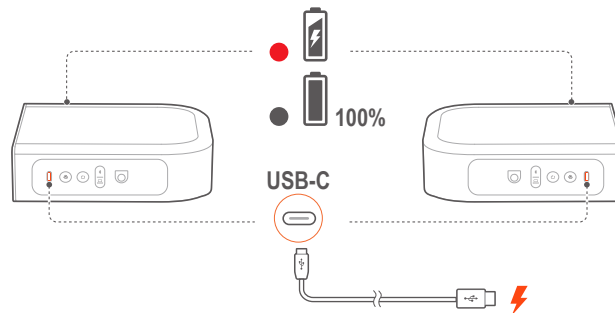

- Use a USB-C cable (sold separately) to connect the detachable speakers to power respectively.
- For the detachable speakers, the status indicator is used for status indication of both battery power and wireless connection (See “[3.2 Detachable speakers](#)”).

6.3 3D surround sound

6.3.1 Sound calibration

Optimize your 3D surround sound experience for your unique listening environment.

For sound calibration, make sure that:

- your room is quiet;
- the soundbar and the two detachable rear speakers are fully in sight of each other, without obstacles in between;
- the left and right rear speakers are properly placed, the **L** speaker on the left and the **R** speaker on the right.

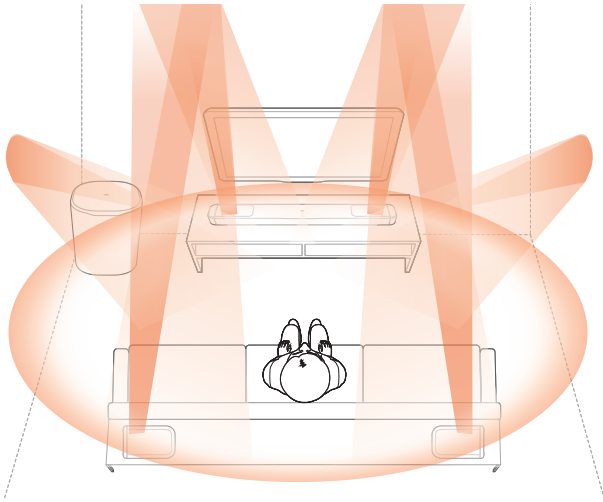

1) Calibrate the listening zone

1. Place the detachable rear speakers beside your seating position.

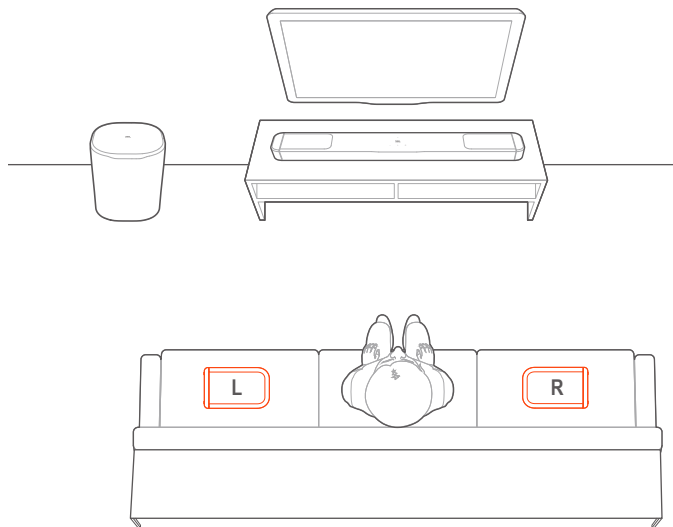

- Make sure that the two detachable speakers have been connected to the soundbar (See [“6.1 Connect the detachable rear speakers and subwoofer”](#)).

2. On the remote control, press  to start calibration.
→ **“1-CALIBRATION”** is displayed on the soundbar.

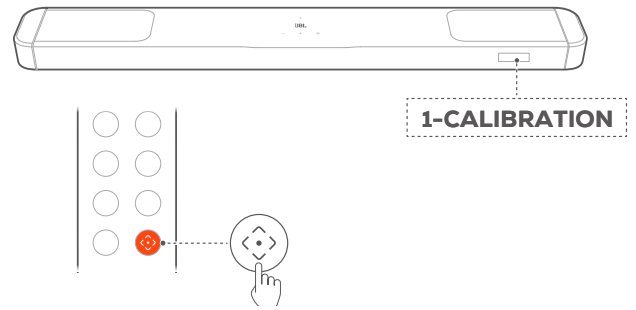

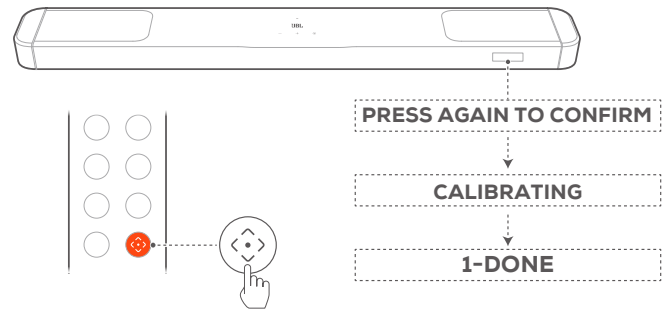

3. When **“PRESS AGAIN TO CONFIRM”** is displayed, press  again.
→ Countdown starts from 5 to 1.
→ Calibration tone is heard. Audio calibration starts.
“CALIBRATING”: Calibration in progress
“1-DONE”: Calibration of the listening zone is completed successfully.

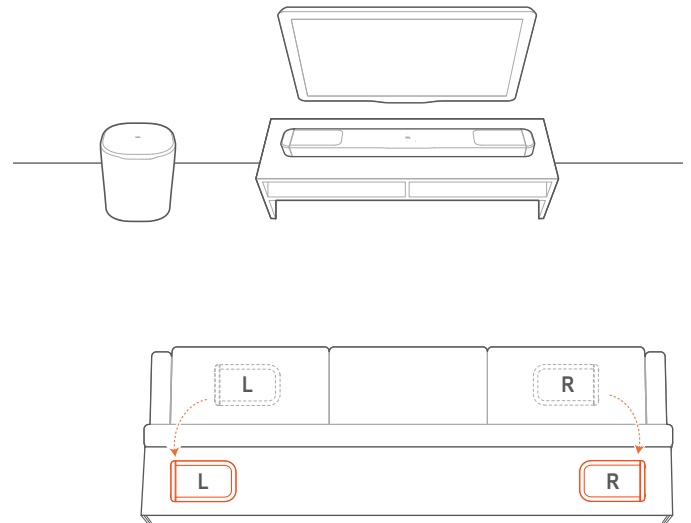

2) Calibrate the speaker position

1. Place the detachable rear speakers in your desired location.



2. On the remote control, press .
 - “2-CALIBRATION” is displayed on the soundbar.
 - Countdown starts from 5 to 1.
 - Calibration tone is heard. Audio calibration starts.
 - “CALIBRATING”: Calibration in progress
 - “2-DONE”: Calibration of the speaker position is completed successfully.

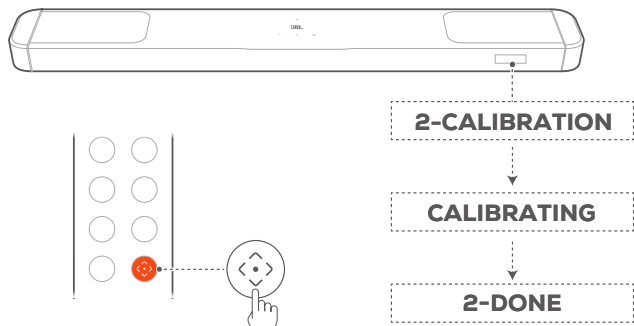



NOTE:

- During sound calibration, all buttons on the remote control are disabled except for  and .
- During sound calibration, environmental sound will be recorded. Hold  for 10 seconds, then press  to play the recorded audio (for US version only).

6.3.2 Dolby Atmos / DTS:X

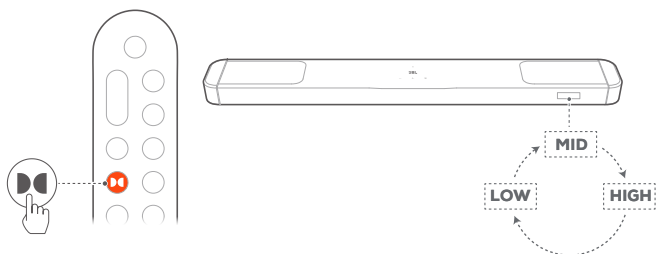
With Dolby Atmos or DTS:X, overhead audio distribution is provided for powerful 3D sound immersion.



1. To play the surround sound of Dolby Atmos or DTS:X, connect and play your Blu-ray player or streaming device as described under “[5.1 Connect with your TV and digital devices](#)”.
2. To adjust the sound level for Dolby Atmos or DTS:X, press  on remote control to toggle between middle (default), high, or low.

NOTE:

- Dolby Atmos and DTS:X sound effects are applicable only to their respective audio content.

6.3.3 Rear adjustment

With both of the detachable rear speakers undocked, you can select the surround sound level.

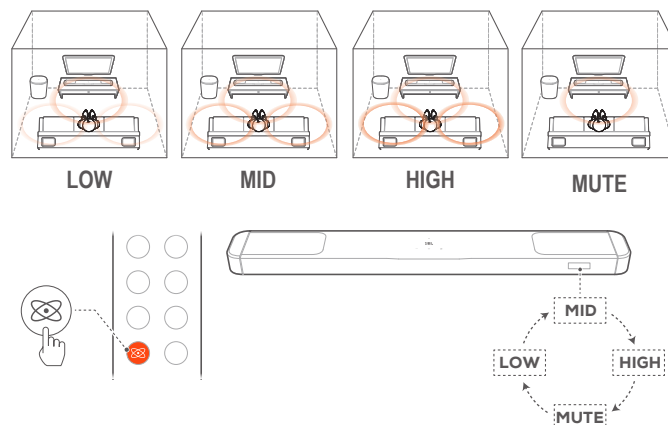

1. Check that the soundbar and the detachable rear speakers are connected wirelessly (See “[6.1 Connect the detachable rear speakers and subwoofer](#)”).
2. On the remote control, press  to toggle between surround sound levels.
 - “MID”/“HIGH”/“MUTE”/“LOW” is displayed (Default: “MID”).
 - “UNDOCK REAR SPKR” is displayed if the detachable rear speakers have been docked onto the soundbar.

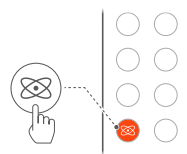
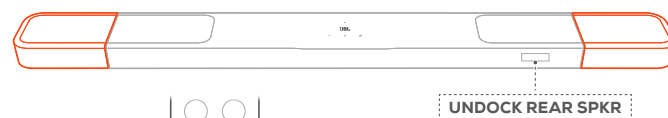

6.3.4 Bass adjustment

You can make bass adjustment as needed.

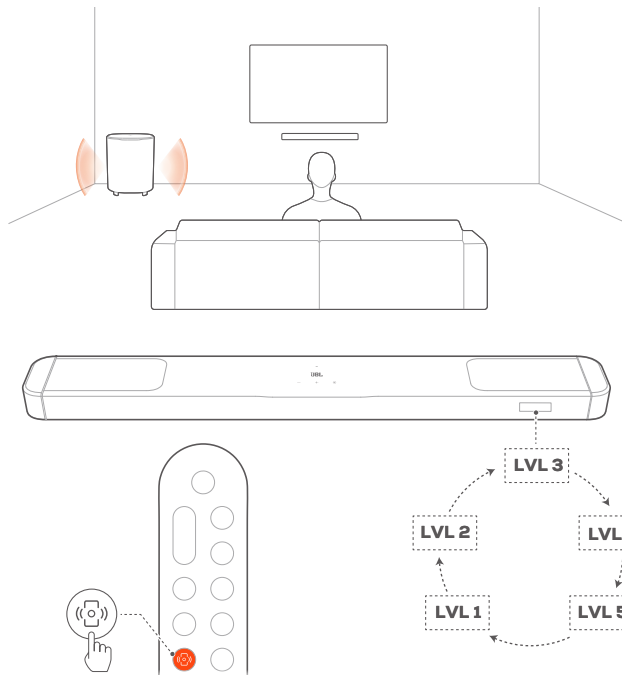

On the remote control, press to toggle between bass levels.
→ “LVL1” to “LVL5” is displayed (Default: “LVL3”).

6.4 Use the detachable speakers

With the detachable speakers, you can

- set up the rear speakers as standalone Bluetooth speakers or a Bluetooth stereo system.
- enable Audio Broadcasting or Night Listening to enhance your audio experience.

6.4.1 Standalone Bluetooth speakers

Either of the detachable rear speakers can be a standalone Bluetooth speaker.

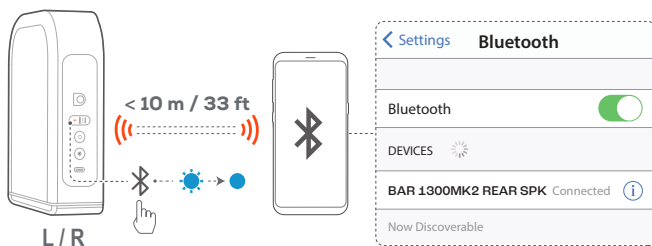

Connect a Bluetooth device

1. On the left or right speaker, press to switch to the Bluetooth mode.
→ : Ready for Bluetooth pairing
→ The detachable rear speaker disconnects from the soundbar.

2. On your Bluetooth device, enable Bluetooth and search for “BAR 1300MK2 REAR SPK” within three minutes.
→ : Successful connection
3. Start audio play on your Bluetooth device.

Reconnect the last paired device

Your Bluetooth device is retained as a paired device when the speaker goes to standby mode. Next time you switch to the Bluetooth mode, the speaker reconnects the last paired device automatically.

Connect to another Bluetooth device

1. In the Bluetooth mode, press on the left or right speaker.
→ : The speaker enters the Bluetooth pairing mode.
2. Follow the Step 2 under “[Connect a Bluetooth device](#)”.

6.4.2 Bluetooth stereo system

By connecting the two detachable speakers, you can set up a stereo music system with L (left) and R (right) channels.

1. Make sure that the left and right rear speakers are properly placed, the L speaker on the left and the R speaker on the right.
 2. Connect the two speakers:
 - a) On one speaker, hold until the status indicator flashes cyan.
 - b) Within three minutes, hold on the other speaker until the status indicator flashes cyan.
- : Ready for Bluetooth Stereo pairing
→ : Bluetooth Stereo connected

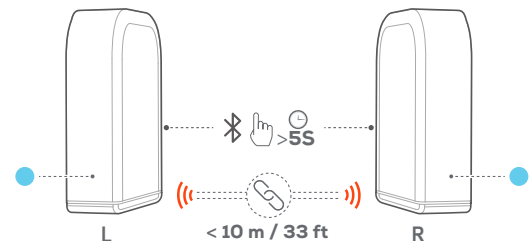

3. The two speakers start to play music from the device connected to the primary speaker.

To break the Bluetooth Stereo link between the two speakers

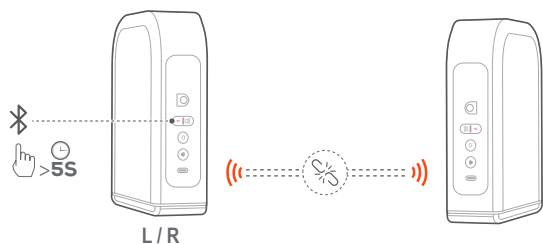

- On either of the connected speakers, hold until the status indicator flashes cyan.
 - : You break the Bluetooth Stereo link between the two speakers.
 - : The speakers switch to the Bluetooth pairing mode and reconnect the last paired Bluetooth device respectively.

NOTES:

- The Bluetooth connection will be lost if the distance between the soundbar and Bluetooth device exceeds 33 ft (10 m).
- Electronic devices may cause radio interference. Devices that generate electromagnetic waves must be kept away from the Soundbar, such as microwaves and wireless LAN devices.

6.4.3 Rear speaker audio settings

Using the JBL One app, while both rear speakers are undocked, you can:

- adjust the volume level of the rear speakers;
- check the battery status of the rear speakers;
- enable Audio Broadcasting to adjust the audio settings of the rear speakers to your preference;
- enable Night Listening to create a quiet listening environment at night.

Audio Broadcasting

- In the JBL One app, enable Audio Broadcasting and select your preferred audio settings: Mono or Stereo.

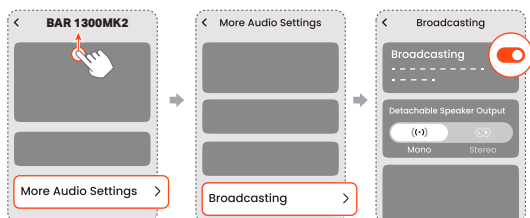

- When the Mono audio channel is selected, **“MONO BROADCASTING”** is displayed on the soundbar.
- When the Stereo audio channel is selected, **“STEREO BROADCASTING”** is displayed on the soundbar.

- Undock one or both rear speakers from the soundbar, and then move the rear speaker(s) to your desired locations.

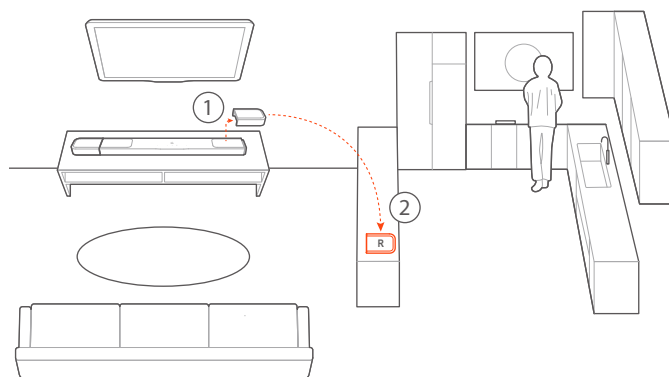

→ You can enjoy audio from the soundbar at the living room and audio from the rear speakers in the kitchen or other areas of the room.

Night Listening

- In the JBL One app, enable Night Listening.

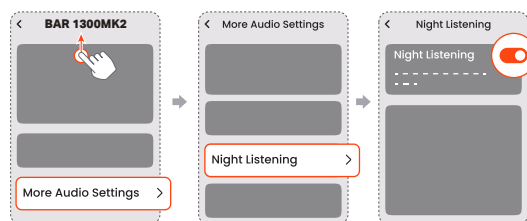

- Undock the rear speakers from the soundbar, and then move the rear speakers close to you.

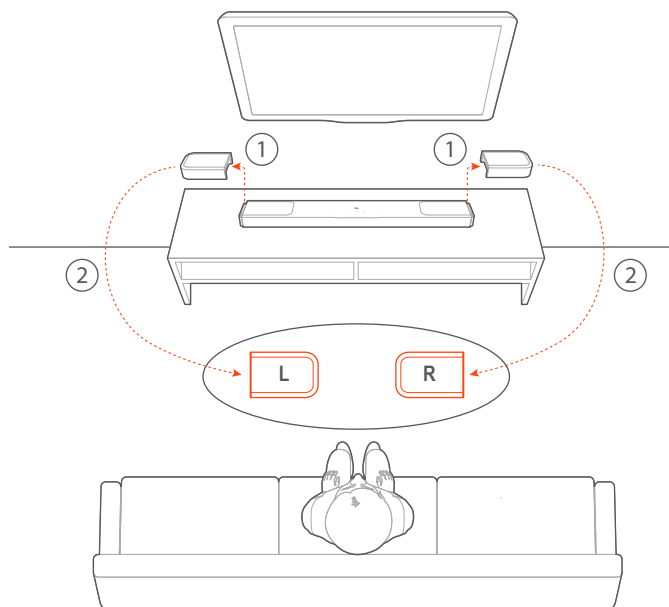

→ The soundbar and subwoofer are muted. You can enjoy audio at night without disturbing others.

7. PLAY

7.1 Switch on/Auto standby/Auto wakeup

7.1.1 Switch on

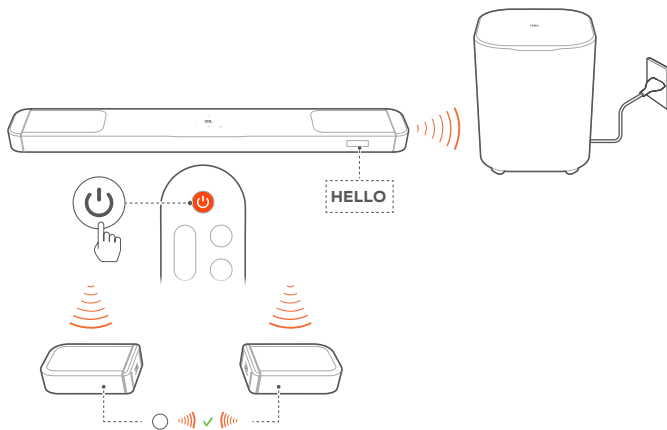

To switch on, press on the remote control, or press any button on the soundbar to wake up the system.

- “HELLO” is displayed.
- The subwoofer is reconnected to the soundbar automatically. **Connected:** turns solid white.
- The detachable speakers are reconnected to the soundbar automatically. **Connected:** The status indicator turns solid white (○).

7.1.2 Auto standby

If the soundbar is inactive for more than 10 minutes, it will switch to standby mode automatically. “STDBY” is displayed.

- The subwoofer also goes to standby, and turns solid amber.
- The detachable speakers switch to standby, and the status indicator turns off for wireless connection status.
- Next time you switch on the soundbar, it returns to the last selected source.

NOTE:

- On the detachable speakers, hold for more than 3 seconds to switch off. To reconnect to the soundbar, press again and then, if necessary, press to switch to the soundbar mode.

7.1.3 Auto wakeup

In standby mode, the soundbar will wake up automatically when

- the soundbar is connected to your TV through the HDMI eARC/ARC connection and your TV is switched on;
- the soundbar is connected to your TV and digital device such as a set-top box, DVD / Blu-ray player or game console through HDMI cables, and your digital device is switched on;
- the soundbar is connected to your home network and audio is streamed to the soundbar through the music streaming services.

7.2 Play from the TV source

With the soundbar connected, you can enjoy TV audio from the soundbar speakers.

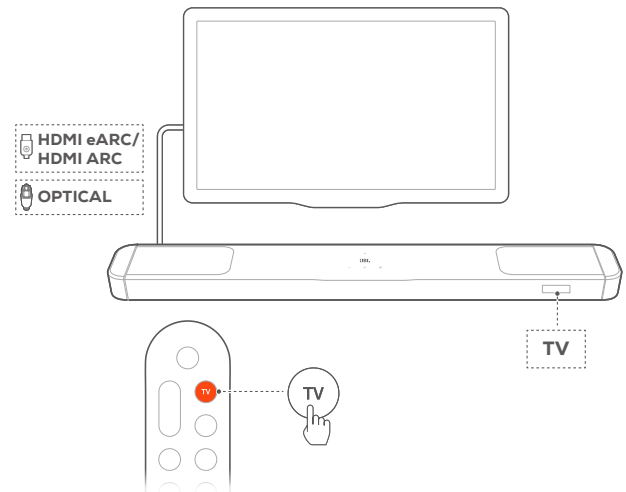

1. Make sure that your TV is set to support external speakers and the built-in TV speakers are muted. Refer to the owner's manual of your TV for more information.
2. Make sure that the soundbar has been properly connected to your TV (See [“5.1 Connect with your TV and digital devices”](#)).
3. To select the TV source, press on the soundbar or TV on the remote control.
 - “TV”: The TV source is selected.
 - In the factory settings, the TV source is selected by default.

NOTE:

- If the soundbar is connected to your TV through both an HDMI cable and an optical cable, the HDMI cable source is selected for the TV connection.

7.2.1 TV remote control setup

To use your TV remote control for both your TV and the soundbar, check that your TV supports HDMI-CEC. If your TV does not support HDMI-CEC, follow the steps under [“TV remote control IR learning”](#).

HDMI-CEC

If your TV supports HDMI-CEC, enable the functions as instructed in your TV user manual. You can control the “volume +/-, mute/unmute, and power on/standby” functions on your soundbar through the TV remote control.

TV remote control IR learning

Through IR learning, you can program the soundbar to accept IR commands from your TV remote control, and then use your TV remote control for simple commands.

1. On the soundbar, hold and until “LEARNING” is displayed.
 - The soundbar enters the TV remote control learning mode.

2. Point your TV remote control at the soundbar. Follow the screen instructions to operate the buttons on your TV remote control:

- When any one of **“POWER”**, **“VOL+”**, **“VOL-”**, or **“MUTE”** is displayed on the soundbar, press the desired button on your TV remote control.
 - **“DONE”**: These commands are learned by the soundbar.
 - The soundbar returns to the last selected source.
- To exit the TV remote control learning mode, hold **⏪** and **+** on the soundbar until **“EXIT LEARNING”** is displayed.
 - The learnt functions are discarded.

NOTE:

- The soundbar will exit the TV remote control learning mode automatically if no action is taken for 30 seconds. The learnt functions are discarded.

7.3 Play from the HDMI IN source

With the soundbar connected as shown, your digital device can play video on your TV and audio from the soundbar speakers.

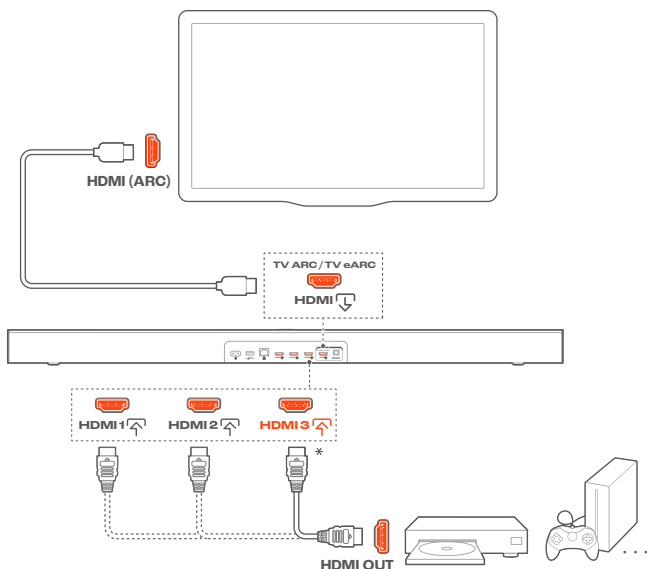

1. Make sure that the soundbar has been properly connected to your TV and digital device (See [“5.1 Connect with your TV and digital devices”](#)).
2. Switch on your digital device.
 - Your TV and the soundbar wake up from standby mode and switch to the input source automatically.
 - To select the **HDMI IN** source on the soundbar, press **⏪** on the soundbar or **HDMI** on the remote control.

NOTE:

- Full compatibility with all HDMI-CEC devices is not guaranteed.

7.4 Play from the Bluetooth source

Through Bluetooth, stream audio play on your Bluetooth device to the soundbar.

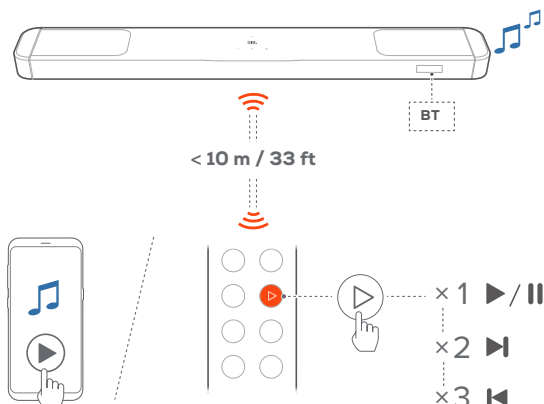

1. To select the Bluetooth source, press **⏪** on the soundbar or **⏪** on the remote control.
2. Check that the soundbar has been properly connected to your Bluetooth device (See [“5.2 Connect to your Bluetooth device”](#)).
3. Start audio play on your Bluetooth device.
 - Alternatively, press **▶** on the remote control to control playback.
4. Adjust the volume on the soundbar, remote control or your Bluetooth device.

To use the detachable speakers as standalone Bluetooth speakers or Bluetooth stereo system

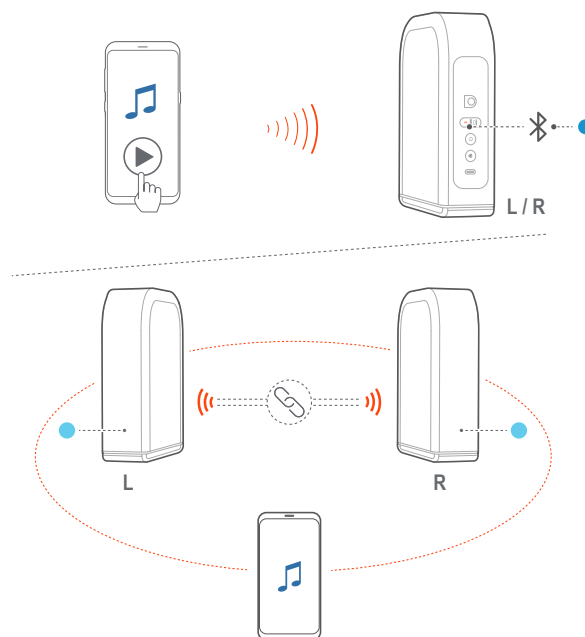

See [“6.4 Use the detachable speakers”](#) for the information about setup and playback.

7.5 Play over your home network

NOTES:

- The soundbar can support audio streaming, but not video streaming.
- During Wi-Fi music streaming, music playback will pause on the currently connected device when you start music playback on a second connected device.
- When the soundbar switches between your home Wi-Fi and wired network during AirPlay, music playback will pause and resume in a few minutes, depending on broadband bandwidth conditions. For the connection to your home wired network, see "[5.3 Connect to your home network](#)".

Before you start, make sure that:

- your Android or iOS device is connected to the same Wi-Fi network as your soundbar (See "[5.3 Connect to your home network](#)").

7.5.1 Play with Google Cast

With Google Cast, stream audio on your Android or iOS device to the soundbar.

On your Android or iOS device:

1. Launch the JBL One app, and check that you have enabled Google Cast.

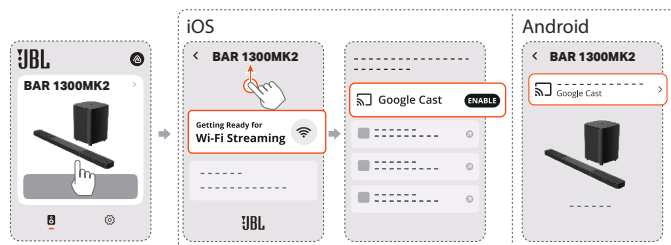

2. On a Google Cast-enabled app, play music, tap the cast icon  and select the connected soundbar.



7.5.2 Play through Spotify Connect

Through Spotify Connect, stream audio from your Android or iOS device to the soundbar.

NOTE:

- Subscription is required for Spotify Connect.

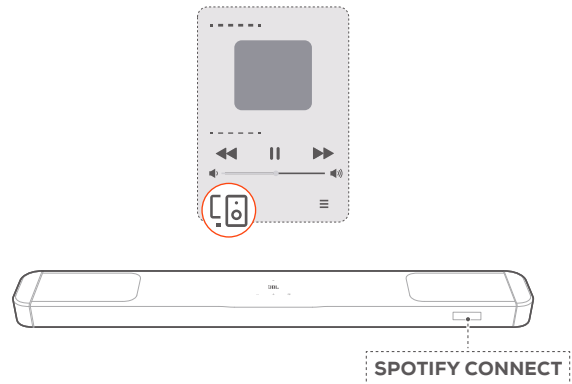

On your Android or iOS device:

1. Launch the Spotify app and select a song to play.
2. Tap the speaker icon  in the bottom corner of your screen.
3. Select the connected soundbar from the device list, and then start audio streaming.

7.5.3 Play through Tidal Connect

Through Tidal Connect, stream audio from your Android or iOS device to the soundbar.

NOTE:

- Subscription is required for Tidal Connect.

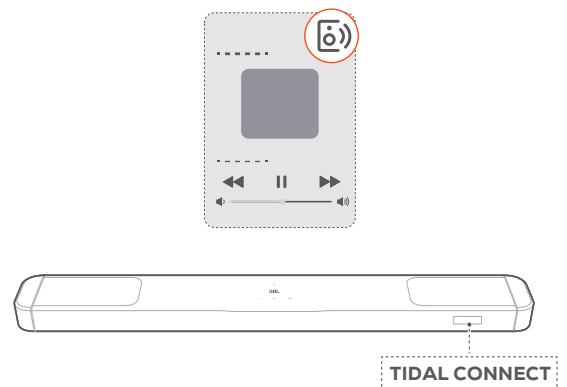

On your Android or iOS device:

1. Launch the Tidal app and select a song to play.
2. Tap on the device selector  at the top right of the screen.
3. Select the connected soundbar from the device list, and then start audio streaming.

7.5.4 Play through AirPlay

Through AirPlay, stream audio on your iOS device to the soundbar.

On your iOS device:

1. Swipe down from the upper right corner to enter the Control Center.
2. Tap  to select the connected soundbar and then start audio streaming from an app.

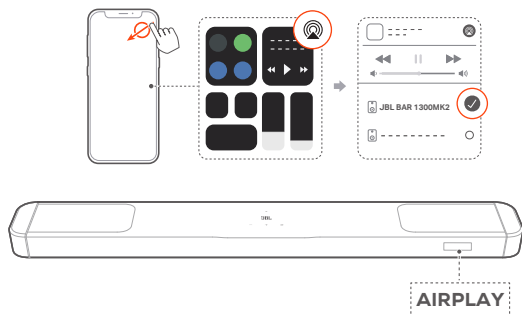

7.5.5 Play through the JBL One app

Through the JBL One app, stream audio from enabled music services to the soundbar.

On your Android or iOS device,

- Launch the JBL One app, browse available *music streaming services to select music, and then, start music streaming to the connected soundbar.

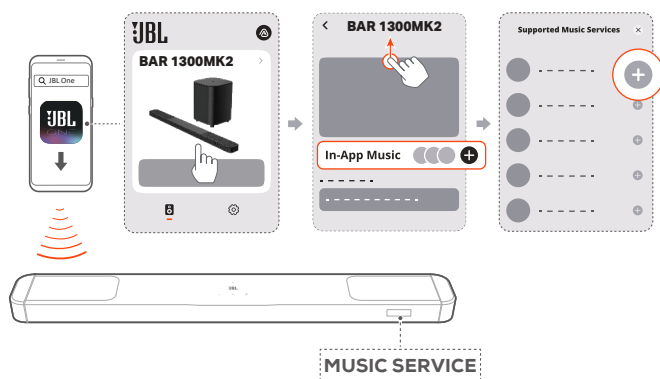



NOTE:

- *Subscription may be needed and not provided by the JBL One app.

Access your presets with the (Moment) button

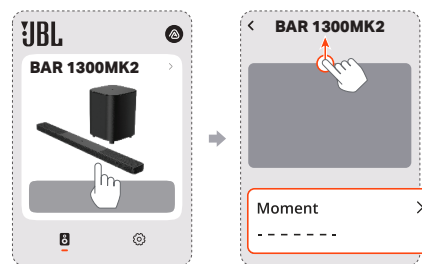
1. In the JBL One app,
 - Personalize the  (Moment) feature, and set your own playlist.



2. On the soundbar,
 - Press  on the remote control to directly access your music playlist and speaker settings that you have personalized in the JBL One app.

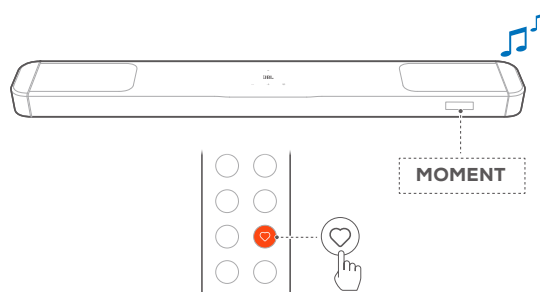

7.6 Multi-room playback

With the multi-room playback, you can stream music on your Android or iOS device to multiple Google Cast / AirPlay-enabled speakers.

7.6.1 Google Cast

1. Through the Google Home app, connect multiple Google Cast-enabled speakers to the same network, assign them to multiple rooms, and create groups as needed.
2. Run a Google Cast-enabled app on your smartphone or tablet.
3. Play music. Press  and select the grouped speakers.

NOTES:

- To create a multi-room speaker group in the Google Home app, make sure that you have connected all the speakers to the same home network and have used the same Google login account. Refer to the Google Home app for more details.
- Depending on the bandwidth of your local network, you can stream music to up to 6 Google Cast-enabled speakers.

7.6.2 AirPlay

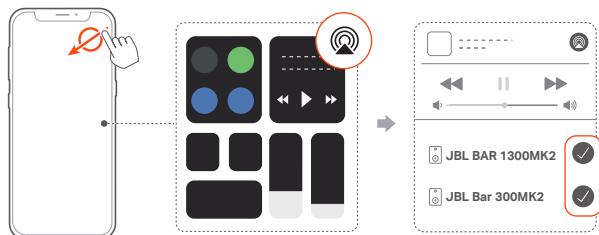

1. On an iOS device, enter the Control Center.
2. Tap  to select multiple connected speakers as needed.
3. Start music streaming from an app.

8. ADVANCED USAGE

8.1 Audio sync

With the audio sync function, you can synchronize audio and video to make sure that no delay is heard from your video content.

1. On the remote control, hold **TV** for more than 3 seconds and then press **+**.
→ “**SYNC**” is displayed.
2. Within 5 seconds, press **+** or **-** on the remote control to adjust the audio delay and match with video.
→ The audio sync timing is displayed.

NOTE:

- You can also adjust the audio delay through the JBL One app.

8.2 Multi-speaker connection (Detachable speakers)

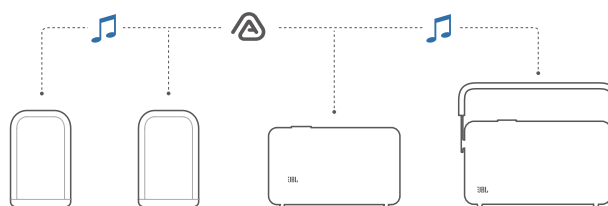

You can connect multiple JBL speakers via Auracast to create a party atmosphere with enhanced sound.

9. RESTORE FACTORY SETTINGS

To restore the factory settings, hold **C**, **+** and **-** for more than 5 seconds.

→ **“RESET”** is displayed.

→ When the factory reset is complete, the soundbar will automatically restart.

10. SOFTWARE UPDATE



Connect the soundbar to your home network. Online updates will be performed automatically when software updates are available.

→ **“WAIT”**: Software updating in progress

→ **“DONE”**: Software updating completed

NOTE:



- Software updates will be synchronized to the two detachable speakers when they are connected to or docked onto the soundbar.

11. RE-CONNECT THE SUBWOOFER

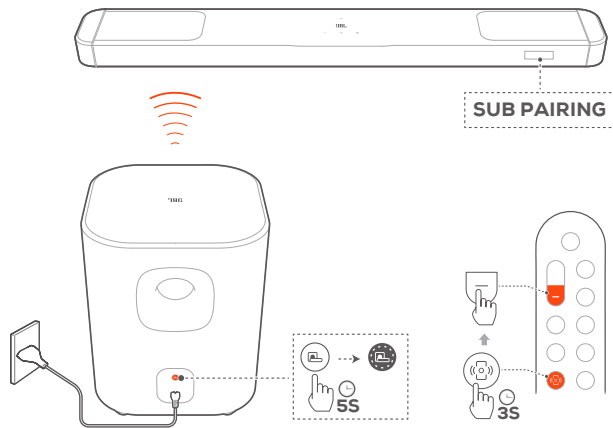

The soundbar and subwoofer are paired at factories. After power-on, they are paired and connected automatically. In some special cases, you may need to pair them again.



To re-enter the subwoofer pairing mode

1. On the rear panel of the subwoofer, hold  until it turns fast flashing white.
2. To enter the subwoofer pairing mode on the soundbar, hold  on the remote control for more than 3 seconds, and then press  on the remote control.
 - “SUB PAIRING”: The subwoofer is ready for pairing.
 - “SUB PAIRED”: The subwoofer is connected.

NOTE:

- If pairing is not completed within 3 minutes, the subwoofer will exit pairing mode and enter standby.  turns from fast flashing white to off. To return to the pairing mode, press .

12. PRODUCT SPECIFICATIONS

General specification

- Model: BAR 1300XMK2 (soundbar unit)
BAR 1300XMK2 SURROUND (detachable speaker)
BAR 1300XMK2 SUB (subwoofer unit)
- Sound system: 11.1.4 channel
- Power supply: 100 - 240 V AC, ~ 50/60 Hz
- Total speaker power output* (Max. @THD 1%): 1570 W
- Soundbar output power** (Max. @THD 1%): 950 W
- Surround speaker output power*** (Max. @THD 1%): 2 x 160 W
- Subwoofer output power**** (Max. @THD 1%): 300 W
- Soundbar transducer: 8 x (50 x 75 mm) racetrack drivers, 7 x 1" (25 mm) tweeters, 4 x 3" (75 mm) up-firing full-range drivers
- Surround speaker transducer: 2 x (50 x 90 mm) racetrack drivers, 1 x 2" (50 mm) full-range drivers, 1 x 3" (75 mm) up-firing full-range drivers
- Subwoofer transducer: 12" (311 mm)
- Networked standby power: < 2 W
- Operating temperature: 0 °C - 45 °C
- Lithium battery: 7.2 V, 4722 mAh
- Detachable surround speaker playtime: up to 10 hours (may vary according to content type and volume level)

HDMI specification

- HDMI video input: 3
- HDMI video output (with Enhanced Audio Return Channel, eARC): 1
- HDMI HDCP version: 2.3
- HDR pass through: HDR10+, Dolby Vision

Audio specification

- Frequency response: 33 Hz - 20 kHz (-6 dB)
- Audio inputs: Optical, Bluetooth, USB (USB playback is available in US and APAC version. For other versions, USB is for Service only.)

USB specification

- USB port: Type A
- USB rating: 5 V DC, 0.5 A
- Supporting file formats: mp3
- MP3 codec: MPEG 1 Layer 2/3, MPEG 2 Layer 3, MPEG 2.5 Layer 3
- MP3 sampling rate: 16 - 48 kHz
- MP3 bitrate: 80 - 320 kbps

Wireless specification

- Bluetooth version: Main Bar - v5.3, Detachable surround speaker - v5.4
- Main bar Bluetooth profile: A2DP v1.3, AVRCP v1.5
- Detachable surround speaker Bluetooth profile: A2DP v1.4, AVRCP v1.6
- Bluetooth transmitter frequency range: 2400 MHz - 2483.5 MHz
- Bluetooth transmitter power: <15 dBm (EIRP)

- Wi-Fi network: IEEE 802.11 a/b/g/n/ac/ax (2.4 GHz / 5 GHz)
- 2.4G Wi-Fi transmitter frequency range: 2412 - 2472 MHz (2.4 GHz ISM Band, USA 11 Channels, Europe and others 13 Channels)
- 2.4G Wi-Fi transmitter power: < 20 dBm (EIRP)
- 5G Wi-Fi transmitter frequency range: 5.15 - 5.35 GHz, 5.470 - 5.725 GHz, 5.725 - 5.825 GHz
- 5G Wi-Fi transmitter power: 5.15 - 5.25 GHz <23 dBm, 5.25 - 5.35 GHz & 5.470 - 5.725 GHz <20 dBm, 5.725 - 5.825 GHz <14 dBm (EIRP)
- 5G wireless transmitter frequency range: 5.15 - 5.35 GHz, 5.470 - 5.725 GHz, 5.725 - 5.825 GHz
- 5G wireless transmitter power: 5.15 - 5.25 GHz <23 dBm (EIRP), 5.25 - 5.35 GHz & 5.470 - 5.725 GHz <20 dBm (EIRP), 5.725 - 5.825 GHz <14 dBm (EIRP)

Dimensions

- Total soundbar dimensions (W x H x D): 1404 x 58 x 136 mm / 55.3" x 2.3" x 5.4"
- Soundbar dimensions (W x H x D): 1030 x 58 x 136 mm / 40.6" x 2.3" x 5.4"
- Detachable surround speaker dimensions (each) (W x H x D): 202 x 58 x 136 mm / 8" x 2.3" x 5.4"
- Subwoofer dimensions (W x H x D): 380 x 482.5 x 380 mm / 15" x 19" x 15"
- Soundbar weight: 5.93 kg / 13 lbs
- Detachable surround speaker weight (each): 1.3 kg / 2.8 lbs
- Subwoofer weight: 15.4 kg / 34 lbs
- Packaging dimensions (W x H x D): 1124 x 463 x 565 mm / 44.3" x 18.2" x 22.2"
- Packaging weight: 29.3 kg / 64.6 lbs

* RMS @THD 1%: 785 W

** RMS @THD 1%: 475 W

*** RMS @THD 1%: 2 x 80 W

**** RMS @THD 1%: 150 W

13. TROUBLESHOOTING

Never try to repair the product yourself. If you have problems using this product, check the following points before you request services.

System

The unit will not turn on.

- Check if the power cord is plugged into power and the soundbar.

The soundbar has no response to button pressing.

- Restore the soundbar to factory settings (See "[9. RESTORE FACTORY SETTINGS](#)").

Sound

No sound from soundbar

- Make sure that the soundbar is not muted.
- Select the correct audio input source on the remote control.
- Connect the soundbar to your TV or other devices properly
- Restore the soundbar to factory settings (See "[9. RESTORE FACTORY SETTINGS](#)").

Distorted sound or echo

- If you play audio from your TV through the soundbar, make sure that your TV is muted or the built-in TV speaker is disabled.

Audio and video are not synchronized.

- Enable the audio sync function to synchronize audio and video (See "[8.1 Audio sync](#)").

No height sound effects of Dolby Atmos

- If your TV supports HDMI ARC only, make sure that you have connected your digital device to the soundbar through the **HDMI (1/2/3)**  connector on the soundbar (See "[5.1.2 TV \(HDMI ARC\)](#)")
- Enjoy the sound effects of Dolby Atmos when you play movies from the TV / HDMI source. For audio streaming over Bluetooth or casting apps (enabled by Google Cast or AirPlay), Dolby Atmos is not supported.

Bluetooth

A device cannot be connected with the soundbar.

- Check if you have enabled Bluetooth on the device.
- If the soundbar has been paired with another Bluetooth device, reset Bluetooth (see "[5.2.3 Connect to another Bluetooth device](#)").
- If your Bluetooth device has ever been paired with the soundbar, reset Bluetooth on the soundbar, unpair the soundbar on the Bluetooth device, and then pair the Bluetooth device with the soundbar again (see "[5.2.3 Connect to another Bluetooth device](#)").

Poor audio quality from a connected Bluetooth device

- The Bluetooth reception is poor. Move the source device closer to the soundbar, or remove any obstacle between the source device and the soundbar.

The connected Bluetooth device connects and disconnects constantly.

- The Bluetooth reception is poor. Move the source device closer to the soundbar, or remove any obstacle between the source device and the soundbar.

Wi-Fi

Failed to connect to Wi-Fi.

- Make sure that Wi-Fi is turned on.
- Make sure that you have selected the right network and entered the correct password.
- Make sure that your router or modem is turned on and within the range.
- In your router settings, make sure that you have set the security type to WPA2 or auto.
- Make sure that your soundbar is connected to the same wireless LAN as your smartphone or tablet.
- If you have difficulties in setting up Wi-Fi, re-enter the Wi-Fi setup mode by holding **+** and **-** on the soundbar until **"SETUP WIFI"** is displayed.

Playback

AirPlay cannot find the soundbar as an AirPlay speaker for music streaming.

- On your Apple device, update the software to the latest version: iOS 13.4 and later, Mac OS 10.15.4 and later, or TV OS 14.3.
- Make sure that your Apple device has been connected to the same network as the soundbar.
- For a PC running iTunes for Windows, you can stream music from your PC to the soundbar through Bluetooth.

Music playback does not work smoothly when the sound source switches from Bluetooth to Google Cast or AirPlay.

- The quality of audio casting and playback are dependent on the traffic and coverage of the network that connects the soundbar and your casting devices, such as phones, tablets and PCs.

Music playback does not resume when the sound source switches from Bluetooth to TV / HDMI IN, and then back to Bluetooth.

- The music playback in the Bluetooth device stops when the sound source switches from Bluetooth to TV / HDMI IN. When you switch back to the Bluetooth source, start music playback in the Bluetooth device again.

Remote control

The remote control does not work.

- Check if the batteries are drained. If so, replace them with new ones.
- Reduce the distance and angle between the remote control and the main unit.

Failed to complete the TV remote control learning.

- Check if you are using an infra-red TV remote control. The IR learning is not supported by a Bluetooth TV remote control.

Low power standby mode

Failed to enter the low power standby mode

- To enter the low power standby mode, when the detachable speakers are docked on the soundbar, hold **⏻** on the remote control for 10 seconds until **"CEC 1"** is displayed on the soundbar. Next, hold **⏻** for another 10 seconds until **"CEC 2"** is displayed. After entering the **"CEC 2"** mode, the soundbar will switch to the standby mode while continuing to charge the detachable speakers. When the detachable speakers are fully charged after about 4 hours, the soundbar will automatically switch to the low power standby mode and stop charging the detachable speakers.
- To exit the low power standby mode, unplug the power cord and then plug it again.

14. TRADEMARKS



The Bluetooth® word mark and logos are registered trademarks owned by Bluetooth SIG, Inc. and any use of such marks by HARMAN International Industries, Incorporated is under license. Other trademarks and trade names are those of their respective owners.



The terms HDMI, HDMI High-Definition Multimedia Interface, HDMI trade dress and the HDMI Logos are trademarks or registered trademarks of HDMI Licensing Administrator, Inc.



The Wi-Fi CERTIFIED™ Logo is a registered trademark of Wi-Fi Alliance®.

COMPATIBLE WITH



Dolby, Dolby Vision, Dolby Atmos, and the double-D symbol are registered trademarks of Dolby Laboratories Licensing Corporation. Manufactured under license from Dolby Laboratories. Confidential unpublished works. Copyright © 2012–2024 Dolby Laboratories. All rights reserved.



FOR DTS PATENTS, SEE [HTTP://XPERI.COM/DTS-PATENTS/](http://xperi.com/dts-patents/). MANUFACTURED UNDER LICENSE FROM DTS, INC. AND ITS AFFILIATES. DTS, DTS:X, AND THE DTS:X LOGO ARE REGISTERED TRADEMARKS OR TRADEMARKS OF DTS, INC. AND ITS AFFILIATES IN THE UNITED STATES AND/OR OTHER COUNTRIES. © DTS, INC. AND ITS AFFILIATES. ALL RIGHTS RESERVED.



Google, Android, Google Home, Google Cast and other marks are trademarks of Google LLC.

Google Assistant is not available in certain languages and countries. Availability and performance of certain features, services, and applications are device and network dependent and may not be available in all areas.



Use of the Works with Apple badge means that an accessory has been designed to work specifically with the technology identified in the badge and has been certified by the developer to meet Apple performance standards.

Apple®, and AirPlay® are trademarks of Apple Inc., registered in the U.S. and other countries and regions.

To use AirPlay with JBL Bar 1300XMK2, the latest version of iOS, iPadOS, or macOS is recommended.



Use your phone, tablet or computer as a remote control for Spotify. Go to spotify.com/connect to learn how.

The Spotify Software is subject to third party licenses found here: <https://www.spotify.com/connect/third-party-licenses>.

ROON READY

Being Roon Ready means that HARMAN uses Roon streaming technology, for an incredible user interface, simple setup, rock-solid daily reliability, and the highest levels of audio performance, without compromise.

15. OPEN SOURCE LICENSE NOTICE

This product contains open source software licensed under GPL. For your convenience, the source code and relevant build instructions are also available at https://harman-webpages.s3.amazonaws.com/Harman_One_OS_D_package_license_list.htm

Please feel free to contact us at:

Harman Deutschland GmbH

HATT: Open Source, Gregor Krapf-Gunther,

Parkring 3 85748 Garching bei Munchen, Germany

or OpenSourceSupport@Harman.com if you have additional question regarding the open source software in the product.



HARMAN International Industries,
Incorporated 8500 Balboa Boulevard,
Northridge, CA 91329 USA
www.jbl.com

© 2025 HARMAN International Industries, Incorporated.

All rights reserved.

JBL is a trademark of HARMAN International Industries, Incorporated, registered in the United States and/or other countries. Features, specifications and appearance are subject to change without notice.