

CRS4K

The CRS Family of Amplifiers brings unparalleled flexibility into a traditional rack amp form factor. CRS amplifiers offer unbalanced/balanced analog and AES67 digital inputs while offering Phoenix-style outputs that can be used with traditional wiring or CC cables via adapters. These 1U-sized amps also allow for Direct Drive or 70v operation, multi-channel and multi-zone operation, full DSP control, and a myriad of other flexible features.

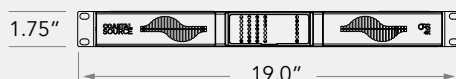
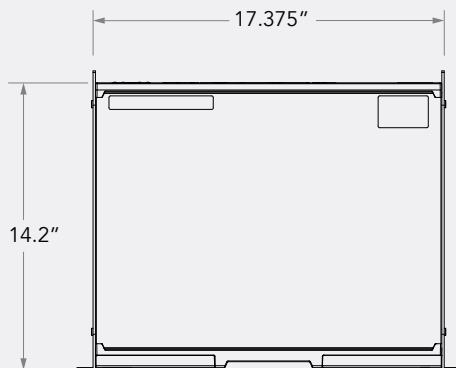
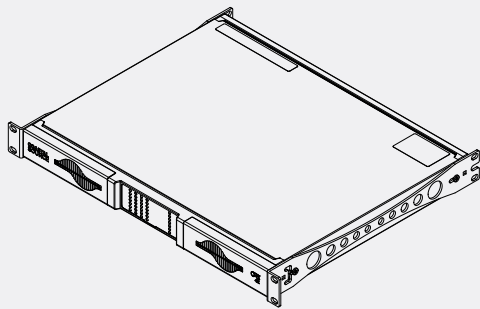

CRS AMPLIFIER SPECIFICATIONS

Size (L x H x W): 19.0" x 1.75" x 14.2"

Weight: 15.40 lbs

Construction: Powder Coated Steel

Max Speakers: Up to 4x 8 ohm speakers per channel
and up to 8x 8 ohm sub total

Frequency Response at 8 ohms: 20Hz-20kHz +/- 0.5 dB

Idle Power: 31W

Power In: 120VAC

Power Out: 4000W (1000W/CH x 4)

Impedance: Stable to 2 ohms

Mounting: Rack Mount

Channels: 4

Inputs: 4x Analog (Phoenix Connector) or AES67 (digital)

Outputs: Bare Wire (Phoenix Connector) or Female CC
(via adapters)

ORDERING INFORMATION

AMP	POWER
CRS	4K (4000W)

CRS — 4K e.g. CRS4K = CRS4K Amplifier

COMPATIBLE PRODUCTS

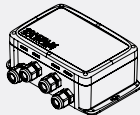
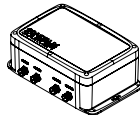
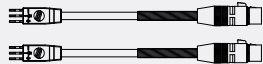
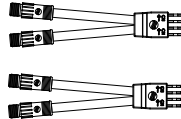
SKU	ITEM	
JBX-PT	JBX CC Pass-through Box	
JBX-C	JBX CC Converter Box	
CRSXLRICA-PR	CRS XLR Input Pigtails	
CRSCCOCA-PR	CRS CC Output Cable Adapters	
Cxx12/2WT	White 12AWG CC Extension Cables	