

CB465UI



Product family	Refrigerator
Installation	Built-in
Category	Bottom mount
No-frost system	Total
Cooling type	Total no-frost - Dual-flow cooling system
Defrost	Automatic
Hinge	Door-to-door
Kitchen panel	Not supplied
Hinge position	Right
Reversible door	Yes
EAN code	8017709313739



Aesthetic

Aesthetics	Universal	Glass shelf profile color	White
Handle	Not included	Display	TFT
Side material	Steel	Display position	Internal (belt-line)
Logo	Silkscreened	Dispenser	Ice and water
Door shelf profile color	Silver	Water filter	Internal
Drawers profile color	Silver		

Refrigerator compartment features



No. of adjustable shelves	2	Type of crisper cover	Glass
Number of fruit and vegetables drawers	1	No. of lights	3
Type of adjustable shelves	Glass	Convertible temperature drawer	Yes
Crisper drawer type	Standard	Refrigerator lighting	Yes
Crisper cover	Yes	Refrigerator lighting	LED

Refrigerator Inner Door

Number of adjustable door shelves	2	No. of bottle shelves	1
--	---	------------------------------	---

Other Refrigerator features



MultiFlow Yes

Freezer features

Number of drawers 1

Other Freezer features



Ice maker	Automatic	Ice-tray shelf	Yes
Fast-freezing compartment	Yes		

Other technical features



Display functions	Holiday, Fast-freezing, Fast-cooling, ECO, Child lock, Temperature alarm, Sabbath
Fast-freezing button	Yes
Water network connection	Yes
Power-on light	Yes
Temperature alarm	Yes
Door open alarm	Yes
Temperature setting type	Electronic
No. of compressors	1
Refrigerant gas type	R600a
Compressor type	Inverter
Foam agent	Cyclopentane

Performance / Energy Label

Noise level 44 dB(A) re 1 pW

Electrical Connection

Plug	(B) NEMA 5-15P	Voltage (V)	120 V
Current	2 A	Frequency (Hz)	60 Hz

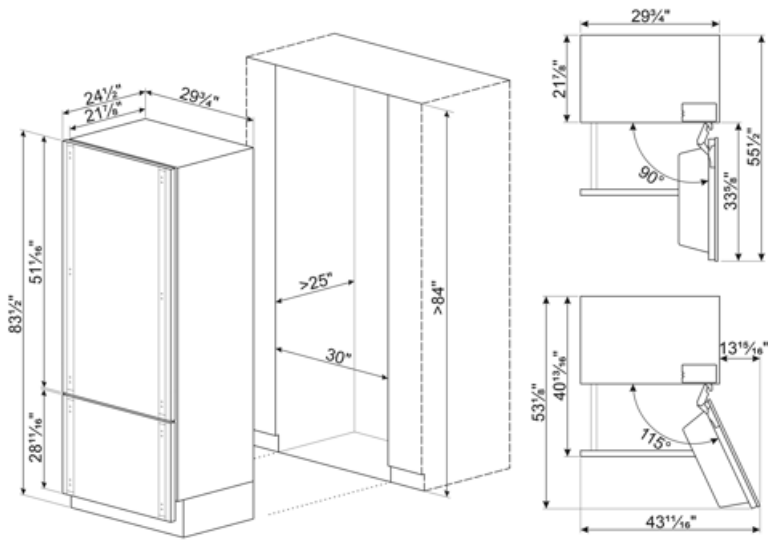













Compatible Accessories

KIT465H

Symbols glossary

	4 stars freezing compartment for better food preservation.		The automatic defrost system works by automatically defrosting at regular intervals eliminating the need to defrost altogether.
	Child lock: some models are fitted with a device to lock the programme/cycle so it cannot be accidentally changed.		Economical mode: Analyzes fridge functioning during the activation and optimizes the operating cycle in order to reduce power consumption.
	Fast freezing: The fast freezing function brings the temperature of the compartment down when activated a few hours prior to usage.		Power saving mode: The power saving mode allows you to disable the refrigerator and keep the freezer working.
	LED interior lighting: is a more energy efficient and long lasting way of illuminating the interior of the appliance.		Inverter technology: The evolution of Smeg's driers towards more intelligent and environmentally sustainable models has led to the choice of using Inverter technology with heat pumps, which reduces significantly energy consumption.
	Air plus: keeps food fresher for longer.		Sabbath: This function allows you to cook food during the Sabbath, the Holiday of rest in the Jewish religion, respecting the precepts. The oven works

Benefit (TT)

No-Frost system

The No Frost system prevents the formation of ice and contributes to better preservation of food in the refrigerator

Plastic multiflow system

The Multiflow system ensures even distribution of cold air inside the refrigerator

Refrigerant gas R600a

Environmentally friendly R600a refrigerant gas contributes to rapid cooling with lower energy consumption

Climate class

Climatic class SN-T makes the appliance suitable for working at room temperature between 10 °C and 43 °C (50 °F ~ 109 °F)

Self-supporting hinges

Self-supporting hinges ensure a perfect fit between the equipment door and the cabinet door, giving the product a minimalist and elegant appearance

Refrigerator Internal lighting

Interior lighting for perfect visibility of shelves in the refrigerator compartment

Fruit and vegetable drawer

The fruit and vegetable drawer ensures the best storage conditions for fresh food, avoiding any contamination

Inverter compressor

Inverter compressor reduces noise and vibration levels for a quiet and comfortable kitchen environment

Inverter compressor technology offers significant advantages for refrigeration systems, improving both performance and efficiency. Better temperature control ensures a more stable and constant indoor environment, preserving the freshness of food. This technology also results in reduced energy consumption, as the compressor adjusts its speed according to cooling needs.

Automatic ice maker with direct water connection

Constant ice availability thanks to the automatic ice maker, directly connected to the water supply for effortless and uninterrupted production

Internal display

Internal display for targeted temperature control and a clean, minimalist design