



## TRUE RESIDENTIAL®

36 INCH BUILT-IN BOTTOM FREEZER  
INSTALL GUIDE & USER'S MANUAL



PRESERVE THE MOMENT®



# THANK YOU

FOR YOUR PURCHASE

**NOTE: AS WE STRIVE FOR CONTINUOUS IMPROVEMENTS, FEATURES AND SPECIFICATIONS ARE SUBJECT TO CHANGE WITHOUT NOTICE.**

## INSTALLATION CHECKLIST

To ensure no part of the installation process has been overlooked, complete the checklist below.

- Have all packaging materials been removed?
- Are the anti-tip brackets securely installed and properly engaging the unit?
- Has the unit been properly leveled? Do all leveling legs touch the floor?
- Is the kickplate installed?
- Is the doorstop being installed (if needed)?  
TRUE offers a 90° door stop option. If a 90° door stop is required, please contact your dealer or True Customer Service at 888-616-8783.
- Does the customer understand the unit's operation?
- Has the customer been given the key and literature package?
- Have all stainless steel surfaces been inspected for imperfections?\*
- Is the unit operating correctly? If not, is the unit plugged in? Is the control turned on?

\*To be completed by either an installer with the customer or an authorized True dealer upon completion of installation. Stainless steel doors, handles, and shelves are covered by a limited 30-day warranty for cosmetic defects.

## TABLE OF CONTENTS

### SAFETY INFORMATION & OWNERSHIP

---

REFRIGERANT SAFETY & WARNING INFORMATION	6
BASIC SAFETY & WARNING PRECAUTIONS	6
APPLIANCE DISPOSAL WARNING	7
OWNERSHIP	8
NOTICE TO CUSTOMER	8
REGISTER YOUR PRODUCT	8
SERIAL LABEL LOCATION	8
APPLIANCE LOCATION	8
CONTACT INFORMATION	8

### PRIOR TO INSTALLATION

---

SITE PREPARATION	10
ROUGH OPENING & PLAN VIEWS	10
DUAL ROUGH OPENING	12
ANTI-SWEAT FOAM END PANELS	13
ELECTRICAL SAFETY & INSTALLATION REQUIREMENTS	14
POWER CORD	15
WATER SUPPLY REQUIREMENTS	16
WATER FILTER INSTALLATION & PERFORMANCE DATA	17

### INSTALLATION

---

UNCRATING	22
ANTI-TIP BRACKET INSTALLATION	25
LEVELING	26
KICKPLATE INSTALLATION	27
JOINING KIT INSTALLATION	26

### APPLIANCE SETUP

---

REFRIGERATOR STORAGE	34
FREEZER STORAGE	37
ICEMAKER	38
ICE MENU	39

### ELECTRONIC CONTROL OPERATION

---

USER INTERFACE	42
SET POINT MENU	43
ICE MENU	44
MODE MENU	46
SERVICE REPORT	47
LIGHT MENU	48
DOOR AJAR ALARM	49
SHOWROOM MODE	50
SYSTEM NOTIFICATIONS	51

### MAINTENANCE & SERVICING

---

INTERIOR ACCESSORIES	54
DOOR REMOVAL	54
APPLIANCE CARE & CLEANING	55
WATER FILTER REPLACEMENT	57
CONDENSER COIL CLEANING	59
HANDLE TIGHTENING	60
SERIAL LABEL LOCATION	60
CONTACT INFORMATION	60
COMPONENT REPLACEMENT	60

### WARRANTY STATEMENT

---

WARRANTY	61
----------	----

THE TRUE 36RF

36" BUILT-IN BOTTOM FREEZER  
STAINLESS SOLID DOOR



36" BUILT-IN BOTTOM FREEZER  
STAINLESS GLASS DOOR



LUXURY REFRIGERATION WITH COMMERCIAL DNA.



REFRIGERANT SAFETY & WARNING INFORMATION

BASIC SAFETY & WARNING PRECAUTIONS

APPLIANCE DISPOSAL WARNING

OWNERSHIP

NOTICE TO CUSTOMER

REGISTER YOUR PRODUCT

SERIAL LABEL LOCATION

APPLIANCE LOCATION

CONTACT INFORMATION



PRESERVE THE MOMENT®



**WARNING!** Use this appliance for its intended purpose as described in this Installation Manual.

This appliance is to be installed in accordance with local and federal regulations, as well as Safety Standard for Refrigeration Systems ANSI/ASHRAE 15.

## REFRIGERANT SAFETY & WARNING INFORMATION

See the serial label inside the appliance for the units refrigeration type. For Hydrocarbon Refrigeration (R-600a only), see below:



**DANGER!** Risk of fire or explosion. Flammable refrigerant used.

- **DO NOT** use mechanical devices to accelerate the defrost process or to clean.
- **DO NOT** puncture, pierce, or burn refrigerant tubing.
- Be aware that refrigerants may not contain an odor.
- Store the appliance in a room without continuously operating ignition sources.
- Follow handling instructions carefully.
- To be repaired only by trained service personnel.
- Consult repair manual/owner's guide before attempting to service this product. All safety precautions must be followed.
- Dispose of properly in accordance with local and federal regulations. Follow all safety precautions.



**CAUTION!** Keep all ventilation openings clear of obstruction in the appliance enclosure or in the structure housing the appliance.

## BASIC SAFETY & WARNING PRECAUTIONS

- Take care during operation, maintenance or repairs to avoid cuts or pinching from any part/component of the appliance.
- Units may pose a tipping hazard while uncrating, during installation, or when moving the unit.
- Ensure the unit is properly installed and located in accordance with the Installation Instructions before use.
- This appliance is not to be used, cleaned or maintained by persons (including children) with reduced physical, sensory or mental capabilities or lack of experience and knowledge, unless they have been given supervision or instruction.
- **DO NOT** allow children to play with the appliance or climb, stand, or hang on the unit's shelves to prevent damage to the refrigerator and personal injury.
- **DO NOT** touch the cold surfaces in the freezer compartment when hands are damp or wet. Skin may stick to these extremely cold surfaces.
- Unplug the refrigerator before cleaning and making repairs.
- Setting temperature controls to the 0 position or powering off an electronic control may not remove power from all components (e.g., light circuits, perimeter heaters, and evaporator fans).
- **DO NOT** store or use gasoline, or other flammable vapors and liquids, in the vicinity of this or any other appliance.

- **DO NOT** store explosive substances such as aerosol cans with a flammable propellant in this appliance.
- Keep fingers out of the "pinch point" areas; clearances between the doors and appliance are necessarily small; be careful closing doors when children are in the area.
- **DO NOT** use electrical appliances inside the food storage compartments of the units unless the appliances are of the type recommended by the manufacturer.

**NOTE: ALL SERVICING MUST BE PERFORMED BY A QUALIFIED TECHNICIAN.**

## APPLIANCE DISPOSAL WARNING



### DANGER! RISK OF CHILD ENTRAPMENT



Child entrapment and suffocation are not problems of the past. Junked or abandoned refrigerators are still dangerous, even if they will sit for "just a few days." If you are getting rid of your old refrigerator, please follow the instructions below to help prevent accidents.

#### Before throwing away your old refrigerator or freezer:

- Take off the doors.
- Leave the shelves in place so that children may not easily climb inside.

**DANGER!** Risk of fire or explosion. Flammable insulation and/or refrigerant used. Dispose of all in accordance with local and federal regulations. Follow all safety precautions.



## OWNERSHIP

To ensure that your unit works properly from the first day, it must be installed properly. We highly recommend a trained refrigeration mechanic and electrician install your True equipment. The cost of a professional installation is money well spent.

Before you start to install your TRUE unit, carefully inspect it for freight damage. **IF DAMAGE IS DISCOVERED, DO NOT INSTALL THE UNIT OR PUT IT IN SERVICE.** Notify True customer service, and immediately file a claim with the delivery freight carrier.

TRUE is not responsible for damage incurred during shipment.

For any questions about installation, please contact your True dealer or True Residential Technical Support at **844-746-9423** or **TrueResidentialService@TrueMfg.com**. Please have your model and serial number available.

## NOTICE TO CUSTOMER

Loss or spoilage of products in your refrigerator/freezer is **not covered by warranty**. In addition to following recommended installation procedures, run the refrigerator/freezer for 24 hours prior to usage to verify its proper operation.



## REGISTER YOUR PRODUCT

To qualify for TRUE's extended 7–12 year parts only sealed system warranty, you must register your product\* within 12 months of the unit's installation date. To register your unit, complete and submit the form at <https://true-residential.com/product-registration>. For warranty details, please see pg. 61.



\* Please note that ice machines do not qualify for this extended warranty.

## SERIAL LABEL LOCATION

The serial label is located on the upper right wall of the freezer drawer. See fig. 1.

This label contains important information such as your model name and serial number. Please have this information on hand when contacting True so we can better assist you with your service- or parts-related inquiries.



FIG. 1. Serial label location.

## APPLIANCE LOCATION

- This appliance has been tested for UL CSA to ISO Climate Class 5 [104°F (40°C) temperature, 40% relative humidity].
- Appliance is not suitable for outdoor use.
- Higher ambient conditions may reduce the appliance's performance.

## CONTACT INFORMATION

### CUSTOMER SERVICE

Phone: 888-616-8783  
info@true-residential.com

### WARRANTY DEPARTMENT

Phone: 844-849-6179  
TrueResidentialWarranty@truemfg.com

### TECHNICAL SUPPORT DEPARTMENT

Phone: 844-746-9423  
TrueResidentialService@truemfg.com

SITE PREPARATION

ROUGH OPENING & PLAN VIEWS

ANTI-SWEAT FOAM END PANELS

DUAL ROUGH OPENING

ELECTRICAL SAFETY & INSTALLATION REQUIREMENTS

POWER CORD

WATER SUPPLY REQUIREMENTS



PRESERVE THE MOMENT®

## SITE PREPARATION

Due to the weight of this unit, True recommends consulting a flooring expert prior to installation.

The flooring beneath the unit should be rated to support  $\geq 150 \text{ lb/ft}^2$  ( $732.36 \text{ kg/m}^2$ ).

**NOTE: IT IS NOT RECOMMENDED TO INSTALL UNITS SIDE BY SIDE WITH HINGES TOUCHING EACH OTHER. IF YOU PLAN TO INSTALL UNITS HINGE-TO-HINGE, YOU MUST HAVE A MINIMUM 1" (25.4 MM) GAP BETWEEN THE APPLIANCES BEING JOINED HINGE-TO-HINGE. JOINING KITS ARE NOT AVAILABLE FOR THESE APPLICATION**

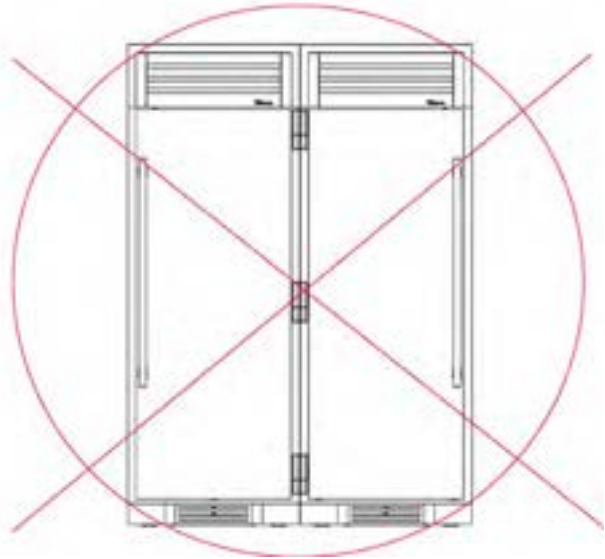

## ROUGH OPENINGS & PLAN VIEWS

### TR-36RBF

**Flush installation:** The front face of the unit is flush with the surrounding cabinets

**Proud (standard) Installation:** The front face of the unit extends beyond the surrounding cabinets

Rough Opening Dimensions		
	Flush Install	Proud Install
Width	36-1/4" (920.75 mm)	35-3/4" (908.05 mm)
Depth	26" (660.4 mm)	24" (609.6 mm)
Height	84-1/4" (2,139.95 mm)	84" (2,133.6 mm)

Note: Dimensions May Vary By  $\pm 1/8"$  (3.175 Mm)

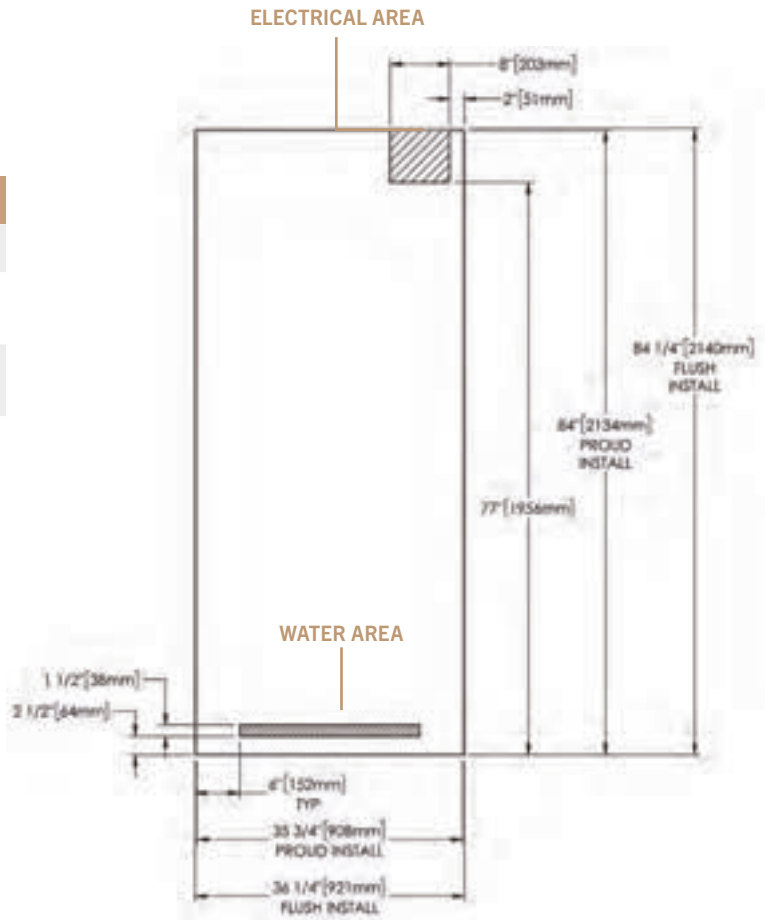

TR-36RBF PLAN VIEWS

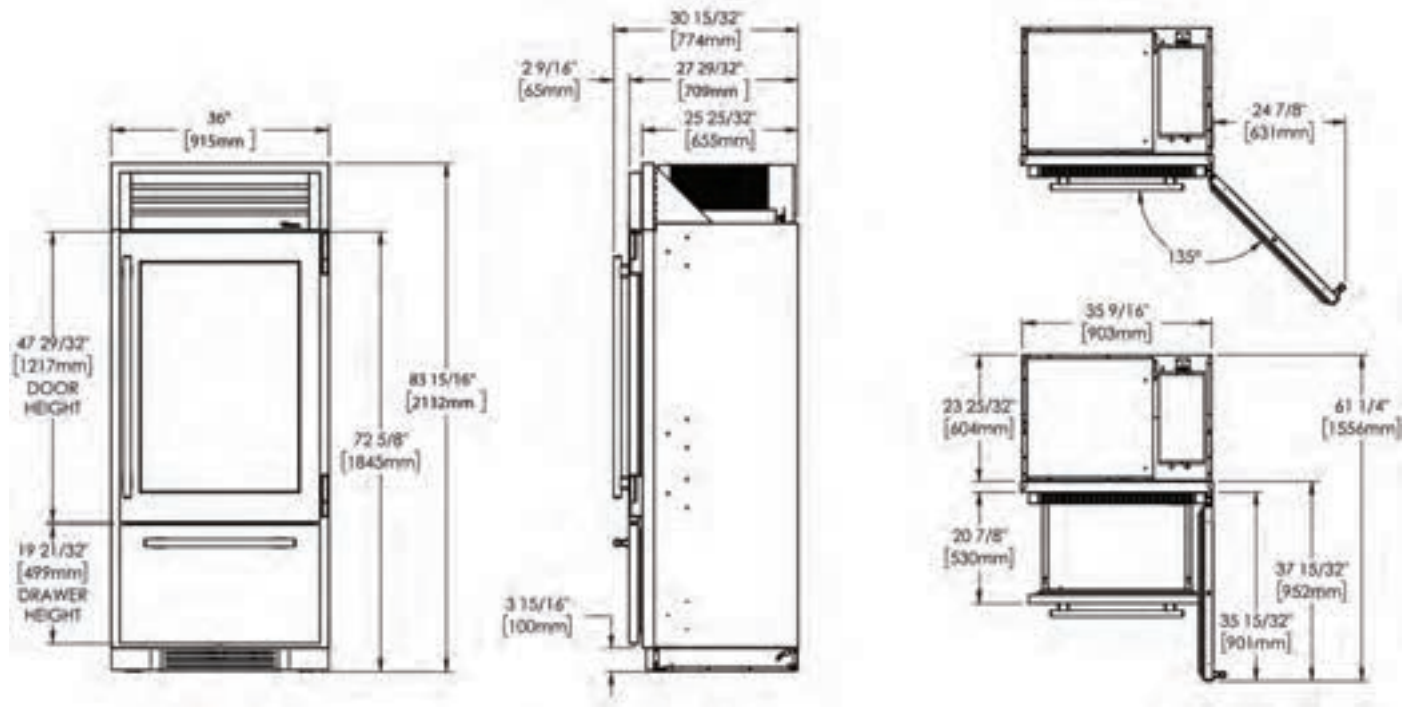

Note: Dimensions May Vary By ± 1/8" (3.175 Mm)

DUAL ROUGH OPENING & PLAN VIEWS

TR-36RBF / TR-36RBF

**Flush installation:** The front face of the unit is flush with the surrounding cabinets

**Proud (standard) Installation:** The front face of the unit extends beyond the surrounding cabinets

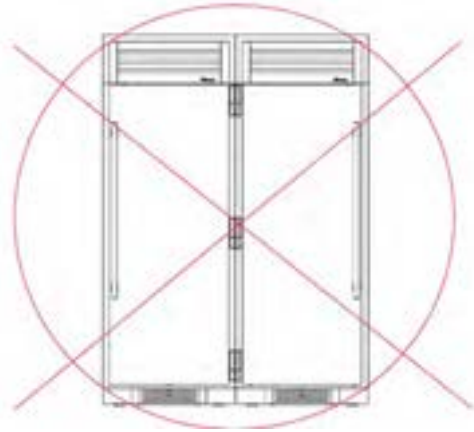

Rough Opening Dimensions		
	Flush Install	Proud Install
Width	72-1/4" (1835.15 mm)	71-3/4" (1822.45 mm)
Depth	26" (660.4 mm)	24" (609.6 mm)
Height	84-1/4" (2139.95 mm)	84" (2,133.6 mm)

Note: Dimensions May Vary By ± 1/8" (3.175 Mm)

**NOTE: IT IS NOT RECOMMENDED TO INSTALL UNITS SIDE BY SIDE WITH HINGES TOUCHING EACH OTHER. IF YOU PLAN TO INSTALL UNITS HINGE-TO-HINGE, YOU MUST HAVE A MINIMUM 1" (25.4 MM) GAP BETWEEN THE APPLIANCES BEING JOINED HINGE-TO-HINGE. JOINING KITS ARE NOT AVAILABLE FOR THESE APPLICATION.**

**NOTE: IF JOINING WITH OR INSTALLING NEXT TO ANOTHER TRUE COLUMN OR SBS APPLIANCE, THE TRUE COLUMN OR SBS APPLIANCE DOOR MUST BE SPECIAL-ORDERED FOR THE DOOR HANDLES TO ALIGN.**

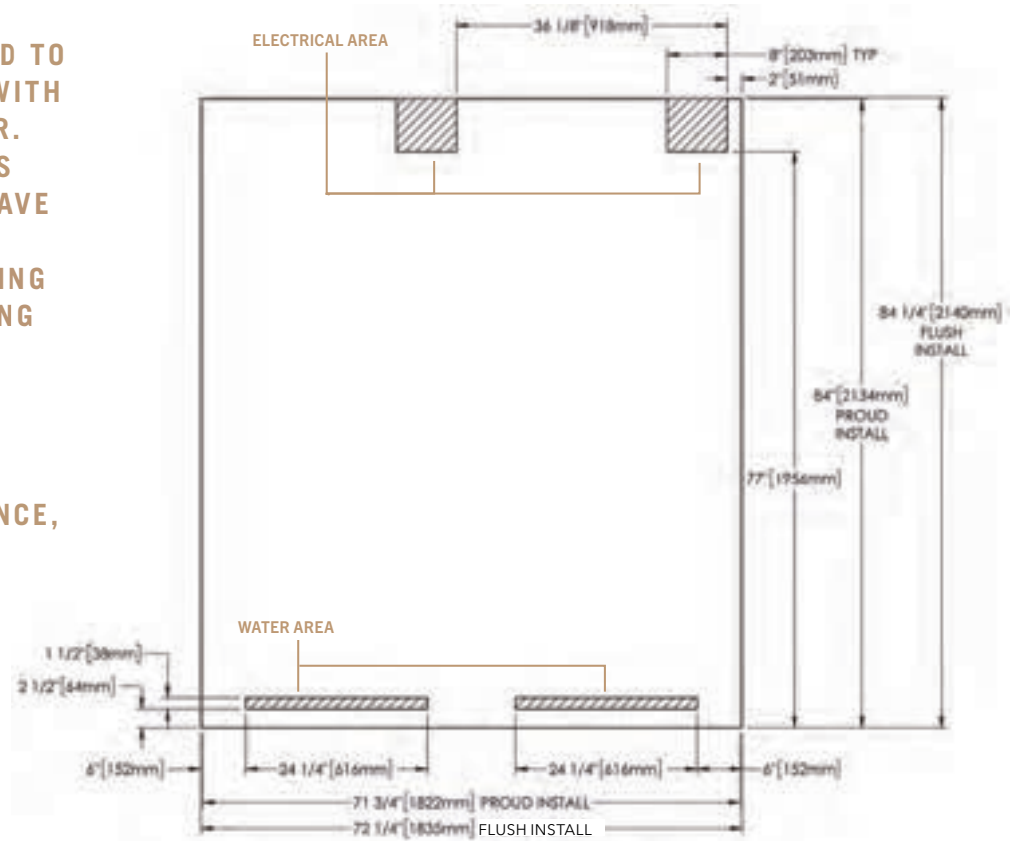

Note: Dimensions May Vary By ± 1/8" (3.175 Mm)

DUAL ROUGH OPENING & PLAN VIEWS (CONT.)

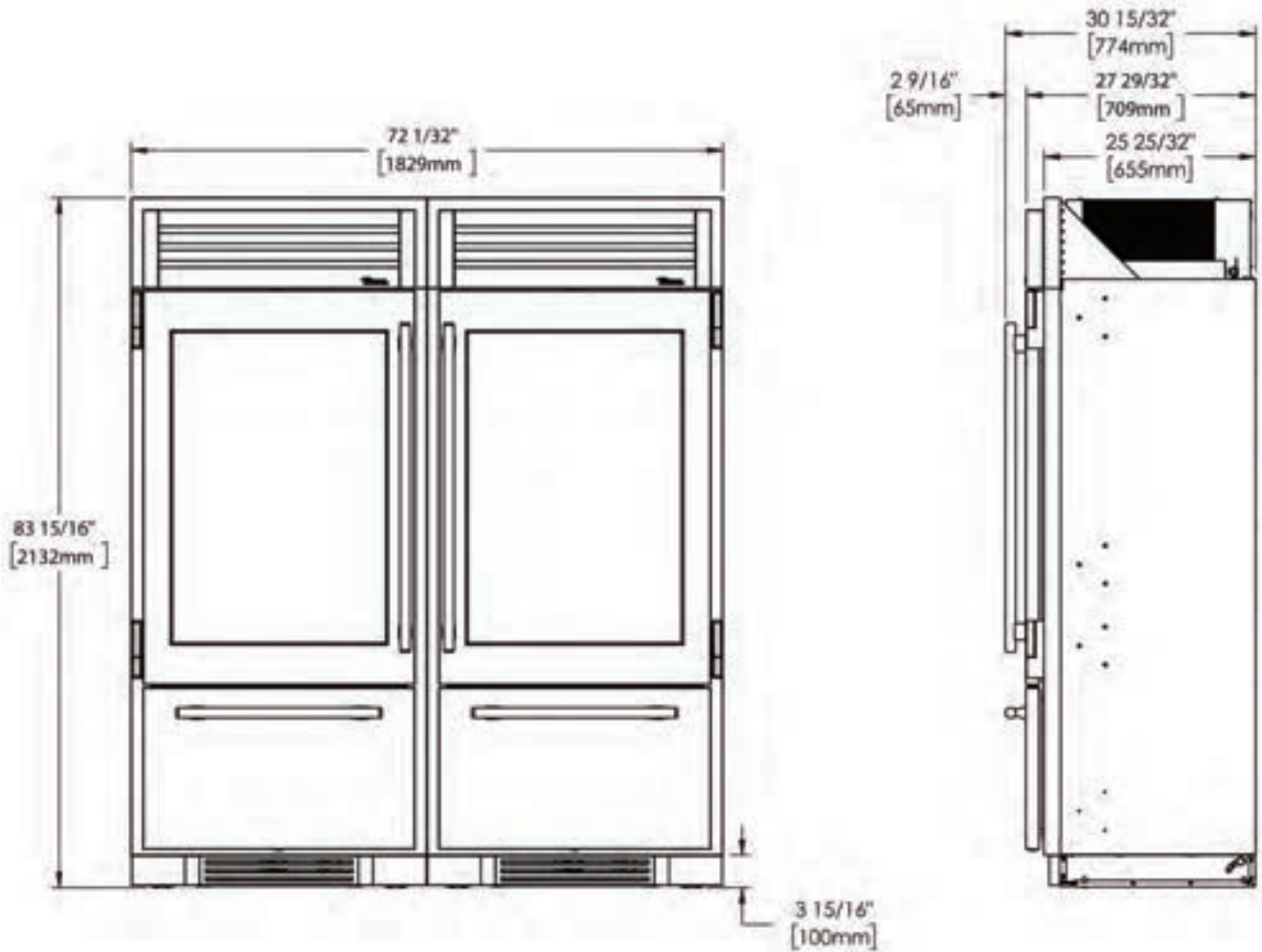

Note: Dimensions May Vary By  $\pm 1/8"$  (3.175 Mm)

ANTI-SWEAT FOAM END PANELS

When installing two or more True units side-by-side, be sure to install foam pads between the appliances (on each appliance) to prevent moisture from developing on applications.

True recommends applying a panel to each of the units being joined together. To order foam pads, contact our parts department at **844-849-6226** or [TrueResidentialParts@TrueMfg.com](mailto:TrueResidentialParts@TrueMfg.com).

## ELECTRICAL SAFETY

**Power Supply: 115VAC, 60hz**

**Circuit Breaker: 15 Amp**

**Receptacle: 3-Prong Grounding-Type**

- For all built-in models, the electrical supply should be located within the indicated shaded area shown in the figure below.
- Be sure to follow the National Electrical Code, as well as local codes and ordinances, when installing the receptacle.
- A ground fault circuit interrupter (GFCI) is not recommended and may cause interruption of operation.
- The power cord from this appliance is equipped with a grounding plug which minimizes the possibility of electric shock hazard.
- The wall outlet and circuit should be checked by a licensed electrician to be sure the outlet is wired with the correct polarity and properly grounded.
- If the outlet is a standard 2-prong outlet, it is your personal responsibility and obligation to have it replaced with a properly grounded wall outlet.
- **DO NOT**, under any circumstances, cut or remove the ground prong from the power cord. For personal safety, this appliance must be properly grounded.
- The refrigerator/freezer should always be plugged into a dedicated electrical circuit. This provides the best performance and prevents building wiring circuits from overloaded, which could cause a fire hazard from overheated wires.

- **NEVER USE AN ADAPTER PLUG!**

An adapter plug alters the original equipment manufacturer (OEM) plug configuration when connecting it to a power source. True will not warranty any refrigerator/freezer that has been connected to an adapter plug.



- **NEVER USE AN EXTENSION CORD!**

An extension cord is any component that adds length to the OEM power cord when connecting it to a power source. True will not warranty any refrigerator/freezer that has been connected to an extension cord.



- Before your new unit is connected to a power supply, check the incoming voltage. If the recorded voltage is less than the rated voltage for operation (+/-5%) and amp rating, correct immediately. Refer to the serial label for this voltage requirement.
- **NEVER** unplug your refrigerator/freezer by pulling on the power cord. Always grip the plug firmly and pull straight from the outlet.
- When moving the refrigerator/freezer for any reason, take care to not roll over or damage the power cord.
- Immediately repair or replace all power cords that have become frayed or otherwise damaged. **DO NOT** use a power cord that shows cracks or abrasion damage along its length or at either end.
- If the supply power cord is damaged, replace it with OEM components. To avoid hazard, this should be done by a licensed service provider or similarly qualified person.

ELECTRICAL SAFETY

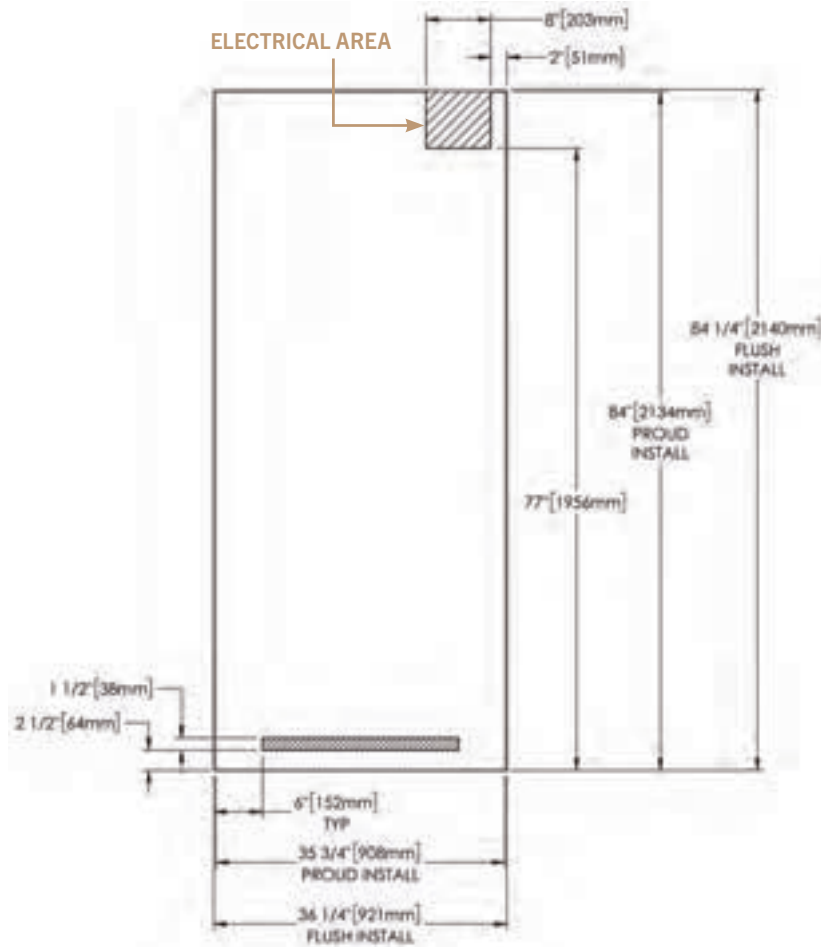

Note: Dimensions May Vary By  $\pm 1/8"$  (3.175 Mm)

POWER CORD

INSTALLATION

Fully seat the power cord into the cabinet receptacle until it locks in position. See fig. 1.

REMOVAL

Depress the red button. See fig. 2.



FIG. 1. Fully insert the power cord into the receptacle.



FIG. 2. Push the red button to remove the plug.

## WATER SUPPLY REQUIREMENTS



**WARNING! ONLY CONNECT YOUR APPLIANCE TO A POTABLE WATER SUPPLY.**

Units with icemakers come with 20" (508 mm) of polyethylene tubing with a 1/4" O.D. push connector for customer attachment.

Before installing your unit, prepare the water supply line. Please see plumbing requirements in the plumbing requirements table.

- Purge the water line prior to final connection to the unit. This removes any debris present in the line.
- Do not connect to a hot water supply!
- Install the water filter before turning on the water supply to the icemaker. See "Water Filter Installation" (pg. 17).
- A copper line is not recommended for this application.
- Check all water line fittings for leaks.
- Tape the supply line to the floor before moving the unit into its final installation location.
- **Your ice quality is only as good as the water supply quality and routine maintenance.** Hard water softened by a water softener can result in white, mushy cubes. TRUE recommends changing the water filter every six (6) months.
- In the water connection area (see the rough opening illustration), tape the water line to the floor.



FIG. 1. Water line connection. Fitting included, PEX not included

### Plumbing Requirements

<b>Water Supply</b>	1/4" PEX tubing (1/4" O.D. lines and fittings not included) <b>NOTE: Copper line is not recommended</b>
<b>Flow Rate</b>	0.5 gpm / 1.89 lpm
<b>Operating Pressure</b>	30-100 psi (207-689 kPa)
<b>Incoming Water Temperature</b>	33-100°F (0.6-38°C)

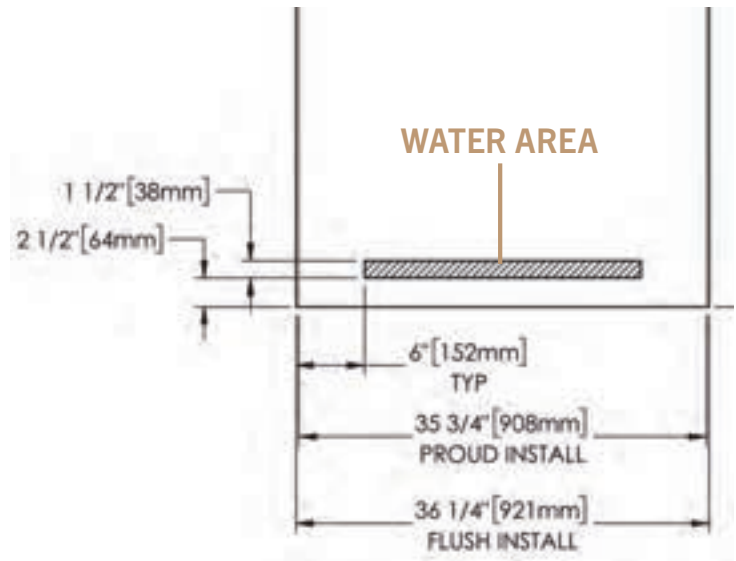

Note: Dimensions May Vary By  $\pm 1/8"$  (3.175 Mm)

WATER FILTER INSTALLATION & PERFORMANCE DATA



**WARNING! SHARP EDGES!** Take care when moving, installing, cleaning, servicing, and maintaining the appliance to avoid cuts. Be sure to take care when reaching under the appliance or handling metal components. Gloves recommended.



**WARNING! CHOKING HAZARD!** Small parts. Keep away from children under 8 years.



**NOTE: BEFORE CONSUMING ICE, DISCARD THE FIRST FULL BIN OF ICE (48 HOURS). THIS FLUSHES THE SYSTEM OF IMPURITIES.**

The water filters sediment and removes unpleasant taste and odor.

**NOTE: IF THE RESIDENCE IS EQUIPPED WITH A WATER FILTRATION SYSTEM, REVERSE OSMOSIS (RO) AND/OR WATER SOFTENER, DO NOT INSTALL THE WATER FILTER. THE APPLIANCE IS EQUIPPED WITH AN AUTOMATIC BYPASS.**

**PROCEDURE**

1. Remove the kickplate. See fig. 1.
2. Locate the provided water filter. See fig. 2.
3. Remove the outer packaging and the water filter cap. See fig. 3.
4. Inspect the water filter head and o-rings for damage. See fig. 4.
5. With the handle arrows (see fig. 5) vertical, insert the water filter into the filter receptacle. See fig. 6.
6. Rotate the water filter clockwise until the filter stops turning. See fig. 6 and 7.

**NOTE: THE HANDLE ARROWS SHOULD BE SLIGHTLY BEYOND HORIZONTAL. SEE FIG. 7.**

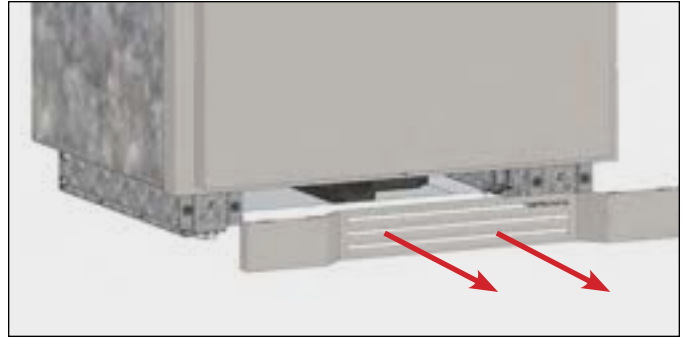

FIG. 1. Pull the kickplate from the cabinet.



FIG. 2. Locate the provided water filter shipped in the ice bucket.



FIG. 3. Sanitary cap over water filter head.



FIG. 4. Undamaged water filter head (A) vs. a damaged water filter head (B).

WATER FILTER INSTALLATION & PERFORMANCE DATA (CONT.)

7. Press and hold the test button\* on the icemaker (see fig. 8) for 5-10 sec. Then, check the water filter area for leaks. If leaks are detected, repeat step 6.
8. Reinstall the kickplate.
9. Before consuming ice, discard the first full bin of ice (48 hours). This flushes the system of impurities.

\*The test button cycles the icemaker. The ice tray will fill with water. Please note if the button is pressed and held multiple times, the tray will empty into the appliance. Make sure the ice bin is in place to catch the tray contents.

WATER FILTER PERFORMANCE DATA

- This system has been tested according to NSF/ANSI Standard 42, 53, 372, 401, P473 and CSA B483.1 for reduction of the substances listed below. The concentration of the indicated substances in water entering the system was reduced to a concentration less than or equal to the permissible limit for water leaving the system, as specified in NSF/ANSI Standards 42, 53, 372, 401, P473 and CSA B483.1.
- Systems certified for cyst reduction may be used on disinfected waters that may contain filterable cysts. The system conforms to NSF/ANSI 42, 53, 372, 401, P473 and CSA B483.1 for the specific performance claims as verified and substantiated by test data. Conforms to NSF/ANSI 53 for VOC reduction. See below for individual contaminants and reduction performance.

**NOTE: TESTING WAS PERFORMED UNDER STANDARD LABORATORY CONDITIONS, ACTUAL PERFORMANCE MAY VARY.**

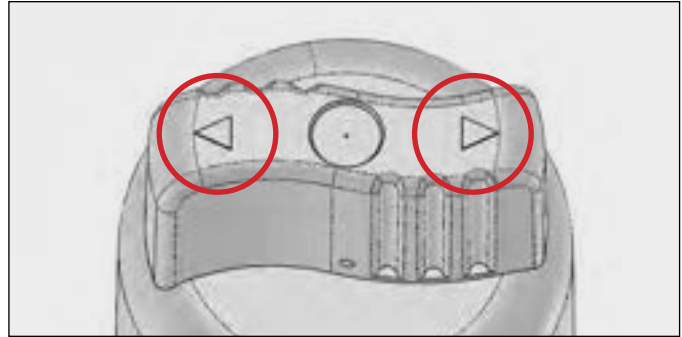

FIG. 5. Water filter handle arrow locations.



FIG. 6. Insert the water filter and rotate it clockwise.

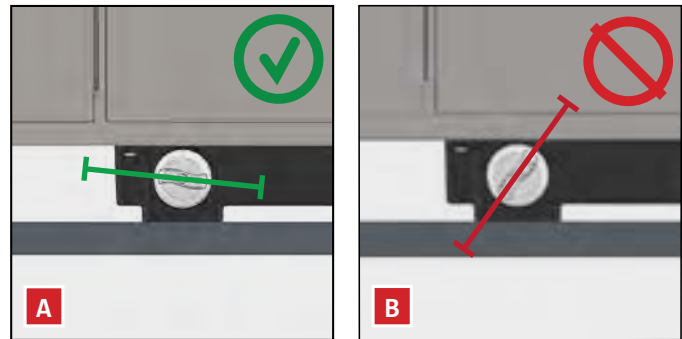

FIG. 7. Correct install (A) vs. incorrect install (B).



FIG. 8. Test button located on underside of icemaker by TRUE logo.

WATER FILTER INSTALLATION & PERFORMANCE DATA (CONT.)

- System to be used with municipal or well water sources treated and tested on regular basis to ensure bacteriological safe quality. Do not use with water that is microbiologically unsafe or of unknown quality without adequate disinfection before or after the system.
- It is essential that the manufacturer's recommended installation, maintenance and filter replacement requirements be carried out for the product to perform as advertised.

Filter Specifications	
Flow Rate	0.5 gpm / 1.89 lpm
Operating Temperature	33-100°F (0.6-38°C)
Operating Pressure	30-100 psi (kPa)
Capacity	300 gal. (1,136 L) or six months



Contaminant and Reduction Performance

Contaminant	% of reduction	Influent Concentration	Max Allowable
CHLORINE	>97%	2.0 mg/L	1.0 mg/L
ALACHLOR*	>98%	0.050	0.001
Asbestos	99.98%	189 MFL	99%
ATRAZINE*	>97%	0.100	0.003
BENZENE*	>99%	0.081	0.001
BISPHENOL	99.1%	2.058 mg/L	<0.300mg/L
BROMODICHLOROMETHANE (TTHM)*	>99.8%	0.300	0.015
BROMOFORM (TTHM)*	>99.8%	0.300	0.015
CARBOFURAN (Furadan)*	>99%	0.19	0.001
Carbon Tetrachloride	>95%	0.014	0.005
CHLORDANE	>99.5%	0.04 +/-10%	0.002
CHLOROBENZENE (Monochlorobenzene)*	>99%	0.077	0.001
CHLOROPICRIN*	99%	0.015	0.0002
CHLOROFORM (TTHM)* (surrogate chemical)	>99.8%	0.300	0.015
2, 4-D*	98%	0.110	0.0017
CYST (Giardi; Cryptosporidium; Entamoeba; Toxoplasma)	>99.95%	MINIMUM 50,000/L	99.95% REDUCTION REQUIREMENT
Cryptosporidium (see CYST)	>99.95%	MINIMUM 50,000/L	99.95% REDUCTION REQUIREMENT
DBCP (see Dibromochloropropane)*	>99%	0.052	0.00002
1,2-DCA (see 1,2-DICHLOROETHANE)*	95%	0.088	0.0048
1,1-DCE (see 1,1-DICHLOROETHYLENE)*	>99%	0.083	0.001
DIBROMOCHLOROMETHANE (TTHM; Chlorodibromomethane)*	>99.8%	0.300	0.015
DIBROMOCHLOROPROPANE (DBCP)*	>99%	0.052	0.00002
o-DICHLOROBENZENE (1,2 Dichlorobenzene)*	>99%	0.080	0.001
p-DICHLOROBENZENE (para-Dichlorobenzene)	>98%	0.040	0.001
1,2-DICHLOROETHANE (1,2-DCA)*	95%	0.088	0.0048
1,1-DICHLOROETHYLENE (1,1-DCE)*	>99%	0.083	0.001
CIS-1,2-DICHLOROETHYLENE*	>99%	0.170	0.0005
TRANS-1,2- DICHLOROETHYLENE*	>99%	0.086	0.001
1,2-DICHLOROPROPANE (Propylene Dichloride)*	>99%	0.080	0.001
CIS-1,3- DICHLOROPROPYLENE*	>99%	0.079	0.001
DINOSEB*	99%	0.170	0.0002
EDB (see ETHYLENE DIBROMIDE)*	>99%	0.044	0.00002
ENDRIN	99%	0.053	0.00059
Entamoeba (see CYSTS)	99.95%	MINIMUM 50,000/L	99.95% REDUCTION REQUIREMENT
ESTRONE	96.9%	0.1388 mg/L	<0.020 mg/L
ETHYLBENZENE*	>99%	0.088	0.001
ETHYLENE DIBROMIDE (EDB)*	>99%	0.044	0.00002
Furadan (see CARBOFURAN)*	>99%	0.19	0.001
Giardia Lamblia (see CYST)	>99.95%	MINIMUM 50,000/L	99.95% REDUCTION REQUIREMENT
HALOACETONITRILES (HAN)*			
BROMOCHLOROACETONITRILE	98%	0.022	0.0005
DIBROMOACETONITRILE	98%	0.024	0.0006
HALOACETONITRILES (HAN)*			
DICHLOROACETONITRILE	98%	0.0096	0.0002
TRICHLOROACETONITRILE	98%	0.015	0.0003

Contaminant	% of reduction	Influent Concentration	Max Allowable
HALOKETONES (HK):*			
1,1-DICHLORO-2-PROPANONE	99%	0.0072	0.0001
1,1,1-TRICHLORO-2-PROPANONE	96%	0.0082	0.0003
HEPTACHLOR*	>99%	0.25	0.00001
HEPTACHLOR EPOXIDE*	98%	0.0107	0.0002
HEXACHLOROBUTADIENE (Perchlorobutadiene)*	>98%	0.044	0.001
HEXACHLOROCYCLOPENTADIENE*	>99%	0.060	0.000002
IBUPROFEN	96.7%	0.432 mg/L	<0.060 mg/L
LEAD (pH 6.5)	>99.3%	0.15 +/- 10%	0.010
LEAD (pH 8.5)	>99.3%	0.15 +/- 10%	0.010
LINDANE*	>99%	0.055	0.00001
METHOXYCHLOR*	>99%	0.050	0.0001
Methylbenzene (see TOLUENE)*	>99%	0.078	0.001
Mercury (pH 6.5)	74.9%	0.0059	0.002
Mercury (pH 8.5)	97.8%	0.0061	0.002
Monochlorobenzene (see CHLOROBENZENE)*	>99%	0.077	0.001
NAPROFEN	95.3%	0.130 mg/L	<0.020 mg/L
NONYLPHENOL	97.1%	2.058 mg/L	<0.200 mg/L
POLYCHLORINATED BIPHENYLS (PCBs, Aroclor 1260)	>99.9%	0.01 +/- 10%	0.0005
PCE (see Tetrachloroethylene)	>96%	0.014	0.005
PENTACHLOROPHENOL*	>99%	0.096	0.001
Perchlorobutadiene (see HEXACHLOROBUTADIENE)*	>98%	0.044	0.001
PFOA	98.0%	0.0005 mg/L	<0.00007 mg/L
PFOS	98.0%	0.001 mg/L	<0.00007 mg/L
Phenytol	94.7%	0.2173 mg/L	<.030 mg/L
Propylene Dichloride (see 1,2-DICHLOROPROPANE)*	>99%	0.080	0.001
SIMAZINE*	>97%	0.120	0.004
STYRENE (Vinylbenzene)*	>99%	0.150	0.0005
1,1,1-TCA (see 1,1,1- TRICHLOROETHANE)*	95%	0.084	0.0046
1,2,4-Trichlorobenze	>99%	0.215	0.07
TCE (see TRICHLOROETHYLENE)*	>99%	0.180	0.0010
1,1,2,2- TETRACHLOROETHANE*	>99%	0.081	0.001
TETRACHLOROETHYLENE*	>99%	0.081	0.001
TOLUENE (Methylbenzene)*	>99%	0.078	0.001
TOXAPHENE	>92.9%	0.015 +/- 10%	0.003
2,4,5-TP (Silvex)*	99%	0.270	0.0016
Toxoplasma (see CYST)	>99.95%	MINIMUM 50,000/L	99.95% REDUCTION REQUIREMENT
TRIBROMOACETIC ACID*		0.042	0.001
1,1,1-TRICHLOROETHANE (1,1,1-TCA)*	95%	0.084	0.0046
1,1,2-TRICHLOROETHANE*	>99%	0.150	0.0005
TRICHLOROETHYLENE (TCE)*	>99%	0.180	0.0010
TRIHALOMETHANES (TTHM) (Chloroform; Bromoform; Bromodichloromethane; Dibromochloromethane)	>99.8%	0.300	0.015
Unsym-Trichlorobenzene (see 1,2,4-TRICHLOROETHANE)*	>99%	0.160	0.0005
Vinylbenzene (see STYRENE)*	>99%	0.150	0.0005
XYLENES (TOTAL)*	>99%	0.070	0.001



UNCRATING

ANTI-TIP BRACKET INSTALLATION

LEVELING

KICKPLATE INSTALLATION

JOINING KIT INSTALLATION



PRESERVE THE MOMENT®

## UNCRATING

### REQUIRED TOOLS

- Drill or ratchet
- 7/16" Deep well socket
- Cutting Tool



**WARNING! TIP OVER HAZARD.** Unit poses a tipping hazard when moving or during installation. Do not move the unit without the shipping brackets installed.

Do not remove the appliance from the pallet without assistance. Failure to do so may result in property damage, personal injury, or death.

**NOTE: YOUR APPLIANCE MAY NOT EXACTLY MATCH FIGURES SHOWN.**

### PROCEDURE

1. Inspect the pallet exterior packaging for visible damage. See fig. 1. Follow TRUE's recommended procedure for accepting deliveries.
2. Remove the exterior packaging. Inspect the unit's exterior for visible or cosmetic damage. See figs. 2 and 3.

**NOTE: DO NOT DISCARD THE KICKPLATE (SEE FIG. 4). IF MOVING THE UNIT A LONG DISTANCE (E.G., BETWEEN BUILDINGS OR ON STAIRS), DO NOT DISCARD THE EXTERIOR CARDBOARD.**



**FIG. 1.** Inspect the exterior packaging for visible damage.



**FIG. 2.** Inspect the unit's exterior for visible damage.



**FIG. 3.** Be sure to inspect the rainshield.



**FIG. 4.** Packaged kickplate ships tucked under the unit's front.

## UNCRATING (CONT.)

3. Closely inspect the unit's interior for damage (e.g., scratches by shelving or damage to the door seal). See fig. 5.

**NOTE: DO NOT REMOVE THE INTERIOR PACKAGING.**

4. Move the unit as close as possible to the final installation location.

**NOTE: SECURE THE DOOR BEFORE MOVING THE UNIT TO ITS FINAL LOCATION (SEE FIG. 6). REPACKAGE THE UNIT WITH THE EXTERIOR PACKAGING AS NEEDED BEFORE MOVING THE UNIT.**

5. Unbolt the shipping bracket from the castor housing. Then, remove the anti-tip bracket. See figs. 7 and 8.

**NOTE: DO NOT DISCARD THE ANTI-TIP BRACKET.**



**FIG. 5.** Inspect inside the unit for visible damage. Do not remove the interior packaging.



**FIG. 6.** Always secure the door closed before moving the appliance.



**FIG. 7.** Shipping bracket bolt locations.



**FIG. 8.** Anti-tip bracket shipping bolt locations. Other side not shown.

## UNCRATING (CONT.)

6. Slightly raise the rear leveling leg rollers. Turn the front adjustment screw 1/4-1/2 turn clockwise. See fig. 9.
7. With assistance, pull the unit off the back of the skid. Then, remove the skid and Carefully guide the unit to a fully upright position. See figs. 10a, 10b, and 10c.



**CAUTION!** Only lift with appliance moving equipment from the unit's sides, never the front or rear. See fig. 11. Failure to do so may result in personal injury or appliance damage. Do not lift the unit by handles, doors, or hinges.

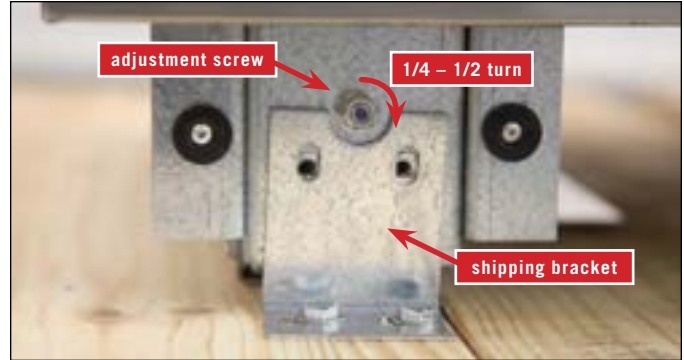

**FIG. 9.** Adjustment screw location. Other adjustment screw not shown.



**FIG. 10a.** With assistance, carefully walk the appliance partially off the back of the skid.



**FIG. 10b.** Then, tilt the unit backward and remove the skid.



**FIG. 10c.** Carefully guide the appliance to an upright position.



**FIG. 11.** Only lift with appliance moving equipment from the SIDES, NEVER the FRONT or REAR.

## ANTI-TIP BRACKET INSTALLATION

### KIT CONTENTS

- (1) One anti-tip bracket
- (4) Four 3/16" masonry screws
- (8) Eight #12-2" wood screws
- (12) Twelve 1/4" washers

### REQUIRED TOOLS

- Tape measure
- Marking utensil
- 1/8" drill bit
- 7/16" socket
- Phillips bit driver
- Drill or ratchet



**WARNING! TIP OVER HAZARD.** To avoid a hazard from appliance instability, install the anti-tip bracket in accordance with the instructions below.

### BEFORE YOU BEGIN

Consult a flooring expert to confirm that the flooring where the unit will be installed is rated for at least 150 pounds per square foot.

### 36RBF UNIT

#### TOP VIEW

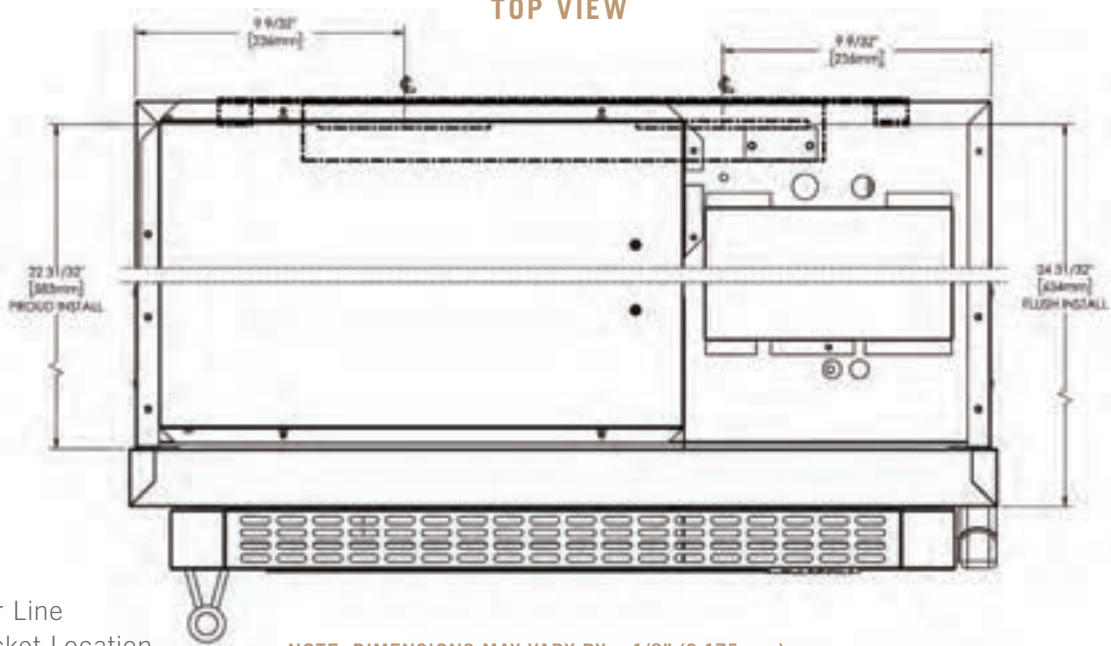

☉ = Center Line  
 --- = Bracket Location

**NOTE: DIMENSIONS MAY VARY BY ± 1/8" (3.175 mm)**

### PROCEDURE

1. Measure and mark the depth of the bracket's placement in the installation location.
    - Flush installation: 24-31/32" (634 mm)
    - Proud installation: 22-31/32" (584 mm)
  2. Place and center the bracket at the measured depth.
  3. With the bracket as a guide, drill pilot holes into the wall and/or floor.
- NOTE: FOR INCREASED STABILITY, SECURE THE BRACKET TO AS MANY JOISTS AND/OR STUDS AS POSSIBLE.**
4. With the provided hardware, secure the anti-tip bracket.
  5. Adjust the rear leveling rollers 1/4 turn clockwise.
  6. Slide the unit into place and hook the anti-tip bracket into the castor assembly slots.

## INSTALLATION

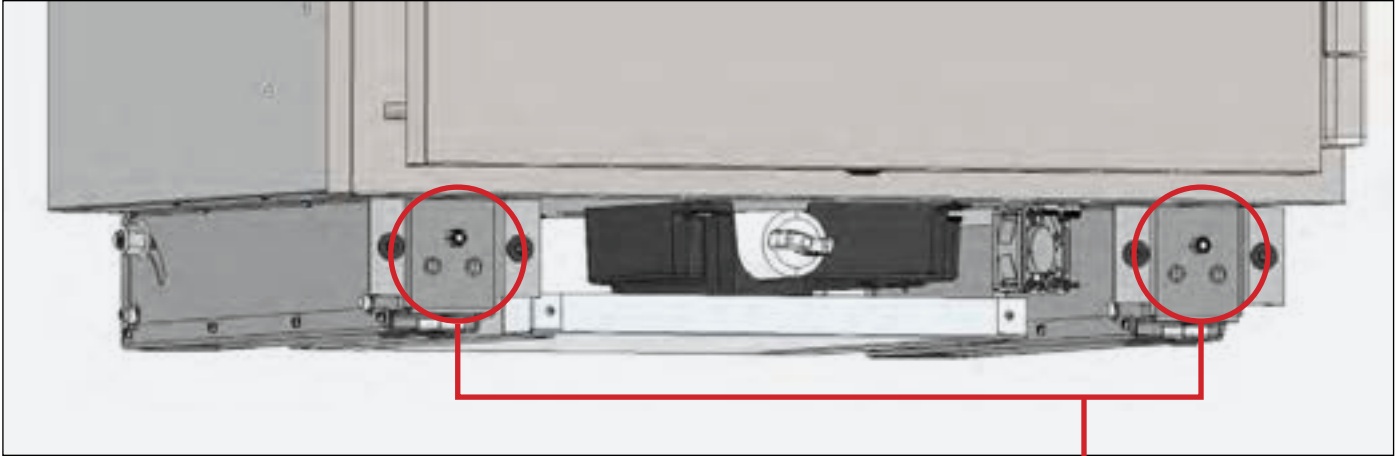

### LEVELING

Once the appliance is installed in its final location, it is important that it is properly leveled. When the appliance is properly leveled, doors, drawers, and rainshields are less likely to need adjustments. Proper leveling also ensures the gasket seals, drain pans do not spill over, and the best refrigeration performance.

### PROCEDURE

1. Verify the rear rollers and the front leveling legs are raised as high as possible and the appliance is resting on the castor bases.
2. Place a level on the appliance's interior floor. Check the level front-to-back and side-to-side.
3. If present, remove the kickplate. The kickplate is magnetically attached to the appliance. With a 7/16" socket, adjust the rear height. Turn the rear roller adjustment nut clockwise to raise the unit and counterclockwise to lower the unit.

**NOTE: ADJUST THE REAR HEIGHT JUST ENOUGH OR THE REAR ROLLER TO TOUCH THE GROUND.**

4. With the provided wrench, adjust the front leveling legs as needed. See fig. 1

**NOTE: ADJUST THE FRONT HEIGHT JUST ENOUGH FOR THE FRONT LEGS TO TOUCH THE GROUND.**

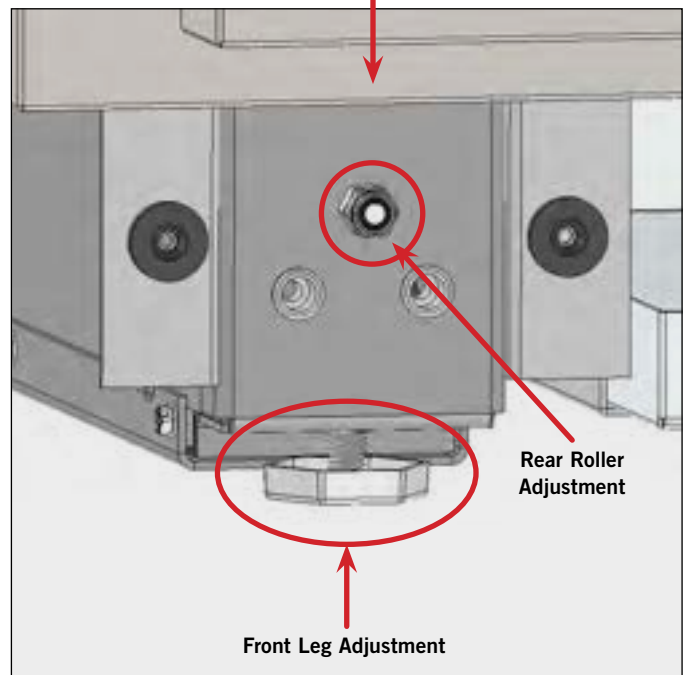

## KICKPLATE INSTALLATION

The kickplate (see fig. 1) is shipped unattached to the unit to allow easy access for leveling the unit. The kickplate attaches to the unit with magnets (see fig. 2) located on either side at the bottom of the unit.

### INSTALLATION

After leveling the unit, position the kickplate at the bottom of the unit's front. See fig. 3.

### REMOVAL

Pull the kickplate away from the unit.

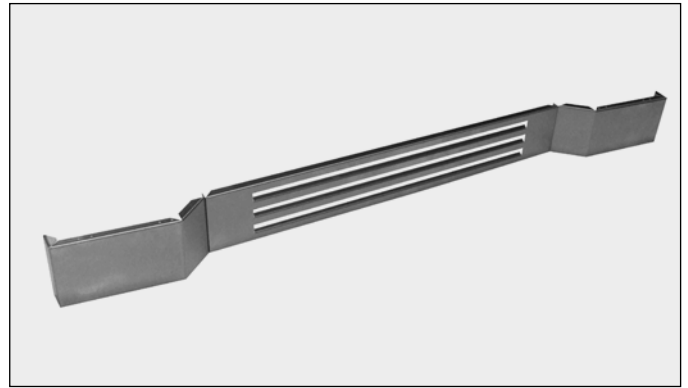

FIG. 1. The kickplate.

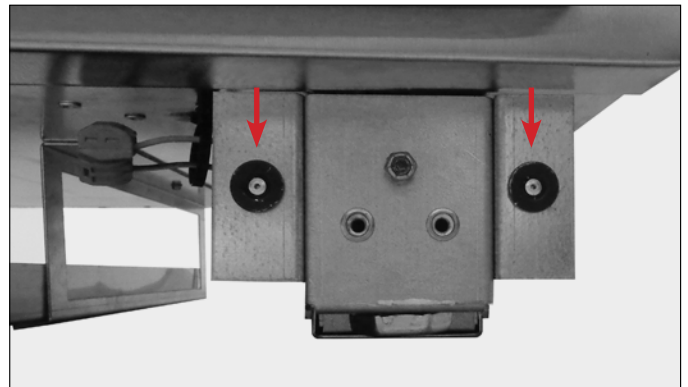

FIG. 2. The magnets. One side shown.



FIG. 3. Installed kickplate.

## JOINING KIT INSTALLATION

Kit Sizes: 60" (1524 mm) / 72" (1828.8 mm) / 78" (1981.2 mm) / 90" (2286 mm) / 102" (2591 mm) / 120" (3048 mm)

### KIT CONTENTS

- (1) Joining Rainshield Assembly
- (1) Joining Kickplate
- Anti-Sweat Foam End Panels\*
- Joining Bracket\*
- 1/4-20 x 1" Hex Head Screws\*
- 1/4" Split Lock Washers\*

\*Quantities vary by kit size.

### REQUIRED TOOLS

Required tools include (but may not be limited to) the following:

- Phillips Bit Driver or Screwdriver
- 7/16" Socket Wrench
- 1/4" Socket Wrench
- Tape
- Marking Utensil
- Drill

**NOTE: MAKE SURE THE ANTI-TIP BRACKETS ARE INSTALLED PER INSTALLATION MANUAL INSTRUCTIONS. EACH UNIT WILL ALSO NEED TO BE PROPERLY LEVELED PER INSTALLATION MANUAL INSTRUCTIONS.**



**CAUTION!** Electrical shock or burn hazard. Unplug the unit or turn off the power supply before proceeding.



**WARNING! TIP OVER HAZARD.**

To avoid hazards from appliance instability, be sure to install the anti-tip brackets (see fig. 1) on each individual unit per the installation manual instructions. If the appliance is moved, verify that the device is properly engaged before the normal usage of the appliance commences.

### PROCEDURE

1. Remove the reed switch bracket. See figs. 2 and 3.
2. Remove the reed switch cover, and then disconnect the reed switch. See figs. 4 and 5.



**NOTE: IF FOUR (4) WIRES ARE CONNECTED TO THE REED SWITCH, BE SURE TO CLEARLY LABEL THE WIRES' ORIGINAL LOCATIONS BEFORE DISCONNECTING THE REED SWITCH. WIRE LOCATION IS CRITICAL TO THE APPLIANCE'S OPERATION. SEE FIG. 5.**

3. Remove the reed switch wire from the rainshield. See figs. 6 and 7.
4. Remove the rainshield. See figs. 8-10.
5. Repeat steps 1-4 for each unit of the joined installation.
6. Remove the inner magnet brackets (see figs. 11 and 12). Then, thread and tighten the magnet bracket screws. Discard the magnet bracket.

**NOTE: BE SURE TO RETURN MAGNET BRACKET SCREWS TO THEIR ORIGINAL POSITIONS; THE SCREWS SUPPORT THE CASTOR ASSEMBLY HOUSING.**



**FIG. 1.** Anti-tip bracket. Be sure to install a bracket for each unit.

## JOINING KIT INSTALLATION (CONT.)

Kit Sizes: 60" (1524 mm) / 72" (1828.8 mm) / 78" (1981.2 mm) / 90" (2286 mm) / 102" (2591 mm) / 120" (3048 mm)



**FIG. 2.** Pull the rainshield open.



**FIG. 3.** Locate the reed switch in the bottom of the rainshield.



**FIG. 4.** Remove the plastic cover.

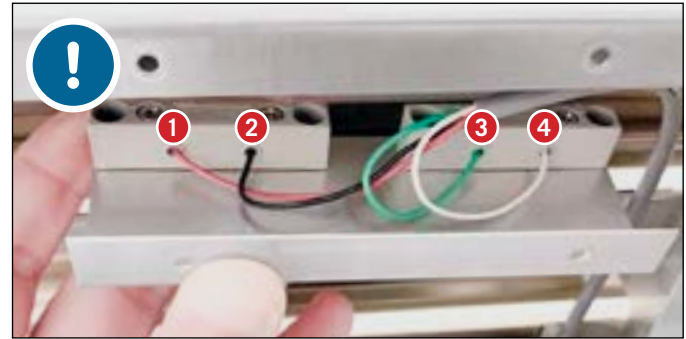

**FIG. 5.** Label the original wire locations **BEFORE** disconnecting the reed switch.



**FIG. 6.** Remove the p-clip holding the wire to the rainshield.



**FIG. 7.** Pull the reed switch wire through the rainshield bushing.

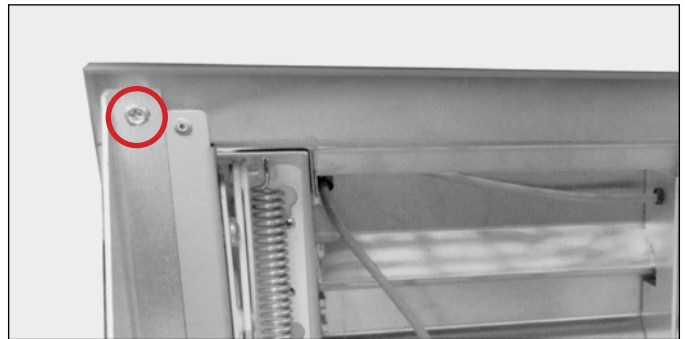

**FIG. 8.** Bracket screw location. Other bracket not shown.



**FIG. 9.** Rainshield screw locations.

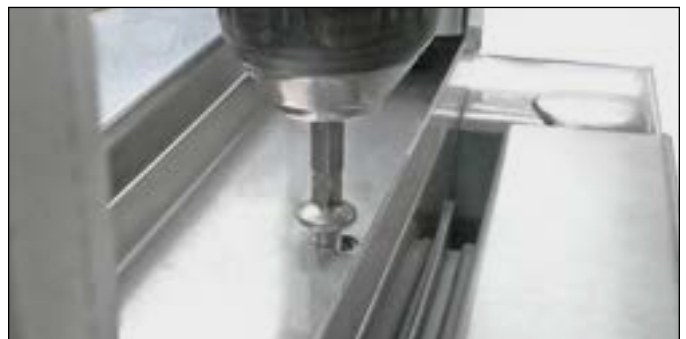

**FIG. 10.** Remove the screws from the metal channel.

## JOINING KIT INSTALLATION (CONT.)

Kit Sizes: 60" (1524 mm) / 72" (1828.8 mm) / 78" (1981.2 mm) / 90" (2286 mm) / 102" (2591 mm) / 120" (3048 mm)

7. Install anti-sweat foam end panels on the joined units' sides where the appliances will meet. See figs. 13 and 14.
8. Position the units in front of the final installation location. Then, level the units.
9. Verify the fronts of the units are flush at the seams and the gap(s) between the units is (are) consistent from top to bottom. See figs. 15 and 16.
10. With the provided hardware, install the joining bracket across the interior legs. See figs. 17 and 18.
11. With the existing hardware, install the joining rainshield assembly. See fig. 19.

**NOTE: ASSISTANCE (AT LEAST TWO (2) PEOPLE) RECOMMENDED.**

12. Route the reed switch wires through the rainshield. See figs. 6 and 7.
13. With the predrilled holes in the joining rainshield, connect and install the reed switches near the handle-side of the units.



**NOTE: BE SURE TO CONNECT THE WIRES TO THE REED SWITCH AS ORIGINALLY CONFIGURED. WIRE LOCATION IS CRITICAL TO THE APPLIANCE'S OPERATION. SEE FIGS. 5 OR 20.**

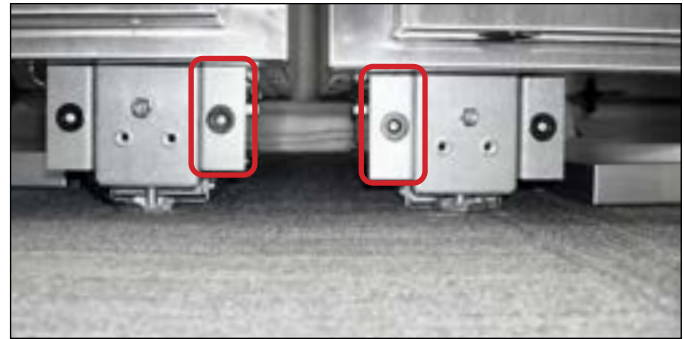

**FIG. 11.** Remove and discard the interior magnet brackets.



**FIG. 12.** Magnet bracket screw locations.



**FIG. 13.** Install the anti-sweat foam panel where the unit will be positioned next to another unit.

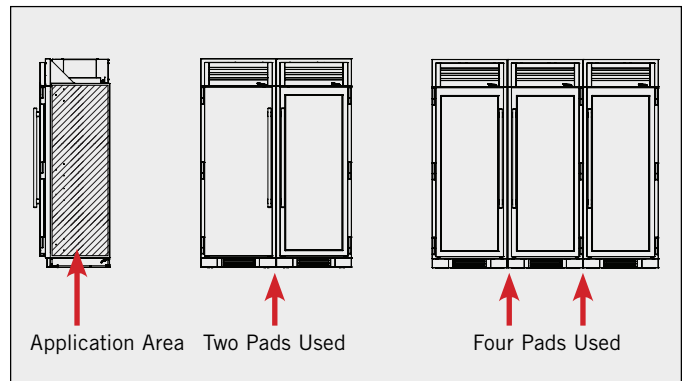
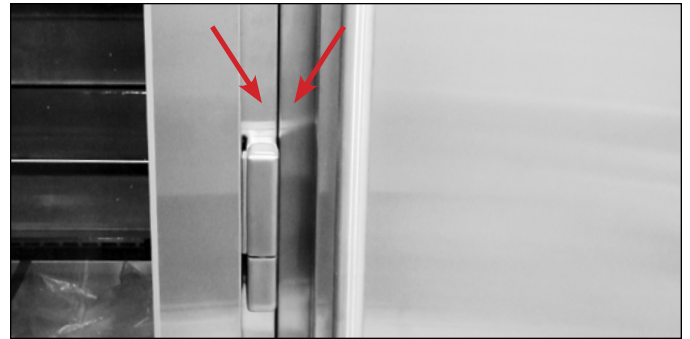

**FIG. 14.** Install foam pads between the joined units.

## JOINING KIT INSTALLATION (CONT.)

Kit Sizes: 60" (1524 mm) / 72" (1828.8 mm) / 78" (1981.2 mm) / 90" (2286 mm) / 102" (2591 mm) / 120" (3048 mm)

14. Walk the joined units into their final installation location.
15. Verify the level of the appliances. Level the units as needed.
16. Restore power to the units and turn the units on.
17. After 3 minutes of runtime, open the doors individually and verify correct door switch operation. When operating correctly, the following should occur:
  - Unless set otherwise, the lights turn on and off with the door openings.
  - The evaporator (interior) fan turns on and off with door openings.
  - There is a low-pitched click from the control board area when the door opens or shuts.
18. Install the joining kit grill.



**FIG. 15.** Verify the appliance fronts are flush. Adjust the units accordingly.

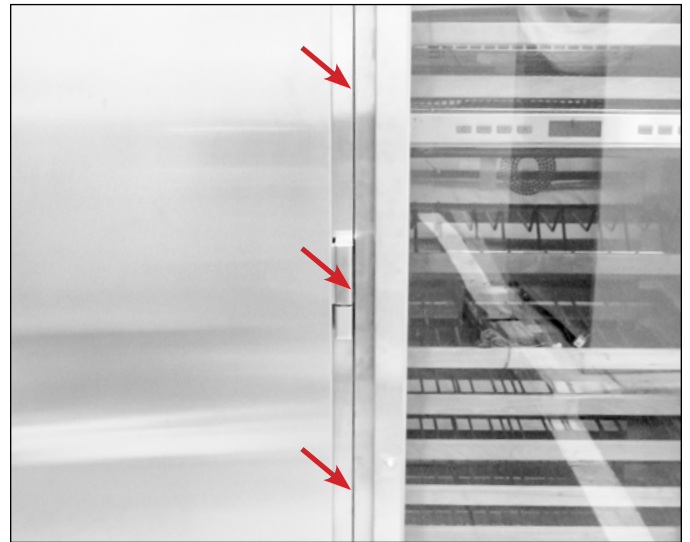

**FIG. 16.** Verify the gap(s) between appliances is (are) even throughout.

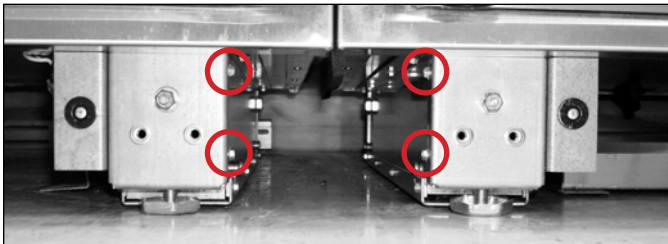

**FIG. 17.** Return the magnet bracket screws to their original locations



**FIG. 18.** Installed joining bracket.

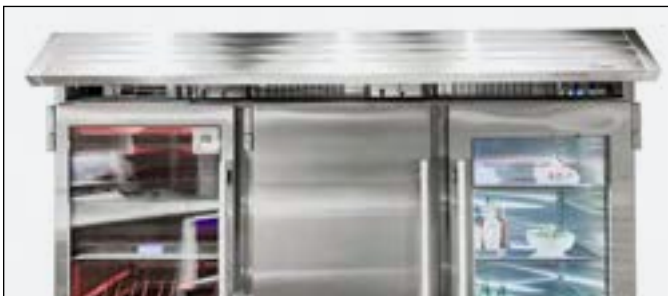

**FIG. 19.** Installed joining rainshield.

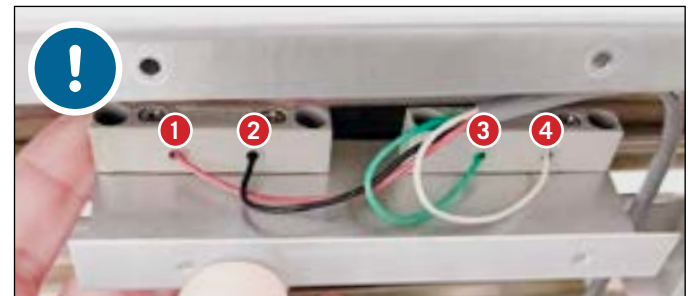

**FIG. 20.** Connect the reed switches with the original wire configurations.



REFRIGERATOR STORAGE

FREEZER STORAGE

ICEMAKER

ICE MENU



PRESERVE THE MOMENT®

## REFRIGERATOR STORAGE

The refrigerator section of the appliance is divided into shelving and produce / crisper bins.

### SHELVING

Shelving is adjustable for customer application.

### SHELF ADJUSTMENT

Shelving comes taped in place to prevent moving during shipping. See fig. 1.

This appliance meets the IEC shelf weight capacity of 47 lb/ft<sup>2</sup> (230 kg/m<sup>2</sup>).

**NOTE: THE SIDE MICROFILM PREVENTS COSMETIC DAMAGE WHEN ADJUSTING SHELVING. DO NOT REMOVE THE SIDE MICROFILM UNTIL ALL SHELVES ARE POSITIONED AS DESIRED. SEE FIG. 2.**

**NOTE: YOUR APPLIANCE MAY NOT MATCH THE FIGURES SHOWN.**



FIG. 1. Packaged shelving.



REFRIGERATOR STORAGE (CONT.)

1. Remove the shelf shipping clips. See fig. 3.
2. Remove the shipping tape from the shelf.

**NOTE: TRUE RECOMMENDS PULLING THE TAPE FROM THE TOP.**

3. Remove the shelf. See fig. 4.
4. Install the shelf at the desired height.

**NOTE: BE SURE THE SHELF IS FULLY SEATED. SEE FIG. 5. PUSH THE BOTTOM TABS INWARD IF THE SHELF DOES NOT SIT FLAT. SEE FIG. 6.**

5. Repeat steps 2-4 for the remaining shelves.
6. Remove the side microfilm. See fig. 7.

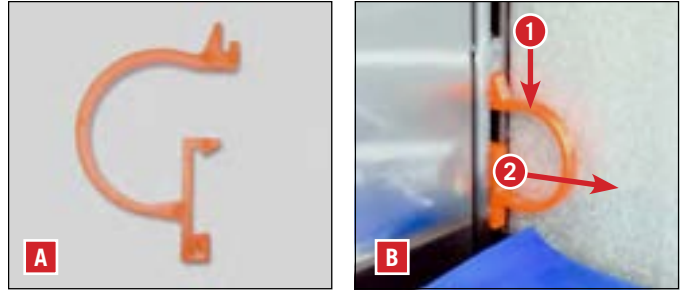

FIG. 3. Remove the shelf shipping clip (A) from the shelf standard (B).

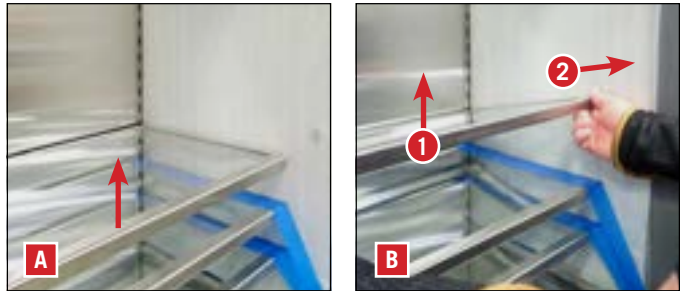

FIG. 4. Lift the shelf front up (A). Then, lift the shelf back and pull forward (B).

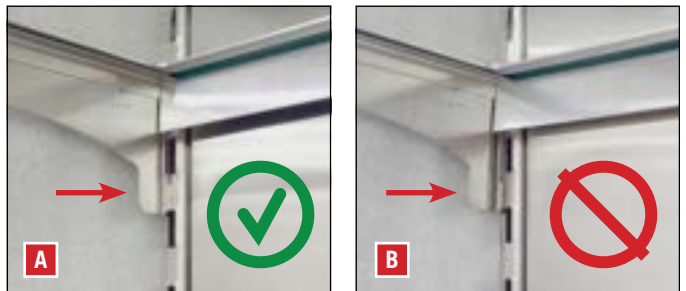

FIG. 5. Underside view. Left side shown.  
**A: CORRECT;** Bottom tab is fully seated in the shelf standard.  
**B: INCORRECT;** Bottom tab is not seated in the shelf standard.



FIG. 6. Push the bottom tab inward.



FIG. 7. Completed shelf installation.

REFRIGERATOR STORAGE (CONT.)

**DOOR BINS (SOLID DOORS ONLY)**

Door bins are only available for solid door units.

1. Locate the door bins packaged in the top refrigerator drawer. See fig. 4.
2. Hook the door into the door slots at the desired height. See fig. 5.
3. Push the door bins down to ensure the tabs are fully engaged in the slots. See fig. 6.

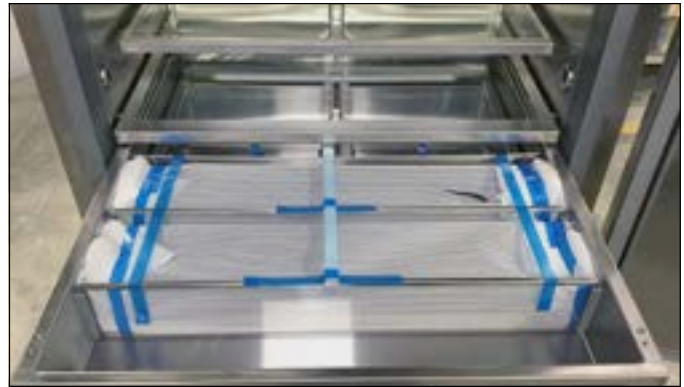

FIG. 4. Door bins packaged in the top refrigerator drawer.

**PRODUCE / CRISPER BINS**

The refrigerator section has three drawers. See the instructions below for drawer removal or reinstallation.

**BIN REMOVAL**

1. Fully open the drawer.
2. With a Phillips screwdriver, remove the drawer slide screws. See fig. 7.
3. Lift the drawer from the unit.

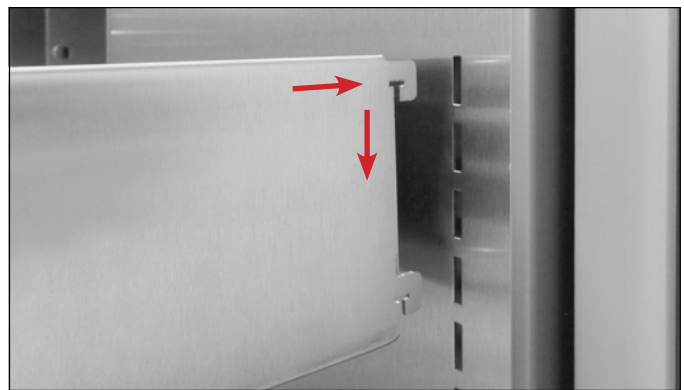

FIG. 5. Hook the door bin into the door.

**BIN INSTALLATION**

1. Pull the drawer slides fully forward.
2. Slide the drawer into position until the drawer rests under the rear hooks on the drawer slides.
3. With a Phillips screwdriver, fasten the drawer to the drawer slides.



FIG. 6. Be sure the door bins are fully seated.



FIG. 7. Drawer slide screw locations. Top drawer shown.

## FREEZER STORAGE

The freezer drawer of the appliance is divided into two sections. The top section holds the ice bin (see fig. 1).

**NOTE: IT IS NOT RECOMMENDED TO REMOVE THE ICE BIN, EVEN IF THE ICEMAKER IS NOT IN USE. THE ICE BIN PREVENTS PRODUCT DAMAGING THE ICEMAKER.**

### DRAWERS

See the instructions below for drawer removal or reinstallation.

#### DRAWER REMOVAL

1. Fully open the drawer.
2. With a Phillips screwdriver, remove the drawer slide screws. See fig. 2.
3. Lift the drawer from the unit.

#### DRAWER INSTALLATION

1. Pull the drawer slides fully forward.
2. Slide the drawer into position until the drawer rests under the rear hooks on the drawer slides.
3. With a Phillips screwdriver, fasten the drawer to the drawer slides.



FIG. 1. Do not remove the ice bucket.



FIG. 2. Drawer slide screw locations. Not all locations shown.

## ICEMAKER

The icemaker (see fig. 1) is below the lowest shelf and on the left in the freezer section. For water supply requirements, please see “Water Supply Requirements” (pg. 19). To turn the icemaker on, please see “Ice Menu Navigation” (pg. 44).

- See “Water Filter Installation” (pg. 16) for installation instructions.
- After the initial startup, **discard the first full bin of ice (48 hours)**. This ice may contain impurities from new plumbing connections.
- Do not remove the ice bin, even if the icemaker is not in use. The ice bin prevents stacked product from damaging the icemaker.
- If ice is not used regularly, it may fuse together. To avoid this, discard the ice and allow the ice maker to replenish.

### ICE SCOOP

The ice scoop ships inside the ice bin. See fig. 2.

### MAX ICE

When the max ice is turned on, the unit maximizes ice production for 24 hours. For information on turning Max Ice on or off, please see “Ice Menu Navigation” (pg. 44).



FIG. 1. The icemaker.



FIG. 2. The ice scoop ships inside the ice bin.

## ICE MENU

To enter the Ice Menu, press ICE on the user interface. Use the UP and DOWN arrows to navigate between the menu options and use ICE to make a selection. See the diagram below.

The Ice Menu contains three operations.

- Ice Maker: Toggles the icemaker between on/off.
- Max Ice: Maximizes ice production for 24 hours.
- Water Filter Reset: Immediately resets the countdown to change the water filter.

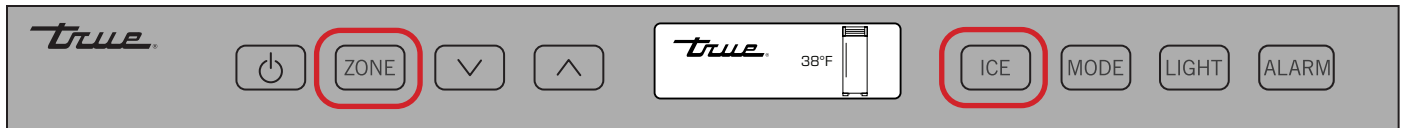

To change selection (dark highlight/white text).  
 To toggle ICE MAKER and MAX ICE between ON and OFF. Return to home if EXIT is highlighted.

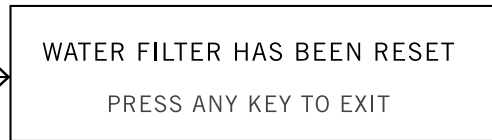

ANY KEY



**ICE TROUBLESHOOTING**

Please see the table below to troubleshoot some common problems with ice production. If your issue is not resolved, please contact True Residential Technical Support at **844-746-9423** or **TrueResidentialService@TrueMfg.com**.

Icemaker Troubleshooting	
<b>No ice</b>	<ul style="list-style-type: none"> <li>• Verify the water filter is installed</li> <li>• Verify water is being supplied to the unit</li> <li>• Verify the icemaker is on at the display and on the icemaker itself (see fig. 1) and has been running for at least 24 hours</li> <li>• Verify the ice bin is positioned correctly</li> <li>• Verify the freezer temperature is near 0°F (-17.8°C)</li> <li>• Verify the water filter has been replaced within the last 12 months and has been installed correctly</li> </ul>
<b>Black flecks in the ice cubes</b>	Stop use and contact True Residential Technical Support
<b>Bad taste</b>	<ul style="list-style-type: none"> <li>• Defrost the freezer and clean with soap and water</li> <li>• Place coffee grounds or charcoal briquettes in the freezer to absorb odor</li> </ul>
<b>Hollow cubes</b>	Clean the condenser coil. Contact True Residential Technical Support if the issue is unresolved.

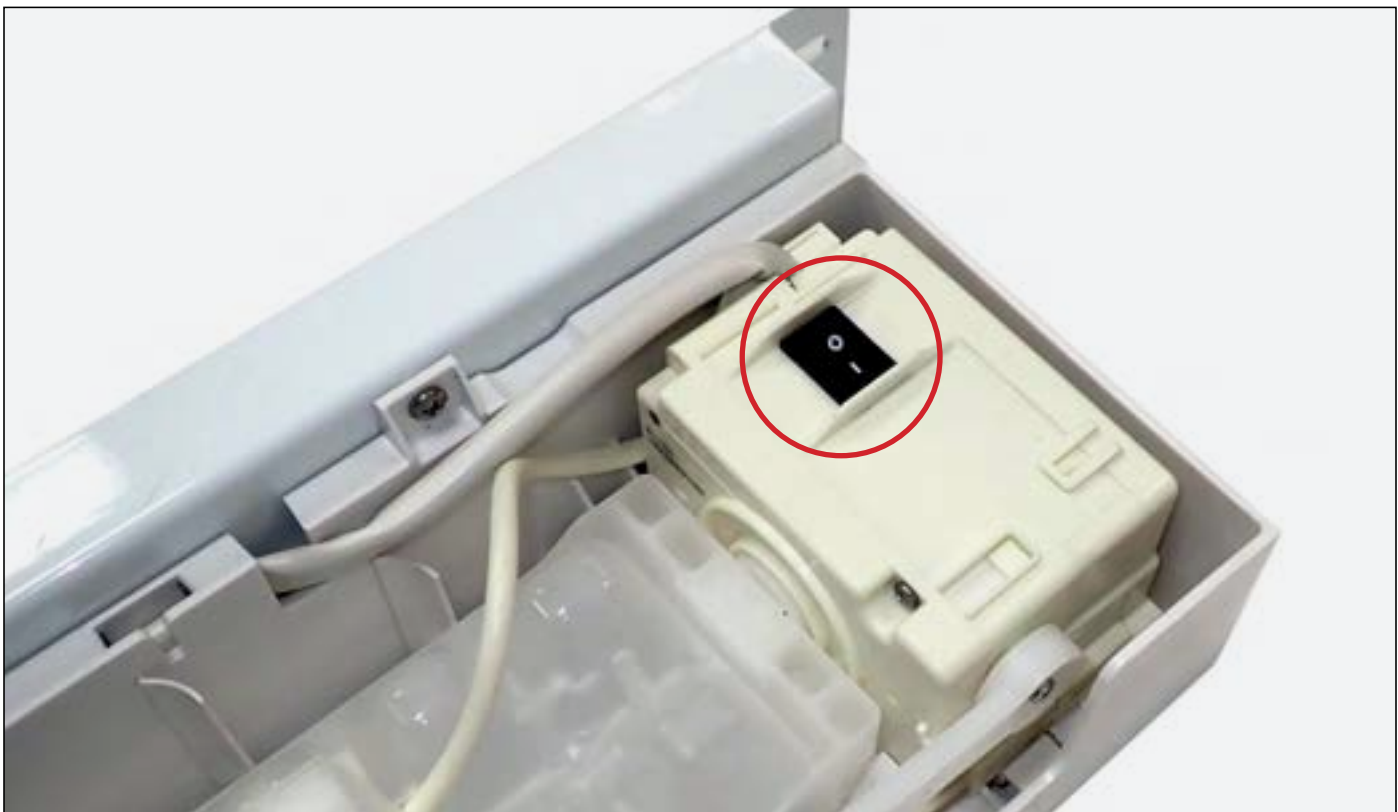

**FIG. 1.** Off/on switch on the bottom of the icemaker near the TRUE logo.

NOTE: AN ELECTRONIC CONTROL DISPLAY MAY REFLECT THE FLUCTUATING TEMPERATURES OF THE REFRIGERATION CYCLE, NOT THE PRODUCT TEMPERATURE. THE MOST ACCURATE METHOD TO DETERMINE AN APPLIANCE'S OPERATION IS TO VERIFY THE PRODUCT TEMPERATURE.

USER INTERFACE

SET POINT MENU

ICE MENU

MODE MENU

SERVICE REPORT

LIGHT MENU

DOOR AJAR ALARM

SHOWROOM MODE

SYSTEM NOTIFICATIONS



PRESERVE THE MOMENT®

# ELECTRONIC CONTROL OPERATION

## USER INTERFACE

All units are shipped in **ON** mode. During the initial startup, the unit runs a short power up diagnostic followed by a single audible beep. The lights turn on and temperature readings appear on the display.



**WARNING!** Turning the unit off with the power button does not remove the power supply from the control. Unplug the unit or turn off the power supply.

Please note that though the display can show either Fahrenheit or Celsius, in most cases the figures show Fahrenheit. Please see the button functions in the diagram below.

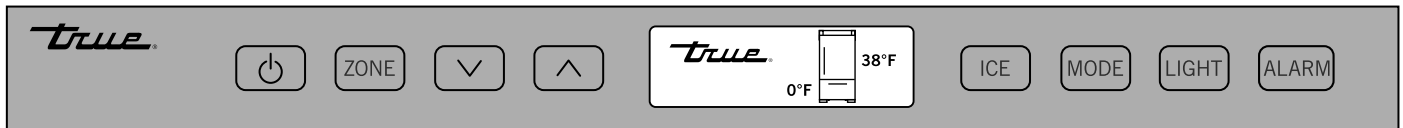

- Unless otherwise stated, the shown button commands are “press and release”.
- Shutting the door exits the menu to the Home screen.

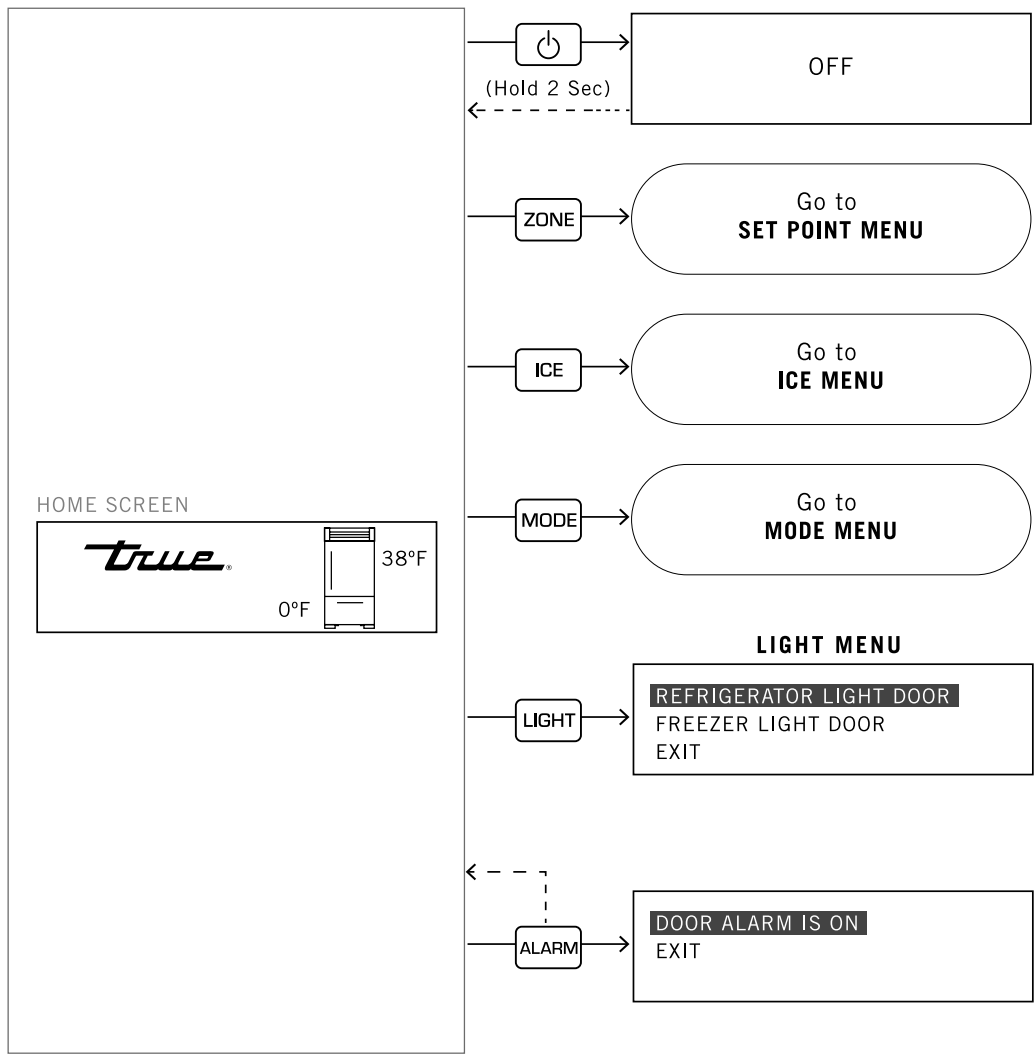

## SET POINT MENU

To adjust set points, please see the information and diagram below.

- Press the **ZONE** button until the display shows the appropriate compartment.
- With the **DOWN** or **UP** arrows, select the desired set point.

**NOTE: EACH BUTTON PRESS ADJUSTS THE SET POINT BY ONE (1) DEGREE AND IS ACCOMPANIED BY AN AUDIBLE BEEP.**

- When the desired set-point is reached, press the **ZONE** button until the display shows the home screen.

### PLEASE NOTE:

- The temperature range in a freezer zone is -4°F (-20°C) to 4°F (-16°C).
- The temperature range in a refrigerator zone is 32°F (0°C) to 42°F (6°C).
- Initial factory set-points are 0°F (-18°C) in a freezer zone and 38°F (3°C) in a refrigerator zone.
- The initial stroke of the up or down key will change the previous set-point by one degree.

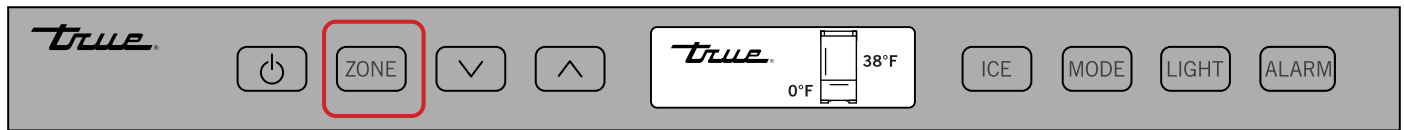

- Unless otherwise stated, the shown button commands are “press and release”.
- Shutting the door exits the menu to the Home screen.

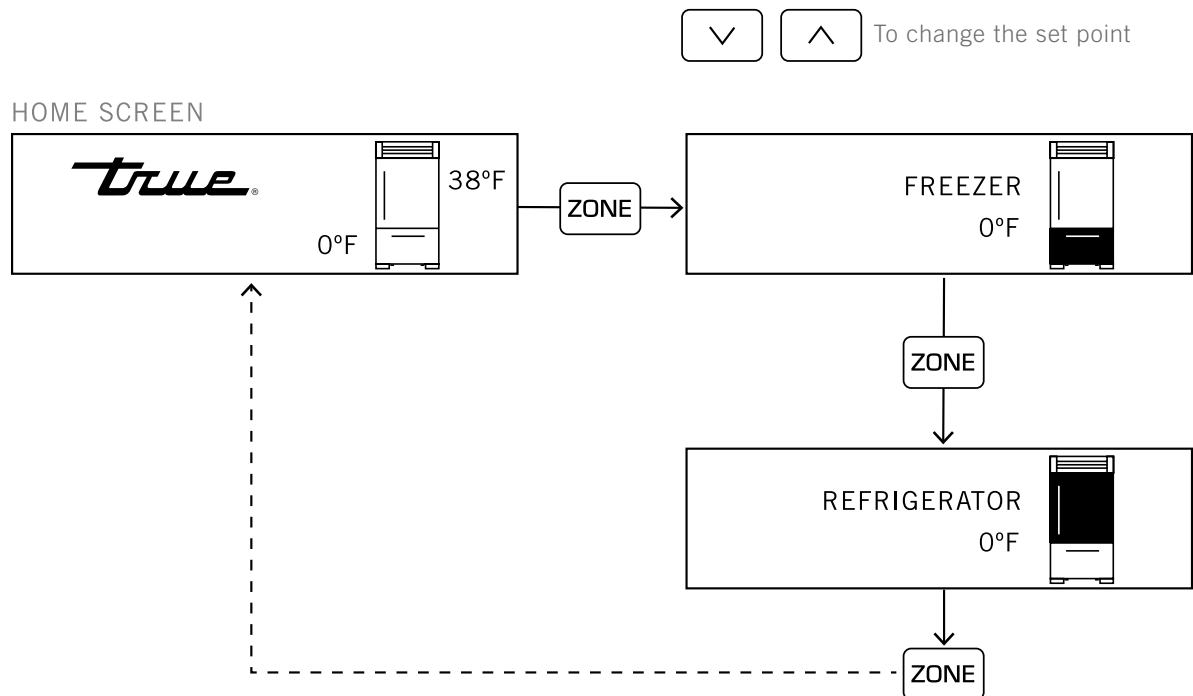

ICE MENU

To enter the Ice Menu, press **ICE** on the user interface. Use the **UP** and **DOWN** arrows to navigate between the menu options and use **ICE** to make a selection. See the diagram below.

The Ice Menu contains three operations.

- Ice Maker: Toggles the icemaker between on/off.
- Max Ice: Maximizes ice production for 24 hours.
- Water Filter Reset: Immediately resets the countdown to change the water filter.

**NOTE: THE WATER FILTER REMINDER WILL APPEAR EVEN IF NO WATER FILTER IS INSTALLED. RESET THE REMINDER PER THE INSTRUCTIONS BELOW.**

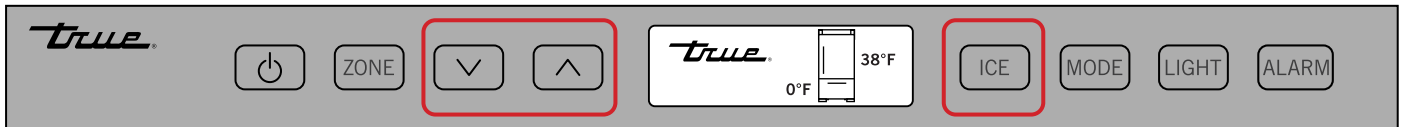

- Unless otherwise stated, the shown button commands are “press and release”.
- Shutting the door exits the menu to the Home screen.

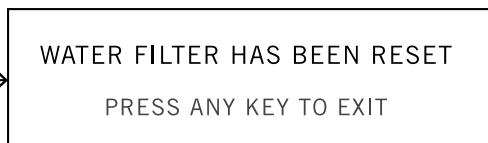
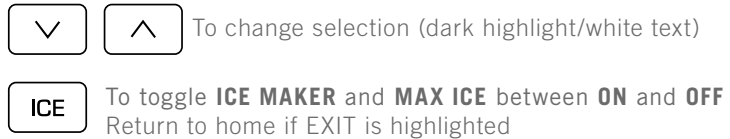

ANY KEY

HOME SCREEN



**ICE TROUBLESHOOTING**

Please see the table below to troubleshoot some common problems with ice production. If your issue is not resolved, please contact True Residential Technical Support at **844-746-9423** or **TrueResidentialService@TrueMfg.com**.

Icemaker Troubleshooting	
<b>No ice</b>	<ul style="list-style-type: none"> <li>• Verify the water filter is installed</li> <li>• Verify water is being supplied to the unit</li> <li>• Verify the icemaker is on at the display and on the icemaker itself (see fig. 1) and has been running for at least 24 hours</li> <li>• Verify the ice bin is positioned correctly</li> <li>• Verify the freezer temperature is near 0°F (-17.8°C)</li> <li>• Verify the water filter has been replaced within the last 12 months and has been installed correctly</li> </ul>
<b>Black flecks in the ice cubes</b>	Stop use and contact True Residential Technical Support
<b>Bad taste</b>	<ul style="list-style-type: none"> <li>• Defrost the freezer and clean with soap and water</li> <li>• Place coffee grounds or charcoal briquettes in the freezer to absorb odor</li> </ul>
<b>Hollow cubes</b>	Clean the condenser coil. Contact True Residential Technical Support if the issue is unresolved.

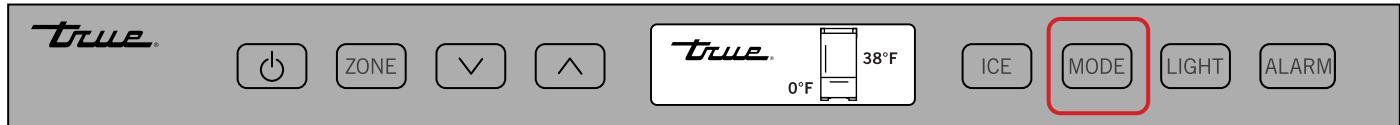

**FIG. 1.** Off/on switch on the bottom of the icemaker near the TRUE logo.

MODE MENU

The MODE menu contains four operations.

- **Holiday Mode:** Star-K compliant. Cannot change set points or initiate manual defrost. **HOLIDAY MODE ACTIVE** shows on the display when the door is closed.
- **Temperature:** Change between Fahrenheit and Celsius. Exit to the home screen to confirm the change.
- **Vacation Mode:** Mode ends when the door opens.
- **Service Report:** Cycles the display through any error notifications.



- Unless otherwise stated, the shown button commands are “press and release”.
- Shutting the door exits the menu to the Home screen.

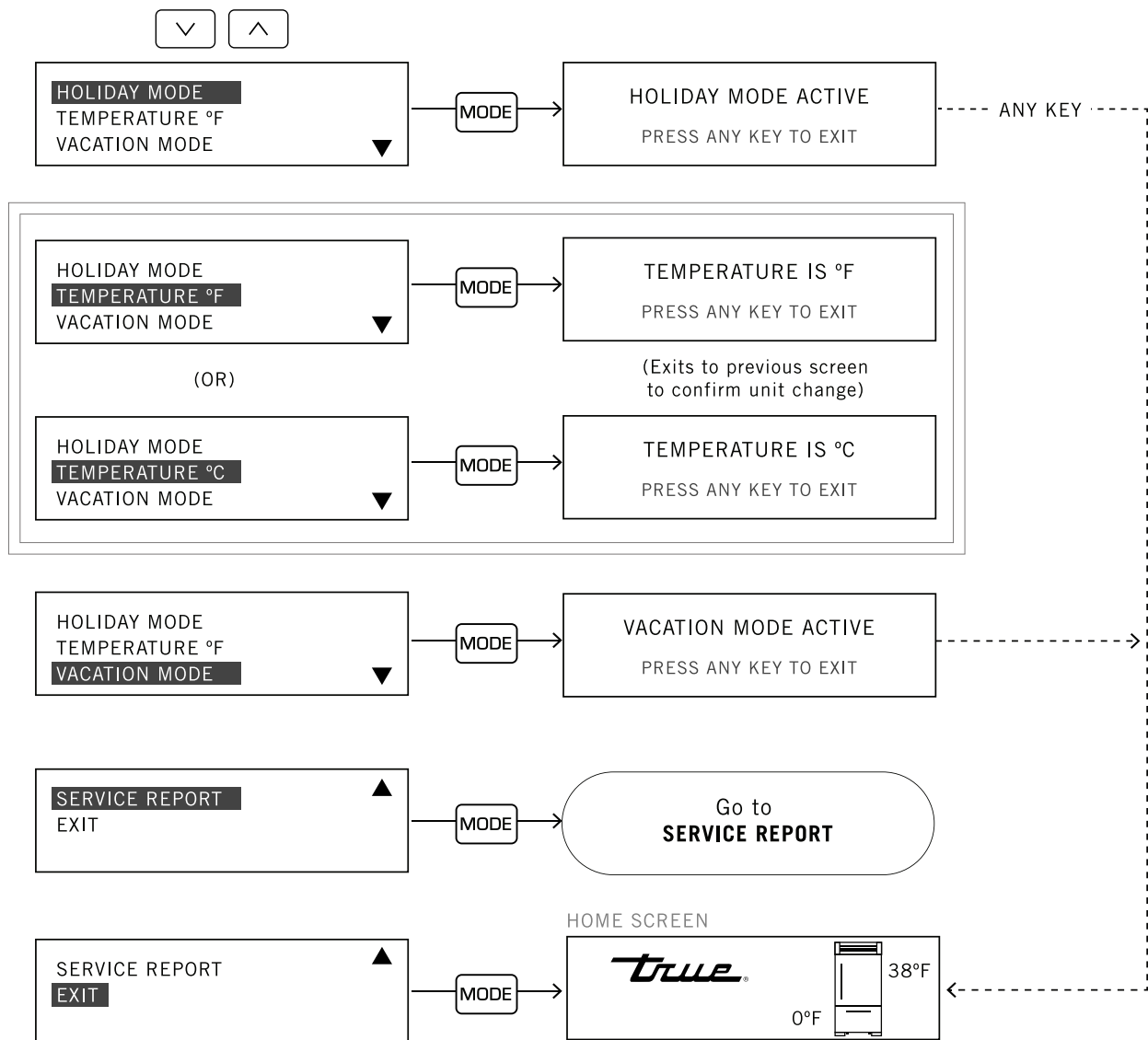

SERVICE REPORT

The service report is for the end user.

IF NO ERRORS

NO SERVICE REQUIRED  
PRESS ANY KEY TO EXIT

(OR)

IF ERRORS EXIST



CALL FOR SERVICE  
FREEZER THERMISTORS ▼

CALL FOR SERVICE  
REFRIGERATOR THERMISTORS ▼

CALL FOR SERVICE  
FREEZER RUN TIME ▼

CALL FOR SERVICE  
REFRIGERATOR RUN TIME ▼

CALL FOR SERVICE  
UNIT IS NON FUNCTIONAL ▼ (Only after  
run time errors)



HOME SCREEN

*True* 38°F  
0°F

ANY KEY

(Display will cycle to all existing errors  
-and bypass nonexistent- before prompting  
the exit screen below))

CYCLE POWER TO RESET ERROR CODES  
PRESS ANY KEY TO EXIT

# ELECTRONIC CONTROL OPERATION

## LIGHT MENU

All models are equipped with an accent lighting system in the refrigerator and/or freezer compartment(s). To energize the accent lighting system, press **LIGHT** and navigate to the corresponding compartment (see diagram below).

- **DOOR:** Lights turn on when the door/drawer opens.
- **ON:** Lights turn on and stay on when the door/drawer closes.

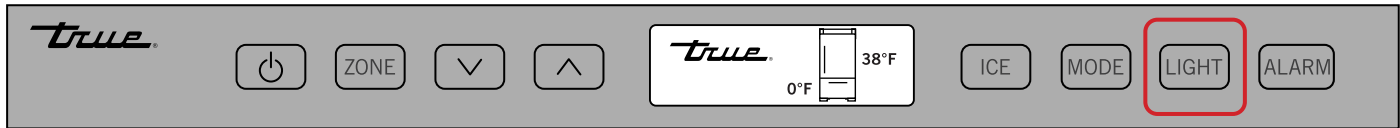

- Unless otherwise stated, the shown button commands are “press and release”.
- Shutting the door exits the menu to the Home screen.

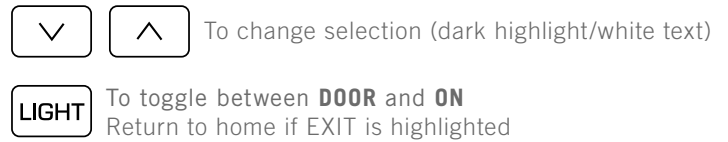

### HOME SCREEN

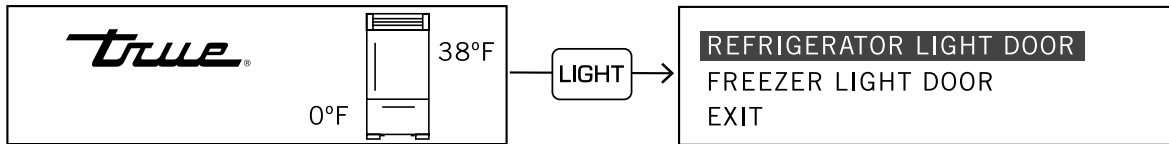

### HOME SCREEN

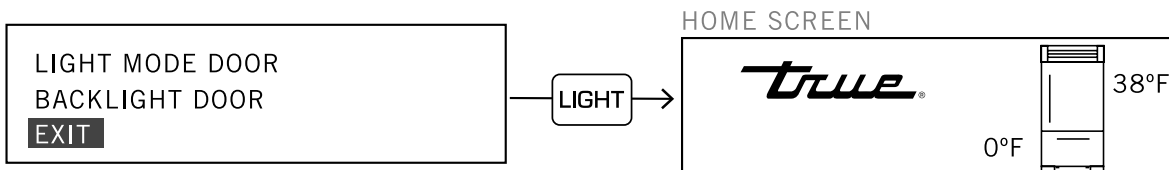
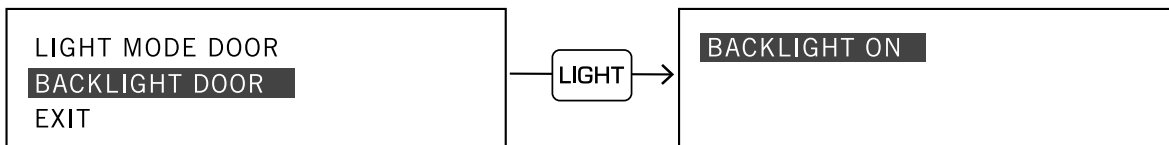
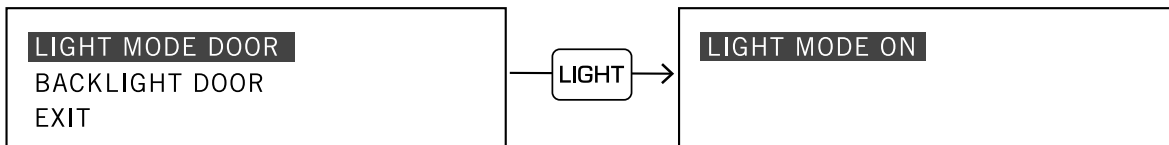
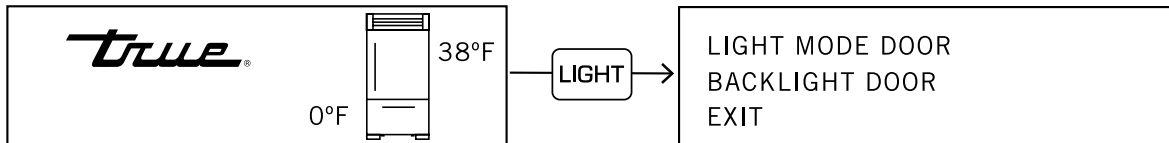

### DOOR AJAR ALARM

The cabinet will alert whenever the door is left ajar.

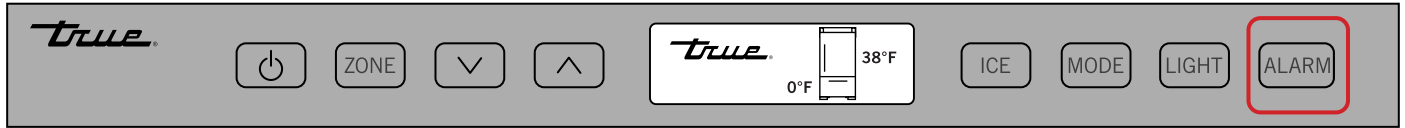

- Unless otherwise stated, the shown button commands are “press and release”.
- Shutting the door exits the menu to the Home screen.

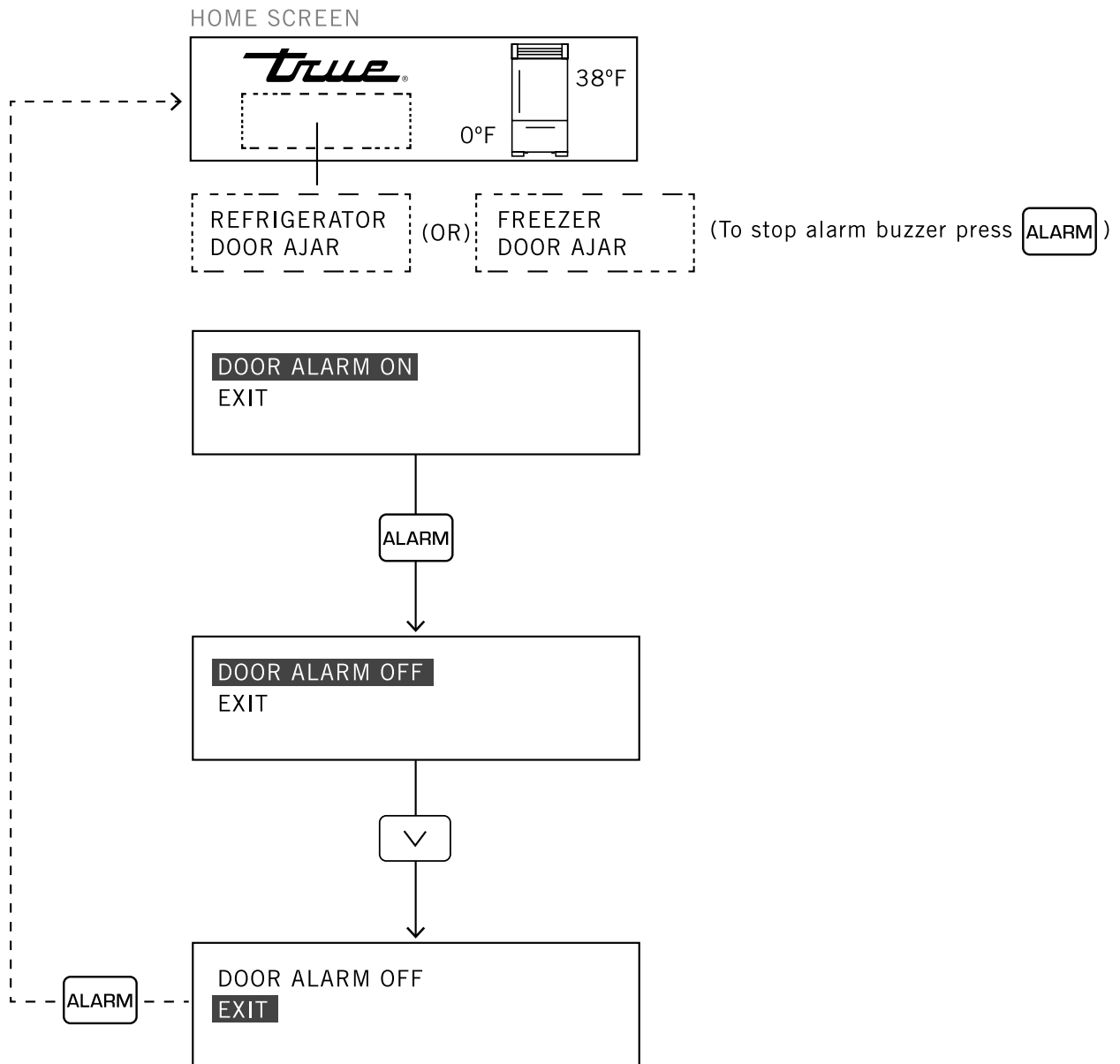

# ELECTRONIC CONTROL OPERATION

## SHOWROOM MODE

Showroom mode (found in the Service Menu) enables all cabinet functions except for refrigeration.

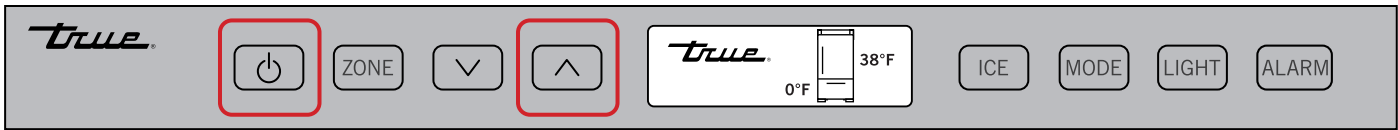

- Unless otherwise stated, the shown button commands are “press and release”.
- Shutting the door exits the menu to the Home screen.

### HOME SCREEN

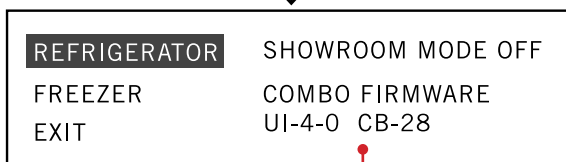
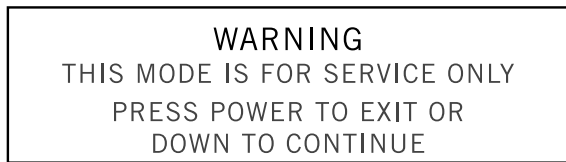
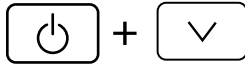

To change selection (dark highlight/white text)



Will enter **REFRIGERATOR/FREEZER SERVICE**, toggle **SHOWROOM MODE ON/OFF** or exit to home. Showroom mode enables all cabinet functions except for refrigeration.

UI-4-0 = USER INTERFACE FIRMWARE VERSION  
CB-28 = CONTROL BOARD FIRMWARE VERSION

SYSTEM NOTIFICATIONS

- The display may show the notifications in the table below if the appliance requires attention.
- Multiple notifications will cycle through each one for 5 seconds

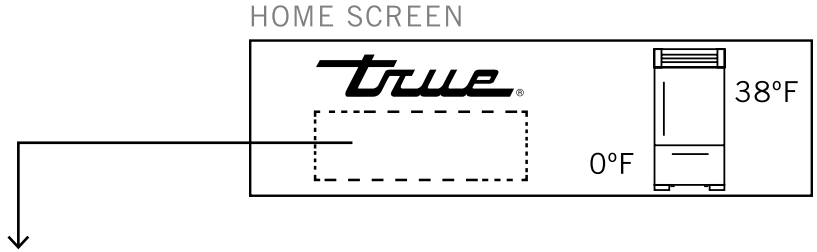

NOTIFICATION	DEFINITION	ALARM SOUNDS	NOTIFICATION CLEARED BY:
REFRIGERATOR HIGH TEMP	Zone temperature is above high temperature alarm.	YES	Zone is below high temperature alarm.
FREEZER HIGH TEMP	Zone temperature is above high temperature alarm.	YES	Zone is below high temperature alarm.
REFRIGERATOR DOOR ALARM	Door alarm has been triggered (door open for 5 minutes).	YES	Door alarm has been cleared.
FREEZER DOOR ALARM	Door alarm has been triggered (door open for 5 minutes).	YES	Door alarm has been cleared.
SHOWROOM MODE	Unit in showroom mode (see service mode menu). Only the light features are active and set point temperatures are displayed.	NO	Exit showroom mode (see service mode menu).
REMOTE CONNECTION	Control is being accessed remotely via communication cable or bluetooth.	NO	Control is no longer being remotely accessed.
WATER FILTER	Water filter timer expired.	NO	Water filter reset in Ice Menu.



INTERIOR ACCESSORIES

DOOR REMOVAL

APPLIANCE CARE & CLEANING

WATER FILTER REPLACEMENT

CONDENSER COIL CLEANING

CONDENSATION

HANDLE TIGHTENING

SERIAL LABEL LOCATION

CONTACT INFORMATION

COMPONENT REPLACEMENT



PRESERVE THE MOMENT®

## INTERIOR ACCESSORIES

All removable interior accessories are dishwasher safe.

## DOOR REMOVAL



**WARNING!** Sharp edges. Take care when installing, cleaning, servicing, and maintaining the equipment.

**NOTE: IF THE APPLIANCE IS EQUIPPED WITH A 90° DOORSTOP, OPEN/HOLD THE DOOR 45° FROM THE OPENING.**

### REMOVAL

1. Open the rainshield. See fig. 1.
2. Remove the hinge covers. See fig. 2.
3. Open the door 90°.
4. Carefully lift the door from the hinge bases. See fig 3.

**NOTE: DO NOT LIFT THE DOOR BY THE HANDLE.**

### INSTALLATION

1. Open the rainshield. See fig. 1.
2. Hold the door 90° to the door opening. See fig. 3.

**NOTE: DO NOT LIFT THE DOOR BY THE HANDLE.**

3. Align the hinge posts with the hinge bases. Then, lower the door into place.
4. Reinstall the hinge covers.
5. Close the rainshield.

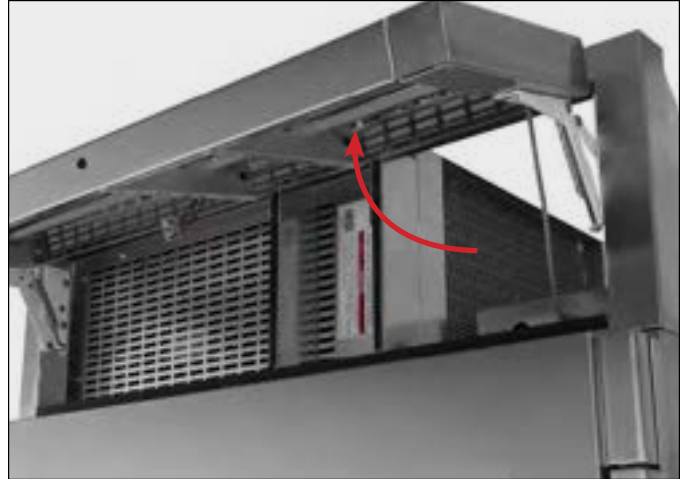

FIG. 1. Open the rainshield.



FIG. 2. Remove the hinge covers.

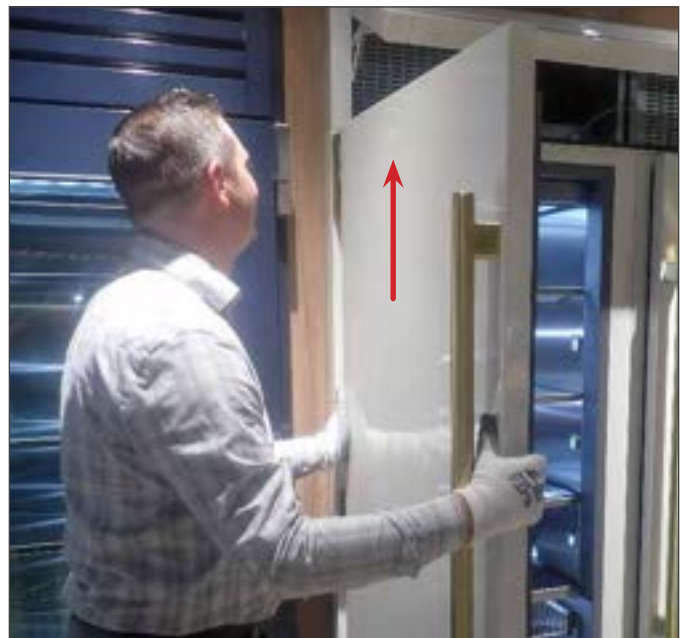

FIG. 3. Remove the door.

APPLIANCE CARE & CLEANING



**CAUTION: DO NOT USE ANY STEEL WOOL, ABRASIVE OR CHLORINE BASED PRODUCTS TO CLEAN STAINLESS STEEL SURFACES.**

**STAINLESS STEEL OPPONENTS**

There are three basic things which can break down your stainless steel’s passivity layer and allow corrosion to form.

- Scratches from wire brushes, scrapers, and steel pads are just a few examples of items that can be abrasive to stainless steel’s surface.
- Deposits left on your stainless steel can leave spots. You may have hard or soft water depending on what part of the country you live in. Hard water can leave spots. Hard water that is heated can leave deposits if left to sit too long. These deposits can cause the passive layer to break down and rust your stainless steel. All deposits left from food prep or service should be removed as soon as possible.
- Chlorides are present in table salt, food, and water. Household and industrial cleaners are the worst type of chlorides to use.

**STAINLESS STEEL CLEANING AND RESTORATION**

Stainless steel cleaners must be free of phosphates, chlorine, chloride, and ammonia.

TRUE offers environmentally-friendly cleaner and polish through our True Store at <https://store.trueresidential.com/products/stainless-steel-clean-polish-kit>

**CUSTOM PAINTED APPLIANCES AND HARDWARE**

For painted doors and other surfaces, use a mild solution of soap and water with a soft microfiber cloth.

## APPLIANCE CARE &amp; CLEANING

**8 TIPS TO HELP PREVENT RUST ON STAINLESS STEEL**

- **Maintain the Cleanliness of Your Equipment** – Avoid build-up of hard stains by cleaning frequently. Use cleaners at the recommended strength (alkaline chlorinated or non-chloride).
- **Use the Correct Cleaning Tools** – Use non-abrasive tools when cleaning your stainless steel products. The stainless steel's passive layer will not be harmed by soft cloths and plastic scouring pads.
- **Clean Along Polishing Lines** – Polishing lines ("grain") are visible on some stainless steels. Always scrub parallel to polishing lines when visible. Use a plastic scouring pad or soft cloth when you cannot see the grain.
- **Use Alkaline, Alkaline-Chlorinated or Non-Chloride Cleaners** – While many traditional cleaners are loaded with chlorides, the industry is providing an ever increasing choice of non-chloride cleaners. If you are not sure of your cleaner's chloride content, contact your cleaner supplier. If they tell you that your present cleaner contains chlorides, ask if they have an alternative. Avoid cleaners containing quaternary salts, as they can attack stainless steel, causing pitting and rusting.
- **Rinse** – When using chlorinated cleaners, you must rinse and wipe dry immediately. It is better to wipe standing cleaning agents and water as soon as possible. Allow the stainless steel equipment to air dry. Oxygen helps maintain the passivity film on stainless steel.
- **Never Use Hydrochloric Acid (Muriatic Acid) on Stainless Steel** – Even diluted, hydrochloric acid can cause corrosion, pitting and stress corrosion cracking of stainless steel.
- **Water Treatment** – To reduce deposits, soften hard water when possible. Installation of certain filters can remove corrosive and distasteful elements. Salts in a properly maintained water softener can also be to your advantage. Contact a treatment specialist if you are not sure of the proper water treatment.
- **Regularly Restore & Passivate Stainless Steel** – Stainless steel gets its stainless properties from the protective chromium oxides on its surface. If these oxides are removed by scouring, or by reaction with harmful chemicals, then the iron in the steel is exposed and can begin to oxidize, or rust. Passivation is a chemical process that removes free iron and other contaminants from the surface of stainless steel, allowing the protective chromium oxides to re-form.

WATER FILTER REPLACEMENT (OPTIONAL ICEMAKER ONLY)



**WARNING!** Sharp edges! Take care when moving, installing, cleaning, servicing, and maintaining the appliance to avoid cuts. Be sure to take care when reaching under the appliance or handling metal components. Gloves recommended.



**WARNING! CHOKING HAZARD!**  
Small parts. Keep away from children under 8 years.



**NOTE: BEFORE CONSUMING ICE, DISCARD THE FIRST FULL BIN OF ICE (48 HOURS). THIS FLUSHES THE SYSTEM OF IMPURITIES.**

The water filter has a life expectancy of 300 gal (1,136 L) or six months. When the water filter reaches the end of its life, the control display shows **WATER FILTER**.

To order a replacement water filter, go to: [store.trueresidential.com/collections/maintenance-1/products/full-size-models-replacement-water-filter](https://store.trueresidential.com/collections/maintenance-1/products/full-size-models-replacement-water-filter) or contact our parts department at **844-849-6226** or [TrueResidentialParts@TrueMfg.com](mailto:TrueResidentialParts@TrueMfg.com).

**NOTE: WATER FILTER NOTIFICATIONS STILL OCCUR EVEN IF THE WATER FILTER IS NOT INSTALLED.**

**PROCEDURE**

1. Remove the kickplate. See fig. 1.
2. Rotate the water filter counterclockwise (see fig. 2) until the handle arrows (see fig. 3) are vertical. Pull the water filter from the filter receptacle.

**NOTE: RESIDUAL WATER MAY BE PRESENT. CLEAN ANY WATER SPILLS IMMEDIATELY.**

3. Locate the replacement water filter.
4. Remove the outer packaging and water filter cap. See fig. 4.
5. Inspect the water filter head and o-rings for damage. See fig. 5.
6. With the handle arrows vertical, insert the water filter into the filter receptacle. See fig. 6.
7. Rotate the water filter clockwise until the filter stops turning. See fig. 6 and 7.

**NOTE: THE HANDLE ARROWS SHOULD BE SLIGHTLY BEYOND HORIZONTAL. SEE FIG. 7.**

8. Press and hold the test button\* on the icemaker (see fig. 8) for 5-10 sec. Then, check the water filter area for leaks. If leaks are detected, repeat step 7.

**NOTE: BE SURE THE ICE BIN IS IN PLACE TO CATCH THE TRAY CONTENTS.**

9. Reinstall the kickplate.
10. Reset the filter reminder per “Ice Menu Navigation” (pg. 61).
11. Before consuming ice, discard the first full bin of ice (48 hours). This flushes the system of impurities.

\*The test button cycles the icemaker. The ice tray will fill with water. Please note if the button is pressed and held multiple times, the tray will empty into the appliance. Make sure the ice bin is in place to catch the tray contents.

WATER FILTER REPLACEMENT (OPTIONAL ICEMAKER ONLY) (CONT.)

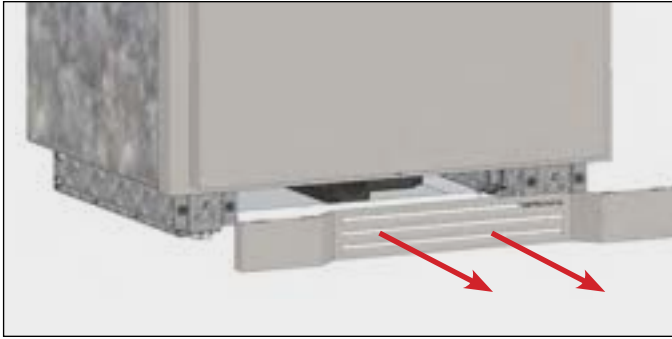

FIG. 1. Pull the kickplate from the cabinet.

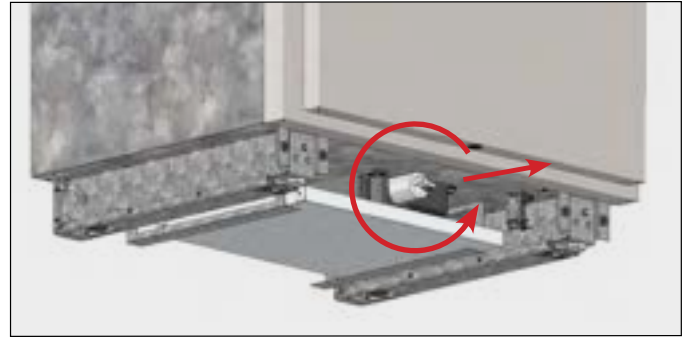

FIG. 2. Rotate the existing water filter counterclockwise.

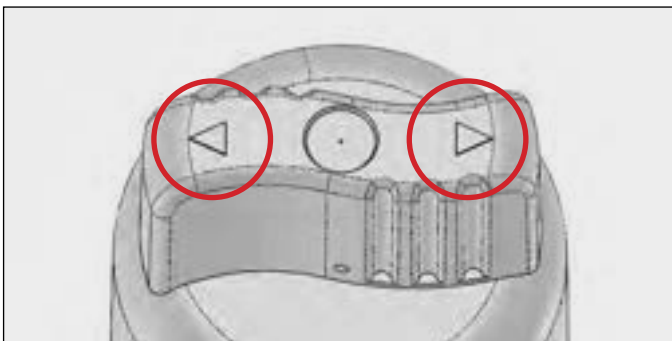

FIG. 3. Water filter handle arrow locations.



FIG. 4. Sanitary cap over water filter head.



FIG. 5. Undamaged water filter head (A) vs. a damaged water filter head (B).



FIG. 6. Insert the water filter and rotate it clockwise.

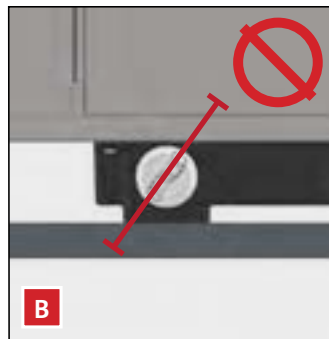
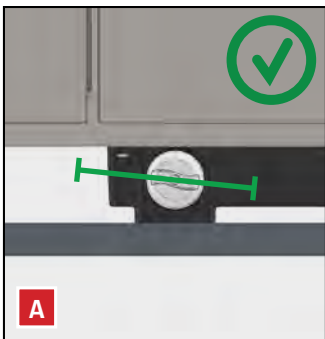

FIG. 7. Correct install (A) vs. incorrect install (B).



FIG. 8. Test button located on underside of icemaker by TRUE logo.

## CONDENSER COIL CLEANING

Keeping the condenser coil clean minimizes required servicing and lowers electrical cost. Warranty does not cover cleaning the condenser coil.



**WARNING!** Electrical shock or burn hazard. Unplug the unit or turn off the power supply before proceeding.  
**DO NOT** clean appliance with a pressure washer or hose.



**CAUTION!** Risk of eye injury from debris. Eye protection is recommended.



**CAUTION!** Coil fins are sharp. Gloves are recommended.

### REQUIRED TOOLS

- Stiff-bristled brush
- Vacuum Cleaner
- Gloves (recommended)

### PROCEDURE

1. Open the rainshield. See fig. 1.
2. With a stiff-bristled brush, carefully clean accumulated dirt from the condenser coil fins. See fig. 2.

**NOTE: NEVER BRUSH ACROSS THE COIL FINS.**

3. Carefully vacuum any dirt around the condensing unit area.
4. Close the rainshield.

## CONDENSATION

Leaving the doors and/or drawers open for long periods of time or running a unit with little/no product inside may cause excessive condensation.



FIG. 1. Opened rainshield.

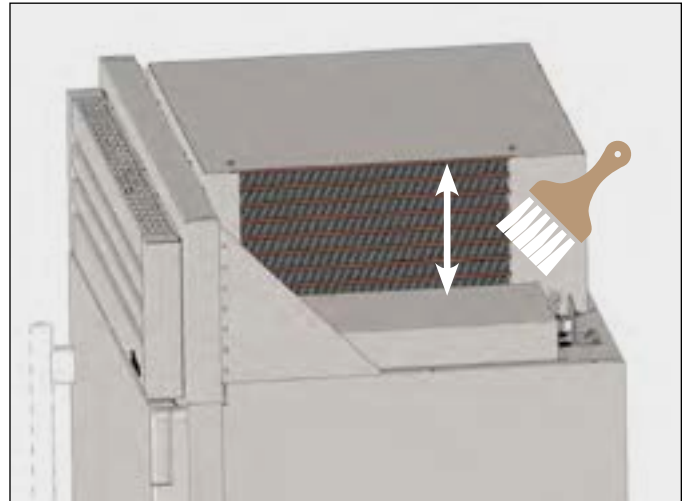

FIG. 2. Never brush across coil fins.

## HANDLE TIGHTENING

---

Tighten handles with a 3/32" Allen wrench.

## SERIAL LABEL LOCATION

---

The serial label is located on the upper right wall of the freezer drawer. See fig. 1.

This label contains important information such as your model name and serial number. Please have this information on hand when contacting True so we can better assist you with your service- or parts-related inquiries.



FIG. 1. Serial label location.

## CONTACT INFORMATION

---

### CUSTOMER SERVICE

Phone: 888-616-8783  
info@true-residential.com

### WARRANTY DEPARTMENT

Phone: 844-849-6179  
TrueResidentialWarranty@truemfg.com

### TECHNICAL SUPPORT DEPARTMENT

Phone: 844-746-9423  
TrueResidentialService@truemfg.com

## COMPONENT REPLACEMENT

---

- Replace components with original equipment manufacturer (OEM) components. OEM parts minimize the risk of possible ignition due to incorrect parts. Use of non-OEM components may void TRUE's warranty.
- Have a licensed service provider service your unit to minimize the risk of possible ignition due to incorrect parts or improper service and to ensure the operator's health and safety.

TO VIEW AND DOWNLOAD THE WARRANTY INFORMATION  
FOR USA & CANADA, PLEASE SCAN THE QR CODE BELOW.







## CONTACT US

[true-residential.com](http://true-residential.com)

636.240.2400 | toll free 888.616.8783



PRESERVE THE MOMENT®



BP\_230225\_07.24