



# Beyond Audio, **HiFi ROSE**

Absolute True Fidelity DAC **RD160**



rose





## Absolute True Fidelity DAC RD160

- ROSE DPC™ (Digital Processing Core) Module
- ROSE CIM™ (Completely Isolated & Moduled) Architecture
- Three Independently Customized Reference Linear Power Supply Units
- ROSE NRA™ (Noise Reduction Analog) Filter for Flat and Wide Frequency Response
- High-Precision OCXO Clock for Long-Term Jitter Reduction
- Lavish Internal Wiring with High-Purity OFC and OCC
- Fiber Optic USB Connectivity

Hi-Res	DSD	Native DSD 512
	PCM	32bit/768kHz
In/Out Port	Digital In	USB SFP, USB 2.0 B-Type, Optical, Coaxial 1(RCA), Coaxial 2(BNC), AES/EBU, I2S-HDMI
	Analog Out	Unbalanced, Balanced
	Clock In	BNC 75Ω, SMA 50Ω

**Design** 430\*330\*88 mm / 10 kg / Solid Aluminum, Rust-proof Steel / Color: Black, Silver



## Top-notch Master Integrated Amplifier RA280

- Class AD Amplifier with Next-Generation GaN FET
- Independently Developed LC Filter by HiFi ROSE
- Highly Efficient and Stable Power Supply
- Powerful 250W Output
- Phono Amplifier for MM
- Bass/Treble Control Volume

In/Out Port	Analog In	LINE1, LINE2, LINE3, BALANCED, PHONO(MM)
	Analog Out	Sub Woofer
Speaker Out	Stereo	250W x 2ch(4Ω, 8Ω)

**Design** 430\*355\*110 mm / 9.5 kg / Solid Aluminum, Rust-proof Steel / Color: Black, Silver



# Ultimate Network Transport RS130

- Linear Power Supply Utilizing Supercapacitor for Battery-Level Noise Reduction
- High-Precision OCXO Clock for Long-Term Jitter Reduction
- External Master Clock Input
- Network Streaming with SSD Caching Playback
- Fiber Optic Ethernet & USB Connectivity

Hi-Res	DSD	Native DSD 512	Network Connection	Ethernet	10/100/1000 BASE-T (SFP COPPER Type)
	PCM	32bit/768kHz			
In/Out Port	Digital Out	USB 2.0 Type-A, Optical, Coaxial, AES/EBU, I2S-HDMI		Wi-Fi	USB Dongle
	Clock In	BNC 75Ω, 50Ω		Bluetooth	USB Dongle V.4.2
	HDMI Out	4K			

**Connectivity** Bluetooth, DLNA, Airplay, Spotify Connect, Roon Ready

**Design** 430\*317\*125 mm / 12 kg / 15.4" Wide viewing angle touch screen / Color: Black, Silver



# Advanced All-In-One Network Streamer RS520

- Reference Grade Network Streaming All-in-One
- Network Transport + DAC + Class AD Amplifier with Next-Generation GaN FET
- High-Resolution Music Playback (DSD512, PCM 32bit/768kHz)
- Highly Precise Femto Clock
- Linear Power Supply for Significant Noise Reduction

Hi-Res	DSD	Native DSD 512	In/Out Port	HDMI Out	4K
	PCM	32bit/768kHz		Speaker Out	250W x 2ch(4Ω, 8Ω)
In/Out Port	Digital In	USB 2.0 Type-B, Optical, Coaxial, HDMI eARC	Network Connection	Ethernet	10/100/1000 BASE-T
	Digital Out	USB 3.0 Type-A, Optical, Coaxial		Wi-Fi	USB Dongle
	Analog In	Line In		Bluetooth	USB Dongle V.4.2
	Analog Out	Unbalanced			

**Connectivity** Bluetooth, DLNA, Airplay, Spotify Connect, Roon Ready

**Design** 346\*328\*127 mm / 8.1 kg / 12.6" Wide viewing angle touch screen / Color: Black, Silver



## Absolute Pure Sound Integrated Amplifier RA180

- Class AD Amplifier with Next-Generation GaN FET
- Multi-Output Component
- Designed to Play Up to the Super Tweeter Realm
- Balanced Power Supply
- Phono Amplifier with Variable EQ

In/Out Port	Analog In	LINE1, LINE2, LINE3(Bypass), BALANCED, PHONO(MM/MC)
	Analog Out	Sub Woofer
Speaker Out	Stereo(A/B)	200W x 4ch(8Ω)
	Stereo(A), BTL(B)	Stereo(A): 200W x 4ch(8Ω) / BTL(B): 400W x 2ch(8Ω)
	BTL(A/B)	BTL(A): 400W x 2ch(8Ω) / BTL(B): 400W x 2ch(8Ω)

**Design** 430\*391\*124 mm / 16.7 kg / Solid Aluminum, Rust-proof Steel / Color: Silver



## High Performance Network Streamer RS150B

- Flagship Network Streamer
- Network Transport + DAC
- Advanced DAC Design for Pure Sound with Low Noise and Distortion
- High-Resolution Music Playback (DSD512, PCM 32bit/768kHz)
- Highly Precise Femto Clock
- Linear Power Supply for Significant Noise Reduction

Hi-Res	DSD	Native DSD 512	In/Out Port	Analog In	Line In
	PCM	32bit/768kHz		Analog Out	Unbalanced, Balanced
In/Out Port	Digital In	USB 2.0 Type-B, Optical, Coaxial, AES/EBU, HDMI ARC	Network Connection	HDMI Out	4K
				Ethernet	10/100/1000 BASE-T
	Digital Out	USB 3.0 Type-A, Optical, Coaxial, AES/EBU, I2S-DVI, I2S-RJ45		Wi-Fi	USB Dongle
				Bluetooth	USB Dongle V.4.2

**Connectivity** Bluetooth, DLNA, Airplay, Spotify Connect, Roon Ready

**Design** 430\*318\*124 mm / 11 kg / 14.9" Wide viewing angle touch screen / Color: Black, Silver



## Complete HiFi Network Streamer RS250A

- Reference Grade Network Streamer
- Network Transport + DAC
- High-Resolution Music Playback (DSD512, PCM 32bit/768kHz)
- Highly Precise Femto Clock
- Linear Power Supply for Significant Noise Reduction

Hi-Res	DSD	Native DSD 512	In/Out Port	HDMI Out	4K
	PCM	32bit/768kHz		Headphone Out	3.5mm
In/Out Port	Digital In	USB 2.0 Type-B, Optical, Coaxial	Network Connection	Ethernet	10/100/1000 BASE-T
	Digital Out	USB 3.0 Type-A, Optical, Coaxial		Wi-Fi	802.11 a/b/g/n/ac (2.4GHz/5GHz)
	Analog In	Line In		Bluetooth	V4.0 / V3.0+HS
	Analog Out	Unbalanced			

**Connectivity** Bluetooth, DLNA, Airplay, Spotify Connect, Roon Ready

**Design** 278\*231\*83 mm / 3.2 kg / 8.8" Wide viewing angle touch screen / Color: Black, Silver



## HiFi ROSE USB Fiber Optical Hub RSA720

- Compact Design Maximizing Usability and Functionality
- Optical USB Port
- Supports USB 3.0/2.0 via Four Independent USB Ports
- Guaranteed Stable Data Transmission Speed
- Supports Long-Distance Transmission

**Input** USB 3.0 Type-B, SFP(10G)

**Output** USB 3.0-2ports, USB 2.0-2ports

**Design** 152\*153.5\*33.5 mm / 1.2 kg / Color: Silver



## HiFi ROSE CD Drive RSA780 Series

- USB Isolator Adopted to Block Motion Noise
- USB B-Type Port for HiFi Audio
- 900g Weight for Stable CD Playback
- Minimized Motion Noise with Insulators
- CD Ripping Features Included

**Rear** USB Type-B

**Design** 152\*152\*25 mm / 0.9 kg / Color: Silver



# Innovative ROSE OS System



## TIDAL

Enjoy music streaming and videos with TIDAL's unique features. Supports MQA Full Decoder, so you can enjoy high-resolution music.



## ROSE Tube

You can enjoy all content and music on YouTube.



## Spotify Connect

Spotify Connect allows you to play and wirelessly control Spotify music on your ROSE OS over a network. With the Spotify Connect function, you can enjoy a variety of music with HiFi sound quality on your ROSE device.



## Roon Ready

ROSE OS is fully compatible with Roon Core, with Roon Ready certification in compliance with all requirements of Roon Labs. You can enjoy HiFi sound quality on your ROSE device with the powerful music management capabilities of Roon.



## Hi-Res Audio

HiFi ROSE devices are certified with a 'High-Resolution Audio' license from the JAS (Japan Audio Society).



## 4K Video

You can enjoy high-definition videos on YouTube, TIDAL, and Bugs, and play video files in various formats.



## Play CD

Play CDs by connecting an external USB CD-ROM.



## CD Ripping

Rip CDs by connecting an external USB CD-ROM and save them on a storage device.



## Qobuz

Enjoy music streaming with Qobuz's various functions. Support for Hi-Res Audio(24bit/192kHz) means you can enjoy high-resolution music.



## Apple Music App

Enjoy curated playlists divided by Apple Music's own musical tastes. You can enjoy various tracks in Apple Music.



## Audirvana

Enjoy the immersive world of high-resolution music with Audirvana. You can experience the depth of your favorite tracks.



## ROSE Radio

Enjoy Rose Radio, which consists of about 30,000 radio channels from 200 countries around the world. Channels are organized into various categories, and you can easily search for channels with filters of genre/region/language.



## File Manager

You can perform file and folder management tasks, such as moving, copying, and deleting, on storage device.



## MQA

Supports MQA's Full Decoder. Enjoy studio mastering sound quality.



## Clock

Various design clock functions are provided, such as alarms and weather information.



## Music Library

Manage your music files under various categories, such as albums, artists, and genres.



## My Playlist

Create your own playlist. You can also register your friends and share it with them.

# ROSE Connect Remote Application

A dedicated Remote App is provided that allows users to conveniently control and smartly manage their ROSE device. The Remote App is supported on various platforms, including the iPhone, iPad, Android phone, and PCs.

## Control

You can freely and conveniently control various HiFi ROSE functions wirelessly.

**Control** You can control a variety of functions remotely including Music, ROSE Tube, TIDAL, Qobuz, Bugs, Radio, Apple Music and CD Ripping.

**Remote** ROSE Connect includes the remote control function.

**Search** You can conveniently search for a variety of music in the Media Library.

## Streaming

You can simply and easily play music stored on your phone on your ROSE device. Enjoy a lossless, high-quality streaming service.

## Playlist

You can create your own playlist.

Make a playlist on Music and ROSE Tube and check it out at Home - My Music.

## Share with Friends

You can share your playlists with your friends or listen to music recommended by them. Communicate with your friends through music.

## Media Library

Scan the music in your local memory to organize it into various categories.

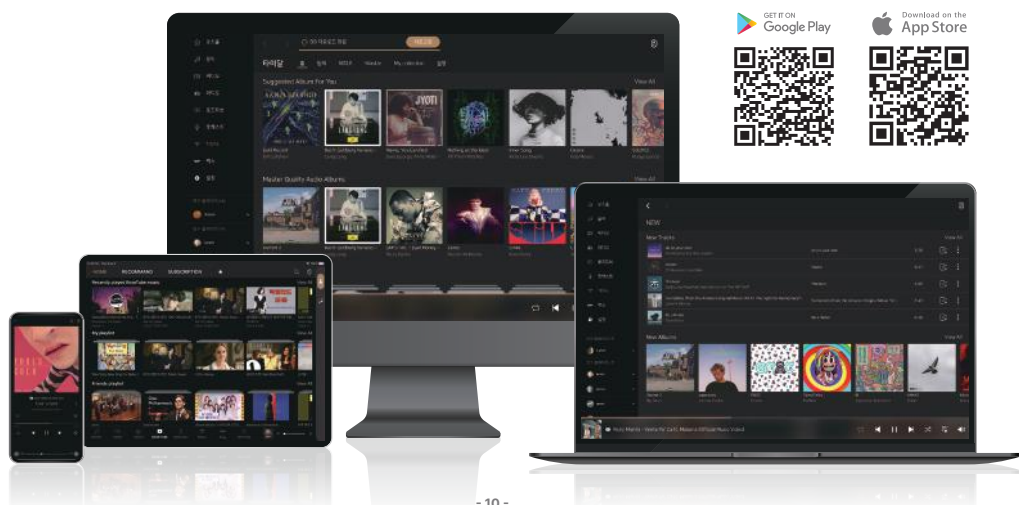

# **OWNER'S MANUAL**

RD160 Product User Manual

# Table of Contents

<b>Safety Precautions</b>	14
1. Warnings	14
2. Precautions	15
<b>Components List</b>	16
<b>Location / Function of Buttons and Ports</b>	17
1. Front Side of the Product	17
1-1. Volume Control Function	
1-1-1. VOLUME	
1-1-2. MUTE	
1-1-3. Pre-Out Level Settings	
1-2. Input Source Switching	
1-3. D/A Converter Settings	
1-3-1. FILTER	
1-3-2. SAMPLING	
1-3-3. CLOCK INPUT	
1-4. System Settings	
1-4-1. DIMMING	
1-4-2. DISPLAY MODE	
2. Rear Side of the Product	22
3. Remote Control	23
<b>Product Installation</b>	24
1. Product Design Method and Recommended Installation Location	24
2. How to Connect the Power Cord	25
3. How to Properly Connect Rear Ports and Cables	26
3-1. Connection Between Analog Output Port and Amplifier or AV Receiver	
3-2. Connection Between Digital Input Port and Audio Device (TV or Devices That Provide Digital Output Capabilities)	
3-2-1. OPTICAL/COAX,1,2	
3-2-2. AES/EBU	
3-2-3. I2S IN	
3-3. PC AUDIO Connection	
3-4. SFP AUDIO Connection	
3-5. TRIGGER Input Terminal and Pin out	
3-6. EXT. CLOCK Connection	
3-7. Circuit Breaker	
3-8. GND Connection	

Product Specifications	38
Quality Guaranteed	40

# Safety Precautions

## 1. Warnings

---



1. Do not apply excessive force on the product, throw it, or strike it with sharp objects.
2. Children should only use the product under adult supervision to ensure proper usage.
3. Use within a temperature range of 0°C to 40°C and do not use in hot or humid conditions. Install the product in a well-ventilated area, not an enclosed space. The product may break, corrode, overheat, or catch fire in an environment below 0°C or in a sealed environment with a high temperature, such as a sauna. Moisture or liquid can also damage the surface of the product and its circuit components.
4. Be sure to use a genuine power cable provided by ROSE. Any other cable may cause operational errors or damage (decreased performance) to the product.
5. Do not spill dirt or liquid on the product. It may damage the components and circuits. If the product gets wet, do not turn it on and contact your nearest service center. However, free repairs are not available in this case.
6. Do not connect accessories that are not certified by ROSE to the product.
7. Please install this product at least 1 m (3 ft) away from devices that may cause radio interference (wireless routers, microwave ovens, etc.). Noise may be generated by electromagnetic waves.

## 2. Precautions

---

1. The contents of the owner's manual are described based on the default settings of the product.
2. Some contents of this manual may be changed without prior notice to the user in order to improve product performance.
3. The features and additional services of the product may vary depending on the country, software specifications, and policy changes of the service provider.
4. Do not use chemical solutions (alcohol, thinner, solvents, etc.) or detergent to clean the product. Rubbing the product with a chemical solution can create heat and cause the product to catch fire. When cleaning the product, wipe it with a soft cloth or towel.
5. Do not disassemble, modify or repair the product on your own. If you do, you will no longer qualify for free repairs. If a malfunction occurs because of this, contact an authorized service center for repairs.
6. Only programs provided by the manufacturer are available. Transferring independently created files or user-modified files to the product can cause operational errors or cause serious problems with the product. ROSE is not responsible for any problems that arise in this case.
7. If the touch screen is damaged, do not touch it with your hands. Contact the service center immediately, as it may cause injury.
8. When you're not going to use the product for a long time, be sure to unplug the power plug from the AC outlet. Even after the power has been shut off (manual standby mode), a minimal current remains in the equipment. Remove the plug to prevent power consumption.
9. To ensure trouble-free use, you must first connect the power then turn on the device by pressing the power button on either the remote control or the device itself. You can turn the power off by pressing the same button.
10. After connecting the power plug and turning on the equipment with the power button, it takes about 10 seconds to complete booting, so please wait for a while.
11. The power will automatically turn off if there is no input signal for more than a set time. If the product is turned off, press the power button on the main unit or the remote control to turn it back on and use it again.
12. Do not power on the device within 10 seconds after shutting off the power and entering manual standby mode. Doing so may cause noise.
13. Install the product close to an outlet so that it is easy to remove the plug from the outlet.
14. Do not use the product near water. Do not expose the product to a dripping or splashing environment and do not place objects containing liquids, such as vases, on the device.
15. Do not block the ventilation openings. Install this product according to the product installation and orientation instructions.
16. Unplug the product during lightning storms or when unused for long periods of time.

# Components List

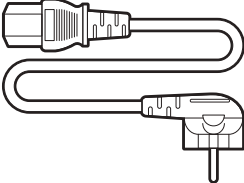
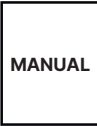
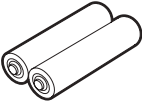
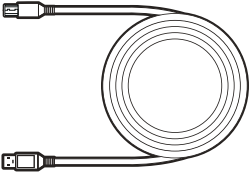
1	Main Device	 A rectangular electronic device with a control panel on the left side featuring several buttons and a power button on the right. It has two feet at the bottom.
2	Remote Control	 A slim, rectangular remote control with a series of buttons and a battery compartment on the right side.
3	Power Cable, 1.8m	 A power cable with a standard three-prong AC power plug on one end and a custom connector on the other.
4	User Manual	 A rectangular box representing the user manual, with the word "MANUAL" printed in the center.
5	AAA Batteries for Remote Control	 Two AAA batteries shown side-by-side.
6	USB Cable Type-B, 1m	 A USB Type-B cable with a standard USB-A connector on one end and a Type-B connector on the other, shown in a coiled configuration.

# Location / Function of Buttons and Ports

## 1. Front Side of the Product



1	<b>FILTER Selector</b>	You can change the filter settings.
2	<b>LED Dimming Switch</b>	You can adjust the brightness of the LED to 6 different levels (including turning the screen off).
3	<b>MUTE</b>	You can enable / disable sound by pressing the Mute button.
4	<b>Power Button (Status Display LED)</b>	When the power button is pressed, the LED blinks, and when booting is complete, the LED turns off. * If there is no input signal for about 20 minutes, the product automatically turns off. If it is turned off automatically, turn it on again with the power button on the main body or the power button on the remote control to use it.
5	<b>Remote Control Receiver</b>	This is the optic receiver part that receives infrared signals from the remote control.
6	<b>INPUT Source Selector</b>	Selects the input of devices connected to each input on the rear side. The input selector is compatible with a total of seven external inputs: AES/EBU, Coaxial, BNC, Optical, I2S, USB, SFP.
7	<b>SAMPLING Selector</b>	You can change the sampling output.
8	<b>CLOCK INPUT</b>	You can change the clock input mode.
9	<b>DISPLAY MODE</b>	You can switch the screen to other modes.
10	<b>Main Volume</b>	You can adjust the volume level by turning it clockwise (+) or counterclockwise (-). Volume can be adjusted from 1 to 100. ⚠ <b>Caution</b> : Please note that listening to music at high volume for a long time may cause hearing damage.

# 1-1. Volume Control Function

- You can connect this product directly to a power amplifier without a preamplifier.
- You can adjust the volume by turning the knob on the right, or mute the sound by pressing the MUTE button.

## 1-1-1. VOLUME

- You can adjust the volume level by turning it clockwise (+) or counterclockwise (-).

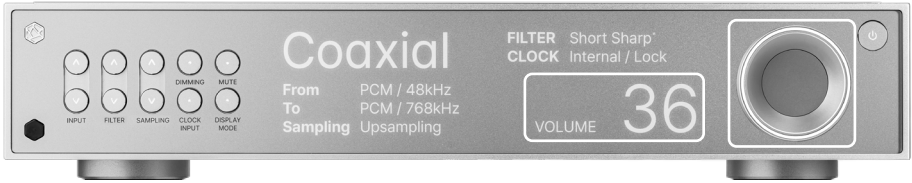

## 1-1-2. MUTE

- You can enable / disable sound by pressing the Mute button.



## 1-1-3. Pre-Out Level Settings

- You can set the pre-out output level from 1V to 9V via the MENU button on the remote control. When setting the output level, the volume control function is disabled.

※ This function can be used by pressing the MENU button on the remote control. (p. 23)



## 1-2. Input Source Switching

- You can change the input source of this product using the functions below.
- Input source settings include AES/EBU, Coaxial, BNC, Optical, I2S, USB, and SFP.



<b>AES/EBU</b>	Inputs a digital signal output from an external device via the XLR terminal.
<b>Coaxial</b>	Inputs a digital signal output from an external device via the Coaxial terminal.
<b>BNC</b>	Inputs a digital signal output from an external device via the BNC terminal.
<b>Optical</b>	Inputs a digital signal output from an external device via the Optical terminal.
<b>I2S</b>	Inputs a digital signal output from an external device via the HDMI terminal.
<b>USB</b>	Inputs a digital signal output from an external device via the USB terminal. ※ To connect PC, you must install the driver on your computer, then convert the audio file. ※ For a detailed description of PC AUDIO, refer to "PC AUDIO Connection". (p. 30)
<b>SFP</b>	Inputs a digital signal output from an external device via the SFP terminal.

## 1-3. D/A Converter Settings

- You can change or adjust the settings of the product using the functions below.

### 1-3-1. FILTER

- You can change the filter settings by pressing up or down.
- You can set the filter to one of six options: Sharp, Slow, Short sharp, Short slow, Super slow, or Low short.



### 1-3-2. SAMPLING

- You can change the sampling output by pressing up or down.
- You can set the sampling to one of four options: Upsampling, To PCM, To DSD, and Bypass.



<b>Upsampling</b>	Increases the resolution of all audio files to their original format.
<b>To PCM</b>	Converts the resolution of the audio file to PCM format.
<b>To DSD</b>	Converts the resolution of the audio file to DSD format.
<b>Bypass</b>	Outputs the audio file in its original resolution.

### 1-3-3. CLOCK INPUT

---

- You can change the clock input mode by pressing the button.
- If you select Internal, which is the default setting mode, the product will be set to internal clock mode. When receiving the master clock input from an external clock generator, you can select EXT. 50Ω or EXT. 75Ω.



### 1-4. System Settings

---

- You can change the settings of the product using the functions below.

#### 1-4-1. DIMMING

---

- You can adjust the brightness of the light on the front of the product to 6 different levels (including turning the screen off) with the buttons.



#### 1-4-2. DISPLAY MODE

---

- You can switch the screen to other modes by pressing the button.



## 2. Rear Side of the Product

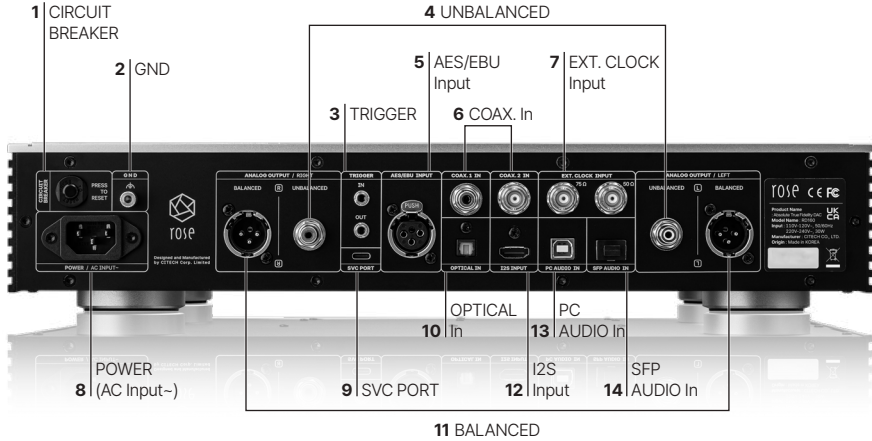

1	<b>CIRCUIT BREAKER</b>	This protection terminal prevents damage to the set due to overvoltage or overcurrent.
2	<b>GND</b>	This port is used to ground the product and external devices.
3	<b>TRIGGER In/Out</b>	This is a function that automatically turns on the set without operation through the remote control when power is supplied from an external device. When you press the power on button on the set, a power control signal is output to the trigger out terminal after the power is stabilized.
4	<b>UNBALANCED Output</b>	Connect the RCA cable to this port to output analog signals.
5	<b>AES/EBU Input</b>	Connect the AES/EBU cable to this port to input digital signals.
6	<b>COAX. Input</b>	Connect the COAXIAL cable to this port to input digital signals.
7	<b>EXT. CLOCK Input</b>	You can connect a 50Ω SMA cable or 75Ω BNC cable to the EXT CLOCK port. You can input an external clock by changing the mode in the input settings.
8	<b>POWER (AC Input-)</b>	Connect the AC power cable here.
9	<b>SVC PORT</b>	This port is used for system updates. (A/S Service Only)
10	<b>OPTICAL Input</b>	Connect the OPTICAL cable to this port to input digital signals.
11	<b>BALANCED Output</b>	Connect the Balanced cable to this port to output analog signals.
12	<b>I2S Input</b>	Connect the HDMI cable to the I2S port to input digital signals.
13	<b>PC AUDIO Input</b>	Connect the USB Type-B cable to this port to input digital signals.
14	<b>SFP AUDIO Input</b>	You can connect an SFP module and an external USB 3.0 fiber hub here with an optical cable.

### 3. Remote Control

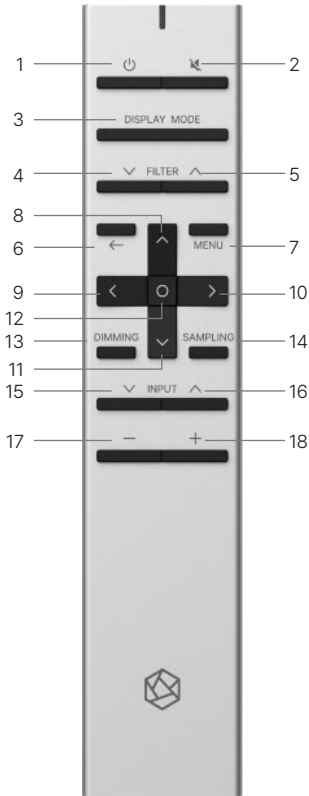

1	<b>Power On/Off</b>	Used to power the set on or off.
2	<b>Mute</b>	Used to mute music.
3	<b>Play / Pause Current Song</b>	
4	<b>Switch to Next Filter</b>	
5	<b>Switch to Previous Filter</b>	
6	<b>Go Back</b>	
7	<b>Menu</b>	
8	<b>Move Focus Up</b>	
9	<b>Move Focus Left</b>	
10	<b>Move Focus Right</b>	
11	<b>Move Focus Down</b>	
12	<b>Select Current Focus</b>	
13	<b>Change LED Brightness</b>	Used to adjust the brightness of the LED to 6 different levels
14	<b>Change Sampling</b>	Used to change the sampling output
15	<b>Switch to Next Input Source</b>	
16	<b>Switch to Previous Input Source</b>	
17	<b>Volume Down</b>	Press and hold to adjust the volume down
18	<b>Volume Up</b>	Press and hold to adjust the volume up

※ This remote control uses infrared (IR) and may malfunction if supplied power decreases. In this case, replace the battery before use.

# Product Installation

## 1. Product Design Method and Recommended Installation Location

- This product is designed to be used on a table or shelf.
- This product can malfunction during cold weather or hot weather.  
(Operating temperature: 0 to 40°C, Storage temperature: -10 to 50°C)
- If the space where the product is installed is small, provide adequate ventilation for the product. A longer operating life is ensured when electronics are properly ventilated and maintained so that they do not overheat more than necessary. Do not install this product directly on a device that generates a lot of heat, such as an amplifier.
- The figure below shows the minimum ventilation requirements required for the product.
- Keep at least 2.5cm apart on each side of this product to prevent airflow from clogging.
- Secure a depth of 40cm for airflow and cabling.

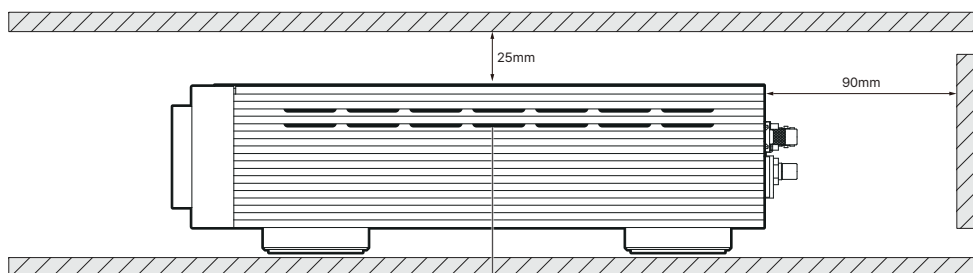
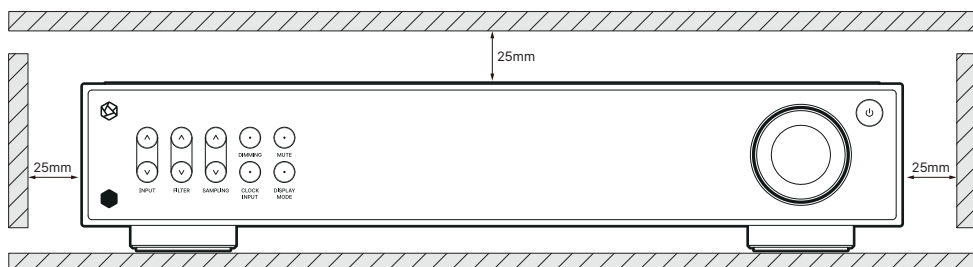

Ventilation Openings  
(Located on both sides of the product)

## 2. How to Connect the Power Cord

---

- This product includes a removable power cord. Please connect the power cord after connecting all audio cables.

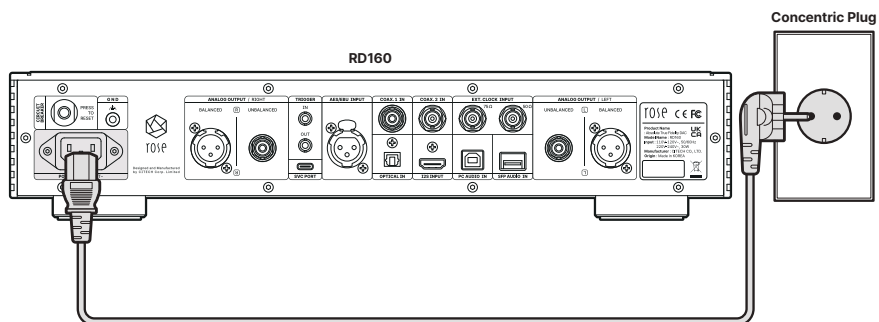

- ⚠ Caution :** When disconnecting the power cord, always disconnect the power outlet first with the power switch off.

# 3. How to Properly Connect Rear Ports and Cables

## 3-1. Connection Between Analog Output Port and Amplifier or AV Receiver

- You can connect the analog (BALANCED/UNBALANCED) audio output of this product to the analog input port of the amplifier or AV receiver as shown in the figure below.

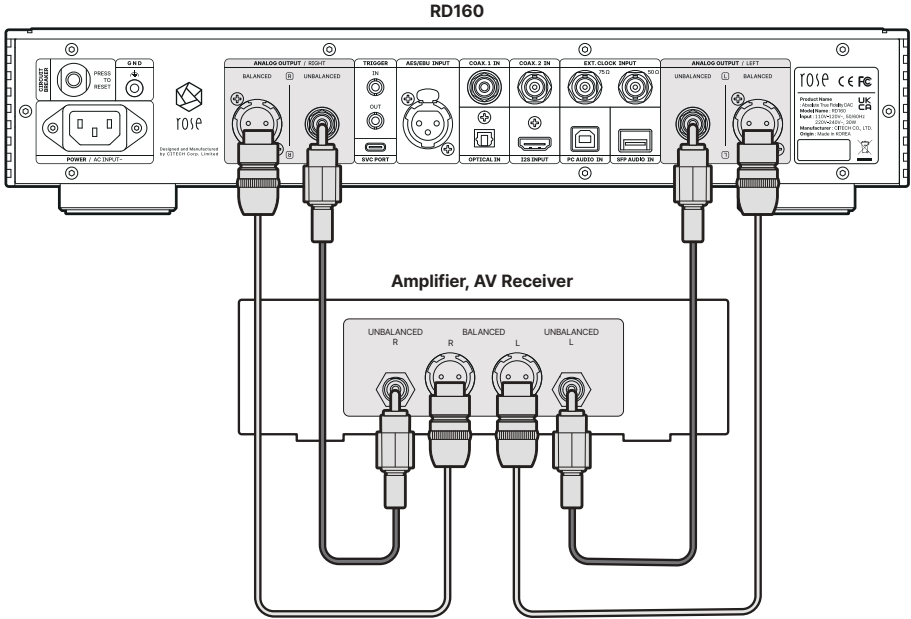

**⚠ Caution:** Before connecting this product to the amplifier, set the volume of the product to mute or below level 5, and then connect it using an interconnector. If you connect the cable while the product is playing music at a high volume, a loud shock sound may occur.

## 3-2. Connection Between Digital Input Port and Audio Device (TV or Devices That Provide Digital Output Capabilities)

### 3-2-1. OPTICAL/COAX.1,2

- You can connect the digital input/output port of an external device to the digital (OPTICAL/COAXIAL) input/output port of this product as shown in the figure below.
- This product can reproduce linear PCM signals with sampling frequencies of 96kHz, 176.4kHz, 192kHz and 384kHz. (However, OPTICAL is supported up to 192kHz)
- You can change the Input Setting from the screen, settings and the remote control.

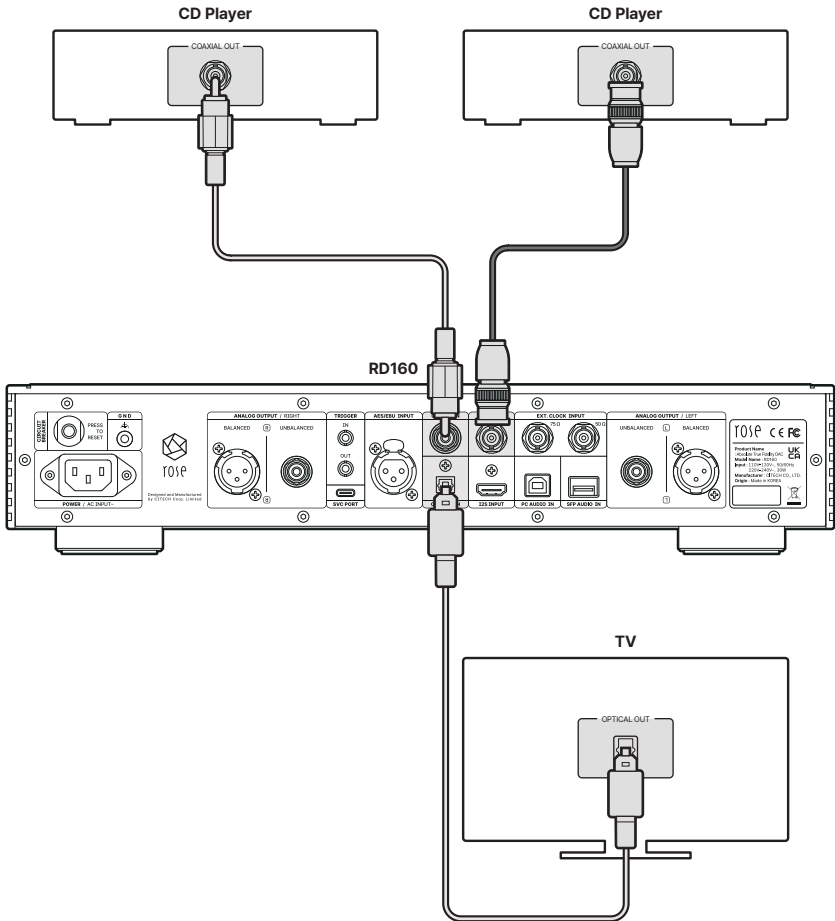

**⚠ Caution:** Do not input signals other than linear PCM signals such as Dolby Digital, DTS, and AAC to this device. It may cause noise and damage to the speakers.

### 3-2-2. AES/EBU

- You can connect the digital output port of an external device to the AES/EBU input port of this product as shown in the figure below.

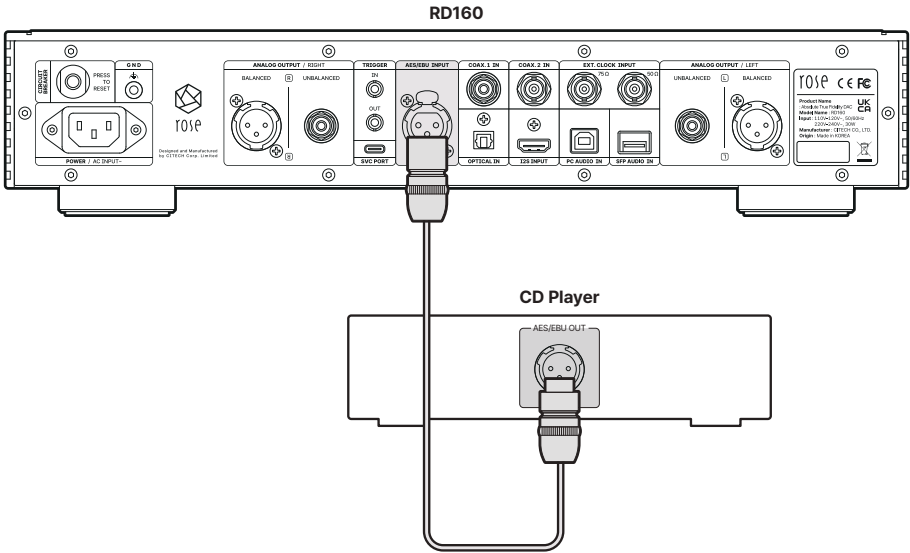

### 3-2-3. I2S IN

- You can connect the digital output port of an external device to the I2S input port of this product as shown in the figure below.

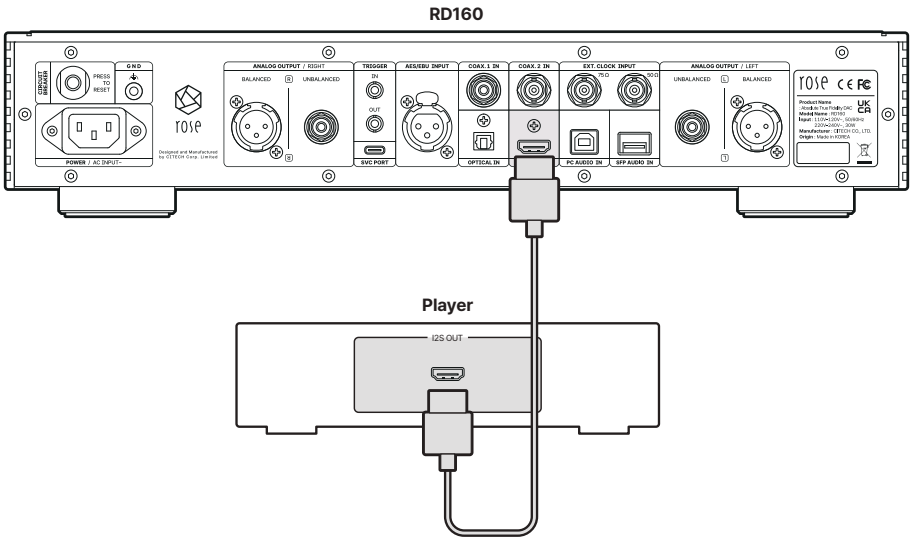

### 3-3. PC AUDIO Connection

- Connect the device as shown in the figure below.

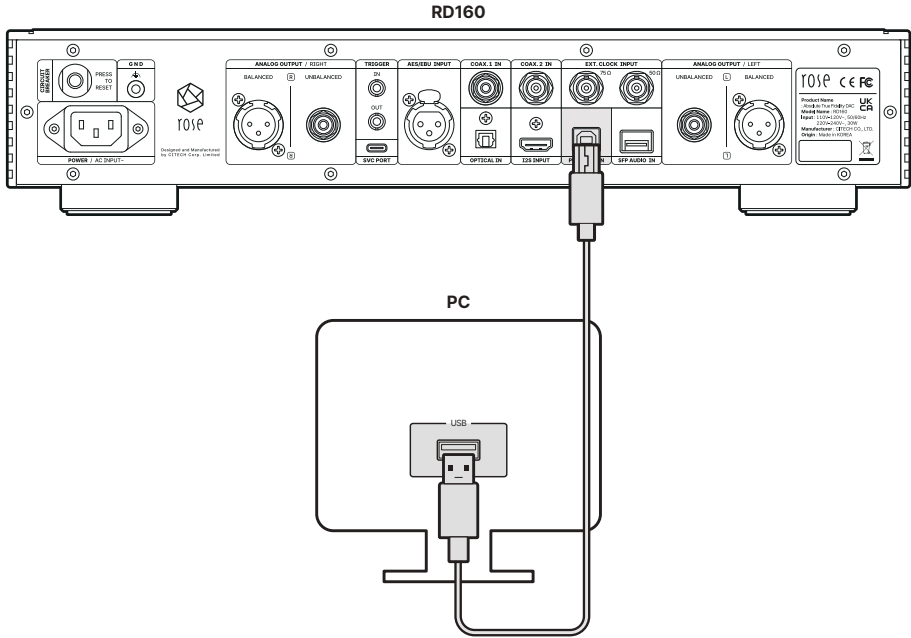

- **3-3-1.** After accessing the ROSE website, download the Rose\_UsbAudio\_[VERSION].zip file in "Downloads" under "Support". You can access this category by entering the URL in the browser (<https://hifirose.com/download>) or by scanning the QR code on the right.



- **3-3-2.** When you unzip the downloaded Rose\_UsbAudio\_[VERSION] file and run Rose\_UsbAudio\_[VERSION].exe, the screen appears as shown in the picture below. Please select Next.

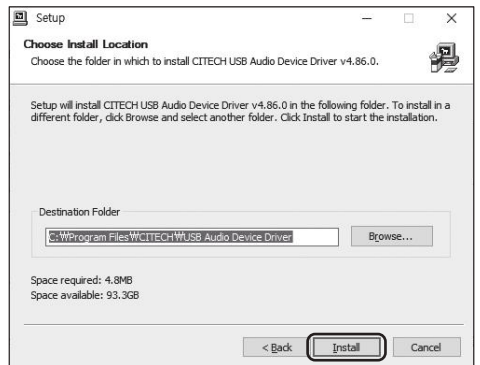
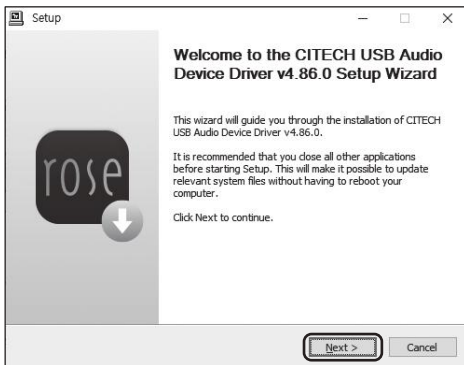

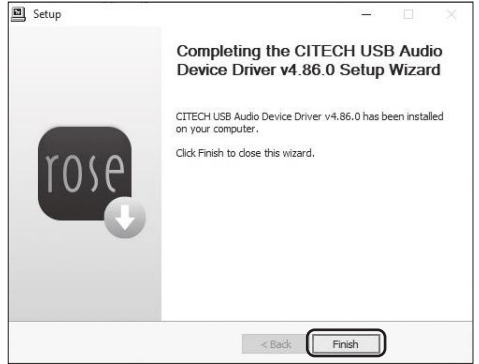
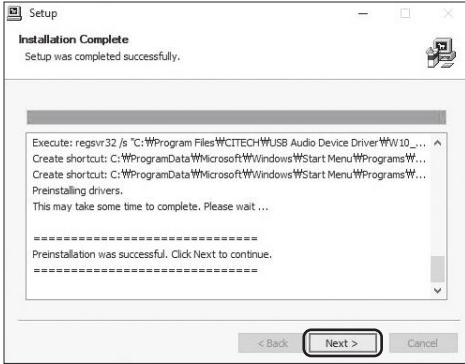

- **3-3-3.** Reboot after installing USB Audio Device Driver.
- **3-3-4.** After driver installation is complete, switch the source to USB IN in the In/Out Setting, and you can check the RD160-DAC on your PC as shown below.

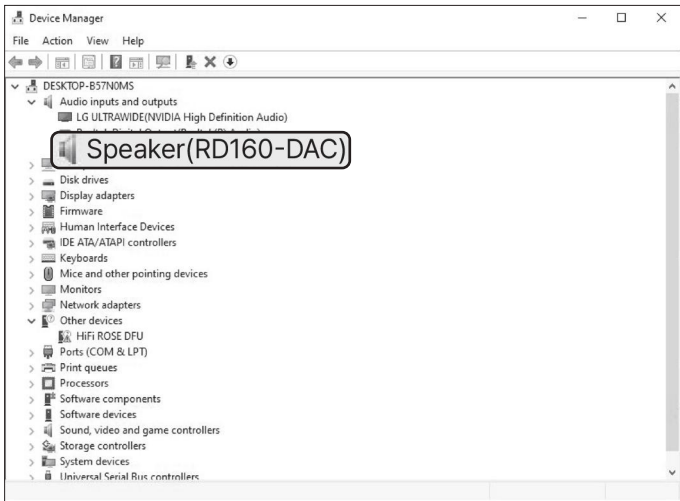

- **3-3-5.** When you set the sound device to RD160-DAC in the system tray area of your PC, you are ready to use the device connected to the USB IN port.

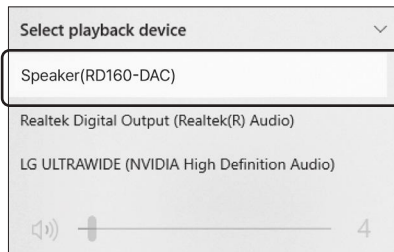

### 3-4. SFP AUDIO Connection

- You can connect an external digital output device to the SFP AUDIO IN port of this product using an SFP module and optical cable as shown in the figure below.

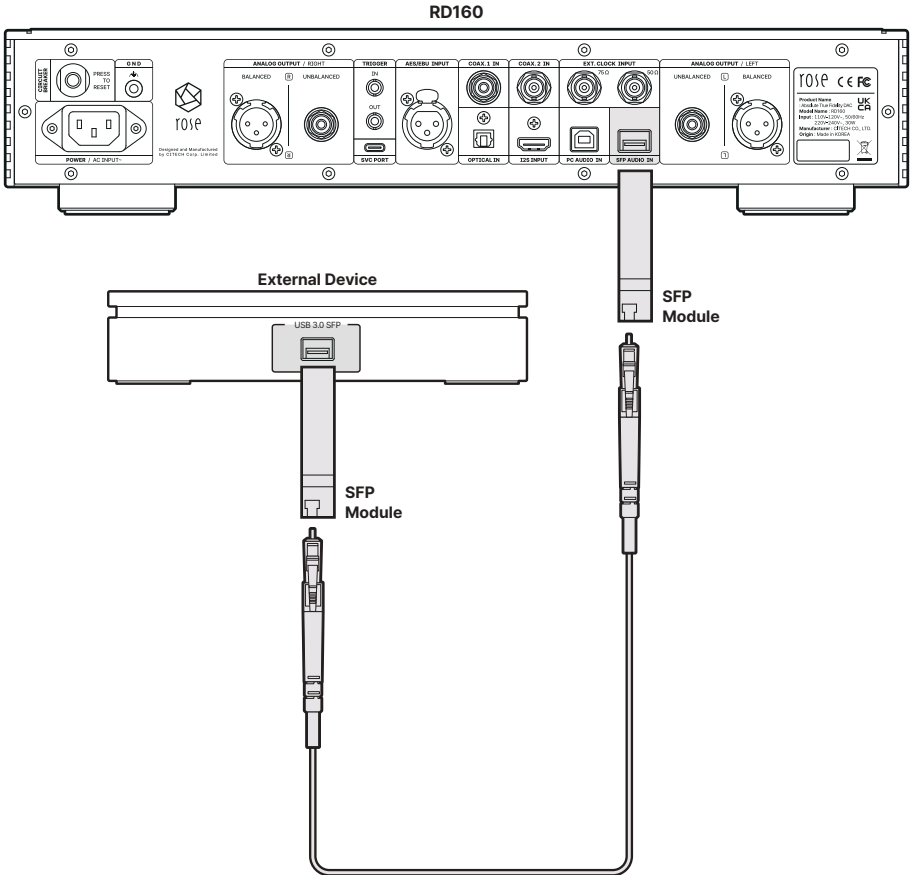

### 3-5. TRIGGER Input Terminal and Pin out

- The trigger function can control the power by linking the product and the source device.
- If you are using a source device with a trigger output terminal, you can use it as a trigger function to control the power on and off by connecting it to the trigger input terminal of the product with a monaural mini-plug cable.

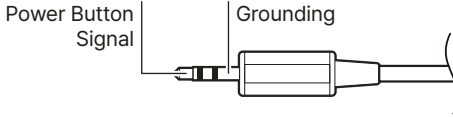

**Trigger Input Voltage : DC 3.3V ~ DC 12V**

**Trigger Output Voltage : DC 12V**

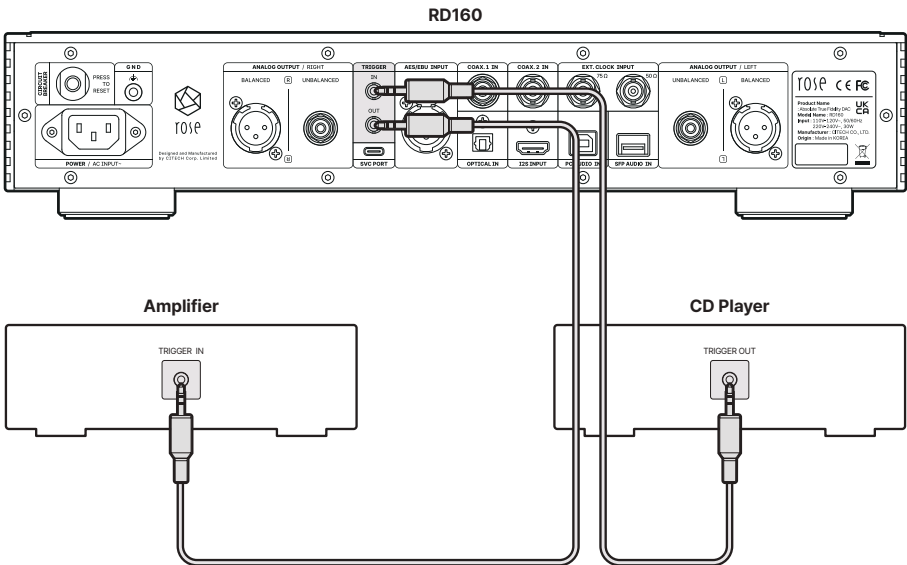

### 3-6. EXT. CLOCK Connection

- You can use an external clock by connecting it to the EXT. CLOCK port of this product as shown in the figure below.
  - To use the master clock using an external device, you can select "External 50Ω" or "External 75Ω".
- ※ Please make sure that the external device has an output impedance value of 50Ω or 75Ω and connect it to the appropriate port.

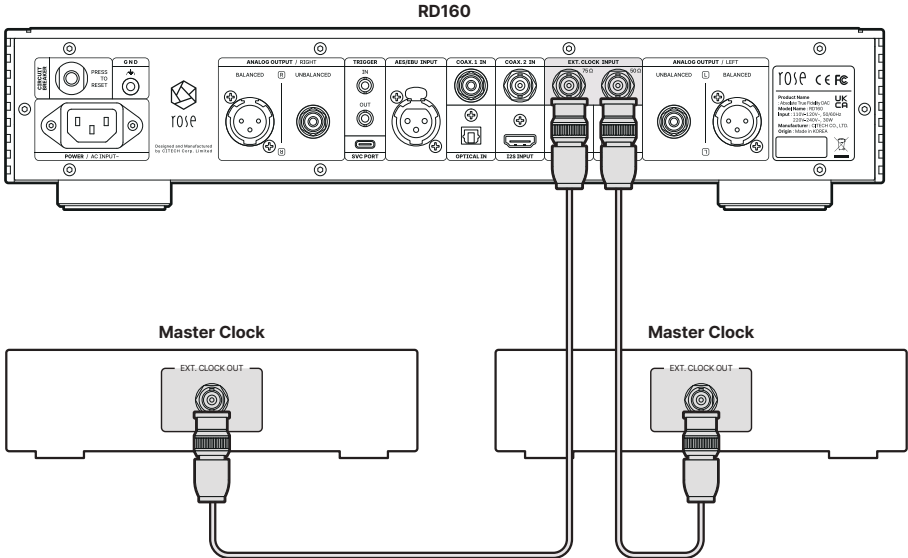

## 3-7. Circuit Breaker

- This is a circuit breaker terminal to protect the circuit from damage caused by overvoltage or overcurrent.
  - Similar to the power circuit breaker in a home, when overvoltage or overcurrent is applied from the outside, the switch terminal protrudes outward to block the power supply. When pressed again by hand, the terminal is inserted inward, connecting the internal circuit to the power supply.
- ※ If the protruding motion is repeated even after you press the switch, there may be a problem with the internal circuit. Please remove the power cord and request product repair.

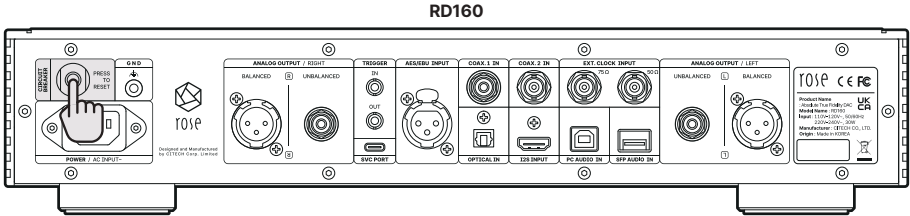

### 3-8. GND Connection

- You can ground the GND terminal of an external device to the GND terminal of this product as shown in the figure below.
- ※ When a lot of noise is generated, you can reduce the noise by connecting this GND terminal to the signal GND of an external device.
- ※ Reversing the signal GND connection may increase noise and cause unintended errors. In this case, please remove the signal GND connection line between the devices.

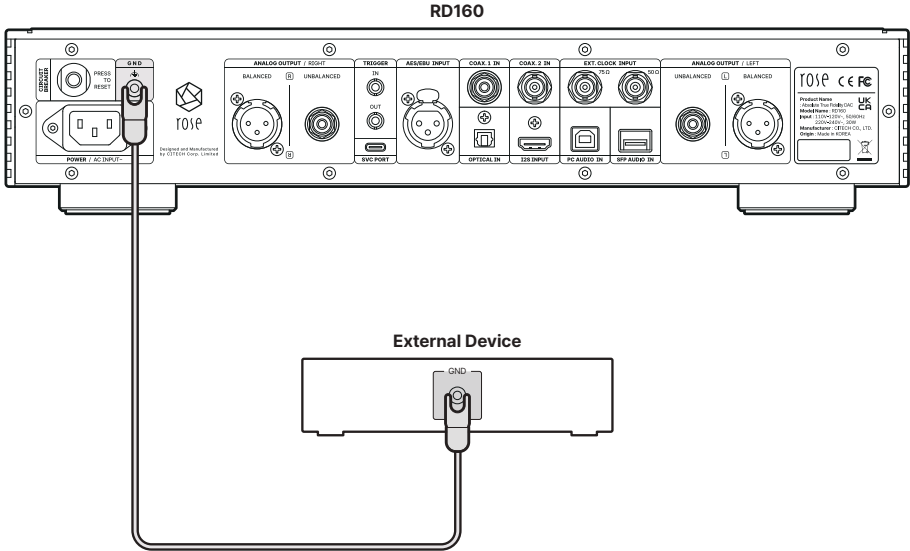



rose

# Product Specifications

## Benchmark

<b>Input Sensitivity</b>	0dB 1kHz
<b>Output Impedance</b>	300Ω
<b>Output Level</b>	4.5Vrms(RCA), 9Vrms(XLR)
<b>THD + N</b>	0.005%(RCA), 0.005%(XLR) (1kHz 0dB)
<b>Signal to Noise Ratio</b>	124dB(RCA), 124dB(XLR)
<b>Residual Noise</b>	0.3mV(RCA), 0.4mV(XLR)
<b>Stereo Crosstalk</b>	-124dB(RCA), -124dB(XLR) (1kHz 0dB)
<b>Frequency Response</b>	10Hz ~ 20kHz (-0.3dB) 10Hz ~ 50kHz (-1.5dB) 10Hz ~ 73kHz (-3.0dB)

## Sampling Rate

<b>PCM</b>	8kHz~768kHz(8/16/24/32bit per Sample)
<b>DSD</b>	DSD64(2.8MHz)/DSD128(5.6MHz)/DSD256(11.2MHz)/DSD512(22.6MHz)

## Technical

<b>DAC</b>	2 × AK4499EXEQ + 2 × AK4191EQ (AKM)
<b>PSU</b>	3 × Independently Customized Reference Linear Toroidal
<b>CPU</b>	RK3128 Quad core Cortex-A7mp
<b>RAM</b>	DDR3 1866MHz 1GB
<b>FLASH</b>	8GB eMMC
<b>Oscillator</b>	High Precision OCXO clock

## Inputs

<b>Digital</b>	USB SFP Module	PCM 32bit/768kHz, DSD512(22.6MHz)
	USB 2.0 Type-B	PCM 32bit/768kHz, DSD512(22.6MHz)
	HDMI I2S	PCM 32bit/768kHz, DSD512(22.6MHz)
	Coaxial RCA	PCM 32bit/384kHz, DSD128(5.6MHz) (only DoP)
	Coaxial BNC	PCM 32bit/384kHz, DSD128(5.6MHz) (only DoP)
	Optical	PCM 32bit/192kHz, DSD64(2.8MHz) (only DoP)
	AES/EBU	PCM 32bit/384kHz, DSD128(5.6MHz) (only DoP)
<b>External Clock</b>	BNC 75Ω(10MHz), SMA 50Ω(10MHz)	

## Outputs

<b>Analog</b>	Unbalanced, Balanced
---------------	----------------------

## Feature

---

<b>PCM Filter</b>	Sharp Slow Short Sharp (default) Short Slow Super Slow Low Short
<b>Pre-Out Level</b>	1V~9V

---

## Power

---

<b>Input Voltage</b>	AC110V-120V~, 220V-240V~, 50/60Hz
<b>Standby</b>	0.3W
<b>Playback</b>	30W

---

## Environmental

---

<b>Operating °C</b>	0~40°C
<b>Storage °C</b>	-10~50°C

---

## Physical

---

<b>Display</b>	AMOLED hidden screen
<b>Dimension</b>	430(W) × 330(D) × 88(H) mm
<b>Weight</b>	10kg
<b>Material</b>	Solid Aluminum / Rust-proof Steel
<b>Finish</b>	Silver, Black
<b>IR</b>	38kHz IR Receiver

---

# Quality Guaranteed

<b>Model Name</b>	RD160
<b>Purchase Date</b>	DD / MM / 20YY
<b>Place of Purchase</b>	Shop Name
	Contact Address
<b>Serial No.</b>	
<b>Contact Address</b>	
<b>Warranty Period</b>	Until 1 year from the date of purchase

- Name of the Company that Received the Conformity Assessment: CITECH Co., Ltd.
- Manufacturer/Country of Manufacture: CITECH Co., Ltd. / Republic of Korea
- Identification Code of the Certified Company: SYH
- Certification No.: R-R-SYH-RD160

**Product Website: [www.hifirose.com](http://www.hifirose.com)**

- Get news about the latest events and new product information from ROSE through the news
- You can find an authorized dealer or reseller near you on the website.



## **Things to Check Before Contacting the Service Center**

---

- Please restart the product if the screen freezes. Press the power button to turn the power off, then turn it back on.
- If the switch does not work while the product is in use, it may be because it was exposed to severe static electricity. Please disconnect the power cord before starting again.
- When the product is used for a long time in a confined space that does not meet the product installation conditions (p. 24), it may generate heat and become hot, affecting the life and performance of the product.  
Always keep the ventilation openings on the top of the main body open so that heat dissipation inside is not disturbed.
- If there is no output sound, check the input source selector of the main unit, and check that the speaker connection status, and the volume control level are not "0."
- If the remote control does not work, the battery may be empty. Replace it with a new battery.

## **Repair Service Guide**

---

### **• Free Repair**

Limited to naturally occurring failures within one year from the date of purchase, which is the warranty period of the product.

### **• Paid Repair**

If the warranty period has expired, or even if it is within the warranty period, in the following cases, the actual cost of repair (including part costs) will be charged.

- Failure due to consumer negligence during use
- Repairs or modifications made by persons other than company engineers
- Failure or damage caused by an abnormality in the power supply
- Failure due to a natural disaster

### **• Repair Service Application Guide**

If a failure occurs during use, stop using it immediately and consult with the place of purchase or the customer support office of the company first.

### **• Information required for reporting**

- Model name and serial number (manufacture date)
- Place and date of purchase
- Consumer information including contact information and address
- Symptoms of failure
- All other matters necessary for repair service

### **• Precautions for Product Delivery to the Service Center**

Be sure to pack the product in the original box and inner protective material to prevent damage when delivering the product by courier. Please note that we are not responsible for damage to the product during transportation of the product in other packaging.

## UK PSTI Statement of Conformity

We, Citech, Co., Ltd. hereby declares that this product complies with the applicable security requirements set out in Schedule 1 of The Product Security and Telecommunications Infrastructure (Security Requirements for Relevant Connectable Products) Regulations 2023 at the time of this Statement, required by the UK government in the Product Security & Telecommunications Infrastructure Act 2022.

Citech, Co., Ltd. will provide software security updates for this product as described on this webpage:

<https://hifirose.com/Legal/>



If you detect a vulnerability with this product, please contact us following the guidance covered on this webpage:

<https://hifirose.com/QnA?category=34zK754S49/>



\* This statement was last updated on 04.04.2024.



**HIFI ROSE / CITECH**











