

APP



Google Play and the Google Play logo are trademarks of Google Inc.



Apple and the Apple logo are trademarks of Apple Inc.



Download the soundcore app to experience adaptive noise cancelling, ambient sound modes, Dolby Audio, HearID sound, firmware update, and more exciting features.

If your headphones cannot connect with the soundcore app, re-install the app or update it to the latest version in your mobile app store.

OVERVIEW

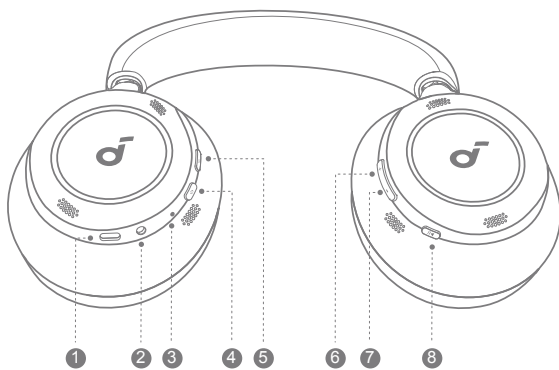

1. USB-C Charging Port
2. 3.5mm Input
3. LED Indicator
4. Power Button
5. NC Button
6. Volume Up Button
7. Volume Down Button
8. Multi-function Button

FOLDING YOUR HEADPHONES

1. Turn both panels around until you can see the "L" and "R" marks.



2. Fold up the left panel, then rotate the right panel to the position where you can see the soundcore logo.

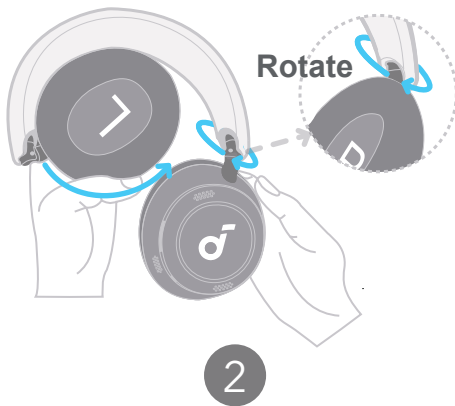

3. Fold up the right panel to align with the left panel.

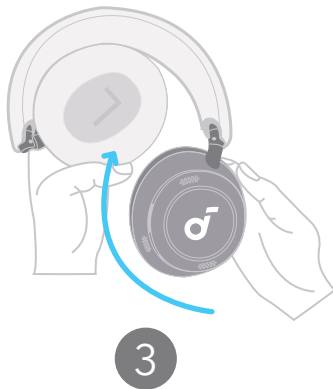

4. Now you've successfully folded your headphones.



WEARING



Wear the headphones with the "L" logo on your left ear and "R" logo on your right ear. Adjust the length of the headband for a comfortable fit.

POWERING ON AND PAIRING

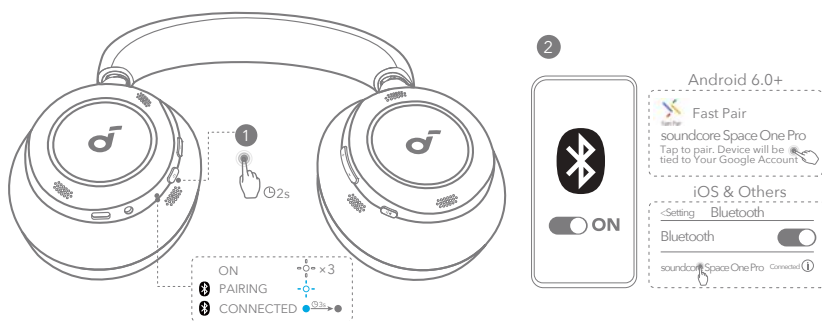

Auto Pairing: Press and hold the power button for 2 seconds to power on. The headphones will automatically enter Bluetooth pairing mode when connecting for the first time. Select **"soundcore Space One Pro"** on your device's Bluetooth list to connect.

- When pairing, the LwED indicator will start flashing blue slowly. After the pairing is successful, the LED indicator will stay on for 3 seconds and then go off.

Google Fast Pairing: Enjoy instant pairing with your Android smartphone (running Android 6.0 and above) via Fast Pair enabled by Google.

To manually enter Bluetooth pairing mode, when the headphones are powered off, press and hold the power button for 5 seconds to pair.

CHARGING

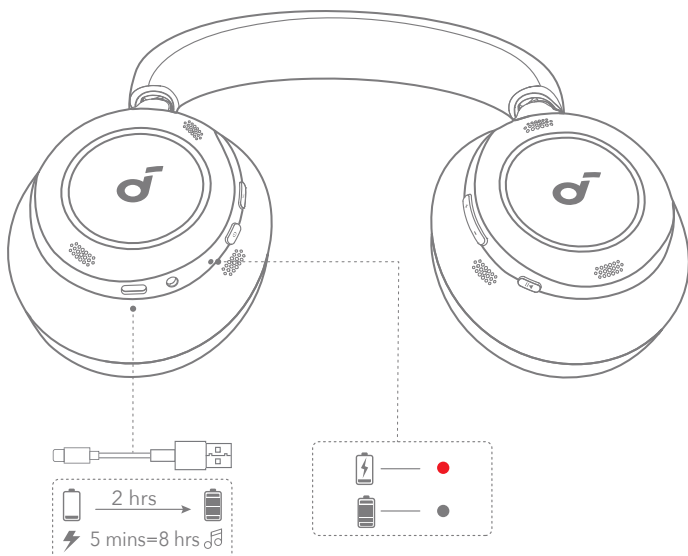

When the battery is running low, you will hear a voice prompt.

Use the provided USB-C charging cable to connect your headphones to a power source.

A full battery recharge takes about 2 hours, and 5 minutes of charging offers 8 hours of wireless playtime.

- Fully dry the USB port before charging.
- Do not turn on your headphones while charging.

DUAL CONNECTIONS

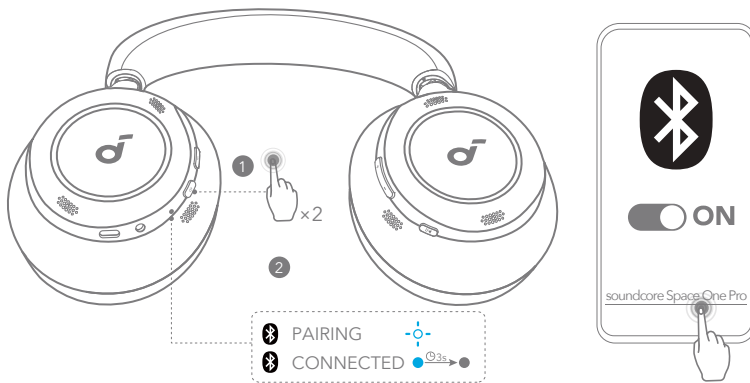

The headphones can connect with two devices at the same time.

When already connected to one device, press the power button twice to pair with another device.

You can also enable Dual Connections via the soundcore app.

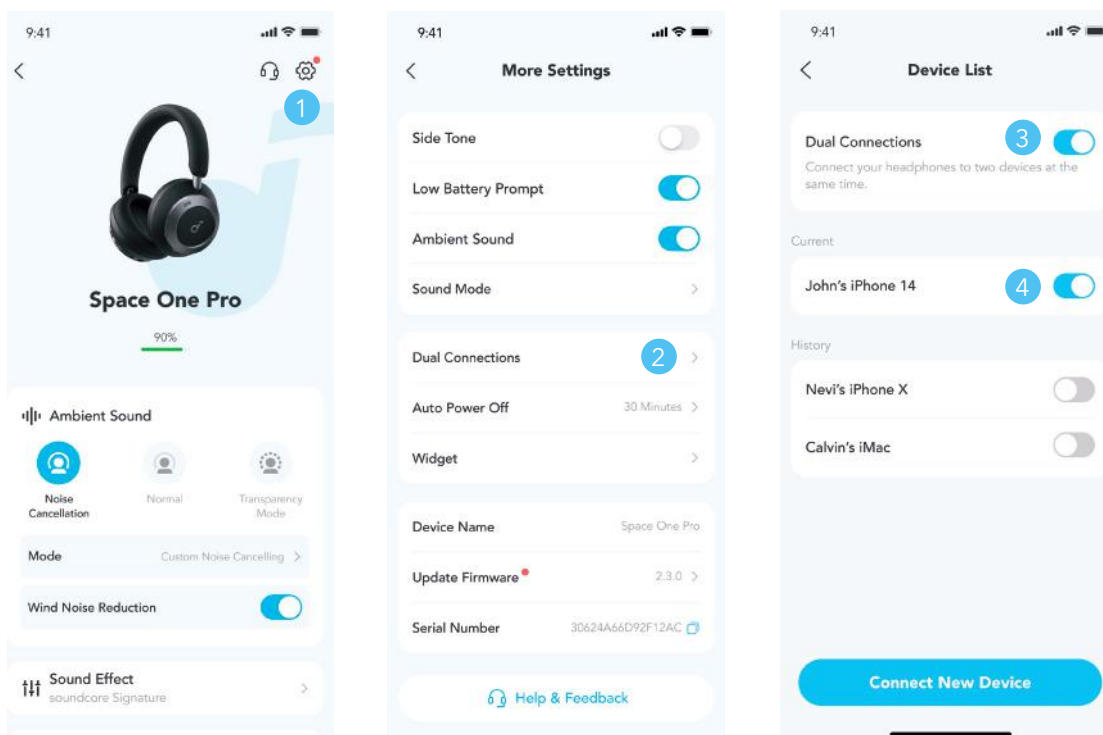

In the soundcore app, go to settings and select **Dual Connections > Enable Dual Connections > Connect New Device**.

*You can clear the history of previously-connected devices in **Device List**.

BUTTON CONTROLS

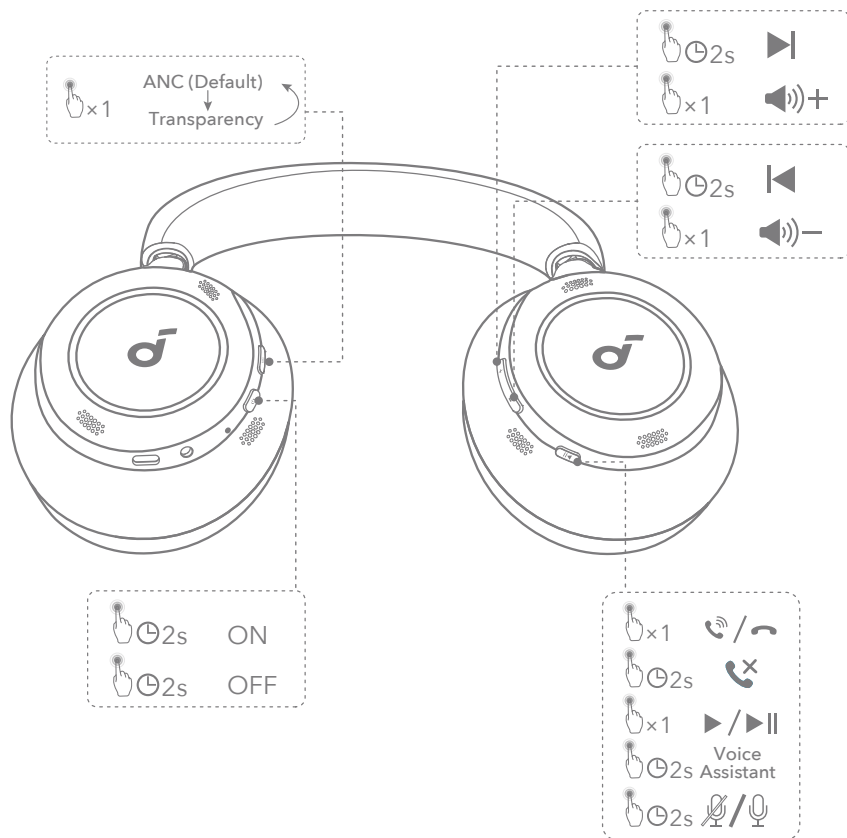













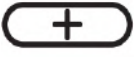

x1: Press once

x2: Press twice

2s: Press and hold for 2 seconds

* You can enable Normal mode in the soundcore app.

	Switch ambient sound modes (ANC / Transparency)		Press once
	Power on / off		Press and hold for 2 seconds
	Play / Pause		Press once
	Next track		Press and hold for 2 seconds
	Previous track		Press and hold for 2 seconds
	Volume up		Press once
	Volume down		Press once
	Answer / End a call		Press once
	Reject a call		Press and hold for 2 seconds
	Mute / Restore the microphone		Press and hold for 2 seconds
	Activate Voice Assistant		Press and hold for 2 seconds

NOISE CANCELLATION

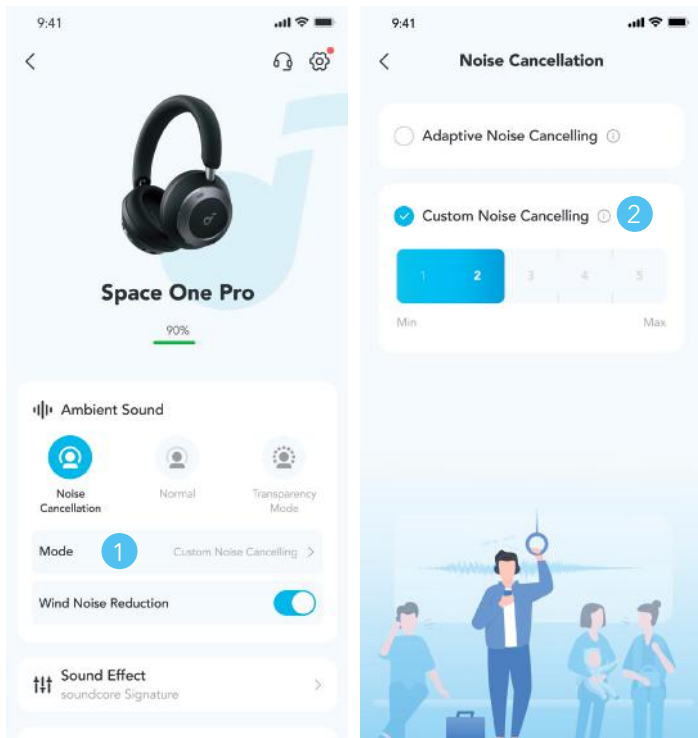

To reduce ambient noise, switch to noise cancellation (default) via the NC button and customize it in the soundcore app.

- Adaptive Noise Cancelling: Perform real-time calculation based on the external environment and wearing condition to ensure optimal noise cancellation.
- Custom Noise Cancelling: Set the level of noise cancellation manually.

TRANSPARENCY

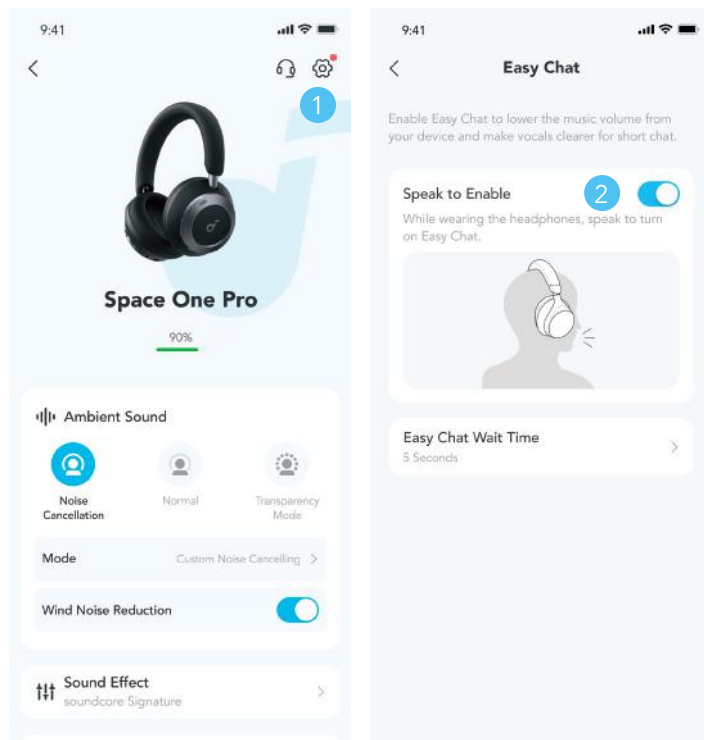

To stay aware of your surroundings while listening to music, switch to transparency mode via the NC button and customize it in the soundcore app.

- Custom Transparency Mode: Set the level of transparency manually.

SIDETONE

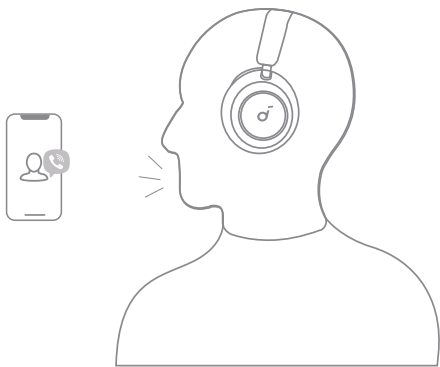

With the Sidetone feature on, you will hear your own voice loud and clear when making or receiving phone calls using the headphones.

*Sidetone feature is on by default. You can disable this feature via the soundcore app.

EASY CHAT

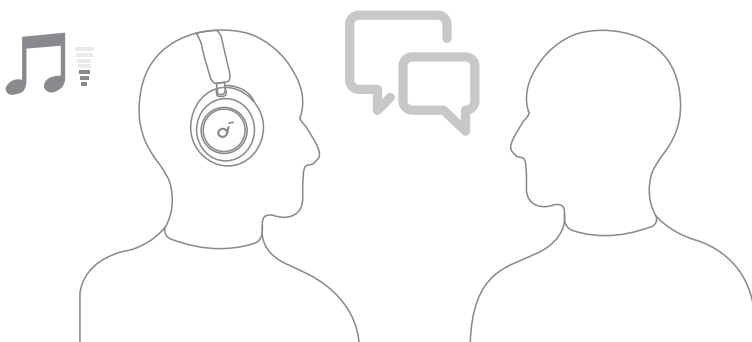
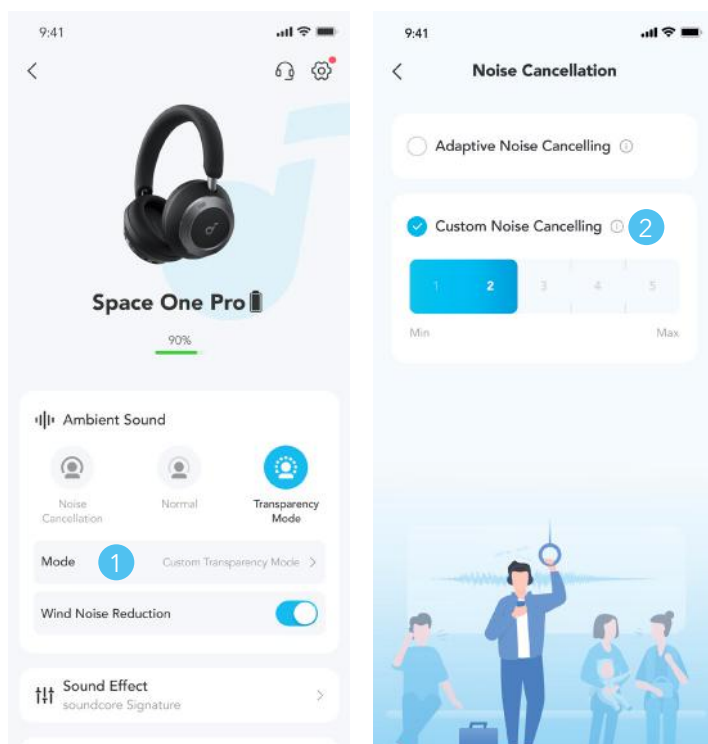

Easy Chat mode automatically lowers the volume of music and amplifies the voice of the person you're talking to so that you can communicate without taking the headphones off. When you have stopped talking for 5 seconds (the duration can be set in soundcore app), your headphones will automatically exit Easy Chat mode and resume normal volume.

*You need to enable Easy Chat mode via the soundcore app.

LDAC

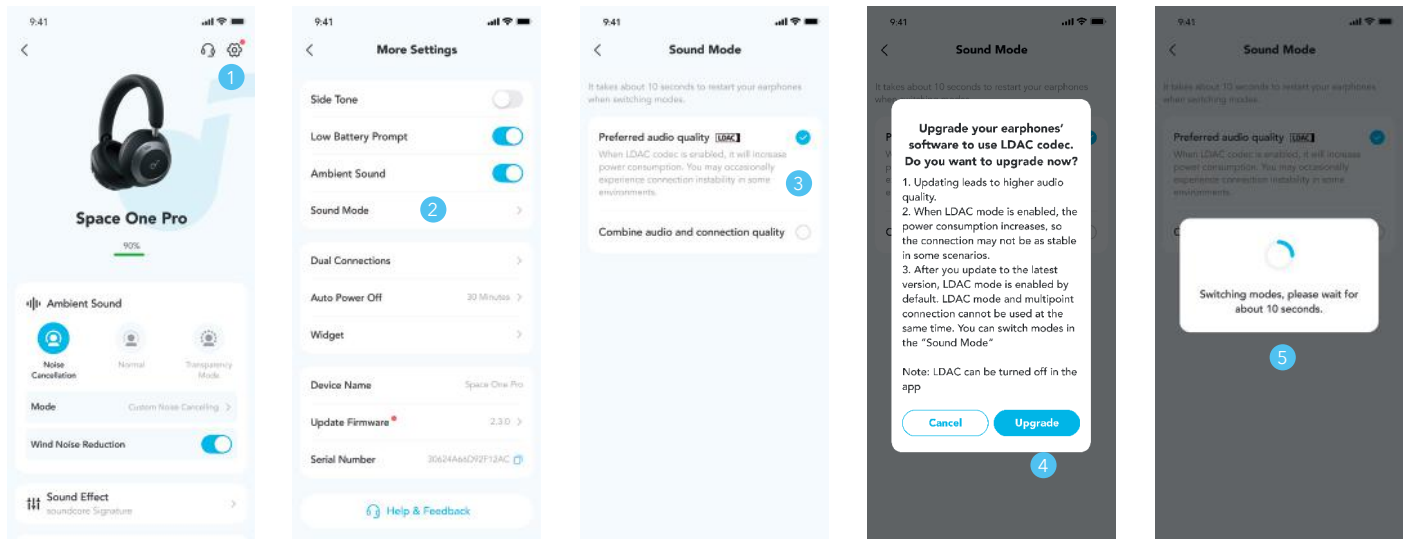

Enable LDAC in the soundcore app for higher-quality audio.

*Only available on devices powered by Android 8.0 or later.

- Use devices powered by Android 8.0 or later to experience LDAC quality sound.
- LDAC provides higher quality sound, increases power consumption, and reduces playtime.
- Enable LDAC in a low-interference environment to ensure a stable Bluetooth connection.

1. Go to settings in the soundcore app.
2. Click on "Sound Mode".
3. Select "Preferred audio quality" to switch to LDAC codec.
4. You will be notified that the headphones do not support LDAC when connected to two devices. Also, please note that Dolby Audio is not supported when LDAC has been enabled. Select "Turn on" to continue.
5. It takes about 10 seconds to switch audio codecs. You may be requested to update the headphones' firmware if available.

WIRED LISTENING

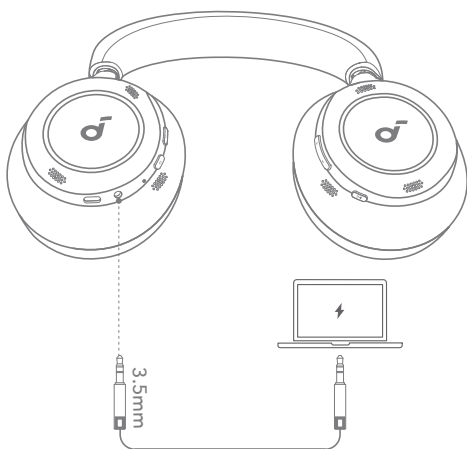

Play audio on an external device by plugging in a 3.5mm AUX cable. Wired listening will automatically turn off Bluetooth mode.

*During wired listening, you can only switch ambient sound modes (ANC / Transparency) via the NC button. And other buttons will not function.

RESET

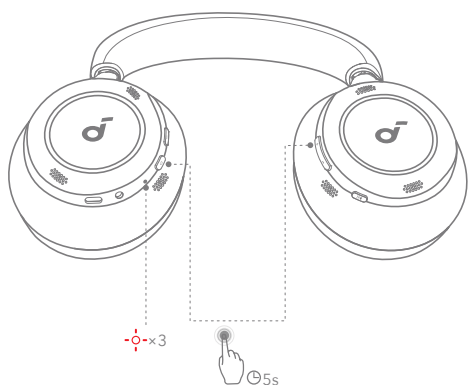





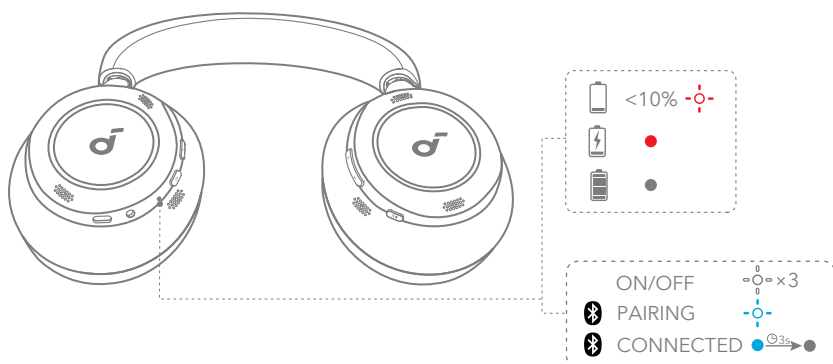

You might need to reset your headphones if you experience connectivity or function issues.

Delete the pairing history from your Bluetooth device first. Press and hold the volume up and power button simultaneously for 5 seconds until the LED flashes red three times.

LED LIGHT GUIDE



	Flashing white
	Flashing red slowly
	Flashing blue slowly
	Steady blue
	Steady red
	Light off

FIRMWARE UPDATE

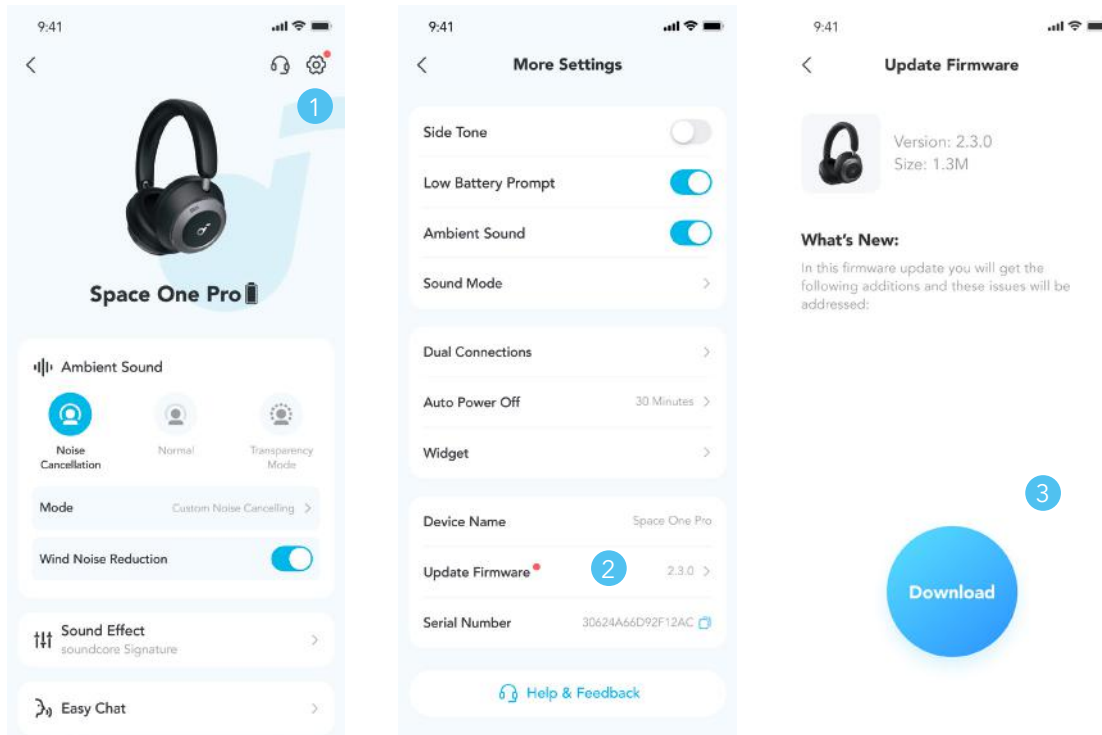

You will be informed once the new version of firmware is detected when you connect the headphones with the app. Ensure the headphones are powered on and connected to a device until the firmware update is complete. During the update, avoid any usage and ensure stable access to the internet.

SPECS

Specifications are subject to change without notice.

Input	5V/1.2A
Battery capacity	350mAh*2
Charging time	2 hours
Playtime (with ANC off)	60H
Playtime (with ANC on)	40H
Driver size	40mm
Frequency response	20Hz-40kHz
Impedance	16Ω
Bluetooth version	5.3
Bluetooth range	15m

Regulations and Compliance Information

Hereby, Anker Innovations Limited declares that this device is in compliance with The Product Security and Telecommunications Infrastructure (Security Requirements for Relevant Connectable Products) Regulations 2023. For the Statement of Compliance, visit the website: <https://uk.soundcore.com/pages/psti-related>.

Note: The 'x' of SN Code: xxxxxxxxxxxxxxxx is a variable, see below table.

Variable 'x'	Range of variable	Content
Seventh	0-9 or A-F	Denotes the hardware version which is not effected on the safety compliance.
Eighth	8,9,A,B,C...	Denotes the year, 8 means 2018, 9 means 2019, A means 2020, B means 2021, C means 2022, and so on.
Ninth and tenth	01,02,03..	Denotes weeks, 01 means the first week in this year, 02 means the secondary week in this year, and so on.
Eleventh	1-7	Denotes date, 1 means Monday, 2 means Tuesday..., 7 means Sunday and so on.
The last five	00001-99999	Denotes serial No.