

Operating and installation instructions Ventilation hood

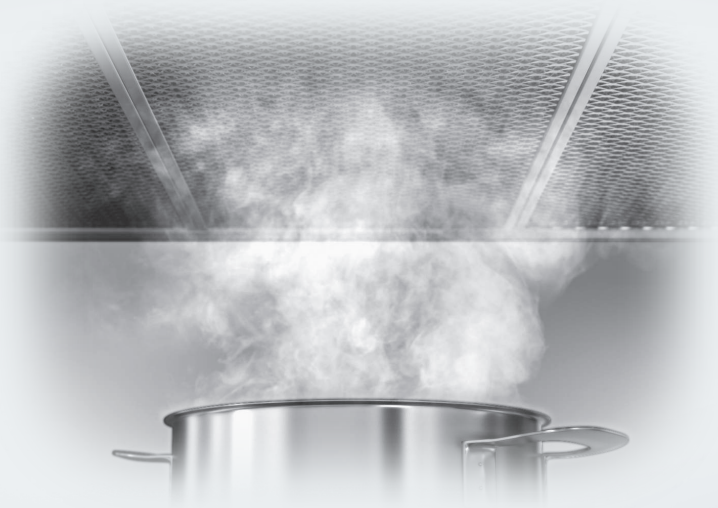

To prevent accidents and damage to the appliance, you **must** read these instructions before installing the appliance and using it for the first time.

Contents

IMPORTANT SAFETY INSTRUCTIONS	4
Sustainability and environmental protection	12
Familiarization	13
Guide to the ventilation hood.....	13
Components.....	14
Grease filters and panel.....	14
Charcoal filter.....	14
Overhead lighting.....	14
Functions.....	15
Blower power levels.....	15
Delayed shutdown function.....	15
Operating hours counter.....	15
Miele@home.....	16
Con@ctivity.....	16
Power management.....	16
Commissioning	17
Selecting extraction mode or recirculation mode.....	17
Setting up Miele@home.....	18
Performing Scan & Connect.....	18
Signing off Wi-Fi and remote control.....	19
Setting up Con@ctivity.....	19
Activating Con@ctivity 3.0 via the home Wi-Fi network.....	19
Activating Con@ctivity 3.0 via a direct Wi-Fi connection.....	19
Reattempting the connection.....	20
Preparing the remote control.....	20
Signing on the remote control.....	20
Signing off the remote control.....	20
Operation (automatic)	21
Cooking with Con@ctivity over an electric cooktop.....	21
Cooking with Con@ctivity over a gas cooktop.....	21
Temporarily exiting Automatic mode.....	22
Operation (manual)	23
Cooking without Con@ctivity (Manual mode).....	23
Turning on the blower.....	23
Selecting the power level.....	23
Selecting the delayed shutdown time.....	23
Turning off the blower.....	23
Delayed shutdown in Plug&Play operation.....	23
Turning the overhead lighting on/off.....	23

Customizing settings	24
Intervals for the grease filter operating hours counter.....	24
Changing the intervals for the grease filter operating hours counter.....	24
Intervals for the charcoal filter operating hours counter	24
Altering or deactivating the charcoal filter operating hours counter intervals.	24
Safety shut-off.....	25
Energy-saving tips	26
Cleaning and care	27
Cleaning the casing.....	27
Grease filters and edge extraction panel	27
Condensation on the panel	28
Inserting the panel.....	30
Resetting the grease filter operating hours counter	30
Replacing the grease filters	30
OdorFree Charcoal Filter.....	30
Resetting the charcoal filter operating hours counter.....	31
Disposing of charcoal filters.....	31
Remote control	31
Inserting/replacing batteries	31
Cleaning the remote control	31
Customer Service	32
Contact in the event of a fault	32
Location of the data plate	32
Appliance warranty and product registration	32
Installation	33
Before installation	33
Removing the protective film.....	33
Coating the panel	33
Installation materials.....	33
Appliance dimensions.....	34
Distance between cooktop and ventilation hood (S).....	37
Installation notes	38
Plug&Play mode	38
Air venting.....	39
Non-return flap.....	39
Condensate	40
Reducing Collar	40
Electrical connection	41
Technical data	42
Optional accessories for recirculation mode.....	42

IMPORTANT SAFETY INSTRUCTIONS

READ AND SAVE THESE INSTRUCTIONS

This appliance complies with current safety requirements. Improper use of the appliance can lead to personal injury and material damage.

Read all instructions before installing or using the appliance for the first time. Only use the appliance for its intended purpose.

Keep these operating instructions in a safe place and pass them on to any future user.

Appropriate use

- ▶ **CAUTION:** For General Ventilating Use Only. Do Not Use To Exhaust Hazardous Or Explosive Materials And Vapors.
- ▶ This appliance is intended for residential use only. Use only as described in these operating instructions.
- ▶ This ventilation hood is not intended for outdoor use.
- ▶ It must only be used to extract and clean vapors produced during cooking. Any other use occurs at the owner's own risk.
- ▶ Where a recirculation ventilation hood is installed above a gas cooktop, please check that all local codes are observed to insure an adequate supply of fresh air.
- ▶ This appliance is suitable for installation above gas or electric cooking surfaces. Please refer to cooktop instructions.
- ▶ Persons who lack physical, sensory or mental abilities, or experience with the appliance should not use it without supervision or instruction by a responsible person.

Safety with children

- ▶ Children must be kept away from the ventilation hood unless they are constantly supervised.
- ▶ Children must not be allowed to clean or service the hood.
- ▶ Please supervise children in the vicinity of the hood and do not let them play with it.
- ▶ The LED ClearView lighting is very intense. Avoid looking directly into the light for prolonged periods of time.

IMPORTANT SAFETY INSTRUCTIONS

- ▶ Danger of suffocation. While playing, children may become entangled in packaging material (such as plastic wrapping) or pull it over their head, presenting the risk of suffocation. Keep packaging material away from children.
- ▶ Keep the battery for the remote control out of the reach of children.

Technical safety

- ▶ **WARNING: TO REDUCE THE RISK OF FIRE, ELECTRIC SHOCK, OR INJURY TO PERSONS, OBSERVE THE FOLLOWING:**
 - Use this appliance only in the manner intended by the manufacturer. If you have questions, contact Miele.
 - Before servicing or cleaning the appliance, switch power off at the service panel and lock the service disconnecting means to prevent power from being switched on accidentally. If the service disconnecting means cannot be locked, securely fasten a prominent warning device, such as a tag, to the service panel.
 - Do not use replacement parts that have not been recommended by the manufacturer (e.g. parts made at home using a 3D printer).
- ▶ Unauthorized installation, maintenance, and repairs can cause considerable danger for the user. Installation, maintenance, and repairs should only be carried out by a Miele authorized technician.
- ▶ A damaged ventilation hood can be dangerous. Always check for visible signs of damage. Never use a damaged ventilation hood.
- ▶ Be certain your appliance is properly installed and grounded by a qualified technician. To guarantee the electrical safety of this appliance, continuity must exist between the appliance and an effective grounding system. It is imperative that this basic safety requirement be met. If there is any doubt, have the electrical system of the house checked by a qualified electrician.
- ▶ Do not use a power bar or extension cord to connect the ventilation hood to electricity. These are a fire hazard and do not guarantee the required level of appliance safety.

IMPORTANT SAFETY INSTRUCTIONS

▶ Temporary or permanent operation on an autonomous power supply system or a power supply system that is not synchronized with the grid power supply (e.g., island networks, back-up systems) is possible. A prerequisite for operation is that the power supply system complies with national and local codes.

The function and operation of the protective measures provided in the domestic electrical installation and in this Miele product must also be maintained in isolated operation or in operation that is not synchronized with the grid power supply, or these measures must be replaced by equivalent measures in the installation.

▶ To avoid damaging the ventilation hood, make sure that the connection data (voltage and frequency) on the data plate correspond to the building's power supply before connecting the appliance. If in doubt, consult a qualified electrician.

▶ To ensure safe operation, only use the ventilation hood after it has been properly installed.

▶ This ventilation hood may not be used in non-stationary locations (e.g. on a ship).

▶ Adequate ventilation must be provided when the hood is operated simultaneously with devices that burn gas or other fuels.

▶ Only open the housing as described in the enclosed "Installation diagram" and in the "Cleaning and care" section of this manual. Under no circumstances should any other parts of the housing be opened. Tampering with electrical connections or components and mechanical parts is highly dangerous to the user and can cause operation faults.

▶ During installation, maintenance, and repair work, the ventilation hood must be disconnected from the electrical supply. It is only completely isolated from the electricity supply if one of the following applies:

- The circuit breakers on the electrical service panel are tripped.
- The screw-type fuses on the electrical service panel have been removed.
- The power cord (if present) has been unplugged from the socket (pull the plug not the cord).

▶ While the ventilation hood is under warranty, repairs should be undertaken by a service technician authorized by Miele Service. Otherwise the warranty may be invalidated.

IMPORTANT SAFETY INSTRUCTIONS

- ▶ If the power cord is damaged, it must only be replaced by a qualified service technician.
- ▶ The bulbs are a built-in component of the lighting. Replacement bulbs should only be installed by a Miele authorized technician or by Miele Service.
- ▶ Important information on handling the remote control battery:
 - Do not short circuit or recharge the battery, or throw it into a fire. Danger of explosion!
 - Do not throw old batteries away with your general household waste. Please dispose of them in a designated battery collection and recycling system.

Correct use

- ▶ **WARNING: TO REDUCE THE RISK OF A COOKTOP GREASE FIRE:**
 - a) Never leave surface units unattended. Boilovers cause smoking and greasy spillovers may ignite. Heat oils slowly on low or medium settings.
 - b) Always turn the hood on when cooking at a high heat.
 - c) Clean the ventilation hood frequently. Grease should not be allowed to accumulate on the fan or filter.
 - d) Use the proper pan size. Always use cookware appropriate for the size of the cooking area.

- ▶ Open flames are a fire hazard.

The use of an open flame under the ventilation hood is not permitted. To avoid the danger of fire, do not flambé or grill over an open flame. When switched on, the ventilation hood could draw flames into the filter. Fat deposits could ignite, presenting a fire hazard.

- ▶ Overheated oil and fat can ignite, causing fire damage to the ventilation hood.

Do not leave cookware, pans, and deep-fat fryers unattended when cooking with oil or fat. Similarly, never leave an open flame unattended when grilling.

IMPORTANT SAFETY INSTRUCTIONS

▶ **WARNING: TO REDUCE THE RISK OF INJURY TO PERSONS IN THE EVENT OF A COOKTOP GREASE FIRE, OBSERVE THE FOLLOWING*:**

- a) **SMOTHER FLAMES** with a close fitting lid, cookie sheet, or metal tray then turn off the burner. **BE CAREFUL TO PREVENT BURNS.** If the flames do not go out immediately, **EVACUATE AND CALL THE FIRE DEPARTMENT.**
- b) **NEVER PICK UP A FLAMING PAN** - You may be burned.
- c) **DO NOT USE WATER**, including wet dishcloths or towels - a violent steam explosion will result.
- d) Use a fire extinguisher **ONLY** if:
 - 1) You have a class ABC extinguisher, and you know how to operate it.
 - 2) The fire is small and contained in the area where it started.
 - 3) The fire department is being called.
 - 4) You can fight the fire with your back to an exit.

*Based on “Kitchen Fire Safety Tips” published by NFPA.

▶ The ventilation hood may become damaged if exposed to excessive heat from a gas cooktop.

- When using the ventilation hood over a gas cooktop, ensure that any burners in use are always covered by cookware. Turn burners off when removing the cookware, even if doing so for just a short time.
- Select cookware that is suitable for the size of the burner.
- Adjust the flame so that it never extends up the sides of the cookware.
- Avoid overheating the cookware (e.g., when cooking with a wok).

▶ Always turn the ventilation hood on whenever a burner is in use to prevent damage from condensation.

▶ Fat and debris deposits impair the proper functioning of the ventilation hood.

To ensure that cooking vapors are properly cleaned, never use the ventilation hood without the grease filters in place.

▶ Please note that the heat rising from the stovetop during cooking can cause the ventilation hood to become very hot.

Do not touch the housing or the grease filters until the ventilation hood has cooled down.

IMPORTANT SAFETY INSTRUCTIONS

Proper installation

▶ **WARNING: TO REDUCE THE RISK OF FIRE, ELECTRIC SHOCK, OR INJURY TO PERSONS, OBSERVE THE FOLLOWING:**

- a) Installation work and electrical wiring must be done by qualified person(s) in accordance with all applicable codes and standards, including fire-rated construction.
- b) Sufficient air is needed for combustion and exhausting of gases through the flue (chimney of fuel burning equipment to prevent back drafting. Follow the heating equipment manufacturer's guideline and safety standards such as those published by the National Fire Protection Association (NFPA) and the American Society for Heating, Refrigeration and Air Conditioning Engineers (ASHRAE), and the local code authorities.
- c) When cutting or drilling into the wall or ceiling, do not damage electrical wiring and other hidden utilities.
- d) Ducted hoods must always be vented to the outdoors.
- e) Do not use this hood with any solid-state speed control device.

▶ To determine whether a ventilation hood may be operated above your cooking appliance, please refer to the information provided by the appliance's manufacturer.

▶ Safety regulations prohibit the installation of a ventilation hood over solid fuel stoves.

▶ An insufficient safety distance between the cooktop and the ventilation hood can result in damage to the ventilation hood.

The minimum safety distances between the top of the cooktop and the bottom of the ventilation hood given in the "Installation" section of this manual must be observed, unless the cooktop manufacturer states that a greater safety distance is required.

If more than one cooking appliance is installed beneath the ventilation hood, and they have different minimum safety distances to the ventilation hood, select the greater distance.

▶ The information provided in "Installation" must be observed when installing the ventilation hood.

▶ Components can have sharp edges which may cause injury. Wear gloves to protect your hands.

IMPORTANT SAFETY INSTRUCTIONS

- ▶ When installing the exhaust duct, only use pipes or tubes made of non-flammable material. These can be obtained from your Miele dealer or from Miele Technical Service. Always observe local building code requirements when selecting duct material.
- ▶ Exhaust air should not be vented into a chimney or vent flue which is otherwise in use and should not be channeled into ducting which ventilates rooms with fuel-burning installations.
- ▶ If exhaust air is to be extracted into a chimney or ventilation duct no longer used for other purposes, seek professional advice.
- ▶ **WARNING: TO REDUCE THE RISK OF FIRE USE ONLY METAL DUCTWORK.**

Cleaning and maintenance

- ▶ There is a risk of fire if cleaning is not completed according to the instructions in this manual.
- ▶ Never use a steam cleaner to clean the ventilation hood. The steam can reach the electrical components and cause a short circuit.

Accessories and parts

- ▶ Use only genuine original Miele parts. If parts or accessories from other manufacturers are used, the warranty may become void.
- ▶ Defective components should be replaced by Miele original parts only. Only with these parts can safety of the appliance be assured as intended by the manufacturer.

FCC Declaration of Conformity

- ▶ These devices comply with FCC Rules Part 15. This equipment has been tested and found to be in compliance with the limits for a Class B digital device, pursuant to Part 15 of the FCC Rules of Operation and is subject to the following conditions:
These devices may not cause harmful interference.
These devices must accept any interference received, including interference that may cause undesired operation.

IMPORTANT SAFETY INSTRUCTIONS

FCC Radiation Exposure Statement

▶ This equipment complies with FCC radiation exposure limits set forth for an uncontrolled environment. This equipment should be installed and operated with minimum distance 8" (20 cm) between the radiator and your body.

Industry Canada Statement

▶ This digital apparatus does not exceed the Class B limits for Radio Noise Emissions from digital apparatus set out in the Radio Interference Regulations of the Canadian Department of Communications.

Complies with Canadian ICES-003 Class B specifications.

Sustainability and environmental protection

Disposal of the packing material

The cardboard box and packing materials protect the appliance during shipping. They have been designed to be biodegradable and recyclable.

Ensure that any plastic wrappings, bags, etc. are disposed of safely and kept out of the reach of children. Danger of suffocation!

Disposal of your old appliance

Electrical and electronic appliances contain valuable materials. They also contain certain substances, compounds and components which were essential for the proper functioning and safe use of the equipment. Handling these materials improperly by disposing of them in your household waste can be harmful to your health and the environment. Therefore, please do not dispose of your old appliance with regular household waste and follow local regulations on proper disposal.



Consult with local authorities, dealers or Miele in order to dispose of and recycle electrical and electronic appliances. Miele assumes no responsibility for deleting any personal data left on the appliance being disposed. Please ensure that your old appliance is kept away from children until removal. Observe safety requirements for appliances that may tip over or pose an entrapment hazard.

Disposal of old batteries and power packs

Electrical and electronic appliances often contain batteries and power packs which must not go into household waste after use. Please remove all accessible batteries and take them to a suitable collection site where they can be collected free of charge. Batteries and power packs may contain substances which are harmful to your health and the environment.

The labeling on the battery or power pack gives further information. The crossed-out trash can means that batteries and power packs must not be disposed of with the household waste. If the crossed-out has one or more of the listed chemical symbols, it contains lead (Pb), cadmium (Cd) and/or mercury (Hg).



Old batteries and power packs contain important raw materials and can be recycled. Separately collecting old batteries and power packs facilitates handling and recycling.

Guide to the ventilation hood

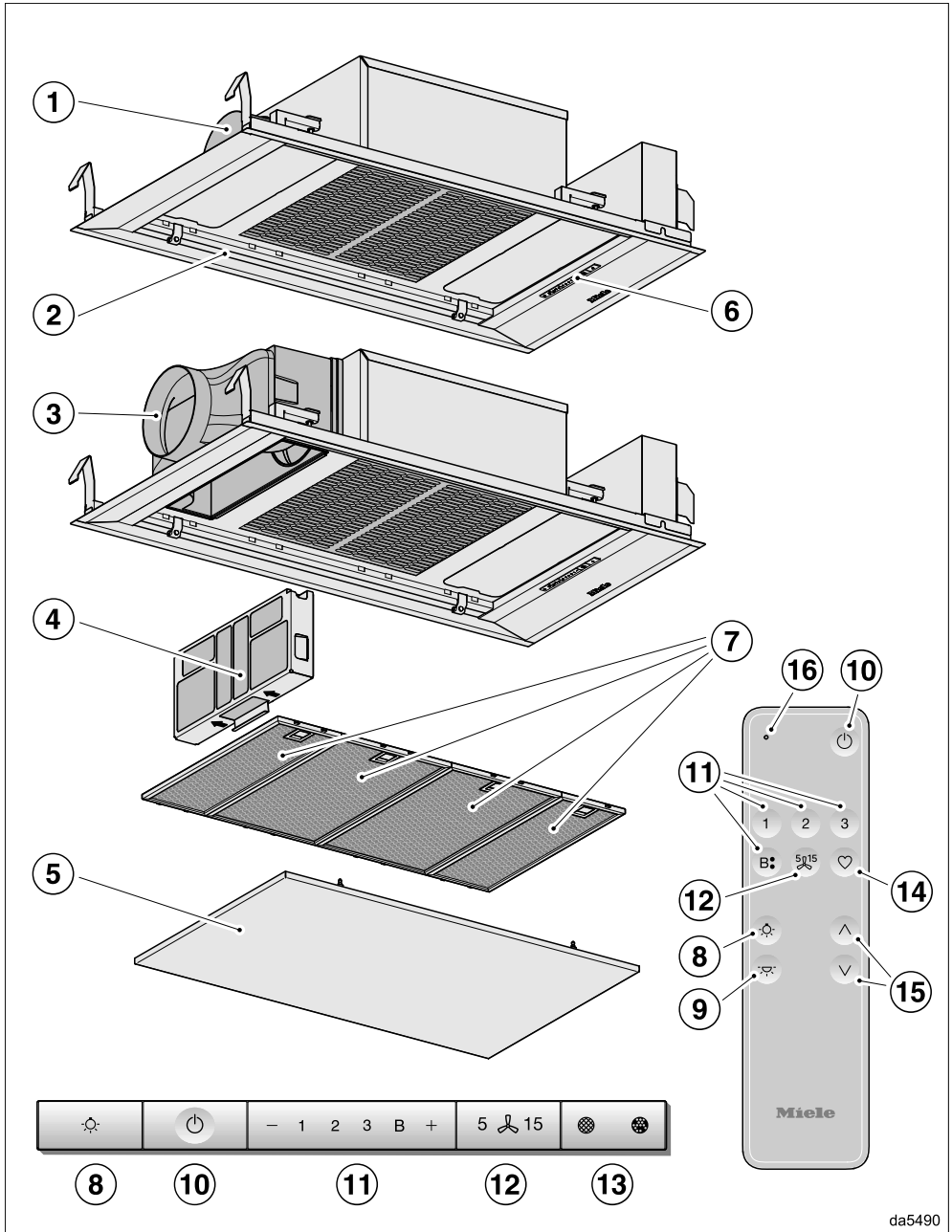

da5490

Familiarization

- ① Exhaust duct
Exhaust air can be directed to the left-hand side, to the rear, or to the front.
- ② Overhead lighting
- ③ Ventilation grille for recirculation mode
- ④ Charcoal filters
Optional accessories for recirculation mode
- ⑤ Edge extraction panel
- ⑥ Controls
- ⑦ Grease filter
- ⑧ Button for switching the lighting on and off
- ⑨ Inoperative control
- ⑩ Control for switching the blower on and off
- ⑪ Controls for setting the blower power
- ⑫ Control for the delayed shutdown function
- ⑬ Control for the filter saturation indicator
- ⑭ Model specific control
- ⑮ Model specific controls
- ⑯ Indicator light

Components

Grease filters and panel

The edge extraction panel and the reusable metal grease filters in the appliance remove solid particles (grease, dust, etc.) from the kitchen vapors, preventing soiling of the ventilation hood.



Risk of fire

Oversaturated grease filters are a fire hazard.

Clean the grease filters at regular intervals.

Heavily soiled grease filters hinder the extraction power and will lead to increased levels of soiling in the ventilation hood and in the kitchen.

Charcoal filter

With recirculation mode and Plug&Play recirculation mode, a charcoal filter must be installed in addition to the grease filters. This filter is designed to absorb cooking odors.

The charcoal filter is available as an optional accessory. It can be reactivated at the end of its operating time.

Overhead lighting

The overhead lighting can be turned on and off separately from the blower.

Functions

Extraction mode



The air is drawn in and cleaned by the grease filters and directed outside.

Recirculation mode

(A charcoal filter is required. Please purchase separately. See “Technical data”.)



The air is drawn in and cleaned first by the grease filters and then by a charcoal filter. The air is then circulated back into the kitchen.

Plug&Play recirculation mode

The air is drawn in and cleaned first by the grease filters and then by a charcoal filter. Without an air duct through the ceiling, the air is then circulated back into the kitchen. Please follow the instructions in “Installation”.

Kitchen ventilation

Ensure that the kitchen is well ventilated when operating the ventilation hood.

In vented mode, the efficiency of the ventilation hood is improved by the incoming air.

In recirculation mode, the moisture produced during cooking remains in the kitchen. Ventilation helps to dissipate moisture.

Blower power levels

Select power levels **1** to **3** for light to heavy cooking vapors, odors, or heat.

Increase the power level as the level of vapors, odors, or heat increases.

For short periods of cooking food with intensive vapors, odors, or heat, e.g., when searing meat, select Booster level **B**. The blower will automatically switch back from the Booster level after 5 minutes.

Delayed shutdown function

The delayed shutdown function enables the blower to continue running for a pre-determined time before switching itself off automatically.

This helps to remove any lingering vapors and odors from the air after cooking. It also reduces the risk of residues accumulating in the ventilation hood and any resulting odors.

Operating hours counter

The ventilation hood registers the length of time for which it has been operated.

When the grease filter symbol  lights up, the grease filters must be cleaned.

When the charcoal filter symbol  lights up, the charcoal filter must be replaced or reactivated (if suitable for reactivating).

You can set the operating hours counter intervals to suit the type of cooking you do.

Deactivate the operating hours counter for the charcoal filter if you are operating the ventilation hood in vented mode.

dsl00494a

dsl00494b

Familiarization

Miele@home

You can connect the ventilation hood to your home Wi-Fi network and operate it using the Miele app on your mobile device.

If your Miele cooktop is also connected to your Wi-Fi network, the Con@ctivity function will be activated automatically.

Con@ctivity

With the Con@ctivity function, the ventilation hood is automatically controlled in conjunction with the cooktop. The ventilation hood and Miele cooktop must be connected to the home Wi-Fi network or have a direct Wi-Fi connection.

The ventilation hood can also be operated manually at any time during automatic operation.

Power management

The ventilation hood is equipped with a power management system. Power management helps to save energy. It ensures that the blower power level is reduced automatically and that the lighting is switched off.



- If the booster level is selected, the blower automatically switches to level 3 after 5 minutes.
- If the blower is set to level 3, 2, or 1, it switches back one blower setting after 2 hours and then in 30-minute intervals until the blower eventually switches off.
- The overhead lighting will switch off automatically after 12 hours.

Settings are made via the ventilation hood control panel, not via the remote control.



Selecting extraction mode or recirculation mode

The ventilation hood can be operated with either extraction mode or recirculation mode. The power of the blower is adapted to suit the selected mode of operation. The ventilation hood is set up at the factory for recirculation mode. The ventilation hood has to be reset for extraction mode.

To reset it for extraction mode, the filter saturation indicator for the charcoal filter(s) has to be deactivated.

- Switch off the blower and the lighting.
- Press the + control and the operating-hours control   at the same time.

The charcoal filter symbol  and one of the blower power level indicators will flash.



- Press and hold the + control until the **B** indicator starts to flash.
- Confirm the selection by pressing the operating-hours control  .

All the indicator lights will go out.

Extraction mode has now been set.

If the selection is not confirmed within 4 minutes, the system will revert to the previous setting.

Activating/deactivating Plug&Play

- Switch off the blower and the lighting.
- Press the delayed shutdown control  for approx. 10 seconds until **1** lights up.
- Then press, in turn:
 - the — control
 - the lighting control  and
 - the lighting control  again

When Plug&Play is deactivated, **1** and **3** will flash.

When Plug&Play is activated, **1** and **3** will light up constantly.

- Press the + control to activate.
1 and **3** will light up constantly.
- Press the — control to deactivate.
1 and **3** will flash.
- Confirm the setting by pressing the delayed shutdown control .

All the indicator lights will go out.

Commissioning

Setting up Miele@home

Prerequisites:

- A Wi-Fi network
- The Miele app
- A Miele user account. You can create a user account via the Miele app.

Before installing the ventilation hood in its final location, ensure that the signal of your WiFi network is strong enough.

Miele@home availability

The ability to use the Miele app depends on the availability of the Miele@home service in your country.

The Miele@home service is not available in every country.

For information about availability, please visit www.miele.com.

Performing Scan & Connect

- Scan the QR code.

If you have installed the Miele app and have a user account, you will be taken directly to the networking steps.

If you have not yet installed the Miele app, you will be taken to the Apple App Store® or the Google Play Store™.

- Install the Miele app and set up a user account.
- Scan the QR code again.

The Miele app will guide you through the setup process.



Signing off Wi-Fi and remote control

To set up a new Wi-Fi connection or a connection with a remote control, the existing connections must be disconnected first.

The sign-off process will always sign off the Wi-Fi and a connected remote control at the same time.

- Switch the ventilation hood off.
- Press and hold the — control.
- Touch the lighting control  at the same time.



With an existing Wi-Fi connection, **2** and **3** will light up constantly.

If a remote control is signed on, **B** will also light up.

- Touch the — control.

2 will light up constantly, **3** will flash on and off.

After a few seconds, **2** and **3** will flash on and off. The connection has now been disconnected.

- Quit disconnection mode on the ventilation hood by pressing the delayed shutdown control ⁵¹⁵.
- Press the **B** and  controls on the remote control at the same time.

All connections have been disconnected. You can establish a new connection.

Setting up Con@ctivity

Activating Con@ctivity 3.0 via the home Wi-Fi network

Prerequisites:

- Home Wi-Fi network
- Wi-Fi-enabled Miele cooktop

- Connect the ventilation hood and cooktop to your home Wi-Fi network (see “Setting up Miele@home”).

The Con@ctivity function will be activated automatically.

Activating Con@ctivity 3.0 via a direct Wi-Fi connection

Rather than connecting to the home network, you can establish a direct connection between the cooktop and the ventilation hood.

Prerequisite:

- Wi-Fi-enabled Miele cooktop

- Switch the ventilation hood off.
- Press and hold the + control.
- Press the — control at the same time.

2 will light up constantly, **3** will flash on and off.

The ventilation hood will be ready for connection for the next 2 minutes.

- Start the Wi-Fi connection on the cooktop. For more details, see the cooktop operating instructions.

When successfully connected, **2** and **3** will light up constantly.

- Quit connection mode on the ventilation hood by pressing the delayed shutdown control ⁵¹⁵.

Con@ctivity has now been activated.

Commissioning

With a direct Wi-Fi connection, it is not possible to connect the cooktop and the ventilation hood to a home network. Should this be required at a later date, the direct Wi-Fi connection between the cooktop and the ventilation hood must be disconnected first (see “Signing out of Wi-Fi”).

Reattempting the connection

If it is not possible to connect, **2** and **3** flash or the ventilation hood cancels the process.

- Disconnect the connection to the ventilation hood (see “Signing out of Wi-Fi”) **and** to the cooktop.
- Attempt to make the connection again.

Preparing the remote control

- Insert the batteries into the remote control; see “Cleaning and care – Inserting/replacing batteries”.

Signing on the remote control

- Press and hold the **+** control on the ventilation hood for approx. 10 seconds.

2 will light up constantly, **3** will flash on and off.

- Press the **1** and **3** controls on the remote control at the same time until the indicator starts flashing red.

The sign-on process starts.

The indicator light will briefly flash green if the sign-on process is successful.

2 and **3** will light up constantly on the ventilation hood.

- Confirm the setting on the ventilation hood with the delayed shutdown control ⁵ ↵¹⁵.

If the sign-on process was not successful, **2** and **3** will flash.

- In this case, repeat the process.

Signing off the remote control

- For information about the sign-off process, see “Commissioning – Signing off Wi-Fi and remote control”.

Cooking with Con@ctivity over an electric cooktop

- Switch on a cooking zone at any power level.

The overhead lighting will come on.

After a few seconds, the blower will come on, briefly operating at power level **2** before switching to level **1**.

The ventilation hood selects the required blower power level automatically during cooking. The power level selected by the ventilation hood depends on the number of cooking zones being used and their power levels.

The ventilation hood responds with a delay. This takes into account the fact that changing the power level at the cooktop does not increase or decrease the cooking vapors straight away.

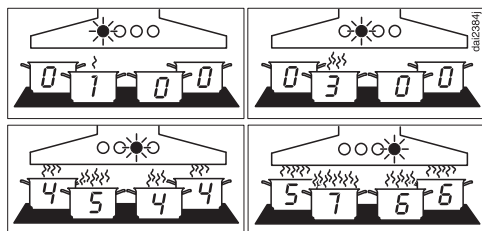

Examples for blower levels **1** to **B**

- Switch off all cooking zones after cooking.

Over the next few minutes, the ventilation hood blower setting will decrease one level at a time until the hood eventually turns off.

This helps to neutralize any lingering vapors and odors in the air.

After another 30 seconds, the overhead lighting turns off.

Frying with Con@ctivity

- For example, you switch on a cooking zone at the highest power level to heat cookware for frying. You reduce the power level after approx. 10 seconds to 4 minutes (60 seconds to 5 minutes for a HiLight cooktop).

The ventilation hood recognizes a cooking process.

The ventilation hood turns itself on and when the cooktop power level has been reduced, the ventilation hood switches to power level 3 and remains at that level for approx. 5 minutes.

After this, the blower level is once again determined by the Con@ctivity function.

You can also manually select a different blower level before then.

Cooking with Con@ctivity over a gas cooktop

- Switch on a burner at any power level.

The overhead lighting will come on.

After a few seconds, the blower will come on at power level **2**.

Regardless of the selected cooking level, the blower remains at power level **2**.

- Switch off all burners after cooking.

The delayed shutdown function is activated. The **5** on the delayed shutdown control ⁵ will light up.

After 5 minutes, the blower and the overhead lighting will switch off.

This helps to neutralize any lingering vapors and odors in the air.

Operation (automatic)

Temporarily exiting Automatic mode

To exit Automatic mode temporarily:

- Manually select a different blower power level, or
- Manually switch the ventilation hood off, or
- Activate the delayed shutdown function ⁵, or
- Operate the overhead lighting (only in combination with a gas cooktop)

If you switch off the blower manually in Plug&Play mode, it continues to run at level 1 (see “Operation (Manual mode) – Switching off the blower”).

Resuming Automatic mode

In combination with an electric cooktop:

- If the ventilation hood has not been used for a period of approx. 5 minutes after the manual selection of a blower level; or
- If the manually selected blower level once again matches the automatic setting; or
- The ventilation hood blower and the cooktop have been switched off for at least 30 seconds.
Automatic mode will resume next time the cooktop is switched on.

In combination with a gas cooktop:

- The ventilation hood blower and the cooktop have been switched off for at least 30 seconds.
Automatic mode will resume next time the cooktop is switched on.

Exiting Automatic mode for the entire cooking process

- Switch the blower on **before** the cooktop.

Con@ctivity is deactivated until the ventilation hood is switched off.

If the ventilation hood and the cooktop have been switched off for at least 30 seconds after cooking, Automatic mode will resume next time the cooktop is switched on.

Cooking without Con@ctivity (Manual mode)

The ventilation hood can be operated manually if:

- The Con@ctivity function is not activated.
- You have temporarily deactivated the Con@ctivity function (see “Operation (Automatic mode) – Temporarily exiting Automatic mode”).

Turning on the blower

- Press the On/Off control .

The blower switches on at power level **2**.





Selecting the power level

- Use the **–** and **+** controls on the ventilation hood or the **1**, **2**, **3**, and **B** controls on the remote control to select the power level required.

Reducing power down from the Booster level

The blower automatically switches back to power level **3** after 5 minutes.

Selecting the delayed shutdown time

- After you have finished cooking, press the delayed shutdown control  while the blower is still running:
 - Once: The blower switches off after 5 minutes ( lights up).
 - Twice: The blower switches off after 15 minutes ( lights up).
 - If you touch the delayed shutdown control  again, the blower will remain switched on ( will go out).

Turning off the blower

- Press the On/Off control  to turn the blower off.

The  symbol will go out.

Delayed shutdown in Plug&Play operation

If you switch off the blower in Plug&Play mode, it will run on at level **1**. Delayed shutdown ensures that the ceiling is ventilated after cooking.

Depending on the last active blower level, delayed shutdown lasts between 2 and 30 minutes.

You can switch off the blower immediately during delayed shutdown by pressing **1** or the On/Off switch .

This function is independent of the delayed shutdown function .

Turning the overhead lighting on/off

- Press the lighting control  to switch it on or off.

Customizing settings



Settings are made via the ventilation hood control panel, not via the remote control.

Intervals for the grease filter operating hours counter

The factory default setting is a cleaning interval of 30 hours.

- Select a shorter interval of 20 hours if you fry food regularly.
- A shorter cleaning interval is also recommended if you only cook occasionally. This will prevent grease buildup from hardening and making cleaning more difficult.
- Select a longer interval of 40 or 50 hours if you use very little fat for cooking.

Changing the intervals for the grease filter operating hours counter

- Switch off the blower and the lighting.
- Press the delayed shutdown control  and the operating hours control  at the same time.

The grease filter symbol  and one of the blower power level indicators will flash.

The indicators **1** to **B** show the current time setting:

- Indicator **1** 20 hours
- Indicator **2** 30 hours
- Indicator **3** 40 hours
- Indicator **B** 50 hours

- Press the **-** button for a shorter duration, or **+** for a longer duration.
- Confirm the selection by pressing the operating hours control .

All the indicator lights will go out.

If the selection is not confirmed within 4 minutes, the system will revert to the previous setting.

Intervals for the charcoal filter operating hours counter

The factory default setting is an interval of 180 hours.

- If you frequently cook dishes with strong odors, it is recommended to shorten the interval to 120 hours.
- If you rarely cook dishes with strong odors, you can extend the interval to 240 hours.

Altering or deactivating the charcoal filter operating hours counter intervals

- Switch off the blower and the lighting.
- Press the **+** control and the operating hours control  at the same time.

The charcoal filter symbol  and one of the blower power level indicators will flash.

The indicators **1** to **B** show the current time setting:

- Indicator **1** 120 hours
- Indicator **2** 180 hours
- Indicator **3** 240 hours
- Indicator **B** deactivated



- Press the **+** or **-** control to select the required duration.
- Confirm the selection by pressing the operating hours control .

All the indicator lights will go out.

If the selection is not confirmed within 4 minutes, the system will revert to the previous setting.

Activating/deactivating power management

Keep in mind that deactivating this function may increase energy consumption.

- Switch off the blower and the lighting.
- Press the delayed shutdown control  for approx. 10 seconds until **1** lights up.
- Then press, in turn:
 - the lighting control 
 - the — control, and then
 - the lighting control 



When power management is activated, **1** and **B** light up constantly.

When it is deactivated, **1** and **B** flash.

- Press the — control to deactivate power management.
1 and **B** will flash.
- Press the + control to activate power management.
1 and **B** will light up constantly.
- Confirm the setting by pressing the delayed shutdown control .

Safety shut-off

If power management has been deactivated, the ventilation hood will switch itself off automatically after 12 hours if it has been left on (blower and overhead lighting).

- To switch it back on, press the On/Off  control or the lighting control .

Energy-saving tips

This hood operates in a very efficient and energy-saving manner. The following will help you to save even more energy when using it:

- Ensure that there is sufficient ventilation in the kitchen when cooking. If there is insufficient air flow during extraction mode, the hood cannot operate efficiently, causing increased operating noise levels.
- Always cook with the lowest possible setting. This produces fewer cooking vapors so that you can use a lower hood power level and therefore benefit from reduced energy consumption.
- Clean or change the filters at regular intervals. Heavily soiled filters reduce performance, increase the risk of fire and are unhygienic.
- Use the Con@ctivity function. The ventilation hood will switch on and off automatically. The ventilation hood will select the optimum power level for the cooking you are doing, which ensures low energy consumption.
- If you are operating the ventilation hood manually, please note the following:
 - Check the power level selected on the ventilation hood. A low power level is usually sufficient. Only use the Booster setting when necessary.
 - When a large volume of cooking vapors are being produced, switch to a high power level in good time. This is more efficient than operating the hood for longer to try to capture cooking vapors that have already been distributed throughout the kitchen.
 - Make sure that you switch off the hood after use. If cooking vapors and odors still need to be removed from the kitchen air after cooking, use the delayed shutdown function. The blower will switch off automatically after the selected delayed shutdown time.

 Before proceeding with any maintenance or cleaning task, the ventilation hood must be disconnected from the power supply, see "IMPORTANT SAFETY INSTRUCTIONS".

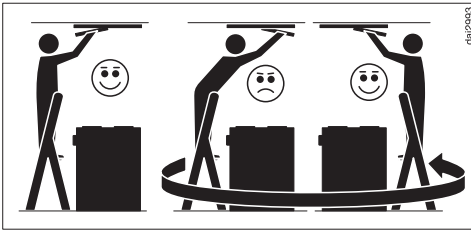

 When cleaning the ventilation hood, please note the following:
Use a stable ladder.
Make sure that you have a secure footing on the ladder.
Do not lean over the cooktop.
Do not stand on the countertop or the cooktop.

Cleaning the casing

- Clean all surfaces and control elements with a sponge cloth and a solution of warm water and liquid dish soap.
- Remove the grease filters and clean any grease residues from the accessible parts of the casing. Doing so will prevent a fire hazard.
- After cleaning, wipe the surfaces dry using a soft cloth.
- In addition, stainless steel surfaces can be cleaned using a non-abrasive stainless steel cleaner (not suitable for the controls).
To prevent the surfaces from quickly becoming dirty again, it is

recommended to treat them with a stainless steel care product (available from Miele).

Important information on cleaning the casing

Unsuitable cleaning agents can damage the surfaces.

Do not use any of the following cleaning agents:

- cleaning agents containing soda, acids, chlorides, or solvents
- abrasive cleaning agents, e.g., powder cleaners, cream cleaners, and abrasive sponges, as well as pot scourers or sponges which have been used previously with abrasive cleaning agents

Minor scratches on the surface are inevitable when cleaning colored parts of the casing; they may be visible depending on the lighting in the kitchen.

Grease filters and edge extraction panel

Cleaning interval for grease filters and panel

After a preset operating time, the grease filter symbol  will light up to remind you to clean the grease filters and the panel.

Clean the grease filters and the panel every 3 to 4 weeks at the latest, even if the grease filter symbol  has not lit up yet. Accumulated grease solidifies over a longer period of time and makes cleaning more difficult.

Cleaning and care

Condensation on the panel

Condensation forms on the panel during cooking and evaporates once cooking is complete. Wait approximately 2 hours after finishing cooking before removing the panel. This will allow time for the condensation to evaporate and avoid dripping water.

Removing the panel and grease filters

⚠ If the panel or a grease filter falls down, this can result in damage. Make sure you hold the panel and filters securely at all times when handling them.

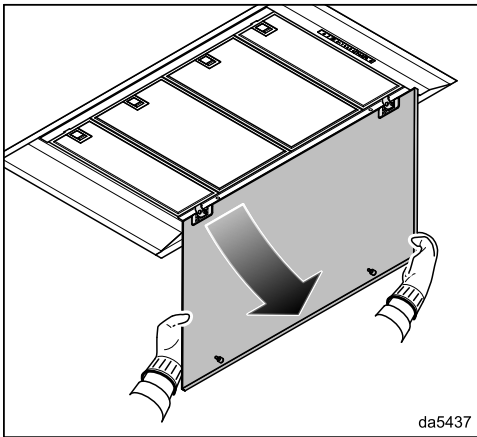

- Pull the front edge of the panel down out of the locking clip and lower it.

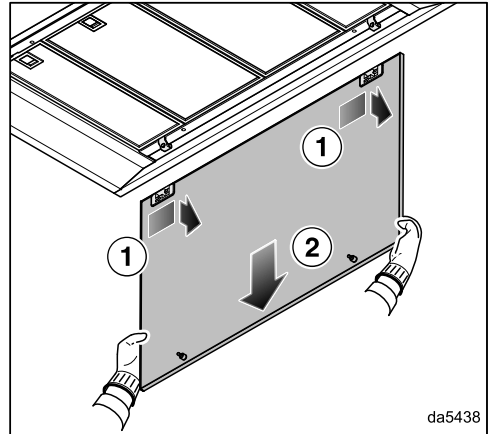

- Push the panel slightly to the right, then remove it by pulling it out to the rear.

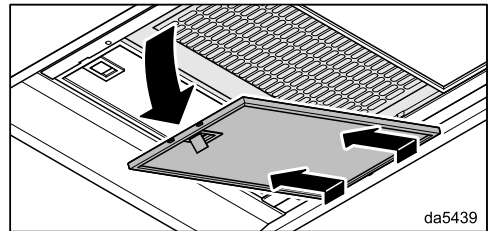

- Release the locking clip on the grease filter and lower the filter by approx. 45°. Unhook the grease filter and remove it.

Cleaning the panel

- For cleaning purposes, follow the instructions provided under “Cleaning the casing”.

Cleaning the grease filters by hand

- Clean the grease filters with a soft nylon brush in a mild solution of hot water and a little liquid dish soap. Do not use concentrated dish soap.
- After cleaning, place the filters on a towel to air dry.

Important information on cleaning by hand

Unsuitable cleaning agents may damage the filter surfaces if used regularly. Do not use any of the following cleaning agents:

- cleaning agents containing descaling agents
- powder cleaners and cream cleaners
- aggressive all-purpose cleaners and degreasing sprays
- oven sprays

Cleaning the grease filters in the dishwasher

- Place the grease filters upright or slightly inclined in the lower basket. Ensure the spray arm is not obstructed.
- Use a standard household cleaning agent.
- Select a program with a maximum wash temperature of 150°F (65°C).

Important information on cleaning in a dishwasher

Excessively high temperatures can render the grease filters unusable (due to being warped out of shape, for example). Select a program that does not exceed the recommended temperature.

Also follow the information provided in the operating instructions for the dishwasher.

Depending on the cleaning agent used, the internal filter surfaces may become discolored. However, this will not affect the functioning of the grease filters in any way.

Inserting the grease filters

- Insert the grease filters. When inserting the grease filters, make sure that the locking clip is facing outward.

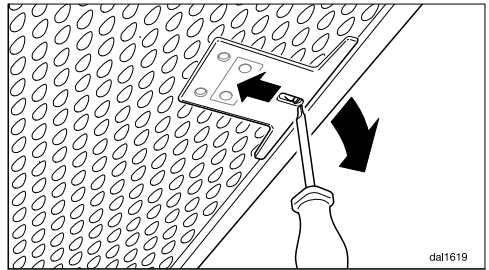

- If the grease filters were inadvertently inserted upside down, insert a small screwdriver blade into the slit to disengage the clip.

Cleaning and care

Inserting the panel

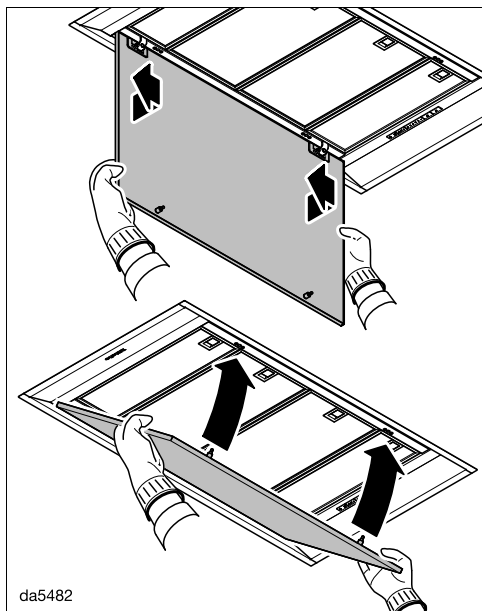

- Hook the panel into the hinges from behind and slide the panel to the left.
- Lift the panel upward and press it into the locking clips.

Resetting the grease filter operating hours counter

After cleaning, the operating hours counter needs to be reset via the controls on the ventilation hood.

- With the blower switched on, press the operating hours control  for approximately 3 seconds until only **1** is flashing.

The grease filter symbol  goes out.

When cleaning the grease filters before the full operating time has elapsed:

- Press the operating hours control  for approximately 6 seconds until only **1** is flashing.

Replacing the grease filters

Regular usage and cleaning can cause the filter surfaces to become worn or brittle.

If you identify any damage, replace the grease filters.

Grease filters are available to order via Miele Service (see end of these operating instructions for contact details) or from your Miele dealer.

OdorFree Charcoal Filter

Reactivation interval for the charcoal filter

Keep in mind that only charcoal filters with the model number Miele DKF ...-R are reactivatable.

Reactivate the charcoal filter when it no longer absorbs kitchen odors effectively.

After an operating time of 180 hours, the charcoal filter symbol  will light up to remind you to reactivate the charcoal filter.

It is recommended to reactivate the charcoal filter after 6 months at the latest.

Installing/replacing the charcoal filter

- Remove the panel and the grease filters.
- Remove the charcoal filter from its packaging.

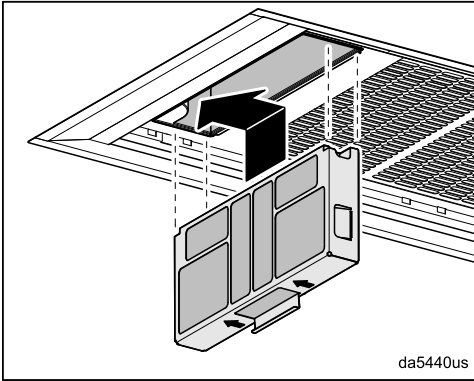

- Insert the charcoal filter into its compartment and push it to the left into the holder.
- Reinsert the grease filters and the panel.

Resetting the charcoal filter operating hours counter

After changing or reactivating the charcoal filter, the operating hours counter needs to be reset.

- To do this, with the blower switched on, press the operating hours control  twice, then hold it for approx. 3 seconds, until only **1** is flashing.

The charcoal filter symbol  will go out.

If you want to replace or reactivate the charcoal filter **before** the full operating time elapses:

- Press the operating hours control  twice and hold it for approximately 6 seconds until only **1** is flashing.

Disposing of charcoal filters

- Used charcoal filters can be disposed of with normal household waste.

Remote control

Inserting/replacing batteries

The remote control requires 2 batteries, 1.5 V, type AAA. The batteries are supplied with the remote control and must be inserted before using for the first time.

The batteries must be replaced if ventilation hood functions can no longer be selected using the remote control. The indicator light on the remote control no longer lights up or only lights up weakly when a button is pressed. Ventilation hood functions can still be selected using the controls on the ventilation hood.

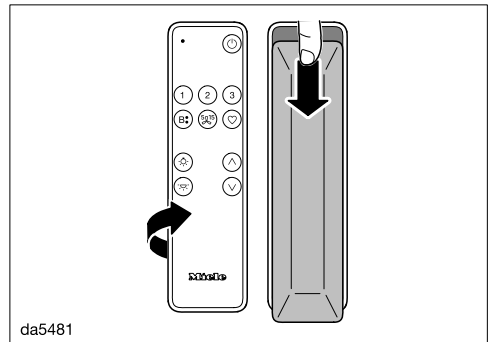

- Slide the cover on the back down slightly and remove it.
- Insert the batteries. Make sure the polarity is correct.
- Replace the cover and slide it upward.

Cleaning the remote control

- The surface should **only** be wiped with a damp cloth. Do not use too much water to prevent moisture getting into the casing.

Customer Service

Information to help you rectify faults yourself and about Miele spare parts can be found at www.miele.com/service.

Contact in the event of a fault

In the event of a fault which you cannot remedy yourself, please contact your Miele dealer or Miele Customer Service.

You can book a Miele Service Call online at www.miele.com/service.
Contact information for Miele Customer Service can be found at the end of this document.

Please quote the model identifier and serial number of your appliance (SN) when contacting Miele Customer Service. Both pieces of information can be found on the data plate.

Location of the data plate

The data plate is visible once you have removed the grease filters.

Appliance warranty and product registration

You can register your product and/or view the manufacturer's warranty terms and conditions for Miele appliances and vacuum cleaners at www.mieleusa.com.

Before installation

 Before installation, it is important to read the information contained in this chapter and in the "IMPORTANT SAFETY INSTRUCTIONS" chapter.

Information is subject to change. Please refer to our website to obtain the most current product specification, technical & warranty information.

Removing the protective film

The housing components are covered by a protective film to prevent them from damage during transport.

- Please remove this film before installing the housing components. It can be peeled off easily without any additional tools.

Coating the panel

The visible surfaces of the edge extraction panel can be coated for decoration.

The surfaces can be laminated, varnished, or painted.

When selecting the coating, keep in mind that the panel is exposed to heat, moisture, and soiling from the rising vapors.

Coatings are not recommended when the panel is installed over a gas cooktop due to the high temperatures involved. Have specialists carry out the coating process.

Clean the panel at regular intervals.

Follow the cleaning instructions provided by the manufacturer of the coating used.

Miele does not guarantee the durability of the coating.

Installation materials

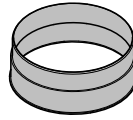

1 vent collar
for exhaust ducting \varnothing 6" (150 mm)

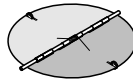

1 non-return flap
for installing into the exhaust vent on the motor (not needed for recirculation mode).

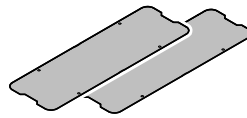

2 lids

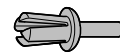

8 rivets
for securing the lids.

08565780

08272520

12454670

12623460

Installation

Appliance dimensions

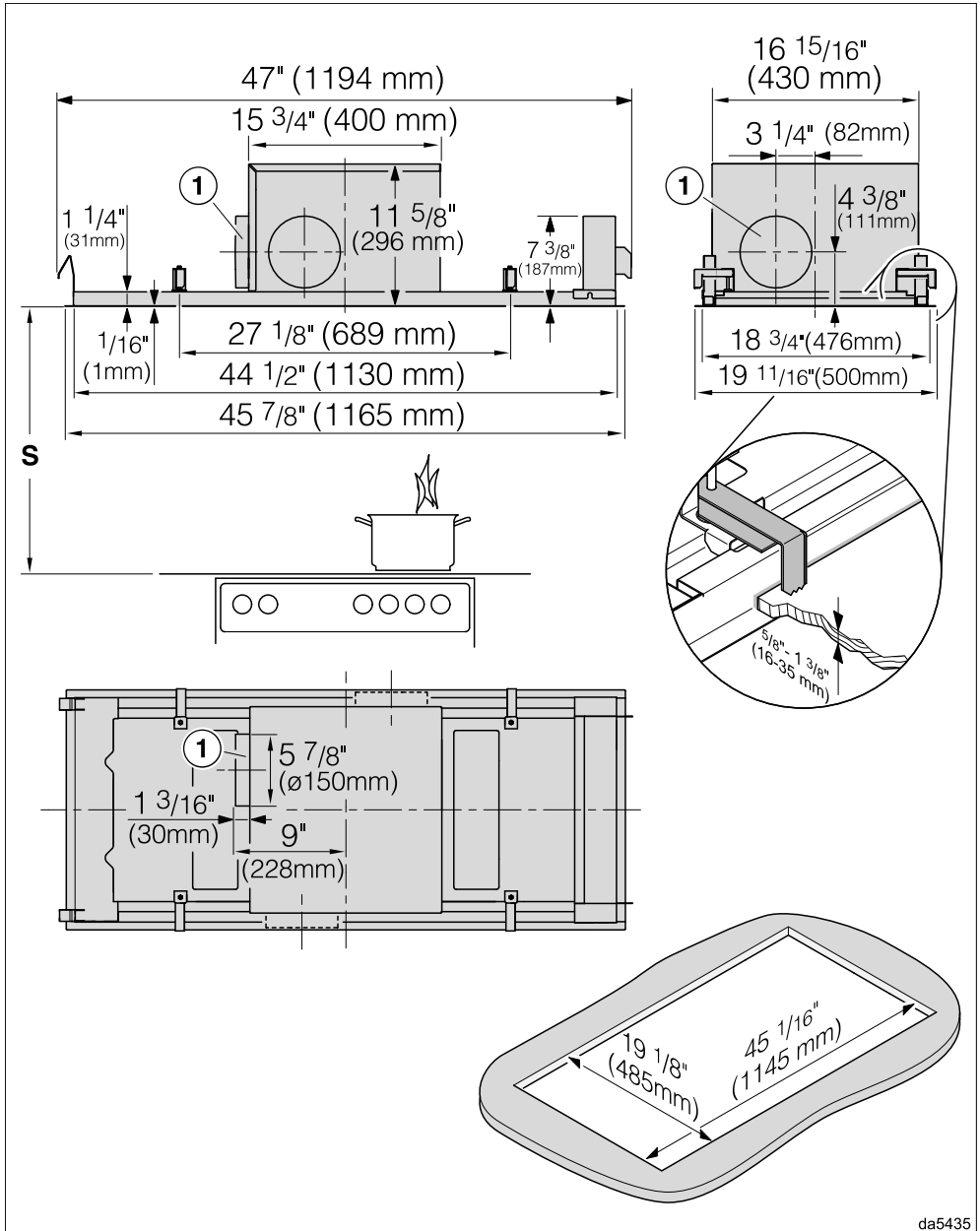

da5435

DAC 2247 in vented mode

Installation

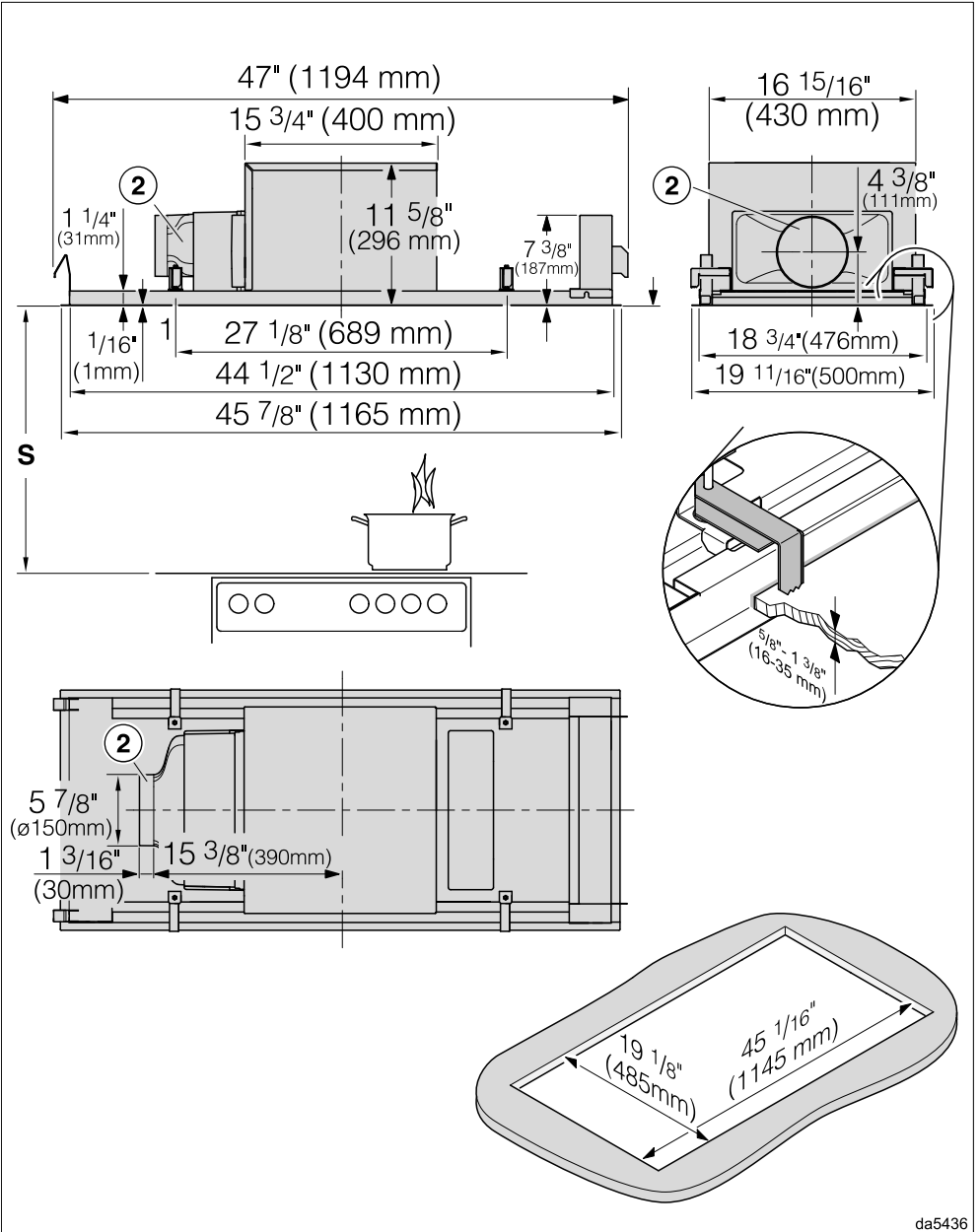

da5436

DAC 2247 in recirculation mode and Plug&Play recirculation mode

Installation

① Exhaust duct Ø 6" (150 mm)

The duct is installed on the left-hand side at the factory.

- If you want to install the duct at the front or rear, you can rotate the blower casing by 90° during installation. To rotate the casing, there must be a clearance of 4" (100 mm) in the ceiling in front of and behind the ceiling cut-out.
- If you want to install the duct on the right-hand side, rotate the ventilation hood by 180° during installation. To ensure that the panel still opens to the front, you must convert the panel hinges.

② Duct Ø 6" (150 mm), as air vent in Plug&Play mode or for the connection of an air duct in ducted recirculation mode

The duct is installed on the left-hand side at the factory.

- It is not possible to convert the duct to the front or rear.
- If you want to install the duct on the right-hand side, rotate the ventilation hood by 180° during installation. To ensure that the panel still opens to the front, you must convert the panel hinges.

The required installation steps are described in the installation sheet.

Distance between cooktop and ventilation hood (S)

Provided a larger distance is not given by the manufacturer of the cooktop, follow the minimum safety distances between a cooktop and the bottom of the hood.

Please also observe the information contained in the “IMPORTANT SAFETY INSTRUCTIONS” section.

Cooking appliance	Minimum distance S	
	Miele appliance	Non-Miele appliance
Electric Cooktops	24" (610 mm)	
Electric Barbeques and Fryers	26" (660 mm)	
Multiburner Gas Cooktops ≤ 43,000 BTU/hr (12.6 kW), no burner > 15,000 BTU/hr (4.5 kW).	26" (660 mm)	30" (760 mm)
Multiburner Gas Cooktops ≤ 73,800 BTU/hr (21.6 kW), no burner > 16,500 BTU/hr (4.8 kW)	30" (760 mm)	
Multiburner Gas Cooktops > 73,800 BTU/hr (21.6 kW), or one of the burners > 16,500 BTU/hr (4.8 kW)	Not possible	
Single Burner Gas Cooktops ≤ 20,500 BTU/hr (6 kW)	26" (660 mm)	30" (760 mm)
Single Burner Gas Cooktops > 20,500 BTU/hr (6 kW) ≤ 27,600 BTU/hr (8.1 kW)	30" (760 mm)	
Single Burner Gas Cooktops > 27,600 BTU/hr (8.1 kW)	Not possible	

Installation

Installation notes

- A minimum distance of $27 \frac{9}{16}$ " (700 mm) and a maximum distance of $51 \frac{3}{16}$ " (1,300 mm) is recommended between the cooktop and the ventilation hood.

Please be aware that if positioned too high, vapor extraction will be inefficient.

- To achieve optimum vapor extraction, the ventilation hood must be centered over the cooktop, not to the side or behind it.

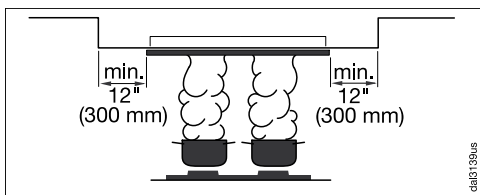

- If the ventilation hood is being installed in a suspended ceiling, the installation surface all around the ventilation hood must be at least 12" (300 mm) larger than the ventilation hood itself.
- As far as possible, the cooktop should be narrower than the ventilation hood. At a maximum, the cooktop should be the same width.
- The ventilation hood must also be freely accessible and located such that it can be dismantled in the event of future service requirements. This should be taken into consideration when planning the position of cupboards, shelves, ceilings, or decorative features in the vicinity of the ventilation hood.
- The ventilation hood is fastened in the cut-out using clamps. A solid installation surface, e.g., made of wood, is required. Make sure that the

structure can support the load.

Around the clamps, components such as supports and ducting must be at least 1" (25 mm) from the cut-out.

- If you install the appliance in a place that is used on a daily basis, e.g., in a cabinet, the top of the appliance must not be accessible. Close the installation space in the cabinet, e.g., with additional walls and shelves.

Plug&Play mode

- The air must be able to circulate freely into the ceiling. Components in the ceiling must be at least 12" (300 mm) away from the exhaust ducting.
- Ensure sufficient ventilation of the ceiling area, e.g., through exhaust grilles, gaps, or shadow gaps. The cross-section of the openings must be at least 600 cm² in total.
- The ceiling and adjacent walls that come into contact with the exhaust air must not exceed a heat transfer coefficient of 0.5 W/(m²K).
- The electronic for vapor extraction must be switched to Plug&Play mode; see "Commissioning", "Activating/Deactivating Plug&Play".

Air venting

WARNING: Danger of toxic fumes. Gas cooking appliances release carbon monoxide that can be harmful or fatal if inhaled.

To reduce the risk of fire and to properly exhaust air, the exhaust gases extracted by the hood should be vented outside of the building only.

Do not vent exhaust air into spaces within walls or ceilings or in attics, crawl spaces or garages.

To reduce the risk of fire, only use metal ductwork.

Please read and follow the "IMPORTANT SAFETY INSTRUCTIONS" to reduce the risk of personal injury. Follow all local building codes when installing the hood.

Only use smooth pipes or flexible ducting made from approved non-flammable materials for ducting.

To achieve the most efficient air throughput with the lowest noise levels, please note the following:

- The diameter of the vent ducting must not be smaller than the cross-section of the vent collar (see "Appliance dimensions"). This applies in particular when using flat ducting.
- The ducting should be as short and straight as possible.
- Only use wide radius bends.
- The ducting must not be kinked or compressed.
- All connections must be strong and airtight.

- If the ducting has flaps, these must be opened whenever the ventilation hood is switched on.

Any constriction of the air throughput will reduce extraction performance and increase operating noise.

Ventilation stack

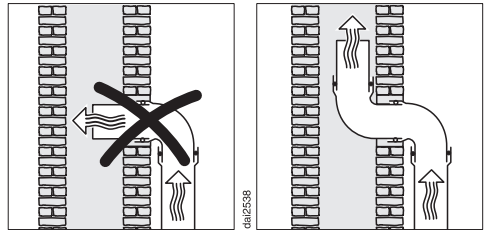

If the exhaust air is to be ducted into a flue, the ducting must be directed in the flow direction of the flue.

If the flue is used by several ventilation units, the cross-section of the flue must be large enough.

Non-return flap

- Use a non-return flap in the vent system.

A non-return flap ensures that when the ventilation hood is not in operation, the duct is closed to prevent unwanted exchange of room air and outside air.

If the exhaust is ducted through an outside wall, a Miele wall vent or roof vent (available as an optional accessory) is recommended. Both of these have a built-in non-return flap.

If the on-site vent system does not have a non-return flap, one is supplied with the ventilation hood.

The non-return flap is installed in the exhaust socket of the fan.

Installation

Condensate

If the ducting is to run through cool rooms or ceiling space, for example, the significant variations in temperature between the different areas can cause condensate to form. Insulate the ducting to reduce temperature variations.

If the ducting is to be laid horizontally, it must be laid with a downwards sloping gradient of at least $\frac{3}{8}$ " (1 cm) per meter. This is to ensure that condensate cannot drain back into the ventilation hood.

Miele will not accept warranty claims for any functional defects or damage caused by inadequate ducting.

Reducing Collar

(optional accessory)

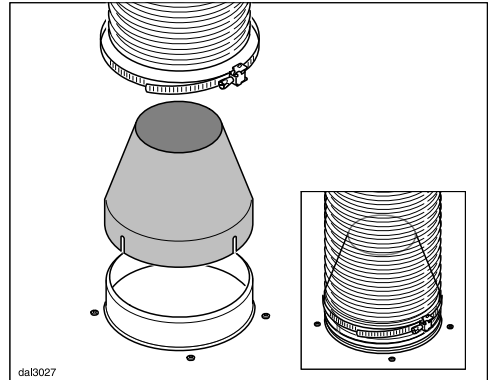

If you would like to reduce the environmental impact of your ventilation system by limiting the CFM output the Reducing Collar can be installed. It reduces the air flow to less than 400 CFM. Check local building codes for max. CFM requirements.

- Push the Reducing Collar on the exhaust port of the blower.
- Push the exhaust hose over it.
- Secure both with a hose clamp.

Electrical connection

WARNING: TO REDUCE THE RISK OF FIRE, ELECTRIC SHOCK, OR INJURY TO PERSONS, OBSERVE THE FOLLOWING:

All electrical work should be performed by a qualified electrician in strict accordance with national regulations (for USA: ANSI-NFPA 70) and local safety regulations. Installation, repairs and other work by unqualified persons could be dangerous.

Ensure that power to the appliance is OFF while installation or repair work is performed.

Verify that the voltage, load and circuit rating information found on the data plate (see "Technical Service"), match the household electrical supply before installing the hood.

Use only with ventilation hood cord-connection kits that have been investigated and found acceptable for use with this model hood.

If there is any question concerning the electrical connection of this appliance to your power supply, please consult a licensed electrician or call Miele's Technical Service Department.

WARNING: THIS APPLIANCE MUST BE GROUNDED

Grounding Instructions

WARNING - Improper grounding can result in a risk of electric shock.

This appliance must be grounded. In the event of an electrical short circuit, grounding reduces the risk of electric shock by providing a path of least resistance. This appliance is equipped with a cord having a grounding wire with a grounding plug.

If there is any doubt, have the electrical system of the house checked by a qualified electrician.

Do not use an extension cord. If the power supply cord is too short, have a qualified electrician install an outlet near the appliance.

- The plug must be plugged into an outlet that is properly installed and grounded.

WARNING - Grounding instructions (Canada)

The grounding-type attachment plug shall be connected to a grounding-type receptacle installed in accordance with CSA C22.1-12, Canadian Electrical Code, Part I.

Technical data

Blower motor	180 W
Overhead lighting	2 x 7.2 W
Total rated load	194.4 W
Light temperature for the overhead lighting	3,500 K
Voltage, frequency	120 V AC, 60 Hz
Fuse rating	10 A
Power supply cord length	2.3 ft (0.7 m)
Weight	49.1 lbs (22.3 kg)

WiFi module

Frequency range	2.400–2.4835 GHz
Maximum transmission power	< 100 mW

Optional accessories for recirculation mode

DKF 40-R charcoal filter (reactivatable)



WiFi module EK058

FCC ID: 2AC7Z-EK058

IC: 21098-EK058

This device complies with Part 15 of the FCC Rules and with Industry Canada licence-exempt RSS standard(s). Operation is subject to the following two conditions: (1) this device may not cause harmful interference, and (2) this device must accept any interference received, including interference that may cause undesired operation.

da004081

Please have the model and serial number of your appliance available when contacting Customer Service.

U.S.A.

Miele, Inc.

National Headquarters

9 Independence Way
Princeton, NJ 08540
www.mieleusa.com

Customer Support

Phone: 888-99-MIELE (64353)
info@mieleusa.com

International Headquarters

Miele & Cie. KG
Carl-Miele-Straße 29
33332 Gütersloh
Germany

Canada

**Importer
Miele Limited**

Headquarters and Miele Centre

161 Four Valley Drive
Vaughan, ON L4K 4V8
www.miele.ca

Customer Care Centre

Phone: 1-800-565-6435
905-532-2272
customercare@miele.ca

DAC 2247

en-US

M.-Nr. 12 574 570 / 01